

FY14 ANNUAL PROGRESS REPORT

Laboratory Directed Research and Development

Los Alamos National Laboratory



 **Los Alamos**
NATIONAL LABORATORY
EST. 1943

This page intentionally left blank.

About the Cover

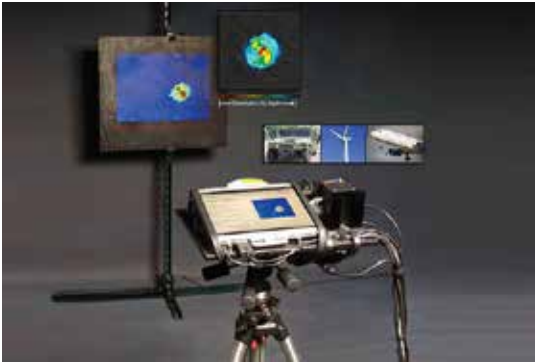

The cover shows the Acoustic Wavenumber Spectroscopy (AWS) system scanning a 600-mm by 7-mm-thick carbon-fiber-reinforced polymer panel. The panel had been subjected to projectile impact that induced internal delamination of the composite layers without any visible indications of damage to the external surface. AWS generates nondestructive evaluation (NDE) results live during a scan, projecting them back onto the panel just behind the horizontal laser scan line (seen in red) as it is swept from top to bottom. The graphic shows a zoomed region of the final NDE result after automated thresholding and scaling. The color indicates the relative ply depth of the delamination, with red being closest to the scan surface. Start to finish, the entire scan takes less than

eight seconds. AWS applications (as shown on the inset graphics include) include maintenance of (1) military assets, (2) energy production facilities like wind turbines, and (3) commercial aircraft. AWS is the winner of a 2014 R&D 100 Award. More about the technology can be found on page 18 of this report.



Disclaimer

The Los Alamos National Laboratory strongly supports academic freedom and a researcher's right to publish; therefore, the Laboratory as an institution does not endorse the viewpoint of a publication or guarantee its technical correctness. With respect to documents available from this server, neither the United States Government nor the Los Alamos National Security, LLC., nor any of their employees, makes any warranty, express or implied, including the warranties of merchantability and fitness for a particular purpose, or assumes any legal liability or responsibility for the accuracy, completeness, or usefulness of any information, apparatus, product, or process disclosed, or represents that its use would not infringe privately owned rights. Reference herein to any specific commercial products, process, or service by trade name, trademark, manufacturer, or otherwise, does not necessarily constitute or imply its endorsement, recommendation, or favoring by the United States Government or the Los Alamos National Security, LLC. The views and opinions of authors expressed herein do not necessarily state or reflect those of the United States Government or the Los Alamos National Security, LLC., and shall not be used for advertising or product endorsement purposes. Unless otherwise indicated, this information has been authored by an employee or employees of the Los Alamos National Security, LLC. (LANS), operator of the Los Alamos National Laboratory under Contract No. DE-AC52-06NA25396 with the U.S. Department of Energy. The U.S. Government has rights to use, reproduce, and distribute this information. The public may copy and use this information without charge, provided that this Notice and any statement of authorship are reproduced on all copies. Neither the Government nor LANS makes any warranty, express or implied, or assumes any liability or responsibility for the use of this information.

Issued March 2015
LA-UR-15-21930

Structure of this Report

In accordance with U.S. Department of Energy Order (DOE) 413.2B, the Laboratory Directed Research and Development (LDRD) annual report for fiscal year 2014 (FY14) provides summaries of each LDRD-funded project for the fiscal year, as well as full final reports on completed projects. The report is organized as follows:

Overview: An introduction to the LDRD Program at Los Alamos National Laboratory (LANL), the program's structure and strategic value, the LDRD portfolio management process, and highlights of outstanding accomplishments by LDRD researchers.

Project Summaries: The project summaries are organized first by science and technology categories: Physics, Chemistry and Material Sciences, Environmental and Biological Sciences, Information Science and Technology, and Technology. Within each category, summaries are organized by LDRD component in the following order: Directed Research (DR), Exploratory Research (ER), Early Career Research (ECR), and Postdoctoral Research and Development (PRD). Full final reports are included at the end of each section.

Projects are listed in numerical order according to their project identification number, which consists of three parts. The first is the fiscal year in which the project began; the second is a unique numerical identifier; and the third identifies the project component.

Acknowledgements

Technical Review

William Priedhorsky
Jeanne Robinson

Publication Editor and Designer

Andrea Maestas

Team Contributors

Lennett Rendon
Stephen Schultz
Lisa Lujan
Susan Whittington
Debbie Martinez
Peter Haase

Table of Contents

- 14 **Overview**
- 26 **Complex Natural and Engineered Systems**
- 27 **Using Microreactors for Efficient Plutonium Separations (U)**
Stephen L. Yarbro
- 29 **Maximizing Flux Through Engineered Metabolic Pathways**
Clifford J. Unkefer
- 33 **Discovery Science of Hydraulic Fracturing: Innovative Working Fluids and Their Interactions with Rocks, Fractures, and High Value Hydrocarbons**
Hari S. Viswanathan
- 36 **Combating Antibiotic Resistance: Targeting Efflux Pump Systems at Multiple Scales**
Sandrasegaram Gnanakaran
- 39 **Quantitative Biology: From Molecules to Cellular Function**
Robert E. Ecke
- 42 **Dynamic Earthquake Triggering, Granular Physics and Earthquake Forecasting: Determining the Physical Controls**
Paul A. Johnson
- 46 **IMPACT: Integrated Modeling of Perturbations in Atmospheres for Conjunction Tracking - A New Orbital Dynamics and Drag Model to Avoid Collisions in Space**
Alexei V. Klimenko
- 54 **Predicting Climate Impacts and Feedbacks in the Terrestrial Arctic**
Scott Painter
- 59 **Elucidating Humankind's Evolving Environment: From the Earth's Core to the Cosmos**
Harald O. Dogliani
- 68 **Space Hazards Induced near Earth by Large, Dynamic Storms (SHIELDS): Understanding, Modeling, and Predicting**
Vania K. Jordanova
- 71 **The World's First Drought and Insect Caused Global Tree Mortality Monitoring System**
Chonggang Xu
- 73 **From Troposphere to Ionosphere: How Much do Thunderstorms Disturb the Total Electron Distribution?**
Erin H. Lay
- 75 **Understanding The Catalytic Conversion of Oligosaccharides to Fuels and Chemical Feedstocks**
Andrew Sutton
- 76 **Deciphering Nature's Chemical Toolbox: Decoding the Logic of Biosynthetic Assembly Lines**
Alexander Koglin
- 79 **Identifying, Creating, and Controlling Functional Hotspots in DNA**
Boian Alexandrov
- 83 **Understanding Energetic Ion Transport and Loss in Natural and Artificial Radiation Belts at Low Altitudes**
Misa Cowee
- 87 **Construction and Functionalization of Novel Biomimetic Human Liver**
Jun Gao
- 90 **Label-Free Measurement of Single Cells by Impedance Cytometry in a Microfluidic Device**
Babetta L. Marrone
- 93 **A New Hypothesis to Explain the Variability of the Outer Radiation Belt: Can we Predict Post-storm Fluxes of Energetic Electrons Based only on Pre-storm Fluxes of the Lower-energy Population?**
Gregory S. Cunningham
- 95 **Multidisciplinary Studies of Long Non-coding RNAs: towards a Structural Basis for RNA in Epigenetics**
Karissa Y. Sanbonmatsu
- 97 **How Trees Die: Multi-scale Studies of Carbon Starvation and Hydraulic Failure During Drought**
Sanna A. Sevanto
- 99 **Pyrocumulus Collapse: Unpredicted Wildfire Dangers**
Rodman R. Linn
- 102 **Biocatalysts for Remediation of Uranium Wastes**
Francisca Rein Rocha

-
- 105 Structure Determination of Large and Membrane-Bound Proteins by Nuclear Magnetic Resonance (NMR) Spectroscopy**
Ryszard Michalczyk
- 108 Redox Active Catalysts for C-C Coupling Reactions Relevant to Renewable Energy**
John C. Gordon
- 110 Novel Chemical Architectures for Supercapacitor Electrolytes: Comparing In Situ Scattering Measurements to Theory and Simulation**
Cynthia F. Welch
- 113 One-step Supercritical Fluid Extraction (SFE) and Separation of Rare Earths (RE)**
Stephen L. Yarbro
- 115 Deciphering the Algal Phycosphere**
Armand E. Dichosa
- 117 Intrinsically Disordered Proteins: New Tools for Old Controversies**
James H. Werner
- 119 Electromagnetic Field Control of Cold Molecular Collisions**
Brian K. Kendrick
- 121 Multi-scale Probabilistic Resuspension Modeling of Spores and Radionuclides from Outdoor Surfaces**
Michael J. Brown
- 124 First Direct Observation of Weibel Instability in Collisionless Shocks**
Sasikumar Palaniyappan
- 126 New Chemistry Towards High Purity Uranium and Thorium Nitrides**
Jacqueline M. Veauthier
- 128 Discovery and Implication of Negative Ions in the Earth's Magnetosphere**
Herbert O. Funsten
- 130 Viral Disarmament: A Trojan Protein Approach**
Murray A. Wolinsky
- 132 Understanding Earth's Deep Water Cycle: Neutron Diffraction and Calorimetric Studies of Hydrated Minerals**
Hongwu Xu
- 138 Foundational Methods and Experiments in Ultracold Molecular Physics**
Michael D. Di Rosa
- 143 Multiscale Spacecraft Charging Simulations in Support of New Space Missions**
Gian L. Delzanno
- 148 From Waste to Fuels and Feedstocks: Reduction of CO₂ Using Main-Group Catalysts**
Andrew Sutton
- 154 Laboratory Study of Cosmically-Relevant Collisionless Shocks**
Scott C. Hsu
- 157 Separation of Time Scales at High Latitudes: Fundamental Science and Numerical Method Development**
Robert E. Ecke
- 160 A Novel Mo-99 Separation Process Designed for Next Generation Medical Isotope Production**
Iain May
- 165 Biofuel Enzymes by Design**
William M. Challacombe
- 167 High-Energy Segregated Fuel-Oxidizer Solid Rocket Propulsion System**
Bryce C. Tappan
- 172 Co-Evolution of Protoplanets and Transitional Protoplanetary Disks - Pathway to Giant Exoplanet Formation**
Hui Li
- 177 Metabolic Engineering of an Algal Lipid Bioswitch**
Chris M. Yeager
- 182 A New Class of Antibody-like Molecules that Signal Upon Binding**
Geoffrey S. Waldo
- 186 Energy Efficient, Inducible Harvesting of Microalgae for Biofuels Production**
Richard T. Sayre
- 190 Integrated Biosurveillance**
Benjamin H. McMahon
- 195 Catalysts Containing Earth Abundant Metals for Energy Applications**
John C. Gordon
- 197 Determining Physiological Predictors of Climate-driven Forest Mortality**
Nathan G. McDowell
- 199 Nanoscopic Recrystallization Dynamics and Phase Behavior in Liquid Crystals and Polymers**
Juan Duque

-
- 202 The Fate of the Three Dimensional Electron Far beyond the Quantum Limit**
Ross D. Mcdonald
- 204 The Role of Microscopic Eye Movements in Visual Perception**
John S. George
- 207 Access to Industrially Important Chemical Compounds by Direct Hydrogenation of Biomass Derived Molecules Containing Carbonyl Fragments**
John C. Gordon
- 208 Chemically Modifying the Uranyl Ion**
Jaqueline L. Kiplinger
- 210 Catalytic Mechanism and Inhibition of Metallo-beta-lactamases (MBL): The Ultimate Threat Against Antibiotics**
- 213 Stimuli Responsive, Functional Biopolymers: Quinic Acid-Based Polymers and Their Assemblies**
Hsing-Lin Wang
- 215 Single Cell Genomics for Better Control of Plant Pathogens**
Shunsheng Han
- 217 Exploring Doubly Parasitic Radioisotope Production Via Secondary Neutron Fluence From the 100 MeV IPF Irradiations**
Eva R. Birnbaum
- 220 Hybrid Nanostructures for Photoreduction of CO₂ to Hydrocarbons**
Hongwu Xu
- 222 Joint Inversions of Seismic and Gravity Data in Volcanic Areas to Advance Hazards Assessment: A Focus on the Alaskan Subduction Zone and Kilauea, Hawaii**
Monica Maceira
- 225 Ultrafast Vacuum Ultraviolet Spectroscopy of Complex Materials**
Dmitry A. Yarotski
- 228 Discovery of Novel Bioactive Natural Products**
Alexander Koglin
- 231 From Food to Fuel: Making Ammonia Synthesis Viable for Energy Storage Applications**
James M. Boncella
- 235 Tracking Microbial Activity to Predict the Impacts of Climate Change on Ecosystem Function**
Cheryl R. Kuske
- 237 Complexes Containing Redox-active Ligands for the Synthesis of Fuels from Readily-Available Carbon Sources**
John C. Gordon
- 239 Bottom-up Chemical Synthesis of Large, Well-Defined, and Organo-Processable Nanographene-based Triarylamine for Optoelectronic Applications**
Hsing-Lin Wang
- 241 Mesoscopic Lattice Boltzmann Modeling and Investigation of Boiling Multiphase Flows**
Qinjun Kang
- 243 Access to Industrially Important Optically Active beta-X-alcohols via Direct Enantioselective Ester Hydrogenation**
John C. Gordon
- 245 Synthesis and X-ray Spectroscopy of Actinide Thiocyanates**
Stosh A. Kozimor
- 246 Information Science and Technology**
- 247 Disruptive Innovation in Numerical Hydrodynamics**
Jacob I. Waltz
- 250 Empowering the Expert: Machine Learning with User Intelligence**
Reid B. Porter
- 254 Information-Driven Materials Discovery and Design**
Turab Lookman
- 257 Next Generation Quantum Molecular Dynamics**
Anders M. Niklasson; Robert E. Ecke
- 263 Optimization Principles for Co-Design Applied to Molecular Dynamics**
Stephan J. Eidenbenz
- 267 CoCoMANS: Computational Co-design for Multi-scale Applications in the Natural Sciences**
Dana A. Knoll
- 270 Hierarchical Sparse Models for Robust Analysis of Video Data**
Steven P. Brumby
- 274 Enabling Data-aware Distributed Scientific Computing**
Tanmoy Bhattacharya

-
- 281** **Deterministically Enhanced Monte Carlo for Radiative Transfer**
Allan B. Wollaber
- 313** **Uncertainty Quantification for Networks**
Earl C. Lawrence
- 315** **Non-Equilibrium Fluctuation-Induced Interactions**
Diego A. Dalvit
- 319** **Monte Carlo for Quantum Transport**
James E. Gubernatis
- 325** **Phylogenetic Classification and Analysis of Computer Malware**
Guanhua Yan
- 328** **Combinatorial Approaches To Graphical Models: Theory and Applications**
Michael Chertkov
- 331** **Physics-Based Data Models and Architecture-Optimized Backends for a Portable Data-Parallel Computation Library**
Christopher M. Sewell
- 334** **Co-Design of Burst Buffer Hardware and Data Analysis/Visualization Software for Large-Scale Simulations**
Jonathan L. Woodring
- 336** **Validating Near-Ideal Data Throughput Using a Rate-Compatible Protocol**
Scott H. Robinson
- 346** **Shortcuts to Adiabaticity in Quantum Devices**
Wojciech H. Zurek
- 349** **Cyber Security of the Smart Grid**
Russell W. Bent
- 354** **Edge Traffic Monitoring in Computer Networks**
Curtis B. Storlie
- 359** **Extending the Time-Scale of Protein Simulations using Accelerated Molecular Dynamics Techniques**
Arthur F. Voter
- 363** **Materials for the Future**
- 364** **Empowering the Expert: Machine Learning with User Intelligence**
Reid B. Porter
- 368** **Fighting Carbon with Carbon: All-Carbon Nanomaterial Photovoltaics**
Stephen K. Doorn
- 372** **Design Principles for Materials with Magnetic Functionality**
Joe D. Thompson
- 374** **Non-Precious Metal Electrocatalysts for Clean Energy**
Piotr Zelenay
- 378** **Phase Stability of Multi-Component Nanocomposites under Irradiation; 381 Quantum Chemistry, Information, Materials and Metrology**
Robert E. Ecke
- 386** **Non-Equilibrium Phenomena in Materials, Fluids, and Climate**
Robert E. Ecke
- 390** **Photoactive Energetic Materials for Quantum Optical Initiation**
Robert J. Scharff
- 392** **Multiferroic Response Engineering in Mesoscale Oxide Structures**
Quanxi Jia
- 395** **Exploring Mechanisms of Catalysis on Plutonium Surfaces (U)**
Marianne P. Wilkerson
- 398** **Mesoscale Materials Science of Ductile Damage in 4 Dimensions: Towards the Computational Design of Damage-Tolerant Materials**
Ricardo A. Lebensohn
- 401** **Optimization and Control of Dynamic Networks**
Robert E. Ecke
- 403** **Energy Storage**
Rangachary Mukundan
- 408** **Organic Electronic Materials: Designing and Creating Functional Interfaces**
Sergei Tretiak
- 415** **Plutonium-242: A National Resource for the Fundamental Understanding of 5f Electrons**
Eric D. Bauer
- 419** **Genetically Encoded Materials: Libraries of Stimuli-responsive Polymers**
Jennifer Martinez
- 424** **Modern Challenges in Actinide Science**
Albert Migliori
- 432** **Accelerating Materials Certification through Co-Design**
Jack S. Shlachter

-
- 436 **Meso-Photonic Materials**
Houtong Chen
- 438 **Room Temperature Oxidation and Corrosion of Plutonium**
Alison L. Pugmire
- 441 **Novel Mesoscale Modeling Approach for Investigating Energetically Driven Nanoscale Defect/Interface Interactions**
Abigail Hunter
- 444 **Magnetic Field Effects on Convection-Modified Solid-Liquid Interfaces**
Amy J. Clarke
- 446 **Effects of Joining Processes on Bimetal Interface Content and Radiation Damage Resistance**
John S. Carpenter
- 449 **Probing Interface Reactions of Calcite Nanocrystals at Elevated Temperatures and Pressures**
Rex P. Hjelm Jr
- 451 **Attosecond Dynamics of Correlated Electrons in f-Electron Materials**
Steve M. Gilbertson
- 453 **Investigating the Itinerant to Localized Crossover of the 5f Electrons in Plutonium Alloys and Compounds**
Paul H. Tobash
- 458 **3-Dimensional Characterization of Nuclear Fuels: Microstructural Evolution under Representative Temperature and Thermal Gradients**
Donald W. Brown
- 460 **Very Low Temperature Scanning Point Contact Spectroscopy Investigation of Inhomogeneous States on the Nano-scale**
Roman Movshovich
- 463 **Excited State Quantum Interactions in Carbon Nanotubes**
Stephen K. Doorn
- 466 **Enhancing Thermoelectric Properties of Topological Insulators through Nanostructuring**
Nikolai Sinitsyn
- 468 **“Upscaling” Nanoscale Thermoelectrics: The Meso-macroscale Design Challenge for Real-World Energy Needs**
Jennifer A. Hollingsworth
- 471 **Giving Cold Atoms Weight: Creating Heavy Fermions in Optical Lattices**
Cristian D. Batista
- 473 **Topology in Superposition: Quantum Decoherence in Many-body Systems**
Wojciech H. Zurek
- 475 **Accurate Interfacial Structures for Atomistic Simulations: Minimizing the Grand-Canonical Free Energy**
Danny Perez
- 478 **Understanding and Controlling Magneto-Electric Coupling in Multiferroic Materials**
Dmitry A. Yarotski
- 481 **Spin-state Transitions as a Route to Multifunctionality**
Cristian D. Batista
- 484 **Beyond the Chemical Reaction Zone: Detonation Product Gases in the Warm Dense Regime**
Dana M. Dattelbaum
- 486 **Topological Kondo Insulators**
Joe D. Thompson
- 488 **Semiclassical Modeling of Non-adiabatic Processes in Molecular Materials**
Dima V. Mozyrsky
- 490 **Making nano-Mg a Reality**
Irene J. Beyerlein
- 493 **Toward Tunable Functionalities Using Epitaxial Nanoscaffolding Films**
Quanxi Jia
- 495 **Developing Potentials for Atomistic Modeling of Defect Phenomena at Metal-Ceramic Interfaces**
Steven M. Valone
- 500 **First Principles Many-Body Approaches to Strongly Correlated Actinide Metals**
Jianxin Zhu
- 504 **Are Nanoscale Foams Radiations Resistant?**
Jose A. Caro
- 508 **Ultrafast Spectro-microscopy for Nanoscale Magnetic Domain Imaging**
Richard L. Sandberg
- 511 **Unlocking Plasmons in Graphene**
Kirill A. Velizhanin

-
- 515 **Plasmon-Exciton Interactions in Single-Wall Carbon Nanotube – Metal Nanostructure Complexes**
Han Htoon
- 522 **Nonequilibrium Spin Noise in Semiconductors: Physics and Applications**
Nikolai Sinitsyn
- 525 **Novel Inverted Nanoshells for Multimodal Diagnostic Imaging and Cancer Therapy**
Jennifer A. Hollingsworth
- 531 **Flipping the (light) Switch on Nano-magnetism: Emergent Photomagnetization in Quantum-confined Semiconductors**
Scott A. Crooker
- 534 **Exploiting Metal/Organic Interfaces as Potential Bulk Heterojunctions: Unlocking the Efficiency of Organic Photovoltaics**
Hsing-Lin Wang
- 538 **High Performance Thin Film Super Capacitors**
Aditya Mohite
- 540 **Frustrated Materials**
Cristian D. Batista
- 543 **Designing and Probing Novel Materials by Pressure Tuning of Nanocrystals**
Hongwu Xu
- 546 **NMR Study of Quantum States of Matter**
Joe D. Thompson
- 548 **Electronic and Photonic Transport in Chiral Materials and Nanostructures**
Diego A. Dalvit
- 550 **Efficient Carbon Nanotube Growth on Graphene-Metal Surfaces**
Stephen K. Doorn
- 553 **Alternating Positive-Negative Charge Systems: New Compounds and Synthetic Routes**
David E. Chavez
- 555 **Graphene Quantum Dots for Carrier-Multiplication-Enhanced Solar Cells**
Victor I. Klimov
- 557 **Microstructured Biohybrid Synthesis of Photosynthetic Assemblies**
Gabriel A. Montano
- 560 **Topological Kondo Insulators**
Joe D. Thompson
- 562 **Probing and Modifying Intertube Interactions in Semiconducting Carbon Nanotubes**
Stephen K. Doorn
- 564 **Understanding and Controlling Magnetism in Multiferroics with THz Pulses**
Rohit P. Prasankumar
- 566 **Broken Symmetries in Superconductors**
Albert Migliori
- 568 **Hybrid Metal-Semiconductor Nanostructures for Optimized Photosynthetic Algal Growth**
Jennifer A. Hollingsworth
- 570 **Ultrafast Measurements of Emergent Magnetism in New Complex Oxide Materials**
Scott A. Crooker
- 572 **Design Principles for High Performance Organic Photovoltaics**
Aditya Mohite
- 574 **Synthesis of Novel Energetic Materials**
David E. Chavez
- 575 **Investigating Structure-Directing Agents in Nonconventional Nanowire Synthesis Using a Transmission-Electron-Microscope Flow-Cell Holder**
Jennifer A. Hollingsworth
- 577 **Photoactive Energetic Materials for Quantum Optical Control**
Sergei Tretiak
- 579 **Ultrafast Carrier Dynamics in Novel Two-Dimensional Nanomaterials**
Victor I. Klimov
- 581 **New Room Temperature Multiferroic Thin Films Enabled by Strain Engineering**
Quanxi Jia
- 582 **Rational Design of Multiferroics and Influence of Cationic Disorder on Multiferroicity in Perovskites**
Blas P. Uberuaga
- 584 **Shock-Driven Material Dynamics Investigated by Ultrafast X-ray Diffraction**
Cynthia A. Bolme
- 585 **Quantum simulations: From superconductivity to nanoscale electronics**
Eddy M. Timmermans
- 589 **Multiferroic Magnetoelectric Hybrid Inorganic-Organic Frameworks**
Michael R. Fitzsimmons

-
- 592 **Probing the Structure of Superconducting States with Rotating Magnetic Fields**
Roman Movshovich
- 595 **Direct Tracking of Charge Carriers in Heterostructured Nanowires**
Rohit P. Prasankumar
- 599 **Investigation of the Electronic Structure of Heavy Fermions using ARPES and Tr-ARPES**
Tomasz Durakiewicz
- 601 **Fabrication of an All-Carbon Solar Cell**
Andrew M. Dattelbaum
- 603 **Non-equilibrium Transport in Nanoscale Thermal Energy Harvesting**
Jianxin Zhu
- 606 **High Efficiency Upconversion of Infrared Radiation in Semiconductor-metal Nanostructures for Applications in Solar Energy**
Victor I. Klimov
- 610 **Minority Carrier Devices Based on Concentric Nanowires: Theory and Experiment**
Quanxi Jia
- 615 **Functional Soft Materials by Assembling Metallo-Biopolymers**
Reginaldo C. Rocha
- 619 **Tuned Optical Properties of Low-Dimensional Carbon Nanomaterials for Energy Harvesting**
Stephen K. Doorn
- 621 **Enhanced Structural Robustness in Metal/Nonmetal Nanocomposites using Bio-inspired Structure Design**
Nathan A. Mara
- 627 **Photoactive Energetic Materials for Quantum Optical Control**
Sergei Tretiak
- 628 **Poly-Triphenylamine-Functionalized Graphene Quantum Dots for Flexible High-Performance Polymeric Memory Devices**
Hsing-Lin Wang
- 630 **Nuclear and Particle Futures**
- 631 **Illuminating the Origin of the Nucleon Spin**
Ivan M. Vitev
- 635 **Peta-scale Studies of Cosmic Explosions and Supernova Shock Breakout with Palomar Transient Factory**
Przemyslaw R. Wozniak
- 639 **Probing New Sources of Time-Reversal Violation with Neutron EDM**
Takeyasu Ito
- 642 **First Direct Measurement of High-Z/Low-Z Plasma Interface Evolution in Isochorically Heated Dense Plasma (U)**
Brian J. Albright
- 645 **The Role of Short-lived Actinide Isomers in High Fluence Environments (U)**
Marian Jandel
- 648 **Research Enabling a Next Generation Neutron Lifetime Measurement**
Susan J. Seestrom
- 650 **TeV Jets: Nature's Particle Accelerators**
Brenda L. Dingus
- 655 **Hydrodynamical Mix Studies at the National Ignition Facility (U)**
Michael J. Steinkamp
- 668 **Advancing the Fundamental Understanding of Fission (U)**
Morgan C. White
- 673 **Physics Beyond the Standard Model with the Long-Baseline Neutrino Experiment**
Christopher M. Auger
- 679 **k_{effective}: First Measurement of Nanosecond-Pulsed Nuclear Reactivity on a Subcritical Assembly (U)**
Anemarie Deyoung
- 689 **Gating and Emission Enhancement of Diamond Field-Emitter Arrays**
Heather L. Andrews
- 693 **Enabling Temporal and Spatial Shaping of Ultra-Intense Laser Pulses for Next-Generation, Compact Particle and Radiation Sources**
Rahul C. Shah
- 698 **Large-Scale Simulations for Nuclei and Strongly-Correlated Matter**
Stefano Gandolfi
- 702 **Precision Predictions for Jet Cross Sections**
Christopher Lee

-
- 709 **Ultra-Bright Electron Beam Acceleration in Dielectric Wake Accelerators**
Evgenya I. Simakov
- 712 **Coherent Diffractive Imaging of Ultrafast Ejecta Processes**
Cynthia A. Bolme
- 714 **In Search of Light WIMPs**
Alexander Friedland
- 716 **Emittance-Reduction System for Future Accelerator Solutions**
Kip A. Bishofberger
- 718 **Hybrid Shock Ignition as an Alternate Concept for Fusion Energy**
Eric N. Loomis
- 720 **Quantum Kinetics of Neutrinos in the Early Universe and Supernovae**
Vincenzo Cirigliano
- 722 **Designing the Next Generation Compton Light Source**
Nikolai Yampolsky
- 724 **Combined Klystron and Linac (Klynac)**
Bruce E. Carlsten
- 726 **Multi-GeV Electron Radiography**
Frank E. Merrill
- 728 **Photocathodes in Extremes: Understanding and Mitigating High Gradient Effects on Semiconductor Cathodes in X-FELs**
Nathan A. Moody
- 731 **Petascale Kinetic Plasma Simulation of the Interaction Among Laser Speckles in Nonlinear Optical Systems**
Lin Yin
- 735 **Laser-Driven Relativistic Mechanics, Radiation, and Ion Acceleration**
James A. Cobble
- 739 **Probing BSM Discoveries at the Large Hadron Collider**
Michael L. Graesser
- 743 **A Novel Exploration of Nature's Largest Explosions**
W T. Vestrand
- 748 **Transport by Thermodynamic Cross-terms in ICF Capsule Plasmas**
Xianzhu Tang
- 752 **Graphene Shield Enhanced Photocathodes**
Nathan A. Moody; Scott C. Hsu; Ivan M. Vitev; Christopher Lee; Xiaodong Jiang; Christopher Lee; Vincenzo Cirigliano; Przemyslaw R. Wozniak
- 774 **CP Violation in Scenarios Beyond the Standard Model**
Vincenzo Cirigliano
- 776 **Influence of Velocity Shear on Turbulent Magnetic Reconnection at the Earth's Magnetopause**
William S. Daughton
- 779 **Atomic Coherence with X-Ray Free-Electron Lasers**
Bruce E. Carlsten
- 783 **Precision Fission Cross Section Measurements with a Time Projection Chamber (TPC)**
Fredrik Tovesson
- 787 **The Assembly of Primeval Galaxies and the Birth of the First Quasars**
Hui Li
- 789 **Searching for Sterile Neutrinos with MicroBooNE**
Richard G. Van De Water
- 793 **Using Jet Production to Investigate quark-Gluon Plasma at RHIC**
Xiaodong Jiang
- 795 **The Intersection of the Energy, the Intensity, and the Cosmic Frontiers in the Era of the Large Hadron Collider and XENON Experiments**
Michael L. Graesser
- 797 **Science of Signatures**
- 798 **High Performance Atom-Based Sensors for Fields and Rotations**
Malcolm G. Boshier
- 801 **Battlefield MRI**
Michelle A. Espy
- 803 **Optical and Laser Spectroscopy of Th-229 Electronic and Nuclear Transitions for the Development of Solid State Nuclear Quantum Sensors**
Xinxin Zhao
- 806 **Remote Raman-LIBS Spectroscopy (RLS) Signature Integration**
Samuel M. Clegg

-
- 808 Explosives Signatures for Detection: Nonlinear GHz to THz Responses**
David S. Moore
- 810 F-Element Nitrides: New Synthetic Methodologies and Signatures for the Preparation of Advanced Nuclear Materials (U)**
Jacqueline M. Veauthier
- 813 Laser-Driven Neutron Source for Detection of Nuclear Material**
Andrea Favalli
- 815 Deployment and Installation Technologies for Distributed Measurement Systems in Inconvenient/Hazardous Environments**
David D. Mascarenas
- 817 Next Generation Earth Models**
Monica Maceira
- 819 Wide Field-of-View Plasma Spectrometer**
Ruth M. Skoug
- 822 Phase Transitions at Extremes: Emergence of Topological Defects**
Vivien Zapf
- 825 Magnetic Nanomarker Detection and Imaging with SQUIDs**
Andrei N. Matlashov
- 827 Electron Capture Spectroscopy for Neutrino Mass: Isotopes, Science, and Technology Development**
Michael W. Rabin
- 829 Micro-Mirror Full-Frame Programmable Spectral Filters for the Long-wave Infrared**
Steven P. Love
- 831 Time Resolved Phonon Spectroscopy for Cryogenic Bolometer Readout**
Steven R. Elliott
- 833 Measuring Winds in the Stratosphere using Passive Acoustic Sensors**
Stephen J. Arrowsmith
- 835 Cryogenic Laser Refrigerator for Infrared Imaging**
Markus P. Hehlen
- 838 Matter Wave Circuits**
Changhyun Ryu
- 840 Chemical Shift Signatures of Nuclear Material: ²³⁵U and ²³⁹Pu NMR Spectroscopy**
Michael T. Janicke
- 843 Solid-State Gamma-Ray Detectors Based on Quantum Dots**
Jeffrey M. Pietryga
- 852 A Time Reversal Non Contact Acoustical Source for NEWS (Nonlinear Elastic Wave Spectroscopy)**
Pierre-Yves Le Bas
- 857 Nuclear Quadrupole Resonance: From no Field to Ultra-Low Field**
Michelle A. Espy
- 861 Time-gated Super Resolution Imaging**
James H. Werner
- 866 Lanthanum Bromide Glass Ceramics for Gamma-Ray Spectroscopy**
Markus P. Hehlen
- 871 Measurement of Pressure and Temperature in Thermal Explosions**
Markus P. Hehlen
- 876 Forensic Archaeology of a Manhattan Project Era Nuclear Site**
Warren J. Oldham
- 879 Threat Reduction via Nanomaterials: Engineering a Novel SERS Plat-form for Chemical Detection**
Nathan H. Mack
- 884 Determining Physiological Predictors of Climate-driven Forest Mortality**
Nathan G. Mcdowell
- 886 Catalytic Mechanism and Inhibition of Metallo-beta-lactamases (MBL), the Ultimate Threat Against Antibiotics**
Suzanne Z. Fisher
- 888 Single Cell Genomics for Better Control of Plant Pathogens**
Shunsheng Han
- 890 Joint Inversions of Seismic and Gravity Data in Volcanic Areas to Advance Hazards Assessment: A Focus on the Alaskan Subduction Zone and Kilauea, Hawaii**
Monica Maceira
- 892 Measurement of Orthogonal Velocity Components using Photon Doppler Velocimetry**
Matthew E. Briggs

Laboratory Directed Research & Development: A healthy program under considerable pressure

by William Priedhorsky, Los Alamos LDRD Program Manager



The National Nuclear Security Administration (NNSA) laboratories are responsible for solving some of the toughest technical problems in national security. Maintaining the nuclear weapons stockpile without testing, preventing nuclear smuggling, and addressing environmental remediation—these tasks demand technical expertise from the frontiers in science.

Yet by its very nature, frontier-advancing science is not necessarily applied, and comparatively few frontier-advancing scientists enter national security research directly. Rather, their focus and devotion must be fostered through opportunities for cutting-edge research in the nation's service. Long-term specialization must be complemented with the latest tools, techniques, and talent. In this regard, the Laboratory Directed Research and Development (LDRD) program has proven particularly successful.

Established by Congress in 1991 to maintain the health and technical vitality of the Department of Energy's (DOE's) national laboratories, LDRD currently is the largest single source of capability investment in each of the three NNSA laboratories. Through highly competitive proposal processes, it promotes high-risk, high-reward research designed to advance the frontier of basic science in support of laboratory missions. Indeed, LDRD-funded projects have made seminal contributions to every facet of national security, including stockpile stewardship, high-energy-density matter, high-performance computing and simulation, materials science, chemistry, information systems, biosecurity, cybersecurity, and energy. And many key NNSA programs, as well as R&D scientists and engineers, trace their roots to research that began under LDRD sponsorship.

The January 2014 Omnibus Bill signed by the President of the United States directed all DOE labs to limit their spending on LDRD to no more than 6% of the allowable budget. At Los Alamos, the reduction in LDRD from 8% to 6% represented millions of dollars that had to be pulled back from our brightest researchers working on cutting-edge R&D. A significant portion of the Laboratory's current technical staff was impacted by this reduction, and with LDRD being a critical pipeline for recruitment, a sustained LDRD reduction will undoubtedly impact our workforce for years to come. Some of the performance metrics in this report reflect immediate impacts of a reduced LDRD budget.

Still, LDRD remains a critical investment for Los Alamos. It is a major vehicle for attracting, training, and retaining new technical staff, thus filling the talent pipeline to support the broad generational turnover of national security staff currently underway. And it builds capabilities in nearly every discipline in science, from the prediction and control of materials in extreme conditions, to computing at the exascale, to advances in nuclear and high-energy density physics. By investing in LDRD, Los Alamos takes strides towards its mission to be the National Security Science Laboratory of choice, ready to take on whatever complex issue the nation asks of us.

Laboratory Directed Research and Development is the most prestigious source of research and development funding at the Los Alamos National Laboratory. It follows a strategic guidance derived from the missions of the U.S. Department of Energy, the National Nuclear Security Administration, and the Laboratory. To execute that strategy, the Los Alamos LDRD program creates a free market for ideas that draws upon the bottom-up creativity of the Laboratory's best and brightest researchers. The combination of strategic guidance and free-market competition provides a continual stream of capabilities that position the Laboratory to accomplish its missions.

The LDRD program provides the Laboratory Director with the opportunity to strategically invest in forward-thinking, potentially high-payoff research that strengthens the Laboratory's capabilities for national problems. Funded in FY14 with less than 6% of the Laboratory's overall budget, the LDRD program makes it possible for researchers to pursue cutting-edge research and development. This in turn enables the Laboratory to anticipate, innovate, and deliver world-class science, technology, and engineering.

Program Structure

The Los Alamos LDRD program is organized into four program components with distinct institutional objectives: Directed Research (DR), flagship investments in mission solutions; Exploratory Research (ER), smaller projects that invest in people and skills that underpin key Laboratory capabilities; Early Career Research (ECR), supporting the development of early-career researchers; and Postdoctoral Research and Development (PRD), recruiting bright, qualified, early-career scientists and engineers. In FY14, the LDRD program funded 289 projects with total costs of \$123.7 million. These projects were selected through a rigorous and highly competitive peer review process and are reviewed formally and informally throughout the fiscal year. The LDRD Program Office holds a reserve each year to make modest investments that address new opportunities. In FY14, the reserve budget was approximately \$3.27M.

Directed Research

The DR component makes long-range investments in multidisciplinary scientific projects in key competency or technology-development areas vital to LDRD's long-term ability to execute Laboratory missions. In FY14, LDRD funded 53 DR projects, which represents approximately 54% of the program's research funds. Directed Research projects are typically funded up to a maximum of \$1.8M per year for three years.

Directed Research is organized around Focus Areas that define key areas of science, technology, and engineering in support of Los Alamos missions and that map directly to the four Los Alamos science pillars, plus an additional multi-disciplinary Focus Area that is not captured by the pillars. Between them, they capture the capabilities that are essential to our Laboratory missions in the long term (3-15 years). For each Focus Area, coordinators led a process to engage broadly with the Lab to set investment priorities for the FY14 Strategic Investment Plan, published labwide.

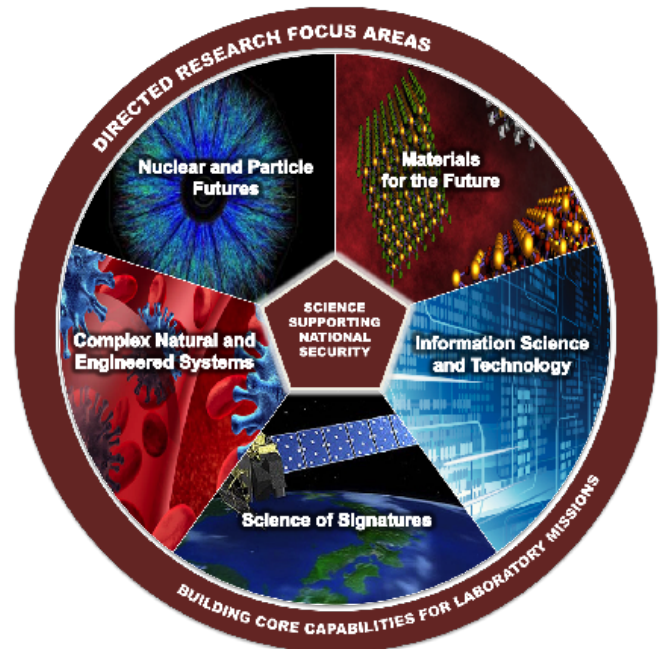

Exploratory Research

The ER component is focused on developing and maintaining technical staff competencies in key strategic disciplines that form the foundation of the Laboratory's readiness for future national missions. Largely focused on a single discipline, ER projects explore highly innovative ideas that underpin Laboratory programs. In FY14, LDRD funded 128 ER projects, which represents approximately 33% of the program's research funds. Exploratory Research projects are typically funded up to a maximum of \$390K per year for three years.

Unlike DR proposals, division endorsements are not required for ER proposals; instead, this component of the LDRD program is operated as an open and competitive path for every staff member to pursue funding for his/her great idea. The ER component is a critical channel for purely bottom-up creativity at the Laboratory. Nonetheless, it is strongly driven by mission needs via the definition of the 12 ER research categories, and the assignment of investment between them.

Directed Research Focus Areas	Mission Impact
Information Science and Technology	Advance theory, algorithms, and high-performance computing to accelerate the integrative and predictive capability of the scientific method.
Materials for the Future	Rapidly meet mission needs based on a thorough knowledge of materials properties and interactions in relation to composition, structure, and scale.
Science of Signatures	Apply science and technology tools to extremely complex problems in signature, identification, and characterization, understanding, control or mitigation.
Nuclear and Particle Futures	Advance the Defense Programs weapons research, the nuclear component of threat reduction, and the pursuit of fundamental physics that underlies our understanding of the universe.
Complex Natural and Engineered Systems	Understand, predict, integrate, design, engineer, and/or control complex systems that significantly impact national security, particularly those involving energy, infrastructure, or societal sustainability.

Exploratory Research Technical Categories	Laboratory Capability
Biological, Biochemical, and Cognitive Sciences	Biosciences
Chemistry and Chemical Sciences	Chemistry
Computational and Numerical Methods	Information and knowledge sciences, computer and computational sciences
Computer Science, Mathematics, and Data Science	High-performance computing, data analysis, and data-driven science
Defects and Interfaces in Materials	Theoretical, computation and modeling, and experimental methods to understand defects and interfaces in materials
Earth and Environmental Sciences and Space Physics	Earth and space sciences
Engineering Applications	Weapons science and engineering, advanced manufacturing, sensors, and remote sensing
Emergent Phenomena in Materials Functionality	Theory, computation and modelling, and experimental methods to understand behavior of materials
High-energy Density, Plasma, and Fluid Physics	High-energy density plasmas and fluids and beams
Measurement Science, Instrumentation, and Diagnostics	Measurement methods that enable new scientific discovery
Nuclear and Particle Physics, Astrophysics, and Cosmology	Nuclear physics, astrophysics, and cosmology
Quantum and Optical Science	Fundamental interactions and excitations in atomic, optical, and molecular systems

Early Career Research

The ECR component of the LDRD program is designed to strengthen the Laboratory’s scientific workforce by providing support to exceptional staff members during their crucial early career years. The intent is to aid in the sometimes challenging transition from postdoc to full-time staff member, and to stimulate research in disciplines supported by the LDRD program. In FY14, the LDRD program funded 27 ECR projects, which represents approximately 3% of the programs research funds. Early Career Research projects are funded up to \$225K per year for two years, and only up to 60% of their overall funding can be from the LDRD program.

Postdoc Research and Development

The PRD component ensures the vitality of the Laboratory by recruiting outstanding researchers. Through this investment, the LDRD program funds postdoctoral fellows to work under the mentorship of PIs on high-quality projects. The primary criterion for selection of LDRD-supported postdocs is the raw scientific and technical talent of the

candidate, with his or her specialty a secondary factor. In FY14, LDRD funded 81 PRD projects, which represents 7% of the program’s research funds. These postdocs are supported full-time for two years.

In addition to approximately 65 Director’s Postdocs, the LDRD program supported 14 distinguished postdoctoral fellows at a higher salary and for a three-year term. Distinguished postdoctoral fellow candidates typically show evidence of solving a major problem or providing a new approach or insight to a major problem and show evidence of having a major impact in their research field. To recognize their role as future science and technology leaders, these appointments are named after some of the greatest leaders of the Laboratory’s past.

More postdocs are hired through DR and ER projects than directly through PRD appointments. Counting both avenues, the LDRD program supported 52% of the 508 postdocs at the Laboratory in FY14.

Impacts of a Reduced LDRD Program on the S&T Pipeline

The national laboratories have a long-standing reputation of being centers of scientific excellence where the nation’s best and brightest researchers can become scientific leaders. For this reason, many young researchers forego the prestige and visibility of academic careers and choose to devote their talents to the national labs, where their innovations benefit national security missions.

One of the early impacts of the FY14 LDRD funding reduction is the decreasing number of postdocs at the Laboratory. At Los Alamos, the postdoctoral program is the Laboratory’s primary tool for recruiting new talent. The data in Figure 1 indicate a drop in the number of postdocs at the Laboratory coinciding with congressional decisions to reduce LDRD in FY14.

These changes in LDRD, which directly impact the S&T pipeline, come at a time when the Laboratory faces aging demographics in its workforce, as shown in Figure 2. By October 2019, approximately 36% of the current R&D population at Los Alamos is projected to leave.

Figure 1

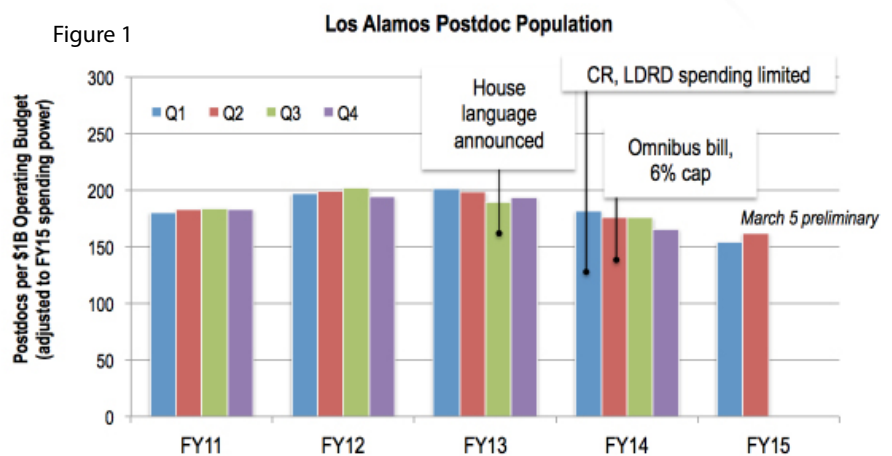
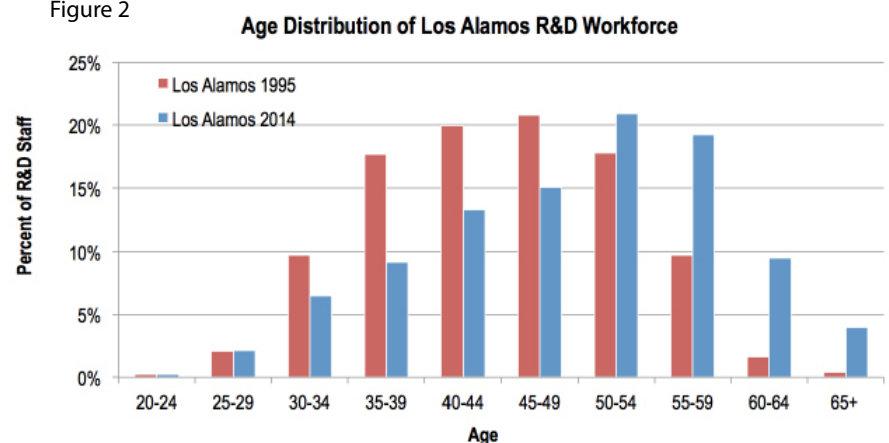

Figure 2



LDRD Helps Attract and Develop Emerging Leaders

With support from LDRD, Los Alamos R&D Engineer Eric Flynn and colleagues developed a technique called Acoustic Wavenumber Spectroscopy (AWS), which generates images of hidden structural properties and/or defects. AWS generates such images by taking fast, full-field measurements of a structure's steady-state response to periodic ultrasonic excitation.

AWS's novelty is in its ability to extract local wave propagation properties by using continuous, periodic ultrasonic excitation and continuous-scan sensing, which enables noninvasive, high-rate and high-resolution ultrasonic imaging. Taking measurements of a structure's relatively high amplitude steady-state response yields significantly faster scans by avoiding many of the wave-reverberation and signal-to-noise-ratio issues associated with typical scanned ultrasonic measurements.



Eric Flynn

R&D Engineer and LDRD Early Career Researcher

Because AWS is more than 30 times faster than the leading noncontact ultrasonic inspection technology, it has the potential to drastically reduce the inspection time of materials, structures, and systems. Without even accounting for the reduction in setup time, the inspection of a ten meter-square area that would take an hour or more to complete will now take as little as two minutes. Traditional contact methods used to perform inspections can only scan an area as large as the machine's scanning mechanism. The reason for such limitation is that the sensor head must physically reach each inspection point.

AWS scans large areas from a fixed instrumentation point and only requires exposure of the part to line of sight, leading to additional savings in effort and time. The reductions in time and effort will reduce costs associated with current inspection schedules and will decrease downtime

of user assets. Moreover, such reductions will enable new, more frequent, and previously economically infeasible inspection schedules and procedures, translating to significant risk reduction as a result of defects being detected earlier and more reliably. Such risk reduction translates into enhanced safety and enables engineers to develop more economical system designs.

Winner of a 2014 R&D 100 Award, AWS has three primary applications:

- **Aerospace** - Specific applications include fleet maintenance, including performing zero-down-time quick checks between flights and automated aircraft full-body scans. AWS is particularly effective and economical when it comes to detecting delamination and disbonding in composite parts.
- **Manufacturing** - Because it is fast and non-contact, AWS is ideal for noninvasive, in-line inspections of all manufactured components— not just samples—for efficient and effective quality control of part dimensions, material properties, coatings, bonds, and welds
- **Commercial Energy** - AWS performs permanent monitoring and on-demand inspection of energy production facilities. Specific applications include the inspection and monitoring of pipelines, pressure vessels, and wind turbines. AWS, with its unique flexibility and speed, also fills the quality control needs of onsite wind turbine blade manufacturing.

The technology will impact the missions of the Department of Energy with measurements of the material levels, distribution, and properties of the contents within containment vessels. AWS supplements existing radiation and weight-measurement technologies designed to perform unattended verification of in-process nuclear materials. The Department of Defense will benefit as AWS can help maintain military air, ground, and naval assets. Maintenance accounts for the majority of the costs associated with the military system lifecycle and significantly reduces asset readiness.

The Los Alamos LDRD program invested in AWS through PRD project led by Eric Flynn, and a recent ECR project. He was recruited to Los Alamos through an LDRD-supported Director's Fellowship and is now a member of the Laboratory's Engineering Institute. He has a leadership role in the Los Alamos Dynamics Summer School and is an emerging leader in the area of Structural Health Monitoring.

Recruit, Retain, Transition: The Path to Mission Impact

While LDRD plays a critical role in recruiting and retaining new technical staff, it is not a source of long-term funding. At Los Alamos, about 70% of LDRD-supported postdoc conversions spend most of their time on non-LDRD programs and contribute to a wide range of missions. A small fraction participate in LDRD projects building capabilities for future programs.

LDRD-supported Postdoc Conversions
% time currently charged to LDRD

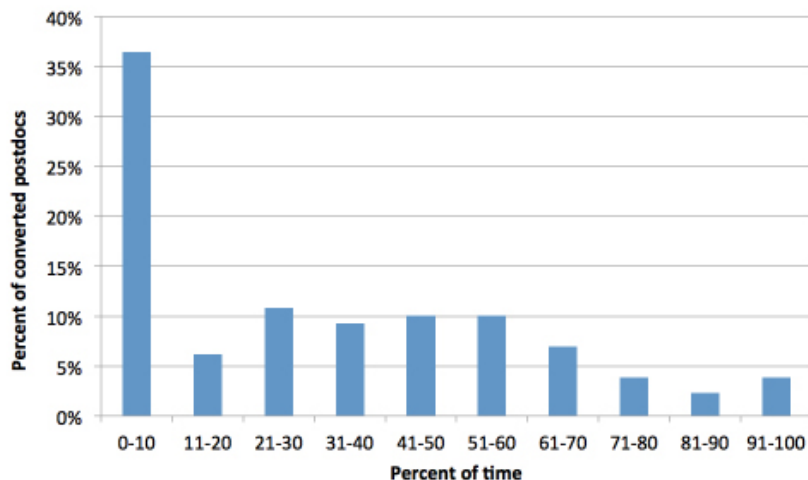

LDRD-supported Postdoc Conversions
Current Contributions to Programs

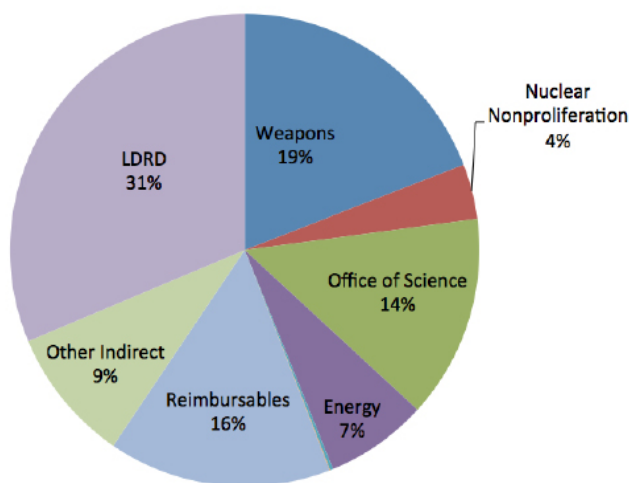

The Gemini subcritical experiment series has significantly impacted the Stockpile Stewardship mission to better understand the physics performance of a nuclear weapon.

All of the early-career contributors to Gemini were recruited to Los Alamos by the LDRD program and then transitioned to programmatic work.

Project Selection

The LDRD program is the vehicle by which the Laboratory harvests the ideas of some of our best and brightest scientists and engineers to execute DOE/NNSA missions. This bottom-up approach is balanced by a program management strategy in which Senior Laboratory leadership sets science and technology priorities, then opens an LDRD competition for ideas across the breadth of the Laboratory. Panels formed from the Laboratory's intellectual leaders rigorously review proposals. Conflict of interest is carefully regulated, and evaluation criteria include innovation and creativity, potential scientific impact, viability of the research approach, qualifications of the team and leadership, and potential impact on Laboratory missions. The selection processes are modeled on best practices established by the National Science Foundation (NSF) and National Institutes of Health (NIH).

To guarantee fairness and transparency, and to ensure that the strongest proposals are funded, the selection panels include managers and technical staff drawn from the full range of technical divisions. Serving on an LDRD selection panel is often a starting point on the path to leadership roles in the scientific community. Past LDRD panelists have gone on to be Laboratory Fellows, division leaders, program directors, association Fellows, and chief scientists, while others have become leaders in academia.

Independent project appraisals

In FY14, the LDRD Program Office conducted an appraisal of every ongoing project it intended to fund in the next fiscal year. The primary objective is to assess progress and provide peer input to help PIs maintain the highest quality of work. The appraisals also help the LDRD Program Office monitor and manage the program portfolio. In addition to formal project appraisals, which are conducted annually, the LDRD Program Director and Deputy Program Director meet informally with PIs in their labs at least once a year to discuss their projects. The purpose of these one-on-one meetings is to give PIs individualized assistance and to determine what the LDRD Program Office can do to positively impact the success of the project. Every DR project has also been assigned a Program Development Mentor to assist the transition of LDRD successes to mission. Any weaknesses are actively addressed, and the project leader is asked to respond to the report with a revised project plan.

Continuing DR projects are appraised every year of the life of the project, with at least one of the reviews including external reviewers. The internal-external review is open to all Laboratory staff and leaders. Four project appraisers – two internal and two external – are nominated by the PI and approved by the LDRD Program Director. When pos-

sible, the appraisal is held as part of a broader workshop hosted by the Laboratory.

Written appraisals, held in the LDRD archives, address: (1) Brief summary of accomplishments; (2) Assessment of quality of science and technology, relevance to Laboratory and national missions, progress toward goals and milestones, project leadership, and the degree to which the project may establish or sustain a position of scientific leadership for the Laboratory; and (3) Recommendations by the committee for changes in the scope or approach of the project. The criteria for the most important point – number (2) above – are derived from criteria developed by the National Academy of Science to assess all federally sponsored research.

Continuing ER and ECR projects are appraised in their first and second years. The LDRD Deputy Program Director collaborates with the technical divisions to conduct project appraisals. Like DRs, the projects are appraised according to the Federal criteria of quality, performance, leadership, and relevance.

LDRD service provides benefit to all

The mission of the Laboratory is to solve the nation's most difficult national security problems. By their nature, these problems lack a well-defined path to solution. In fact, the path is often completely unknown. It is rare that such creative work is done alone; the ideas and results from many colleagues are needed, often drawn out in conferences, hallway conversations, journals, and seminars. LDRD is an internal arena in which Laboratory staff serve as peer reviewers and play a key role of interaction in the scientific process. Proposal selection panelists are chosen for their subject-matter expertise, and the discussions in which they engage are not only critical to the LDRD process, but they also provide an opportunity for panelists to educate themselves on the latest results and practices, and expose themselves to opportunities for collaboration. As noted in an evaluation of peer review conducted by the UK House of Commons, "Peer review is regarded as an integral part of a researcher's professional activity; it helps them become part of the research community."

Project Appraisals Evaluate Progress, Steer Toward Success

The Los Alamos LDRD program assesses the quality, performance, leadership, and relevance of a funded DR project every year until it ends. A “wrap-up” appraisal is then conducted to determine how the project concluded and to explore avenues for program development.

OUTSTANDING (5)

Work leads its technical field; outstanding ratio of results to investment; potential for revolutionary impact on Los Alamos Missions; results of project have spurred follow-on research.

GOOD (3)

Identifiable impact on mission or field; results mixed; success would have a distinct impact on Lab programs; identifiable early signs of external recognition

DEFICIENT (1)

Quality of research does not meet national and Laboratory standards; serious problems with project execution; anticipated minimal impact on Lab mission and science; minimal evidence of external recognition.

EXCELLENT (4)

Clear differentiation from previous work; team is making very good progress; potential for important impact on mission and technical field; follow-ons visible within Laboratory.

FAIR (2)

Largely incremental, marginal impact on mission or field; identifiable lack of progress; notional connections to National Security missions; minimal evidence of external recognition.

Analysis of FY14 DR projects in their second year showed an average score of 4.3, which is between excellent and outstanding. This average reflects 12 appraisals.

Comments and Recommendations From a DR Appraisal

Quality: Excellent - Both the aggregate project and some individual technical tasks have advanced beyond prior capability and results.

Performance: Outstanding - The team has more than 23 articles published or in process; leads emerging areas in technical societies; and reaches out to influential stakeholder groups.

Relevance: Excellent - Capability that is being developed within this project contributed significantly to team members co-authoring successful proposals to the recent DOE lab call for unconventional fossil fuels.

Leadership: Excellent - Task leaders are executing their research plans and effectively communicating results.

We recommend the team develop a new research plan for the remaining 18 months, beginning by redefining their goals and primary objectives, and including a rigorous assessment of research schedules.

The team is encouraged to develop explicit communication and technology transfer plans. They could take their interactions with industry and with researchers from good to great.

Some of the experiments and field-scale model validations would benefit from partnerships. Specifically, the panel recommends that the team determine which microfluidics experiments will be best done at LANL and which should be done at a partner university.

Mission Relevance

Mission relevance is one of the most important criteria in the evaluation of a potential LDRD project; it is carefully considered in project selection and tracked annually through the data sheet process. Many of the technologies that put Los Alamos on the map have deep roots in LDRD and are valuable to DOE/NNSA mission areas of nuclear security, energy security, environmental remediation, and scientific discovery and innovation. LDRD work also benefits the national security missions of the Department of Homeland Security, the Department of Defense, and Other Federal Agencies. As a result, the scientific advances and technology innovations from LDRD provide multiple benefits to all Los Alamos stakeholders, consistent with Congressional intent and the Laboratory’s scientific strategy.

Impacts on the Nuclear Weapons Program

Over the past decade or more, LDRD has filled the void of steadily declining investment in long-term basic research in the Nuclear Weapons program. Los Alamos LDRD projects have improved high explosives, developed new manufacturing methods to reduce the complexity of weapons components, and advanced the actinide science that is at the core of the nuclear weapons complex.

Proton radiography is a powerful example of early LDRD investment that is still paying dividends today. Using penetrating high-energy protons, it lets us look inside weapons components in the midst of an explosion. Its results are essential to decisions with billion-dollar price tags, like the reuse of components from one weapon system to another. Today the U.S. Army is using proton radiography to improve the armor that protects our troops.

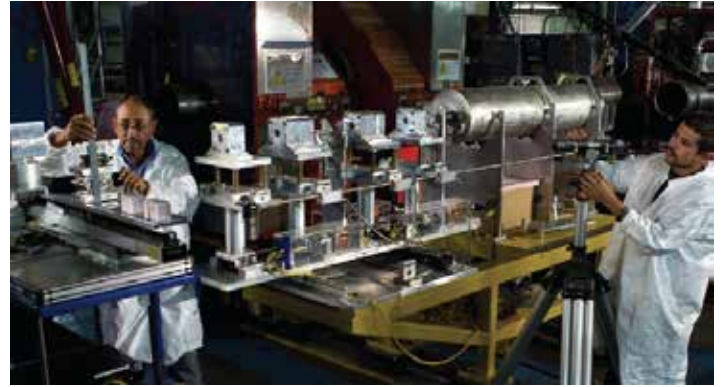

The proton radiography facility at the Los Alamos Neutron Science Center, where a powerful proton beam can take “movie” images of a shock wave traveling through high explosives and other weapons materials.

FY14 LDRD Investment in DOE Missions (\$K)

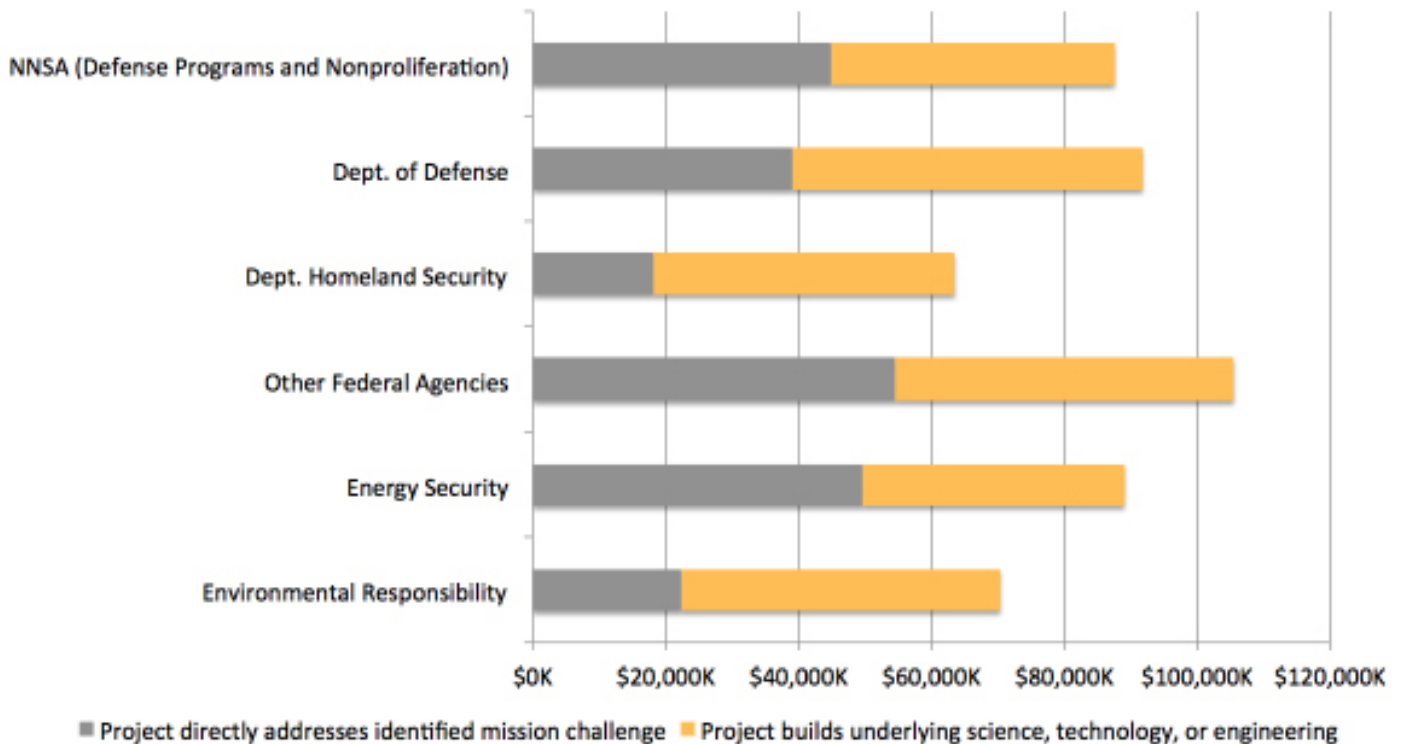

The chart above shows the mission relevance of FY14 LDRD portfolio. The dollar amounts total more than 100 percent of the total FY14 budget because many LDRD projects impact and have relevance to more than one mission area.

Buying Down Risk for Mission

The Los Alamos LDRD program consistently opens up new mission prospects by buying down risk, and the programmatic impacts of its success are numerous. The following are just a few examples.

Supernovae as a Laboratory for Weapons Codes

In the absence of full-scale underground tests, LDRD physicists test weapons simulation codes with supernova observations. Supernovae provide environments of extreme pressure, temperature, and density – similar to what is found in a nuclear explosion. As a result of this innovative work, Los Alamos has improved weapons code validation and verification, yielding improved prediction of stockpile performance. Software developed for supernova observations is now used extensively within the ASC program.



Supernovae offer a unique way to test weapons-related codes

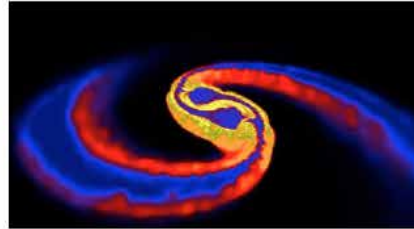

Heavy element opacities tested in models of colliding neutron stars

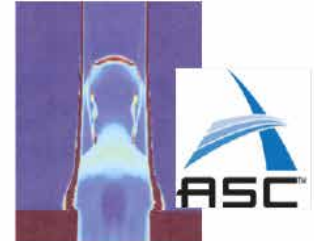

Improved codes are now in use to model science campaign radiation flow experiments

Detecting Nuclear Material in Cargo with Muons

Following the September 11th terrorist attack, LDRD invested in muon tomography to image nuclear threats in cargo. In collaboration with Decision Sciences, the technology was implemented in a detection system currently in use at the Freeport Container Port in the Bahamas.

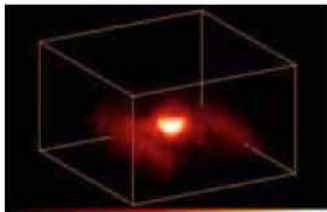

Muon radiography enables precise discrimination of materials

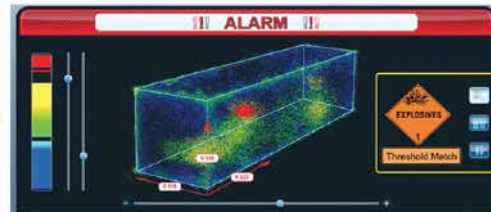

A change in a muon's trajectory means the muon has been scattered by the cargo



Detects nuclear material, and with no radiation hazard

Laser-induced Breakdown Spectroscopy

ChemCam, an instrument onboard the NASA Mars Science Laboratory rover, analyzes rocks from a distance with a Laser-Induced Breakdown Spectrometer (LIBS) developed with LDRD support. Thanks to LIBS, we know that rocks on Mars were formed in the presence of water. Back on Earth, LDRD developed an application of this technology for finding and analyzing nuclear materials.



Determines the composition/concentration of elements using an intense laser beam



LIBS enables the Mars rover to analyze rocks from a distance



Backpack LIBS makes it possible to detect, verify, and study critical materials in the field

Awards and Recognitions

The LDRD program supports some of the Laboratory's most accomplished researchers, as well as many of its most promising young scientists and engineers. In the past year, LDRD researchers received many awards and recognitions, including R&D 100 Awards; fellowships from professional associations; and prestigious Laboratory honors.

Los Alamos National Laboratory Fellows

The Los Alamos National Laboratory Fellows organization was established in 1981 and comprises technical staff members who have been appointed by the Laboratory director to the rank of Fellow in recognition of sustained outstanding contributions and exceptional promise for continued professional achievement. Fellows are limited to 2 percent of the Laboratory's technical staff. They advise management on important issues, promote scientific achievement, and organize symposia and public lectures.



All the 2014 Los Alamos Fellows contribute to LDRD: Christopher L. Fryer, Jaqueline L. Kiplinger, Herbert O. Funsten, John C. Gordon, and David S. Moore

"The sustained scientific excellence demonstrated by the work of Chris, Herb, John, Jaqueline and David exemplifies the outstanding people and capabilities we apply to today's national security mission, and positions the Laboratory to be prepared to meet future challenges," said Laboratory Director Charlie McMillan.

In 2014, the LDRD Program Office was pleased to announce that all the selected Fellows are LDRD contributors, both as leaders of projects and members of various proposal review panels.

When asked how LDRD has helped him accomplish his scientific goals, one of the new Fellows, Herbert Funsten, responded, "Innovative solutions to the most challenging

national security problems of today and tomorrow *require* multidisciplinary capabilities and approaches. LDRD is the only vehicle available at Los Alamos for initiating and sustaining cross-disciplinary, innovative, high risk research that has direct impact on national security programs."

American Physical Society Fellows

Nine Los Alamos National Laboratory scientists were selected Fellows of the American Physical Society (APS), all of whom are either current or past LDRD contributors.



Cristian Batista, Malcolm Boshier, Dana Dattelbaum, Stephen Doorn, Michelle Espy, George Rodriguez, Avadh Saxena, Sergei Tretiak, and Lin Yin, all LDRD contributors, were named APS Fellows.

"Selection as American Physical Society fellows is de facto proof of the vibrant engagement Los Alamos scientists are having with the larger technical community," said McMillan. "I am proud of the contributions Los Alamos scientists bring to these professional societies through papers, scientific conference attendance, and other professional interactions. Collaboration and the exchange of ideas through affiliations within societies such as APS play an important role in fueling the scientific innovation required to accomplish our national-security mission."

The APS is a non-profit membership organization working to advance and diffuse the knowledge of physics through its outstanding research journals, scientific meetings, and education, outreach, advocacy and international activities. APS represents more 50,000 members, including physicists in academia, national laboratories and industry in the United States and throughout the world.

Performance Metrics

The LDRD program is a key resource for addressing the long-term science and technology goals of the Laboratory, as well as for enhancing the scientific capabilities of Laboratory staff. Through careful investment of LDRD funds, the Laboratory builds its reputation, recruits and retains excellent scientists and engineers, and prepares to meet evolving national needs. The impacts of the LDRD program are particularly evident in the number of publications and citations resulting from LDRD-funded research, the number of postdoctoral candidates supported by the program, and the number of awards LDRD researchers received.

Publications

The numerous publications made possible with LDRD funding help the Laboratory maintain a strong presence and scientific reputation in the broader scientific community. In FY14, LDRD researchers generated 475 peer-reviewed publications, accounting for 21% of the Laboratory's total. The quality of these publications is evidenced by the number of times they were cited. LDRD publications published in FY14 were cited 833 times, accounting for 23% of the Laboratory's citations, as well as one of the Laboratory's top 10 cited publications. With increased efforts to collect post-project performance metrics, LDRD publication and citation counts increase year-to-year.

Peer-Reviewed Publications*				
	FY11	FY12	FY13	FY14
LANL Pubs	2079	2119	2082	2215
LDRD Supported	452	458	534	475
% due to LDRD	22%	22%	24%	21%

Citations*				
	FY11	FY12	FY13	FY14
LANL Citations	24880	24230	12695	3677
LDRD Supported	6868	5826	4430	833
% due to LDRD	28%	24%	35%	23%
Top 10 Most Highly Cited Publications				
LDRD Supported	4	3	5	1

*Publication and citation counts are updated annually.

Patents and Disclosures

Another indication of the cutting-edge nature of the research funded by LDRD is the contribution the program makes to the intellectual property of the Laboratory. In FY14, LDRD-supported research resulted in 14 patents, 27% of the Laboratory's total, and 12 disclosures, 17% of the Laboratory's total.

Patents Granted				
	FY11	FY12	FY13	FY14
LANL Patents	59	72	77	51
LDRD Supported	15	11	32	14
% due to LDRD	25%	15%	42%	27%

Disclosures				
	FY11	FY12	FY13	FY14
LANL Disclosures	116	129	103	71
LDRD Supported	16	28	34	12
% due to LDRD	21%	22%	33%	17%

Postdoctoral Support

LDRD remains an important vehicle for recruiting the brightest researchers to the Laboratory, where they become innovators and scientific leaders. In FY14, LDRD supported 266 postdocs, accounting for 52% of the Laboratory's total.

Postdoc Support				
	FY11	FY12	FY13	FY14
LANL Postdocs	580	581	596	508
LDRD Supported	330	349	367	266
% due to LDRD	57%	60%	61%	52%

Postdoc Conversions				
	FY11	FY12	FY13	FY14
LANL Conversions	44	41	57	50
LDRD Supported	17	21	34	26
% due to LDRD	39%	51%	59%	52%



Complex Natural & Engineered Systems

Using Microreactors for Efficient Plutonium Separations (U)

Stephen L. Yarbro
20130003DR

Introduction

Chemical separations, especially difficult separations depend on many factors. Fundamentally, reactions and rates are controlled by mass and heat transfer characteristics of the equipment. In equipment where the length scales are very large with respect to the boundary layers and therefore turbulent eddies are formed, mass and heat transfer are controlled by the contact area and 'mixing' energy per volume. In equipment such as microreactors, where the length scales are small with respect to the boundary layer and the flow is predominantly laminar, heat and mass transfer are controlled by different mechanisms. In this work, we propose to conduct studies with a difficult separation problem with importance to LANL missions and examine the fundamental roles of how heat and mass transfer effect the separation efficiency at these small scales.

Benefit to National Security Missions

The U.S. has an ongoing need for efficient actinide separation methods. Specifically, the will develop our ability to deploy advanced separation methods for weapons materials purification, advanced nuclear systems, nuclear forensics, and environmental management. It will also expand our capabilities in detection, measurement, and analysis of nuclear and radiological materials. In addition, it will provide an ability to conduct small-scale research and development with scarce and unique materials.

Progress

In summary, project accomplishments over the last 12 months:

Develop and model unit-cell design concepts

1. Successfully completed continuum-based fluid dynamics calculations on the Burns-Ramshaw mass transfer experiment and correctly modeled drop formation, flow regime and mass transfer rates

2. Completed Lattice-Boltzmann model of two-phase system with diffusion
3. Successfully completed testing of alternative design concept based on electro-dialysis approach

Fabricate and test integrated contacting device (unit-cell)

1. Successfully fabricated and testing co-current drop formation, flow and separation in single unit-cell with >99.9% phase separation
2. Successfully fabricated serpentine contact cell with an integrated hydrophobic/hydrophilic membrane and initiated testing
3. Completed upgrade of laser fabrication system to allow more precise control which enables fabrication of more complex flow geometries
4. Improved microscopy method for characterizing fluid flow in microreactors

Chemistry

1. Completed first set of equilibrium data measurements with a liquid anion exchanger and plutonium in microchannel system
2. Completed reaction rate measurements for incorporation into mass transfer models
3. Completed first measurements of temperature dependence of equilibrium data in liquid anion exchanger

Future Work

In FY15, the project will continue to further develop design concepts and verify them with multiscale modeling including continuum and Lattice-Boltzmann. Fabrication and testing of the equipment operating conditions will occur in parallel with refinement of the various chemical systems chosen for study. These devices will be tested with actual plutonium solutions and parameters developed for simple mixing, separation and reduction-oxidation methods. In addition, the project will continue testing design and development of on-line process diag-

nostics and testing of the radiolytic effects of radioactive materials on the chemical systems. This work will result in developing the design and initiating the fabrication of a more complex system based on the selected chemical system and scale-up of the preliminary contacting equipment.

The goals are the following:

- Develop, fabricate and model countercurrent/cross-flow contacting module
- Refine conditions for the selected extraction system
- Link simple contact systems to test separation modules
- Design and initiate fabrication of intermediate system
- Test separation module to measure mass transfer and separation factors

Conclusion

The United States has an ongoing need for efficient actinide separation techniques. Our technical goal is to engineer a system based on a new understanding of the mass and heat transfer effects at small length and time scales to build a robust capability to carry out difficult separations. This will result in a processing capability that can meet new programmatic needs in a variety of national security, research, space and non-proliferation programs.

Publications

Chamberlin, R. M., D. L. Decker, D. R. Porterfield, P. Martinez, and S. L. Yarbro. Kinetic factors in liquid-liquid extraction of Pu(IV) from hydrochloric acid solution. 2014. Manuscript in preparation.

Chamberlin, R. M., K. Spencer, and S. L. Yarbro. New solvent systems for a plutonium separation. 2014. Manuscript in preparation.

Chamberlin, R. M., S. L. Yarbro, A. P. Borrego, D. L. Decker, C. C. Finstad, J. Gao, P. Martinez, Q. McCulloch, D. R. Porterfield, J. Rowley, K. R. Weisbrod, and N. Xu. Microfluidic and micro-engineered separations for actinide processing and analysis. Presented at 38th Actinide Separations Conference. (Albuquerque NM, 20-22 May, 2014).

Dervishi, E.. Graphene as a potential membrane material. 2014. Los Alamos National Laboratory unclassified release.

McCulloch, Q.. Fabrication and testing of countercurrent and quasi-countercurrent microfluidic systems. 2014. Los Alamos National Laboratory unclassified release.

Roberts, R. M.. FY 14 Report: Lattice Boltzmann modeling of microreactor systems. 2014. Los Alamos National Laboratory unclassified release.

Weisbrod, K., R. M. Roberts, R. M. Chamberlin, and S. L.

Yarbro. Simulation of mass transfer in a microfluidic experiment using the moving mesh method. 2014. COMSOL User's Conference, September 9, 2014.

Xu, N., A. Castro, J. Gao, B. Manard, L. Meyers, R. M. Chamberlin, and L. Tandon. Chemical separation and measurement tool box for bulk SNM analysis. Presented at DHS-DNDO-NTNFC Annual Review . (Chicago IL, 4-7 August 2014).

Maximizing Flux Through Engineered Metabolic Pathways

Clifford J. Unkefer
20130091DR

Introduction

The long-term goal of synthetic biology is to engineer microorganisms to produce high-value products for biotechnological applications like biofuels production, environmental remediation and biosynthesis of pharmaceuticals. To achieve this goal, it will be necessary to engineer functional multi step metabolic pathways in organisms, which will require a new approach to regulate the expression of each of the enzymes in a metabolic pathway in order to optimize the flux through the pathway. We seek to develop a new paradigm in metabolic pathway engineering by creating a simple approach to optimize the expression of individual enzymes in a pathway, in order to maximize flux through the pathway. Because previous attempts to improve metabolic flux by over-expressing individual enzymes have achieved only limited success, we will simultaneously optimize the expression of each of the enzymes in the pathway. This will be done using the novel strategy of directed evolution of riboregulators using *in vivo* selection. Riboregulators are recently discovered class of RNA molecules that can be used to control the translation of a gene. It is possible to design an ensemble of riboregulators so one can individually control the translation of each of the genes that encode for a metabolic pathway. Riboregulators make pathway optimization possible because: 1) they allow the expression of a particular gene to be tuned over a wide dynamic range; 2) a set of riboregulators can be readily designed to independently regulate the expression of multiple genes; and 3) they are very tractable for directed evolution, because they can be finely tuned by varying only a few nucleotides. Our riboregulators approach to synthetic biology will have wide applicability. We will demonstrate this novel approach by engineering a more carbon- and energy-efficient pathway for lipid biosynthesis in a photosynthetic organism, an essential goal of biofuel research.

Benefit to National Security Missions

Synthetic biology is on the verge of producing practical solutions in a wide variety of application areas (energy, sensing, medicine, materials). This DR will allow LANL to become a major contributor to this rapidly growing field. We will apply our new synthetic biology tool set to solve a key limitation in biofuel production. This project will help sustain LANL leadership in algal bioenergy and contribute directly to LANL's mission in Energy Security. At the same time there are many potential application of synthetic biology in health security. The riboregulators and synthetic biology tools developed here will provide underlying science and technology necessary to apply synthetic biology in LANL health security missions including developing countermeasures for emerging pathogens and biological weapons. This project will position LANL to compete as a strong science and technology player for new synthetic biology calls from DOE/EERE and DOE/BER in biofuels research, as well as DARPA and NIH funding for health security.

Progress

Riboregulators - To optimize the expression of enzymes in a metabolic pathway, we are developing two-component riboregulators that control the rate of translation and will be used to independently control the concentration of each enzyme in our engineered metabolic pathway. Our *cis*-repressor is designed to form a helix in the untranslated region of the messenger RNA, which occludes the ribosome-binding site, blocking translation. Thus, messenger RNAs for our target genes have the default state of gene expression turned off. Regulation of expression involves a second *trans*-activating RNA designed to hybridize with the messenger RNA in a way that frees the ribosome-binding site, allowing ribosome binding and protein synthesis. To test these concepts we prepared three constructs, each in a single copy plasmid using the Gibson assembly method, which allows for the efficient, simultaneous insertion of multiple DNA

fragments into a vector. In all three cases, transcription of the chloramphenicol acetyltransferase (CAT) gene, which imparts resistance to the antibiotic chloramphenicol, is controlled by the T7A1 promoter and T7 terminator. The first construct contained no riboregulator defining the maximum expression of our reporter gene under transcriptional control (defining the maximum on state), the second construct contained only the cis-repressor on the 5' end of the CAT reporter gene defining the level of expression when translational is off ("all off") and the third construct added the gene encoding the trans-activator with perfect complementarity to the cis-repressor defining the maximum on state with translational control (all on). In separate experiments *E. coli* was transformed with each the plasmids and the transformants were cultured in the presence of increasing concentration of chloramphenicol. These simple growth experiments allowed us to rapidly probe the structural features riboregulators as they relate to translational control of gene expression. Initial we found the level of thermodynamic stability of cis-repressor structure required to turn off translation and used this to design a true all off cis-repressor. We also defined the structural element of the trans-activator required to overcome the cis-repressor and reactivate translation. Using antibiotic resistance markers we have demonstrated the riboregulators can be used for translational control of gene expression. Specifically we have shown we can design riboregulators to control gene expression over a wide dynamic range (>250 fold) from completely "off" (zero expression) to completely "on" (transcriptional control only). We have developed orthogonal targeting sequences so we can independently control the expression multiple genes. Finally we have shown we can apply directed evolution of the trans-activator element of the riboregulator and select for expression of different levels of antibiotic resistance genes.

Pathway engineering – Our second main goal was to use known enzymes to engineer a more carbon- and energy-efficient pathway for lipid biosynthesis essential for biofuel production. We have developed a plan to demonstrate pathway optimization by directed evolution of riboregulators controlling translation of a five-gene pathway in an *E. coli* strain modified to require acetate for growth. In this *E. coli* strain, we have deleted the genes encoding for pyruvate dehydrogenase/oxidase making it require acetate as a source for acetyl-CoA. Adding back genes encoding our five-step pathway which includes genes for the enzymes, enolase PEP-carboxylase, malate dehydrogenase, malate thiokinase and malyl-CoA lyase will impart the ability to biosynthesize acetyl-CoA and will allow the strain to grow in the absence of acetate. To evaluate our progress toward pathway optimization, we will develop a full kinetic model of our engineered pathway. Toward this end we have

initiated a project to express, purify and characterize the kinetics of the enzymes in our pathway. To date we have demonstrated the expression and enzyme activity of all five of the enzymes. In addition we have crystalized and solved the structure of four of the enzymes. We also hope to transfer this five-gene pathway to a phototroph as many of the same DNA constructs used in the *E. coli* experiments can be used directly in the cyanobacteria; we are in process of demonstrating translational control of gene expression in *Synechococcus elongatus* using antibiotic resistance markers and constructing a strain with required pyruvate dehydrogenase deletion. In preparation for engineering a phototroph, we have established protocols for transformation and gene expression in *Synechococcus elongatus*.

Future Work

Using antibiotic resistance markers, we have now demonstrated riboregulators can be used effectively for translational control of gene expression. In FY14, we will continue to develop the riboregulator concept, by carrying out the directed evolution/selection experiment in a chemostat where we anticipate tighter selection of permissive sequences to better understand the relationship between the level translational control and the relative stability of RNA helices in the trans activator/cis repressor pair. We will continue to modify the linker region of the trans-activator linker region to better understand the mechanism of differential riboregulation and targeting specificity. As recommended by the review team, we will demonstrate the effect of turning on/off a riboregulator pair at different times in the growth cycle.

We will demonstrate pathway optimization by directed evolution of riboregulators controlling translation of a five-gene pathway in an *E. coli* strain modified to require acetate for growth. In this strain, we have deleted the genes encoding for pyruvate dehydrogenase/oxidase making it require acetate as a source for acetyl-CoA. Adding back genes encoding our four-step pathway which includes genes encoding the enzymes, enolase, PEP-carboxylase, malate dehydrogenase, malate thiokinase and malyl-CoA lyase will impart the ability to biosynthesize acetyl-CoA and will allow the strain to grow in the absence of acetate. Each of these genes will be under translational control of orthogonal trans-activator/cis-regulator pairs. We will evolve the trans-activators selecting for growth using a chemostat. We also hope to transfer this five-gene pathway to a phototroph as many of the same DNA constructs used in the *E. coli* experiments can be used directly in the cyanobacteria; we are in process of demonstrating translational control of gene expression in *Synechococcus elongatus* using antibiotic resistance markers and constructing a strain with the gene for pyruvate dehydrogenase deleted

which is necessary to test our pathway.

Conclusion

We will develop a family of riboregulators that can be used for translational regulation of the expression of each of the enzymes in a complete metabolic pathway, and demonstrate a strategy for the simultaneous directed evolution of riboregulators to optimize the expression of the enzymes to maximize flux through a metabolic pathway.

We will use known enzymes to engineer a more carbon- and energy-efficient pathway for lipid biosynthesis essential for biofuel production. In addition, we will use the directed evolution of riboregulators strategy developed above to optimize growth and lipid production in *Synechococcus elongates*, a cyanobacterium.

Publications

- Fox, D. T.. Maximization of Isoprenoid Production and Extraction in a Model Organism. Presented at Algae Biomass Summit. (Orlando, FL, 1-3 Oct. 2013).
- Fox, D. T.. Biocatalytic Production of Commodity Chemicals. Presented at American Society of Microbiology. (Boston, MA, 17-20 May 2014).
- Gonzalez, J. M., R. Marti-Arbona, and C. J. Unkefer. Crystal structure of phosphoenolpyruvate carboxylase from *Methylobacterium extorquens*. Presented at American Crystallographic Association Annual Meeting. (Albuquerque, NM, 24-28 May 2014).
- Hall, R. S., R. Marti-Arbona, S. P. Hennesly, T. S. Maity, F. Mu, J. M. Dunbar, C. J. Unkefer, and P. J. Unkefer. In-vitro Characterization of an L-Kynurenine-Responsive Transcription Regulator of the Oxidative Tryptophan Degradation Pathway in *Burkholderia xenovorans*. 2013. *Journal of Molecular Biology Research*. 3 (1): 55.
- Hayes, R. L., J. K. Noel, U. Mohanty, P. C. Whitford, S. P. Hennesly, and K. Y. Sanbonmatsu. Molecular simulation captures free energy stabilization of RNA by Mg²⁺. 2014. *Biophysical Journal*. 106 (7): 1508.
- Hennesly, S. P., I. V. Novikova, and K. Y. Sanbonmatsu. The expression platform and the aptamer: cooperativity between Mg²⁺ and ligand in the SAM-I riboswitch. 2013. *NUCLEIC ACIDS RESEARCH*. 41 (3): 1922.
- Hennesly, S. P., I. V. Novikova, and K. Y. Sanbonmatsu. The expression platform and the aptamer: cooperativity between Mg²⁺ and ligand in the SAM-I riboswitch. 2013. *Nucleic Acids Research*. 41 (3): 1922.
- Jarchow-Choy, S. K., A. T. Koppisch, and D. T. Fox. Synthetic Routes to Methylerythritol Phosphate Pathway Intermediates and Downstream Isoprenoids. 2014. *CURRENT ORGANIC CHEMISTRY*. 18 (8): 1050.
- Jarchow-Choy, S., D. Fox, E. Schmidt, A. Koppisch, R. Marti-Arbona, and C. Unkefer. Monitoring the distribution of isoprenoid products from the MEP pathway in algae and cyanobacteria. 2013. *ABSTRACTS OF PAPERS OF THE AMERICAN CHEMICAL SOCIETY*. 245: -.
- Jha, R. K., T. L. Kern, D. T. Fox, and C. E. M. Strauss. Engineering an *Acinetobacter* regulon for biosensing and high-throughput enzyme screening in *E-coli* via flow cytometry. 2014. *NUCLEIC ACIDS RESEARCH*. 42 (12): 8150.
- Marti-Arbona, R., F. Mu, F. Nowak-Lovato, M. S. Wren, P. J. Unkefer, and C. J. Unkefer. • "Automated Genomic Context Analysis and Experimental Validation Platform for Discovery of Prokaryote Transcriptional Regulator Functions" . *BMC Genomics*.
- Marti-Arbona, R., T. S. Maity, J. M. Dunbar, C. J. Unkefer, and P. J. Unkefer. Discovery of a Choline-Responsive Transcriptional Regulator in *Burkholderia xenovorans*. 2013. *Journal of Molecular Biology Research* . 3 (1): 91.
- Nguyen, T. T., R. Marti-Arbona, R. S. Hall, T. Maity, Y. E. Valdez, J. M. Dunbar, C. J. Unkefer, and P. J. Unkefer. Identification and In-vivo Characterization of a Novel OhrR Transcriptional Regulator in *Burkholderia xenovorans* LB400. 2013. *Journal of Molecular Biology Research*. 3 (1): 37.
- Novikova, I. V., A. Dharap, S. P. Hennesly, and K. Y. Sanbonmatsu. Shotgun secondary structure determination of long non-coding RNAs. 2013. *Methods*. 63: 170.
- Novikova, I. V., S. P. Hennesly, and K. Y. Sanbonmatsu. Sizing up long non-coding RNAs: Do lncRNAs have secondary and tertiary structure? . 2012. *BioArchitecture*. 2 (6): 189.
- Novikova, I. V., S. P. Hennesly, and K. Y. Sanbonmatsu. . Experimentally determined secondary structures of cancer-related long non-coding RNAs. 013. In 245th ACS National Meeting & Exposition. (New Orleans, 7-11 April, 2013). , p. *PHYS. Abstracts of Papers: ACS*.
- Novikova, I. V., S. P. Hennesly, and K. Y. Sanbonmatsu. Tackling Structures of Long Noncoding RNAs. 2013. *INTERNATIONAL JOURNAL OF MOLECULAR SCIENCES*. 14 (12): 23672.
- Novikova, I. V., S. P. Hennesly, C. S. Tung, and K. Y. Sanbonmatsu. Rise of the RNA machines: Exploring the structure of long non-coding RNAs. 2013. *Journal of Molecular Biology*. 425: 3731.
- Sanbonmatsu, K. Y.. Rise of the RNA Machines: Long Non-Coding RNAs. Invited presentation at 10th Horizons

in Molecular Biology Conference International . (Max Planck Institute, Gottingen, Germany, Sept 9-12 2013).

Sanbonmatsu, K. Y.. Integrating simulations and experiments of the SAM-I riboswitch. Invited presentation at RNA Dynamics. (Telluride, Colorado, 22-26 July, 2013).

Sanbonmatsu, K. Y.. Large-scale simulations of biomolecular machines. Invited presentation at Biosupercomputing Symposium. (Tokyo Japan, December 2012).

Sanbonmatsu, K. Y.. Understanding the atomistic mechanism of magnesium effects of RNA dynamics. Invited presentation at Mini-symposium on Modeling, Simulation and Function of Biomolecular Assemblies. (Tokyo University, Tokyo Japan, November 2012).

Sanbonmatsu, K. Y.. Computational & Experimental Studies: Ribosomes, Riboswitches & Long non-coding RNAs. Invited presentation at Fourth Annual Summer Symposium on Cellular Dynamics of Macromolecular Complexes. (Montreal, Canada, 3-8 June 2014).

Sanbonmatsu, K. Y.. Structural Studies of Intact LncRNAs in Plants and Mammals. Invited presentation at Keystone Symposium: Long non-coding RNAs: Marching towards Mechanism. (Santa Fe, NM, 2-6 March 2014).

Twary, S. N., S. R. Starckenburg, C. J. Unkefer, and M. A. Alvarez. Comparative transcriptomics across algal species after induced lipid accumulation. Presented at International Conference on Algal Biomass, Biofuels and Bioproducts. (Santa Fe, NM, 15-18 June 2014).

Discovery Science of Hydraulic Fracturing: Innovative Working Fluids and Their Interactions with Rocks, Fractures, and High Value Hydro-carbons

Hari S. Viswanathan
20140002DR

Introduction

Shale gas is an unconventional fossil energy resource that is already having a profound impact on US energy independence and is projected to last for at least 100 years. Production of methane and other hydrocarbons from low permeability shale involves hydrofracturing of rock, establishing fracture connectivity, and multiphase fluid-flow and reaction processes all of which are poorly understood. The result is inefficient extraction with many environmental concerns. These phenomena are part of a broader class of problems involving coupled fluid flow and fractures that are critical to other energy security areas such as shale oil, geothermal, carbon sequestration, and nuclear waste disposal as well as crack propagation in weapons applications. A science-based capability is required to quantify the governing mesoscale fluid-solid interactions, including microstructural control of fracture patterns and the interaction of engineered fluids with hydrocarbon flow. These interactions depend on coupled thermo-hydro-mechanical-chemical (THMC) processes over scales from microns to tens of meters. Determining the key mechanisms in subsurface THMC systems has been impeded due to the lack of sophisticated experimental methods to measure fracture aperture and connectivity, multiphase permeability, and chemical exchange capacities at the high temperature, pressure, and stresses present in the subsurface. Our goal is to use unique LANL microfluidic and triaxial core flood experiments integrated with state-of-the-art numerical simulation to reveal the fundamental dynamics of fracture-fluid interactions to transform fracking from ad hoc to safe and predictable approaches that are based on solid scientific understanding. We will develop CO₂-based fracturing fluids and fracturing techniques to enhance production, greatly reduce waste water, while simultaneously sequestering CO₂.

Benefit to National Security Missions

Significant R&D is required to increase shale gas produc-

tion while reducing environmental impacts associated with aqueous hydraulic fracturing. The proposed work could shift the momentum toward greater large scale industry interest in “greener” fracturing fluids leading to greater public acceptance of fracking. Discoveries in fluid properties, rock properties, and their integrated interactions will be required. The proposed study brings together leading scientists from C, EES, MPA and T divisions to develop and apply new experimental methods in observing rock fracturing to efficiently extract hydrocarbons in combination with novel, benchmarked models that will enhance US national and energy security. Success in the proposed work will position LANL at the forefront of shale-gas technology, creating opportunities for significant industrial partnerships, and a leadership role in DOE programs in shale gas. This work also maintains capability for test containment and leakage prediction in the unlikely case of a future US nuclear test, or the more likely case of foreign testing. If the need for resumed testing should ever arise, the capability for understanding underground transport will just as critical as it once was.

Progress

This project is in its first year. We are pursuing the following research questions using a combination of experiments and models at the pore, core and reservoir scales.

1. How do varying stress conditions, rock properties and working fluids govern fracture patterns and hydrocarbon productivity?
2. How big a problem is water in hydraulic fracturing and how much better are alternative working fluids such as scCO₂?
3. What mechanisms govern the decline in production? Poor fracture connectivity or fracturing closing, or slow gas release due to a) matrix diffusion, b) desorption of methane absorbed to organics? , c) flow blocking?

All project goals are on track with the overall goal being to use unique LANL experiments (e.g. microfluidics and triaxial corefloods) integrated with state-of-the-art numerical simulation (at the pore, core and reservoir scale) to reveal the fundamental dynamics of fracture-fluid interactions to transform fracking from ad hoc to safe and predictable approaches. We have submitted and are preparing to submit a publications in these areas (shown below). A few examples are below broken down by the scale at which we are studying these issues.

Pore Scale

Lattice Boltzmann simulations at the porescale have been investigating mass transport in the bulk rock matrix and the fractured rock.

Progress has been made to etch and seal microfluidic wafers using glass and real rock samples. We will next test these wafers with our microfluidics rig.

Core Scale

The triaxial coreflood has been used to conduct fracture and fluid flow experiments in shale and cement samples. Experimentalists and modelers have been working together to predict fracture propagation due to fluids and varying stress conditions.

Reservoir Scale

We have implemented discrete fracture networks into our reservoir scale model to simulate hydrocarbon production. We have shown that the initial stages of production are controlled by drainage of large fractures.

We have also been performing work to determine the fate of water at hydraulic fracturing sites. We have determined how much water can be taken up the the fractures and the bulk rock matrix.

Finally were are writing a perspective piece comparing CO₂ and water as fracturing fluids.

Future Work

Task 1: We will continue to conduct triaxial coreflood experiments to characterize fracture patterns and apertures under different stress conditions as well as using different working fluids (e.g. water and CO₂). We plan move the triaxial apparatus to either LANSCE or AET in order to measure fracture properties under in situ conditions. So far we have been measuring these parameters ex situ.

Task 2: We will continue to develop models of fracture propagation modeling work that are validated by task 1. We want models that are accurate for fractures that propa-

gate the multiple interfaces prevalent in shale. In the next year, we are coupling a full fluid solver into the fracture propagation code.

Task 3: We will continue to conduct microfluidic experiments of sweep efficiency. We have conducted experiments with real rock etched with fracture patterns from CINT under ambient conditions. We have also conducted high pressure experiments with standard glass and silica micromodels. In the next FY, we hope to perform high pressure microfluidic experiments with real rock.

Task 4: In the next FY, we will continue to develop models that simulate mass transfer from the damage zone around fractures to the fractures. We will also enhance our lattice Boltzmann models multiphase flow capabilities and benchmark them against task 3.

Task 5: We have developed discrete fracture network modeling capability and incorporated it into our reservoir simulator. In the next FY, we will be enhancing the reservoir model to include desorption of hydrocarbon from organics, fracture-matrix interaction and the effects of multi-phase flow blocking.

Task 6: We will calibrate our reservoir simulator to production curves from our industrial collaborator Apache.

Conclusion

Fracking phenomena involve fluid-solid interactions embedded within coupled thermo-hydro-mechanical-chemical processes over scales from microns to tens of meters. The proposed work is part of a broader class of complex systems involving coupled fluid flow and fractures that are critical to energy security, such as shale oil, geothermal, carbon sequestration, and nuclear waste disposal, as well as, crack propagation in weapons and materials applications. Predicting and controlling fracture propagation due to fluid-solid interaction would be transformative, with significant impact beyond the hydraulic fracturing of rock.

Publications

Bazant, Z., M. Salviato, V. T. Chau, H. S. Viswanathan, and A. Zubelewicz. Why fracking works. 2014. *Journal of Applied Mechanics*. 81 (10): 101010.

Carey, J. W., H. Mori, D. Brown, and R. Pawar. Geomechanical behavior of caprock and cement: Plasticity in hydrodynamic seals. 2014. *Energy Procedia*. : 5671.

Carey, J. W., Z. Lei, E. Rougier, H. Mori, and H. S. Viswanathan. Fracture-permeability behavior of shale. *Journal of Unconventional Oil and Gas Resources*.

- Chen, L., L. Zhang, Q. Kang, H. Viswanathan, J. Yao, and W. Tao. Nanoscale simulation of shale transport properties using the lattice Boltzmann method: permeability and diffusivity. To appear in Scientific Reports.
- Chen, L., Q. Kang, B. Carey, and W. Tao. Pore-scale study of diffusion–reaction processes involving dissolution and precipitation using the lattice Boltzmann method. 2014. *International Journal of Heat and Mass Transfer*. 75: 483.
- Chen, L., Q. Kang, H. Deng, J. W. Carey, and W. Tao. Mesoscopic study of the formation of pseudomorphs with presence of chemical fluids. 2014. *Geosciences Journal*. : 1.
- Chen, L., Q. Kang, H. S. Viswanathan, and W. Tao. Pore-scale study of dissolution-induced changes in hydrologic properties of rocks with binary minerals. 2014. *Water Resources Research*. (50): 1.
- Chen, L., Q. Kang, Y. Mu, Y. He, and W. Tao. A critical review of the pseudopotential multiphase lattice Boltzmann model: Methods and applications. 2014. *International Journal of Heat and Mass Transfer*. 76: 210.
- Chen, L., W. Fang, Q. Kang, J. Hyman, H. S. Viswanathan, and W. Tao. A generalized lattice Boltzmann model for flow through tight porous media with Klinkenberg’s effect. *Physical Review E*.
- Chen, Y., Q. Kang, Q. Cai, M. Wang, and D. Zhang. Lattice Boltzmann Simulation of Particle Motion in Binary Immiscible Fluids. *Computational Geosciences*.
- Hyman, J. D., A. Guadagnini, and C. L. Winter. Statistical Scaling of Geometric Characteristics in Stochastically Generated Pore Microstructures. *Computational Geosciences*.
- Hyman, J. D., S. L. Painter, H. S. Viswanathan, N. Makedonska, and S. Karra. Influence of Injection Mode in Kilometer Scale Three Dimensional Discrete Fracture Networks. *Water Resources Research*.
- Jackson, R. B., A. Vengosh, J. W. Carey, R. Davies, F. O’Sullivan, and G. Petron. The environmental costs and benefits of fracking. 2014. *Annual Review of Environment and Resources*. : 1.
- Kang, Q., L. Chen, A. J. Valocchi, and H. S. Viswanathan. Pore-scale study of dissolution-induced changes in permeability and porosity of porous media. 2014. *Journal of Hydrology*. 517: 1049.
- Karra, S., N. Makedonska, H. S. Viswanathan, S. Painter, and J. Hyman. Effect of advective flow in fractures and matrix diffusion on natural gas production. *Water Resources Research*.
- Kelkar, S., K. Lewis, S. Karra, G. Zyvoloski, S. Rapaka, H. S. Viswanathan, P. K. Mishra, S. Chu, D. Coblenz, and R. Pawar. A simulator for modeling coupled thermo-hydro-mechanical processes in subsurface geological media. 2014. *International Journal of Rock Mechanics and Mining Sciences*. : 569.
- Liu, H., A. J. Valocchi, C. Werth, Q. Kang, and M. Oostrom. Pore-scale simulation of liquid CO₂ displacement of water using a two-phase lattice Boltzmann model. 2014. *Advances in Water Resources*. 73: 144.
- Liu, H., Q. Kang, C. R. Leonardi, B. D. Jones, S. Schmieschek, A. Narváez, J. R. Williams, A. J. Valocchi, and J. Harting. Multiphase lattice Boltzmann simulations for porous media applications--a review. 2014. arXiv preprint arXiv:1404.7523. : 1.
- Middleton, R. S., J. W. Carey, R. Currier, J. D. Hyman, Q. Kang, J. Jimenez-Martinez, M. L. Porter, and H. S. Viswanathan. Shale gas and non-aqueous fracturing fluids: opportunities and challenges for supercritical CO₂. *Applied Energy*.
- Middleton, R., H. Viswanathan, R. Currier, and R. Gupta. CO₂ as a fracturing fluid. To appear in *Energy Procedia*.
- Oostrom, M., Y. Mehmani, P. Romero-Gomez, Y. Tang, H. Liu, H. Yoon, Q. Kang, V. Joekar-Niasar, M. Balhoff, and T. Dewers. Pore-scale and continuum simulations of solute transport micromodel benchmark experiments. 2014. *Computational Geosciences*. 4-0: 1.
- Zhou, L., E. Rougier, E. E. Knight, and A. Munjiza. A framework for grand scale parallelization of the combined finite discrete element method in 2D. 2014. *Computational Particle Mechanics*. : 307.
- Zubelewicz, A., E. Rougier, M. Ostojka-Starewski, E. E. Knight, C. Bradley, and H. S. Viswanathan. A mechanisms-based model for dynamic behavior and fracture of geomaterials. 2014. *International Journal of Rock Mechanics and Mining Sciences*. : 277.

Combating Antibiotic Resistance: Targeting Efflux Pump Systems at Multiple Scales

Sandrasegaram Gnanakaran
20140121DR

Introduction

Multi-drug resistant bacteria such as *Staphylococcus aureus* and *Mycobacterium tuberculosis* are emerging at an alarming rate, yet new antibiotics are few and far between. The scarcity of new antibiotics is in part due to a lack of understanding of the mechanisms of multi-drug resistance. Antibiotic efflux is one of the most important mechanisms of bacterial multi-drug resistance. Antibiotics are pumped out of the cell by efflux pumps containing three protein components. We propose to study the highly active efflux pumps in *Burkholderia pseudomallei*, a high-priority bio-threat agent. X-ray crystallography and molecular dynamics simulation will be valuable for understanding how the efflux pump protein complexes are formed spanning the inner-membrane, periplasm, and outer-membrane, and how the opening-closure dynamics of the complex determines the rate of efflux of an antibiotic. Gene and protein expression studies will be essential to identify how the presence of an antibiotic turns the gene circuits on or off to regulate the expression of the active efflux pumps, thereby determining the net efflux. The same efflux pumps are also responsible for releasing small metabolites, such as quorum-sensing molecules, which act as global regulators of genes belonging to pathways critical to bacterial growth, viability, and morphology. Therefore, gene expression and pathways analyses are essential to determine how the release of these metabolites offers additional fitness to the bacterium in terms of enhanced growth and viability. Integrated modeling of structural, genetic, and cellular processes will provide valuable insight into how these processes are coupled and how this coupling imparts overall bacterial fitness under the selection pressure from antibiotics.

Benefit to National Security Missions

Countermeasure development for treating pathogen infection is central to our project, as efflux pumps are the predominant form of multi-drug efflux, and understand-

ing gained in this project should lead to novel strategies of antibiotic therapy. Because we chose to focus on a biothreat agent (which is also of global public health concern), *Burkholderia pseudomallei*, this project will be of interest to the biodefense mission of DOE. The multi-scale nature of this work, coupling genetic, regulatory, and biomolecular structure / function aspects in one study will contribute to advances in basic energy science (biofuels) and basic biomedical research.

Progress

At the structural level, our efforts focused on understanding the mechanistic details of the efflux pump. The purpose of the experimental structural biology effort is to determine three-dimensional structures of efflux pumps from pathogenic bacteria. In our preliminary studies we determined the structure of the inner-membrane protein AcrB from *E. coli* complexed with the drug Linezolid and developed the capability to work with membrane proteins. During the current year of the project we obtained synthetic genes for 9 efflux pump proteins from the pathogen *Burkholderia pseudomallei*. We are now pursuing identification of conditions for optimal production of these proteins in *E. coli* and have found conditions for one of them.

To date, the high-resolution structure of an entire efflux pump complex has remained elusive. The purpose of theoretical structural biology effort is to fill this gap by combining data from various experimental techniques with the available crystal structure data to construct atomic-level resolution models of the full efflux pump complex and to estimate efflux rates. This year we developed a fast and consistent method for constructing all-atom tripartite efflux pump structures and used these structures to perform coarse-grained, geometric simulations of drug translocation. We showed that both small and large drugs can translocate through a vestibule accessible from the periplasm whereas only small drugs

may enter the pump through a channel from the cytoplasmic leaflet of the inner membrane.

At the genetic level, our efforts focused on modeling the dynamic response of bacteria to antibiotics via cellular regulation, including genetic regulation. Mathematical modeling at this level establishes the couplings needed for integration of structural and cellular levels. We assessed the model of efflux and bacterial survival in *P. aeruginosa* that was developed in the preliminary studies. We found that the essential behavior could be preserved in a coarse-grained model that retains the most important mechanisms of efflux, cell growth, and cell death. We used the model to analyze preliminary experimental data on antibiotic accumulation and cell death, and determined that additional information is required to draw conclusions about the regulatory mechanisms involved in efflux. We then extended the model to include regulated production of quorum sensing models and the subsequent switching of some cells to a more drug-resistant state (e.g. associated with biofilms).

At the cellular level, our efforts focused on establishing the relationship between efflux pumps and biofilm formation. During the current year, we tested and validated our hypothesis that efflux pumps are not merely protein complexes that transport drugs out of the bacteria, they can also facilitate the formation of bacterial biofilm, a physiological state that provides additional resistance to not only drugs but also to host immune defense. We performed several studies on nascent and mature biofilms of *P. aeruginosa* in the presence and absence of the drug ciprofloxacin. We measured the depth of the biofilms for different strains of *P. aeruginosa* with normal, lower, and elevated levels of efflux pumps using spectrophotometric and imaging techniques. We observed that the efflux pumps are expressed by *P. aeruginosa* at higher levels when the biofilm is better-developed, especially in the presence of a drug. Also the bacterial survival is positively correlated with both elevated levels of efflux pumps and the maturity of the biofilms. Finally, biofilms with elevated levels of efflux pumps were shown to be better able to counter host neutrophils (killers of bacteria).

The genomic analysis task examined in great detail how well the properties measured in the well-studied organism, *P. aeruginosa*, are expected to predict molecular mechanisms in the biothreat-related pathogen of primary interest to this project, *B. pseudomallei* and its near-neighbor, *B. thailandensis*. Full-genome alignments of the two Burkholderia species were performed, and the 100 genes of each that we determined to be of most relevance to the cellular mechanisms of antibiotic resistance were identi-

fied and related to existing data sets and literature. Several iterations of relating these genes to the coarse-grained variables from the genetic model occurred.

Future Work

During the next year we plan to optimize expression of all the efflux proteins that we have synthesized and to identify suitable detergents for efficient solubilization of the resulting proteins. This will provide the starting point for crystallization and structure determination of these challenging membrane proteins. Also at the structural level, our efforts will focus on using molecular dynamics simulations to estimate relative rates of drug translocation through the efflux pumps, as needed for the integrated mathematical framework. Additionally, we will integrate the mechanistic kinetic model of drug translocation into the existing genetic and cellular regulation integration framework. At the cellular level, we will incorporate the gene expression profiles from the rt-qPCR on Fluidigm platform for nascent and mature biofilms for different strains of *P. aeruginosa* into the integrated mathematical framework in a quantitative manner.

Conclusion

We will characterize three coupled processes: expulsion of antibiotics from the cell by efflux pumps, stimulation of efflux pump production by antibiotics, and efflux pump-mediated biofilm formation that shields the bacterium from antibiotics. We will combine experimental and theoretical approaches to develop the first predictive model of this system. This model will integrate these molecular, genetic, and cellular processes and will identify critical elements of each process that can inactivate drug resistance. The capability for integrated modeling of a complex adaptive molecular transport system will have broad applications in biosecurity, biofuel production, and microbial clearance of toxic material.

Publications

- Ganguly, K., M. Wren, J. Phillips, P. Pardington, H. Schweizer, M. Wall, S. Gnanakaran, and G. Gupta. Interdependence of multi drug efflux pumps and quorum sensing system in *Pseudomonas*. 2014. In International Congress on Infectious Diseases. (Cape Town, South Africa, 2-6 April). Vol. 21, Suppl 1, Edition, p. 92. International Journal on Infectious Diseases: --.
- Hung, L. W., H. B. Kim, S. Murakami, G. Gupta, C. Y. Kim, and T. C. Terwilliger. Crystal structure of AcrB complexed with linezolid at 3.5 Å resolution. . 2014. Journal of Structural and Functional Genomics. . 14 (2): 71.

Phillips, J. L., Ganguly, Wren, Gupta, M. E. Wall, and

Gnanakaran. Systems Level Study of Bacterial Multi-Drug Resistance from Efflux Machinery. 2014. BIOPHYSICAL JOURNAL. 106 (2): 791A.

Phillips, J., and S. Gnanakaran. A data-driven approach to modeling the tripartite structure of multidrug resistance efflux pumps. . To appear in Proteins: Structure, Function, and Bioinformatics..

Quantitative Biology: From Molecules to Cellular Function

Robert E. Ecke
20140566DR

Introduction

Biology is continuously transforming from a qualitative science involving observations and associations to one where quantitative models are necessary for both fundamental understanding and predictive capability. These theoretical and computational models build on methods and concepts in physics, mathematics, and chemistry and are becoming increasingly influential in many areas of biology. LANL has a long tradition in theoretical biology dating back to the 1970s and more recently CNLS has helped establish an international presence in quantitative biology through the q-bio summer school and annual conference and through its continuing emphasis on applying quantitative methodology to challenging biological problems ranging from the structure and dynamics of individual macromolecules, e.g., DNA, RNA, proteins, etc., to the interacting biochemical reactions that drive cellular function. Our research will build bridges at the mesoscale between macromolecular scales and complex cellular function by taking advantage of coarse graining (averaging) over degrees of freedom at microscales that retain the impact on large scale (cellular) activity. By taking advantage of the quantitative expertise in CNLS and at LANL, we continue to emphasize opportunities with applications to infectious disease mitigation and bio-surveillance, to developing effective algal and cellulosic biofuels, and to develop fundamental understanding of cellular function over the scales from molecules to cells.

Benefit to National Security Missions

The fundamental discovery science associated with the CNLS biology effort has potential applications in energy security via algal and cellulosic biofuels modeling, in biosecurity through understanding and modeling of infectious disease epidemiology and cellular mechanisms, and in health related areas such as the ability to design effective vaccines using biological models of cellular function.

Progress

This year we made initial progress in understanding how to design a specific type of drug for HIV and studied how cells become drug resistant by transporting antibiotics out of the cell using efflux pumps. We also began studying biochemical processes for cellulose conversion to fuels.

Efflux pumps are transporters of toxics and antibiotics out of the cell. We developed a new homology modeling protocol, performed simulations using that model, and wrote up the results for an article sent to the journal *PROTEINS: Structure, Function and Bioinformatics*. We've also started developing a more efficient coarse-grained model of the efflux pumps that will be parametrized using higher-resolution molecular dynamics simulations.

Eliciting broadly neutralizing antibodies is one of the most promising vaccine strategy candidates for HIV. With collaborators we are pursuing artificial design of HIV vaccines, which would increase the chances of eliciting broadly neutralizing antibodies. Our approach is to first investigate the amino acid signatures in HIV Envelope protein sequences that are associated with higher sensitivity to known broadly neutralizing antibodies. Then, by introducing these signatures in the backbone of a natural HIV strain, we are designing artificial constructs that are expected to have higher sensitivity to broadly neutralizing antibodies. We are preparing the manuscript "Understanding the origin of co-evolutionary relationships in HIV Env -- a comparison of co-evolutionary and structural relationships" which describes our approach.

In biofuels we are investigating the energy conversion processes in photosynthesis and catalysts for cellulose conversion to sugars. We are using computer simulations to study protein design strategies to develop novel pH-regulated protein conformational switches. The hope is that these switches will accelerate the dissipation of

excess energy harvested by the photosynthetic antenna systems so as to reduce photodamage and increase biomass productivity. The primary challenge we are addressing is accelerating the slow (2-10 minutes) induction of non-photochemical quenching mechanisms that dissipate excess energy captured during high light conditions to less than one minute.

Future Work

Our innovative approach to improve cellulose hydrolysis relies on using liquid ammonia to catalyze a structural crossover between different forms of cellulose where the resultant structure enhances enzymatic hydrolysis rates by a factor of five. We will provide a theoretical rationale for the ongoing work on designer cellulases, improve current kinetic models for enzyme-cellulose interactions, and develop new predictive models based on the ongoing experimental studies. Our results will help improve the efficiency of converting cellulose to biofuels.

HIV evolves rapidly and can escape antibodies produced by the immune system. One prevention strategy is to develop a vaccination schedule that elicits broad antibody response that is effective against multiple HIV strains. By building a model of within-host dynamics that captures the emergence of strain-specific antibody response, we will investigate whether sequential vaccination or single multi-strain vaccination induces stronger and/or broader response. We will also address the evolution of drug resistance in HCV.

Cellular function is built on molecular motion at the smallest scale where full-atom molecular dynamics is an effective tool for characterizing and understanding the physics and biology of those dynamics. Full simulation of even molecular complexes is, however, far beyond current computational capabilities. Thus, one needs a scheme for saving the important degrees of freedom while averaging over other less important motions, a process known as coarse graining. We will develop effective coarse graining strategies for modeling macromolecular complexes in bacteria and introduce advances from computer science to attain more efficient simulations that will provide new insights into mesoscale cellular function.

Conclusion

We will combine experimental probes with simulation/modeling to characterize biomolecular environments that will allow evaluation of potential drug design. We will develop mesoscopic models that bridge scales in biofuel-relevant algae systems and provide a molecular level understanding and design principles for engineering more effective cellulosic biomass. We will develop multiscale

models of pathogenesis in bacteria. We will use novel mathematical methods to improve rule-based methodology applied to bio-chemical reaction networks and employ them to understand and characterize specific cellular mechanisms. We will construct high-level models of infectious diseases including HIV and HCV based on systems-level understanding of immune response.

Publications

- Abbink, P., L. Maxfield, D. Nganga, E. Borducchi, M. Iampietro, C. Bricault, J. Tiegler, S. Blackmore, L. Parenteau, K. Wagh, S. Handley, G. Zhao, H. Virgin, B. Korber, and D. Barouch. Plasma IgG to linear epitopes in the V2 and V3 regions of HIV-1 gp120 correlate with a reduced risk of infection in the RV144 vaccine efficacy trial. *Journal of Virology*.
- Chylek, L. A., D. A. Holowka, B. A. Baird, and W. S. Hlavacek. An Interaction Library for the FcεRI Signaling Network. 2014. *Frontiers in Immunology*. 5: 172.
- Chylek, L. A., L. A. Harris, C. Tung, J. R. Faeder, C. F. Lopez, and W. S. Hlavacek. Rule-based modeling: a computational approach for studying biomolecular site dynamics in cell signaling systems. 2014. *Wiley Interdisciplinary Reviews: Systems Biology and Medicine*. 6 (1): 13.
- Chylek, L. A., V. Akimov, J. Dengiel, K. T. G. Rigbolt, B. Hu, W. S. Hlavacek, and B. Blagoev. Phosphorylation site dynamics of early T-cell receptor signaling. 2014. *PLoS One*. 9: e104240.
- Giorgi, E. E., D. O. Stram, D. Taverna, S. D. Turner, F. Schumacher, C. A. Haiman, A. Lum-Jones, M. Tirikainen, C. Caberto, D. Duggan, B. E. Henderson, L. Le Marchand, and I. Cheng. Fine-Mapping IGF1 and Prostate Cancer Risk in African Americans: The Multiethnic Cohort Study. 2014. *Cancer Epidemiology, Biomarkers & Prevention: A Publication of the American Association for Cancer Research, Cosponsored by the American Society of Preventive Oncology*. 23 (9): 1928.
- Gottardo, R., R. T. Baller, B. T. Korber, S. Gnanakaran, J. Phillips, X. Shen, G. D. Tomaras, E. Turk, G. Imholte, L. Eckler, H. Wenschuh, J. Zerweck, K. Greene, H. Gao, P. W. Berman, D. Francis, F. Sinangil, C. Lee, S. Nitayaphan, S. Rerks-Ngarm, J. Kaewjungawal, P. Pitsuttithum, J. Tartaglia, M. L. Robb, N. L. Michael, J. H. Kim, S. Zolla-Pazner, B. F. Haynes, J. R. Mascola, S. Self, P. Gilbert, and D. C. Montefiori. Plasma IgG to linear epitopes in the V2 and V3 regions of HIV-1 gp120 correlate with a reduced risk of infection in the RV144 vaccine efficacy trial. 2013. *PLoS One*. : e75665.
- Lopatina, L. M., and J. V. Selinger. Polymer-disordered liquid crystals: Susceptibility to an electric field. 2013.

Physical Review E. 88: 062510.

- Lopez, C., A. Sethi, B. Goldstein, B. Wilson, and S. Gnanakaran. Membrane-mediated regulation of the intrinsically disordered CD3_ cytoplasmic tail of the TCR. *Biophysical Journal*.
- Lopez, C., G. Bellesia, A. Redondo, P. Langan, C. Shishir, B. Dale, S. Marrink, S. Gnanakaran, and S. Martini. Coarse-grained model for crystalline cellulose microfibrils. To appear in *Journal of Physical Chemistry*.
- Phillips, J. L., and S. Gnanakaran. A Data-driven approach to modeling the tripartite structure of multidrug resistance efflux pumps. 2014. *Proteins*.
- Reichhardt, C. J. Olson, L. M. Lopatina, X. Jia, and P. A. Johnson. Softening of granular packings with dynamic forcing. *Physical Review E*.
- Stieh, D. J., J. L. Phillips, P. M. Rogers, D. F. King, G. C. Cianci, S. A. Jeffs, S. Gnanakaran, and R. J. Shattock. Dynamic electrophoretic fingerprinting of the HIV-1 envelope glycoprotein. 2013. *Retrovirology*. 10 (1): 33.
- Veelen, V., Matthijs, S. Luo, and B. Simon. A Simple Model of Group Selection that Cannot Be Analyzed with Inclusive Fitness. 2014. *Social Science Research Network*.
- Westrate, L. M., J. A. Drocco, K. R. Martin, W. S. Hlavacek, and J. P. MacKeigan. Mitochondrial Morphological Features are Associated with Fission and Fusion Events. 2014. *PLoS ONE*. 9 (4): e95265.

Dynamic Earthquake Triggering, Granular Physics and Earthquake Forecasting: Determining the Physical Controls

Paul A. Johnson
20120007DR

Abstract

In 1992, a very strong earthquake of Magnitude (M) 7.3 occurred in Southern California near the town of Landers. This earthquake demonstrated a remarkable phenomenon: as seismic waves radiated from the event, other earthquakes were dynamically triggered, not only nearby but as far as 1000 km away, and elevated seismicity, termed delayed triggering or triggering event cascades, lasted for at least several months. Recent observations based on rapidly improving instrumentation show that a majority of earthquakes are dynamically triggered. That a large percentage of earthquakes are dynamically triggered provides a path towards a profound advance in seismology and earthquake hazard assessment. The traditional description of earthquakes relies on the classical plate-tectonic model of passive plates driven by mantle convection where stresses build up at locked-plate contacts that abruptly slip, leading to an earthquake caused by local stress conditions. The paradigm of dynamic earthquake triggering suggests a radical new understanding of earthquakes, implying that Earth's elastic system is far more complex than previously imagined with substantial long-range interactions among faults. In particular, dynamic stress from seismic waves can perturb fault systems that are in a critical state and force failure earlier in time relative to an unperturbed fault. Earthquake physics and hazard must be rethought, and we are doing just that. Our work indicates that granular physics of the fault core, fault "gouge", plays a key role in triggering. Other work by our team at the laboratory, simulation, and field scale strongly suggest that the nonlinear dynamical response of the gouge material is responsible for triggering. Because direct access to the fault is not possible, we have characterized the granular physics of triggering on laboratory scales using physical experiments and numerical simulations. We have bridged to Earth scales by comparing statistics of laboratory/simulation data with statistics of Earth observations that compare favorably, meaning our simulation and experimental work appear to capture important physics

of earthquakes and slip processes in general.

Background and Research Objectives

The March 11, 2011 M9.0 Tohoku-oki Earthquake, located ~100 km off the east coast of Honshu, was the fourth largest earthquake in recorded history, rupturing a 300 km segment of the plate boundary. The earthquake was due to ongoing subduction of oceanic crust beneath Japan. The slip magnitude between the two plates was 30-40 meters resulting in abrupt uplift of the seafloor, creating a tsunami that inundated port cities in eastern Honshu. A resultant nuclear disaster continues to unfold at nuclear power plants located in Fukushima. Despite the relatively sparse population in this region, the resulting economic losses are predicted to be about 4% of Japan's GDP. An earthquake of M8-9 in a densely populated region such as Seattle could have catastrophic effects on the US. Prior warning of increased earthquake probability during a specific time interval could significantly mitigate the potential economic disaster. It has recently been shown that a majority of earthquakes are dynamically triggered. Our unique perspective is that characterizing triggering leads to fundamentally new means of earthquake forecasting.

The Problem: Although earthquake forecasting is a highly complex, unsolved problem, significant advances may be possible in predicting time intervals of increased earthquake hazard. Institutes worldwide including the Working Group on California Earthquake Probabilities (WGCEP) currently do not include dynamic triggering in hazard estimates.

Our hypotheses are: a) Granular physics plays a key role in fault triggering in the laboratory and Earth. b) Isolating the triggering mechanism and characterizing its signatures will improve earthquake hazard analysis by determining the duration of enhanced earthquake probability from triggering. c) Triggering may be part of a more widespread crustal perturbation involving other

physical characteristics such as induced velocity changes.

Our project goals are to: a) Characterize the granular physics that we posit enables triggering, b) apply novel statistical approaches to infer increased earthquake risk owing to triggering and c) bridge laboratory scales to Earth scales.

Scientific Approach and Accomplishments

In order to characterize the physical conditions and time duration of triggering, our approach consists of combined laboratory, modeling and statistical analysis. A primary goal involves determining the crustal scale of seismic wave perturbation as well as the maximum time of increased hazard due to triggering, and developing tools to infer this information remotely in the laboratory, simulations and Earth. A simultaneous goal addresses the question—do large events trigger large events? Finally we must understand the physics of faulting and triggering and to do this, we have studied the fault gouge material.

State-of-the-art prediction, based on seismic hazard assessment for well-characterized faults, gives a probability that an earthquake of a given size will take place over a certain number of years. This approach was developed by the WGCEP to create the Uniform California Earthquake Rupture Forecast, version 2 (UCERF2). UCERF2 forecasts earthquake occurrence by: 1) mapping all known faults in California, 2) estimating the long-term slip rate on each fault using GPS measurements, 3) determining earthquake rates that are most consistent with the long-term slip rates on each fault, and 4) translating earthquake rates into probabilities of a given magnitude occurring in a 30 year time interval. This approach does not account for seismicity clustering in space and time (e.g., aftershocks), so earthquake probabilities do not vary with time over the 30 year interval. Currently, the WGCEP is developing UCERF3 which will include clustering of seismicity, improving treatment of uncertainty, and adding the possibility of operational earthquake forecasting where probabilities are updated as new seismic data accumulates. The methodology being developed for UCERF3 will also be used for forecasting in the earthquake-prone Pacific Northwest. Based on this approach, the ability to predict earthquakes on either an individual or a statistical basis remains remote.

Our view is fundamentally different: based on the new paradigm of long-range interactions, dynamic triggering of earthquakes is key to an advance in defining intervals of increased hazard, and statistical approaches applied to triggered events is key to providing the time intervals of increased risk. We are not claiming to predict earthquakes—we are defining a new paradigm that leads to characterizing periods of increased earthquake risk.

The most important discovery we have made is the observation of widespread crustal perturbation in Japan in response to the 2012 Magnitude 8.6 Indian Ocean Earthquake located at a distance of more than 1000 km. This event showed us that our hypothesis is correct—we observe marked changes in triggered seismicity and in crustal velocities due to the seismic wave perturbation from this event. Such an observation has never before been made outside of what is known as the aftershock region that occurs close to a seismic source. The effect was long lasting with duration of several weeks at least. Currently we are also, (i) studying in situ strain data that can be applied to see if there is associated earth crustal displacement as we predict; (ii) and beginning work on other potential triggering earthquakes such as the Great Chile earthquake (Maule) of 2010. We cannot know for certain whether or not the observation in Japan is unique in some manner until we have studied other regions. In any case, the observation of widespread perturbation in Japan suggests that such crustal perturbation may be very important and should be accounted for in tectonic modeling of how earthquakes are created, and moreover, should be considered in earthquake hazards analysis.

We have made great strides regarding the question of whether or not large earthquakes cluster globally, meaning one earthquake may trigger another. This is a highly controversial area of seismology and researchers have become intransigent in their conclusions. In short, our work shows tantalizing suggestion of clustering of large earthquakes and we have attempted to be as balanced as we possibly can in our findings; however, as the earthquake catalog of large events is so limited that the statistical confidence in this result is limited. Two papers have been published describing our analysis and another is in review.

Our supporting laboratory and numerical modeling work is highly advanced and as noted, exhibits similar scaling of earthquake magnitude as observed in the earth. We developed a new shearing experiment meant to simulate earthquakes applying what is known as ‘photoelasticity’ is highly advanced. Photoelasticity allows one to visually observe and interpret changes in the stresses on and off the model fault. Model earthquake triggering studies compare well to discrete element (DEM) numerical simulations. The second laboratory experiment we employ located at the Pennsylvania State University is opaque but has the advantage that it is three-dimensional, in contrast to the photoelastic experiment. We are also comparing the results to three-dimensional simulations using the same numerical simulation method and a number of publications have resulted. In short the model and experimental methods are being used to characterize shear along faults as well as

the effects of earthquake triggering. We statistically test whether or not the numerical simulations and experiments make sense in the context of real earthquakes, by looking at certain aspects of the laboratory and numerical simulation data that can be tested for scaling to the earth.

We have also characterized the processes that lead to instability in the fault 'core' or fault 'gouge' (the ground-up material that lies between fault blocks) induced by seismic waves. These studies include both numerical simulation and laboratory studies as well. From these studies we have characterized what the causes are for hypothesized long-lived changes in the earth that are due to seismic waves from other earthquakes. This long-lived behavior is responsible for the times of increased earthquake hazard.

We have and are working progressively more with external institutions that are intrigued by our unique vision and approach. These institutions include Pennsylvania State University, the United States Geological Survey, ETH Zurich (Switzerland), Bath University (UK), The 'Ecole Normal' and the Institute of Physics of the Globe in Paris (France), the University of Tokyo, Sendai University (Japan) and the University of Grenoble (France).

In summary, we have characterized the wave and material properties leading to triggering, 2) determined the statistics and duration of triggered failure versus the background seismicity at laboratory scale and in simulations, and 3) extended our results to Earth scale. Because large earthquakes pose serious risks to national energy and economic security, our work could have enormous societal impact by forecasting the imminence of these events.

Impact on National Missions

Large earthquakes pose serious risks to national energy and economic security through their deleterious impacts on infrastructure, a stated LANL mission area. The proposed work has an enormous societal/infrastructure impact by forecasting times of increased earthquake hazard. Triggering may also have significant import to Ground Based Nuclear Explosion Monitoring (GNEM)—clandestine events could be better hidden in regions of triggered event clustering. Our work improves understanding of seismic events as well as the exploitation, analysis, and interpretation of faint seismic signatures, and will develop new capability in this area. The work has broad application to vibration-induced failure in materials, aircraft, industrial machinery, and shaking of infrastructure from strong ground motion. The proposed work contributes to hazards analysis at LANL (CMRR). Moreover the work improves interdisciplinary capabilities at LANL by integrating efforts in seismology, geophysics, granular media, and continuum elastic-plastic deformation that are underpinning science

for a diverse set of LANL priorities including MaRIE. Our efforts to scale from laboratory/simulation to Earth also provide statistical tools to understand complex dynamics in multi-scale systems.

Publications

- Ben-Naim, E., E. G. Daub, and P. A. Johnson. Recurrence statistics of great earthquakes. 2013. *GEOPHYSICAL RESEARCH LETTERS*. 40 (12): 3021.
- Ben-Naim, E., and P. L. Krapivsky. Statistics of superior records. 2013. *PHYSICAL REVIEW E*. 88 (2): -.
- Daub, E., D. Shelly, R. Guyer, and P. Johnson. Brittle and ductile friction and the physics of tectonic tremor. 2011. *Geophysical Research Letters*. 38 (10): L10301.
- Daub, E., D. Trugman, and P. Johnson. Statistical tests on clustered global earthquake catalogs. *Journal of Geophysical Research*.
- Daub, E., E. Ben-Naim, R. Guyer, and P. Johnson. Are megaquakes clustered?. 2012. *Geophysical Research Letters*. 39 (6): L06308.
- Delorey, A., K. Chao, K. Obara, and P. Johnson. Experimental and numerical investigation of slip triggering in sheared granular layer as an analogue to dynamic earthquake triggering. *Nature Geoscience*.
- Elst, N. J. van der, E. E. Brodsky, P. Y. Le Bas, and P. A. Johnson. Auto-acoustic compaction in steady shear flows: Experimental evidence for suppression of shear dilatancy by internal acoustic vibration. 2012. *JOURNAL OF GEOPHYSICAL RESEARCH-SOLID EARTH*. 117: -.
- Ferdowsi, B., M. Griffa, R. A. Guyer, P. A. Johnson, C. Marone, and J. Carmeliet. Microslips as precursors of large slip events in the stick-slip dynamics of sheared granular layers: A discrete element model analysis. 2013. *Geophysical Research Letters*. 40 (16): 4194.
- Ferdowsi, B., M. Griffa, R. A. Guyer, P. A. Johnson, C. Marone, and J. Carmeliet. 3D Discrete Element Modeling of triggered slip in sheared granular media. 2014. *Physical Review E*. 89: 042204(1).
- Ferdowsi, B., M. Griffa, R. Guyer, P. Johnson, C. Marone, and J. Carmeliet. Experimental and numerical investigation of slip triggering in sheared granular layer as an analogue to dynamic earthquake triggering. *Physical Review Letters*.
- Ferdowsi, B., M. Griffa, R. Guyer, P. Johnson, and J. Carmeliet. Effect of boundary vibration on the frictional behavior of a dense sheared granular layer, . 2014. *Acta Mechanica*. 225: 2227.
- Geller, D., R. Ecke, K. Dahmen, and S. Backhaus. Brittle and

- non-brittle events in a continuum-granular earthquake experiment. To appear in *Physical Review Letters*.
- Gomberg, J.. Permanently enhanced dynamic triggering probabilities as evidenced by two $M > 7.5$ earthquakes. 2013. *Geophysical Research Letters*. 40: L50933.
- Gong, X., Q. Chen, Z. Peng, W. Wang, C. Wu, and J. Wu. Remotely triggered seismicity around the Fangshan Pluton near Beijing following the 2010 Mw 8.8 Chile earthquake. 2013. *Chinese Journal of Geophysics*. 57: 115.
- Griffa, M., B. Ferdowsi, E. Daub, R. Guyer, P. A. Johnson, C. Marone, and J. Carmeliet. Meso-mechanical analysis of deformation characteristics for dynamically triggered slip in granular materials. 2012. *Philosophical Magazine*. : 1.
- Griffa, M., B. Ferdowsi, R. A. Guyer, E. G. Daub, P. A. Johnson, C. Marone, and J. Carmeliet. Influence of vibration amplitude on dynamic triggering of slip in sheared granular layers. 2013. *PHYSICAL REVIEW E*. 87 (1): -.
- Griffa, M., E. G. Daub, R. A. Guyer, P. A. Johnson, C. Marone, and J. Carmeliet. Vibration-induced slip in Sheared Granular Layers and the Micromechanics of Dynamic Earthquake Triggering. 2011. *Europhysics Letters*. 96 (1): 14001 (6 pp.).
- Johnson, P.. Nonlinear acoustic/seismic waves in earthquake processes. 2012. In *Nonlinear Acoustics State-of-the-art and Perspectives: 19th International Symposium on Nonlinear Acoustics ; 21-24 May 2012 ; Tokyo, Japan*. Vol. 1474, p. 39.
- Johnson, P. A., B. Carpenter, M. Knuth, B. M. Kaproth, P. -Y. Le Bas, E. G. Daub, and C. Marone. Nonlinear dynamical triggering of slow slip on simulated earthquake faults with implications to Earth. 2012. *JOURNAL OF GEOPHYSICAL RESEARCH-SOLID EARTH*. 117: B04310.
- Johnson, P. A., B. Ferdowski, B. Kaproth, M. Scuderi, M. Griffa, J. Carmeliet, R. A. Guyer, P. Y. L. Bas, D. T. Trugman, and C. Marone. Acoustic emission and microslip precursors to stick-slip failure in sheared granular material. 2013. *Geophysical Research Letters*. 40: doi:10.1002/2013GL057848.
- Miller, P. W., and E. Ben-Naim. Scaling exponent for incremental records. 2013. *Journal of Statistical Mechanics*. P10025: 1.
- Olson-Reichhardt, C., L. Lopitina, X. Jia, and P. Johnson. Softening of granular packings with dynamic forcing. *Physical Review E*.
- Scuderi, M., B. Carpenter, P. Johnson, and C. Marone. Poro-mechanics of stick-slip frictional sliding and strength recovery on tectonic faults. To appear in *Journal of Geophysical Research*.
- Trugman, D. T., E. G. Daub, R. A. Guyer, and P. A. Johnson. Modeling dynamic triggering of tectonic tremor using a brittle-ductile friction model. 2013. *Geophysical Research Letters*. 40: L50981.
- Trugman, D., C. Wu, R. Guyer, and P. Johnson. Synchronous low frequency earthquakes and the elastic nature of the deep San Andreas Fault. *Earth and Planetary Science Letters*.
- Wu, C. Q., D. R. Shelly, J. Gomberg, Z. G. Peng, and P. Johnson. Long-term changes of earthquake inter-event times and low-frequency earthquake recurrence in central California. 2013. *EARTH AND PLANETARY SCIENCE LETTERS*. 368: 144.
- Wu, C., J. Gomberg, E. Ben-Naim, and P. Johnson. Testing delayed triggering of repeating earthquakes in central California. 2014. *Geophysical Research Letters*. 41: doi:10.1002/2013GL059051.
- Wu, C., J. Gomberg, E. Ben-Naim, and P. Johnson. Triggering of repeating earthquakes in central California. 2014. *Geophysical Research Letters*. 41: 1499.
- Wu, C., X. Meng, Z. Peng, and Y. Ben-Zion. Lack of spatio-temporal localization of foreshocks before the 1999 Mw 7.1 Duzce, Turkey earthquake. 2014. *Bulletin of the Seismological Society of America*. 104: doi:10.1785/0120130140.
- Wu, J., Z. G. Peng, W. J. Wang, X. Gong, Q. F. Chen, and C. Q. Wu. Comparisons of dynamic triggering near Beijing, China following recent large earthquakes in Sumatra. 2012. *GEOPHYSICAL RESEARCH LETTERS*. 39: -.

IMPACT: Integrated Modeling of Perturbations in Atmospheres for Conjunction Tracking - A New Orbital Dynamics and Drag Model to Avoid Collisions in Space

Alexei V. Klimenko
20120036DR

Abstract

The United States relies heavily on its space infrastructure for a vast number of applications, including communication, navigation, banking, national security, and research. However, NASA predicts that between now and 2030 orbital collisions will become increasingly frequent and could reach a runaway environment. This devastating scenario, also known as the Kessler Syndrome, has the potential to eventually destroy our assets in near-Earth space and result in a debris cloud that could make space itself inaccessible. Preventing the Kessler Syndrome requires, in addition to an object removal technique, a groundbreaking new orbital dynamics framework that combines a comprehensive physics-based model of atmospheric drag with an accurate uncertainty quantification of orbital predictions. The IMPACT project (Integrated Modeling of Perturbations in Atmospheres for Conjunction Tracking) developed such an integrated system of atmospheric drag modeling, orbit propagation, and conjunction analysis with detailed uncertainty quantification to address the space debris and collision avoidance problem.

Background and Research Objectives

Currently used orbital propagators, or forecast models, are based on general perturbation theory and include periodic and secular variations due to Earth's oblateness, gravitational resonance effects, solar radiation pressure, ocean tides, and atmospheric drag. The atmospheric drag is based on empirical neutral density models with simple parametric dependence on solar irradiance and geomagnetic indices. These empirical models are finely tuned but are evidently insufficient in describing the full density and drag variations along an orbit, resulting in large uncertainties of orbital parameters. Aerodynamic lift and torque are usually neglected as well.

Current orbital propagation methods using these empirical models give rise to position uncertainties in the range of hundreds of meters to kilometers. In particular

for LEO (Low Earth Orbit) objects, satellite drag due to atmospheric friction is the major non-conservative force that can lead to significant errors. The neutral air density from 200 – 1000 km altitude can change by 80% during day and night and changes up to three orders of magnitude during high solar activity and during geomagnetic storms. Other significant periodic variations are correlated to the time of the year and the 27-day rotation of the sun and the 11-year solar sunspot cycle. In particular, strong geomagnetic storms lead to extreme, but short-lived density increases by 2-3 orders of magnitudes in just a few hours.

Space weather effects on the upper atmosphere are some of the largest contributors to density variations affecting orbital pathways. However, the basic approach to modeling these properties has changed little since the development of the first models by Jacchia in the 1960s

Heating in the thermosphere (100 – 800 km altitude) occurs in response to several mechanisms: (1) solar radiation absorption in EUV bands, (2) Joule heating at high latitudes, (3) auroral particle precipitation at high latitudes, (4) ocean tides, planetary, and gravity waves forcing from the lower atmosphere. Joule heating and auroral particle precipitation increases especially during geomagnetic disturbances in the inner magnetosphere. The inner magnetosphere, with altitudes from 12,000 – 42,000 km (2 – 6.6 Earth radii), is the major domain for radiation belts, rings currents, geomagnetic storms and substorms and are being intensively studied by the DREAM (Dynamic Radiation Environment Assimilation Model) project – a previously funded and highly successful LDRD-DR. In reality, these processes are coupled to the upper atmosphere and we did, for the first time, develop a framework for quantitatively describing and incorporating these effects into a new atmospheric dynamics and drag model, thus closing the gap between upper atmosphere and the inner magnetosphere.

In addition to deficiencies in the orbital propagator, the associated uncertainties of space objects are inaccurately described with the first (mean) and second (covariance) moment only. However, forecasting the position and velocity of an object at a future time should be associated with a probability density function (PDF). Currently the standard methods for propagation the PDF are typically an extended Kalman filter (eKF) or unscented Kalman filter (uKF), which make use of only the first two moments, thereby limiting their ability to accurately describe the actual PDF. In addition, collision probabilities are only based on uncertainties modeled by the first two moments as well. The collision probability changes significantly by properly modeling the non-Gaussian PDF.

Scientific Approach and Accomplishments

Ground-based Observations

Satellite observations are important to both validate IMPACT predictions and provide regular inputs to IMPACT-developed techniques like Satellite Orbit Tomography (SOT) and Light Curve Inversion (see below).

LANL is using a Raven-class telescope (0.35 m aperture C14 on a Paramount ME mount) to track satellites. This observational facility is located at 2650 m altitude under dark skies about an hour from Los Alamos, NM. The upgrade of the facility under IMPACT to allow remote operations now allows systematic observations and rapid response to unanticipated events with much reduced time and effort. We typically take several nights of observation around each New Moon, weather and wildfire permitting. This provides repeated and regular observation of target satellites with good metric accuracy for orbit determination and light curves for object characterization. The objects we have been observing for IMPACT are primarily:

- Satellites with accurately known orbits, which we use to characterize the accuracy of our metric determinations. These satellites include the GPS and WAAS constellations, geodesy satellites, and satellites carrying on-board GPS receivers. These data confirmed that we are typically achieving a few arcsec metric accuracy.
- Cubesats, many of which are similar in terms of mass, volume, shape, and surface materials and hence are good test particles for looking at atmosphere-induced variation in drag. We also observe other LEO satellites that have size/shape/mass information available. Metric observations are used to compare to predicted values to validate atmospheric models.
- Objects in highly eccentric orbits that dip into the atmosphere at perigee. The atmosphere at the geographic location and altitude of the perigee pass

dominates the drag perturbation over an orbit for one of these objects. Rocket bodies in GTO are numerous and particularly useful, since they tend to have known physical characteristics. We produce light-curves from our observations as inputs to IMPACT-developed light curve inversion techniques. The derived shapes and spin-states of the objects in turn affect the average frontal area around the time of perigee.

We have also observed debris from satellite collisions and the Breeze-M explosion. In observed breakup debris, we are finding rotation periods up to 7 rev/s (420 rpm), a challenge for many observing systems.

A major emphasis for IMPACT was analysis of the June 22, 2013 close approach of LANL's FORTE satellite with a non-functioning Russian Meteor satellite. This was an extraordinarily close approach – the final best estimate from the USAF Joint Space Operations Center (JSpOC) was 4.5m! We took observations both immediately before and soon after closest approach. Difficulties with clouds caused problems with analysis, but the observations placed upper bound on any possible delta V. Comparison of rotation periods confirmed that a collision had not taken place (even an extremely glancing collision with the very long FORTE antenna, for example).

Overall observations under IMPACT include over 300 different resident space objects (RSOs), including 26 GPS satellites and 76 rocket bodies.

By the end of the IMPACT project, the analysis pipeline had been working well for slower-moving objects in higher orbits, but the improvements necessary to deal with the more challenging fast-moving objects in LEO that are subject to significant drag were just beginning to be available. The observational program was just reaching the point of being able to generate large quantities of data suitable as inputs to the orbit assimilation block of the IMPACT framework (using the SOT technique) and to light curve inversion for satellite shape and spin state.

Uncertainty Quantification

Our goal is to compute collision probabilities that account for uncertainty at each stage of our modeling procedure. To be accurate, a collision probability must necessarily incorporate uncertainty from observations, density modeling and forecasting, drag estimation, and other sources. In order to combine uncertainty across these sources, we favor Monte Carlo-based methods.

The recent FORTE/Meteor close approach provided an opportunity to test a basic Monte Carlo strategy. First, we sampled ten GITM densities from the distribution of

possible densities. Next, we sampled 100 satellite state vectors from the distribution induced by observations of the two satellites made before the close approach. These state vector samples were randomly paired with a sampled GITM density and the pair was propagated to close approach. At the time of close approach, we approximated the distribution of the positions with a simple Gaussian and used this to calculate the probability of collision. This method required relatively few simulations and incorporated two important sources of uncertainty. More uncertainty sources could be incorporated very easily (we calculated a best fit drag coefficient, but weren't able to compute uncertainty at the time), although this would likely require a larger set of simulations. Figure 1 (left) shows a fit based on a similar simulated close approach.

We have also developed an importance sampling methodology for computing collision probabilities with reduced simulation costs. Importance sampling is a Monte Carlo method that draws a biased sample that is weighted to produce the correct expectations. Particularly in the case of small probabilities, this technique can be used to reduce the variance of an estimate, and therefore the number of samples required. We developed a two-stage procedure. In the first stage a raw Monte Carlo sample is drawn from all of the uncertainty sources. The results of this stage are analyzed to find regions of the original distribution that produce close approaches and the second stage samples directly from these regions. Figure 1 (right) shows the results of the methodology applied to the simulations shown in figures on the left and middle. The second stage used 100 simulations to accurately estimate the collision probability when compared with a brute force simulation.

Physics-based Density Forecast Modeling

A key element in improving satellite orbital predictions is the correct specification of the ionosphere-thermosphere environment, given that atmospheric density exerts significant drag over satellites. There are a number of models that can estimate the composition and density of the ionosphere-thermosphere, from empirical models to physics based models. Empirical models, such as the Mass Spectrometer and Incoherent Scatter (MSIS) model, can provide an accurate estimation of current or past ionosphere-thermosphere density, based on a number of observations. Unfortunately, these types of models do not have predictive capabilities, that is, they provide a good nowcast but are often not suitable for a forecast. The IMPACT project uses a physics-based model, which has the potential to estimate a forecast of the ionosphere-thermosphere since they include the relevant physical behavior of the system. In particular, the project uses the Global Ionosphere-Thermosphere Model (GITM), developed by Aaron Ridley at

the University of Michigan, and openly available at: <http://herot.engin.umich.edu/~ridley/data/GITM/> Nevertheless, the IMPACT framework is able to switch between different models for comparative studies.

GITM is a physics-based three-dimensional model that solves the full Navier-Stokes equations for density, velocity, and temperature for a number of neutral and charged components. To account for solar activity, GITM uses at the moment the F10.7 solar flux, which solar radio flux at 10.7 cm wavelength measuring the noise level generated by the Sun at the Earth's orbit, hemispheric power index (HPI), which is derived from the 3-hour Kp, interplanetary magnetic field (IMF) data and solar wind velocity. GITM inherently allows for non-hydrostatic solutions to develop which allows for realistic dynamics in the auroral zones. As with many of the physics-based models, GITM includes a number of assumptions and physical representation of the ionosphere-thermosphere that might not be accurate and introduce errors into the estimation of the density. This severely affects the quality of a density forecast. The main parameter of interest is F10.7, used as a proxy in GITM for solar activity. Through experiments it was discovered that the F10.7 exerts a global influence upon the total density, which lead to the discovery that there is a direct linear correlation between the total density and F10.7 flux.

In order to improve the predictability of GITM, and provide a good forecast of the ionosphere-thermosphere, we implement a data assimilation system based on the ensemble Kalman filter (EnKF). The EnKF uses an ensemble of model simulations to approximate the probability distribution of the model, as well as the covariance matrix. The main advantages of the EnKF are the ease of implementation and the computational efficiency for non-linear models. In particular we use the localized ensemble transform Kalman filter (LETKF), which is a localized version of the EnKF. The LETKF assimilates by local volume centered at each grid-point variable, where the area of the local volume depends on model dynamics and assumptions of correlations between model variables. Given the local nature of the LETKF, the algorithm is highly parallel since all grid-point variables can be assimilated simultaneously.

For our particular problem, the GITM state variables and F10.7 are both estimated using the EnKF. Specifically, since F10.7 is a measured quantity, the EnKF assimilation will estimate a correction to the parameter. The correction of F10.7 is to estimate the appropriate coupling between the observed F10.7 and the model, that reduces the forecast error. For a given observed F10.7 index (PoF10.7), the model F10.7 parameter (PmF10.7) is given by

$$PmF10.7 = PoF10.7 + \delta PF10.7$$

Where the $\delta F_{10.7}$ is the “correction” to the F10.7 model input parameter.

The assimilation experiments use derived total neutral density of GPS measurements from Challenging Minisatellite Payload (CHAMP). The CHAMP satellite contain very accurate accelerometers and GPS instruments, which can be used to infer drag and therefore provide an estimate of the total neutral density along the satellite track. Given that we found a direct linear correlation between the F10.7 parameter and total density, it is possible to estimate the “correction” of the F10.7 parameter for the GITM model through the assimilation of CHAMP total density observations.

Figures 2 and 3 shows the daily averaged measured F10.7 value (red line), the ensemble average of the estimated F10.7 (blue line) using data assimilation with CHAMP data, as well as the ensemble standard deviation of F10.7. All index values are valid for October 21-31 2002. The estimated F10.7 value (blue line) is oscillating in accordance with the day-night position of the CHAMP satellite, indicating that the assimilation is correcting an overestimation/underestimation, suffered by the GITM model, through the F10.7 index. The left plot shows the ensemble average neutral density estimation for October 21 2002 at 0800 hours UTC.

The assimilation results indicate that using data assimilation can reduce the forecast error of the model. Furthermore, the model bias can be corrected through the calibration of key model parameters through data assimilation. We are currently seeking further funding opportunities, which include NASA, DOE, and LDRD, to continue the work on enhancing the predictability of the ionosphere-thermosphere. The future research directions include exploring other key parameters that influence other fields and properties of the model, such as temperature, composition, etc., for calibration in the data assimilation. Initial condition and boundary conditions are also a concern for the model simulation, and will be addressed in the assimilation scheme as well.

Drag Coefficient Modeling

We have developed closed-form solutions for simple convex geometries such as a sphere and flat plate for use with the Cercignani-Lampis-Lord (CLL) Gas Surface Interaction (GSI) model. Closed-form solutions were developed by fitting analytic expressions (modified from the original Schaaf and Chambre solutions) to Direct Simulation Monte Carlo (DSMC) simulations using NASA’s DSMC Analysis Code (DAC) that were sampled from the global parameter space using Latin Hypercube sampling. These CLL closed-form drag coefficient solutions fit the DAC drag coefficient simulations within $\sim 0.5\%$ over the global parameter space

(e.g. the maximum error in the modified closed-form solutions was $\sim 0.5\%$).

More recently, we developed a response surface model (RSM) technique for drag coefficient modeling. The method was validated for a sphere and then extended to the more realistic cases of the GRACE satellite, the CHAMP satellite, and the International Space Station (ISS). Comparison of the original TPMC training simulations and the RSM predictions show errors of $\sim 0.25\%$ for the sphere and $\sim 0.7\%$ for GRACE, $\sim 0.7\%$ for CHAMP, and $\sim 1.0\%$ for the ISS. We compared in Langmuir, Temkin, and Freundlich adsorption models and showed that the Temkin and Freundlich models match fitted drag coefficients better at both low and high altitudes. Furthermore, both adsorption models alleviate some of the physical deficiencies present in the Langmuir model, such as constant adsorption energy and monolayer adsorption.

The RSM models for CHAMP and GRACE have been validated by comparison of propagated positions using the RSM drag coefficients with GPS positions. The RSM drag coefficient model for GRACE was found to perform the best when compared with other literature models. Furthermore, the drag coefficient has been applied in an attempt to determine which atmospheric model closest represents reality by comparing GRACE and CHAMP propagated positions with GPS positions. The results for GRACE propagated through several different atmospheric models are shown in Figure 4.

The results show that data assimilation with GITM most closely represents the true state of the atmosphere during this time period (assuming the accuracy of the RSM). The High Accuracy Satellite Drag Model (HASDM) has the second smallest amount of error after 96 hours, followed by GITM without any data assimilation, and finally the Mass Spectrometer Incoherent Scatter (MSIS) model. The results of Figure 4 show that physics-based modeling of the atmosphere, in conjunction with accurate satellite drag coefficients, best reproduces the true trajectory of a satellite (GRACE for this case).

Finally, extensive sensitivity analyses have been performed to determine the most important drag physics that affect the uncertainties in satellite trajectories. Satellites were propagated at starting altitudes of 300 km and 600 km and the differences between specific drag physics cases were compared by computing the absolute magnitude of the position difference after 24 hours (see Figure 5).

Figure 5 shows that the largest source of uncertainty at 300 km altitude is due to zero shape knowledge (e.g. an arbitrarily shaped piece of space debris). This a realistic case

for LEO space debris where there is often no knowledge of the debris shape. The second largest differences at 300 km altitude come from the difference between zero accommodation coefficient and the appropriate adsorption model using a Temkin adsorption model. Although the errors are large, accommodation coefficients are known to be close to unity at low altitudes, and therefore, the 20.5 km difference in position is unlikely. Instead, the 510 meters between unity and the adsorption model is a more realistic situation. Finally, geomagnetic conditions are the third largest source of uncertainty. Only recently have satellites observing the Sun been able to give a small amount of warning of oncoming geomagnetic storms. The large errors due to the lack of shape knowledge of space debris can be combated by using light curve estimation for the shape and orientation of LEO space debris.

Accurate tracking of Resident Space Objects (RSOs) requires improved knowledge of the non-conservative forces acting on the RSOs. These forces are strongly dependent on the shape, surface properties, and rotational states of the RSOs, which are not known in general. However, light curve or non-resolved imaging data is sensitive to these properties and is readily available with optical measurements. Therefore, near a real-time framework SSA framework should use light curve measurements to both improve non-conservative forces model and to also provide features. These features can be used in high-level reasoning approaches to perform feature-aided tracking, classification, anomaly detection, and determination of intent. As part of IMPACT we have developed light curve inversion techniques that estimate characteristics such as shape, attitude and spin state, surface properties, and mass. In particular, along with improve atmospheric models we have used light curve measurements to estimate Cd parameter as a function of orientation.

Atmospheric Density Reconstruction

The ground-based tracking observations are used to estimate the orbital state and drag ballistic coefficient of a number of satellites. By analyzing the change in the satellites' orbits over time, one can estimate the atmospheric neutral density, in the form of corrections to an assumed density model. This approach is often called a Dynamic Calibration of the Atmosphere (DCA) in the literature. This "nowcast" density estimate can then be fed into the data assimilation described above to provide better physics-based density forecasts.

We have developed a new DCA method called Satellite Orbit Tomography (SOT), which was originally inspired by X-ray computed tomography. Compared to the methods currently in operational use by the US Air Force (USAF), the SOT allows an estimate of equivalent accuracy (10%) to be

made with a sparse data set of as few as 40 objects, observed nightly from the same site. In contrast, the density estimation used by USAF, relies on a subset of thousands of objects tracked by the Space Fence from multiple sites around the world. Here, rather than using the decay in X-ray intensity, we use the decay in orbital specific mechanical energy (ξ). The method is outlined as follows:

- Identify a set of target satellites for tracking, nominally those that are inactive (e.g. debris, rocket bodies). Track each target over a span of time (>days) to build up estimates of the position, velocity, and drag ballistic coefficient (β). In the simulations considered to date, we have used a Constrained Admissible Region Multiple Hypothesis Filter (CAR-MHF) to estimate these states based on measured angles and angle-rates.
- Remove bias in the estimated β introduced by global errors in the assumed density model used in the CAR-MHF. This is done by including at least some tracking targets that have fairly well-modeled β , and comparing their modeled β with that estimated by the CAR-MHF. This approach also leverages the drag coefficient modeling described above: given the published information on a satellite's shape and mass, we are able to sufficiently model β .
- Using a given satellite's estimated position and velocity at one time (t_1), and then again at a later time (t_2), calculate the decay in ξ using the osculating orbit states at those times. The time span $\Delta t = t_2 - t_1$ should be long enough to observe the decay signal above the measurement noise, yet short enough to recover some time-resolved information in the density model. Our simulations have used Δt of 48 hours, but a lower limit of 24 hours is feasible given the expected accuracy of our ground-based tracking system and the likely revisit rate (~ 1 to 2 passes per night) for our mostly LEO targets.
- Using the measured decay in ξ from the set of targets, solve for a spatially-resolved scalar correction (s) to the assumed density model. The correction factor s is defined in a grid; we have used grids spanning 300 to 500 km altitude, with 100 km altitude spacing and 20 deg spacing in latitude and longitude. In general, the problem is underdetermined (there are more grid elements than target satellites) and ill-posed (most satellites do not pass through each grid element). Thus, we use Tikhonov regularization to stabilize the solution, with a spatial smoothness constraint on the solved-for s field.

Our most recent simulations use actual resident space objects from the publically available catalog, and assume a

single ground site at Fenton Hill, NM. Using only 40 targets and having suitable visibilities from this single ground site, we are able to reconstruct the time-averaged, yet spatially resolved, density field over 48 hours to within approximately 10%. These results also assume reasonable orbit estimation errors, and that each satellite's assumed ballistic coefficient β will have zero-mean error with 1- σ standard deviation of 10%. The satellite orbit tomography approach has some practical advantages over typical weighted least-squares approaches, such as allowing easy density model specification i.e. not requiring Jacobian matrices that describe the sensitivity of the density model dynamics to the states.

Impact on National Missions

Space Situational Awareness (SSA) is one of the core missions of Los Alamos as outlined in the Strategic Investment Plan. SSA is essential to ensuring stability in space and sustainability of our space activities and we will directly address this particular need with rigorous science and innovative technology. Our results have evolved SSA from today's forensic operational mode to a predictive mode and transform it so that we receive advanced warnings of possible collisions instead of being forced to investigate the cause in the aftermath (see Iridium-Cosmos collision). Specifically, our project advanced the ability to monitor and track space objects by creating a new atmospheric drag model. The framework developed by this projects, allows to provide accurate collision probabilities for avoidance maneuvers and gives the ability to track space objects during geomagnetic storms as well as better satellite lifetime and reentry estimates. Our project has lead to a highly visible joint endeavor across several divisions and broadened our SSA portfolio. It has lead to new collaborations and built a new space flight dynamics research community at Los Alamos National Lab that is at the forefront of the field.

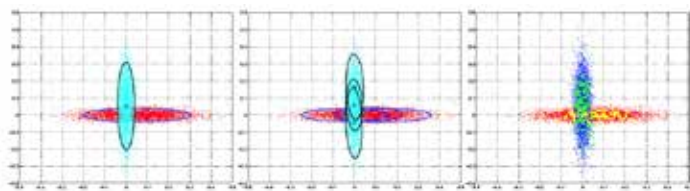

Figure 1. (left) Gaussian approximations to Monte Carlo samples for a simulated example. (middle) Mixture of Gaussian approximation to Monte Carlo sample from a simulated example. (right) The yellow and green points show 100 importance sampled points using the two-stage procedure. This small sample produced a very accurate estimate of the probability when compared to a brute force simulation of 9,000,000 pairs.

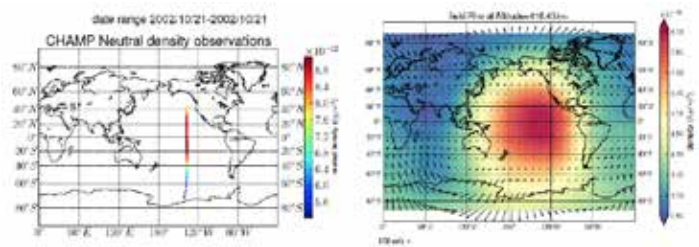

Figure 2. Example of data assimilation: (left) CHAMP observations over a 30 minute assimilation window; (right) assimilated state after combining CHAMP observations with GITM forecast.

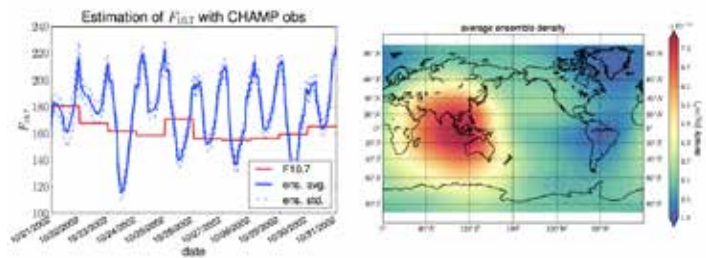

Figure 3. Left plot: daily averaged measured F10.7 (red line), ensemble average F10.7 from the assimilation of CHAMP neutral density observations (blue line) and ensemble standard deviation for F10.7 (blue dashed line). The oscillations in the estimated F10.7 seem to follow the day-night change seen by the CHAMP satellite. Right plot: ensemble average density field for October 21 2002 at 0800 hours UTC.

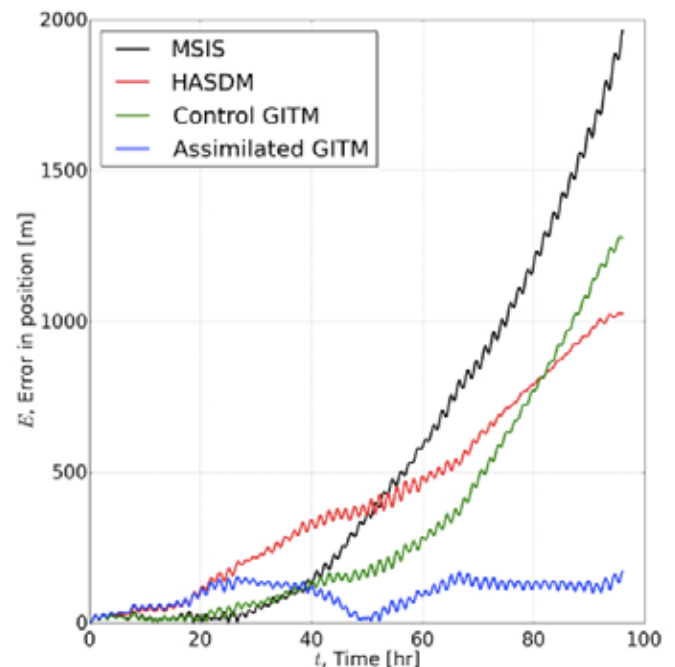

Figure 4. GRACE's orbit propagated through four different atmospheric models (MSIS, HASDM, Control GITM, and Assimilated GITM) compared with GPS data to compute position error over 96 hours. The propagation is performed starting 00:00:00 UTC on Aug. 28, 2009.

Source of Potential Error	Comparison	Error at 300 km	Error at 600 km
Atmospheric Model	MSIS vs. GITM	4.3 km	40 m
Solar Conditions	10 sfu difference	3.2 km	97 m
Geomagnetic Conditions	Nominal vs. Stormy	16.4 km	235 m
Zero Shape Knowledge	Sphere vs GRACE	23.6 km	143 m
Partial Shape Knowledge	Sphere vs. Cube	3.6 km	55 m
Accommodation Coefficient	Zero vs. Ads. Model	20.5 km	20 m
Accommodation Coefficient	Unity vs. Ads. Model	510 m	73 m

Figure 5. Satellite trajectory sensitivities to important drag physics at 300 km and 600 km over a propagation time period of 24 hours. Satellites use $\beta = 0.001$ and a spherical geometry unless otherwise stated.

Publications

Godinez, H. C., B. Nadiga, A. Ridley, J. Koller, E. Lawrence, and D. Higdon. Atmospheric Density Specification with the Global Ionosphere-Thermosphere Model (GITM) using the Ensemble Kalman Filter. 2012. : 2012.

Godinez, H. C., J. Koller, and A. J. Ridley. Ensemble Data Assimilation for the Global Ionosphere-Thermosphere Model (GITM). 2013. J. Geophys. Res.. : in preparation.

Kelecyc, T., M. Shoemaker, and M. Jah. Application of the Constrained Admissible Region Multiple Hypothesis Filter (CAR-MHF) to Initial Orbit Determination (IOD) of a Break-up. Presented at 6th European Conference on Space Debris. (Darmstadt, Germany, April 2013).

Klimenko, A., D. Palmer, D. Thompson, R. Linares, and E. Rabin. SSA Data Analysis Framework 1 Introduction 2 Fenton Hill Observatory Setup Overview 3 Input Data 4 Telescope Pointing. 2013. LANL Reports LACP-13-00008.

Lawrence, E., and D. Higdon. An Importance Sampling Method for Computing Collision Probabilities. 2013. Journal of Spacecraft and Rockets. : in preparation.

Linares, R.. Angles-Only Orbit Determination For Electro-Optical Sensors. 2012. SWX Reports.

Linares, R., J. L. Crassidis, C. Wetterer, K. A. Hill, and M. K. Jah. Astrometric and Photometric Data Fusion for Mass and Surface Material Estimation using Refined Bidirectional Reflectance Distribution Functions-Solar Radiation Pressure Model. 2013. In Air Force Maui Optical and Supercomputing Site Conference. (Maui, HI, September 2013). , p. 121. KIHEI HI: PACIFIC DEFENSE

SOLUTIONS LLC.

Linares, R., M. Shoemaker, A. Walker, P. Mehta, D. Palmer, D. Thompson, J. Koller, and J. L. Crassidis. Photometric Data from Non-Resolved Objects for Space Object Characterization and Improved Atmospheric Modeling. 2013. In Air Force Maui Optical and Supercomputing Site . (Maui, HI, Sept 2013). , p. 31. Maui: Amos Conference.

Linares, R., and J. L. Crassidis. Sigma Point Transformation for Gaussian Mixture Distributions Applied to Attitude Estimation. 2013. AIAA/AAS Space Flight Mechanics Conference.

Mehta, P. M., A. Walker, C. A. Mclaughlin, and J. Koller. Comparing Physical Drag Coefficients Computed with Direct Simulation Monte Carlo Using Different Gas-Surface Interaction Models. 2013. Journal of Spacecraft and Rockets. : submitted.

Mehta, P. M., and C. A. Mclaughlin. GRACE Drag Coefficient Model Developed using Direct Simulation Monte Carlo (DSMC) Method. 2013. AIAA/AAS Space Flight Mechanics Conference.

Mehta, P. M., and C. A. Mclaughlin. Drag Coefficient Modeling for GRACE using Direct Simulation Monte Carlo Drag Coefficient. 2013. AIAA/AAS Space Flight Mechanics Conference.

Mehta, P. M., and M. Shoemaker. Satellite Drag Coefficient Modeling. 2012. SWX Reports.

Mehta, P., and C. Mclaughlin. Drag Coefficient Modeling for GRACE using Direct Simulation Monte Carlo. 2013.

Advances in Space Research. 148: 1281.

Shoemaker, M. A., B. Wohlberg, and J. Koller. Atmospheric Density Reconstruction using Satellite Orbit Tomography. 2014. Journal of Spacecraft and Rockets. : submitted.

Shoemaker, M. A., B. Wohlberg, and J. Koller. Atmospheric Density Reconstruction Using Tomography of Satellite Orbits. 2013. AAS/AIAA Space Flight Mechanics Meeting.

Walker, A.. Drag coefficients computed by the Direct Simulation Monte Carlo method. 2013. LANL Reports.

Walker, A., P. Mehta, and J. Koller. A Quasi-specular Drag Coefficient Model using the Cercignani-Lampis-Lord Gas-Surface Interaction Model. 2014. Journal of Spacecraft and Rockets. : 1.

Walker, A., P. Mehta, and J. Koller. Different Implementations of Diffuse Reflection with Incomplete Accommodation for Drag Coefficient Modeling. 2014. Journal of Spacecraft and Rockets. : 1.

Wetterer, C. J., R. Linares, J. Crassidis, T. Kelecy, M. Ziebart, P. Cefola, and M. Jah. Distribution Functions. 2013. AIAA/AAS Space Flight Mechanics Conference.

Predicting Climate Impacts and Feedbacks in the Terrestrial Arctic

Scott Painter
20120068DR

Abstract

The project focused on improving capability to model response of permafrost to a warming climate. A highly parallel terrestrial Arctic modeling tool, the Arctic Terrestrial Simulator (ATS), was developed to simulate thermal, hydrological, and carbon cycle processes relevant to the Arctic tundra. The ATS integrates new models of freezing soil thermal hydrology and surface water dynamics with existing models of snow and surface energy balance, snow distribution, and organic matter decomposition, all in an extensible and flexibly configured framework. A novel multiphysics management framework called Arcos was developed to manage the couplings among the multiple process models. Arcos has significant potential to help manage complexity in next generation land surface and watershed models, and is currently being evaluated by multiple externally funded programs. ATS models of the Barrow Environmental Observatory were calibrated to borehole temperature data and used to project the response of Arctic tundra to warming climate. Results suggest significant expansion of the summer thaw layer by 2100, thus making previously frozen carbon available for decomposition and potential release to the atmosphere. Results also suggest that uncertainties in soil properties result in significant uncertainties in projected permafrost response. The same multi-physics realization used to simulate the Arctic can be used for a number of problems of national security interest.

Background and Research Objectives

The Arctic region has been a global carbon sink for thousands of years and currently contains about half the global belowground organic carbon [1]. The Arctic is now warming faster than the rest of the Earth (e.g. [2,3]) but the scientific community cannot say how much Arctic carbon will thaw, decompose into greenhouse gases (GHG), and be released to the atmosphere or how fast it will happen because current modeling tools do not adequately address the complex interactions among thermal, mechanical and hydrologic permafrost pro-

cesses that control GHG production and sequestration in a thawing and topographically complex landscape. In particular, current projections of permafrost thaw and carbon release use simplified representations of the thermal hydrology of freezing/thawing soil, do not explicitly model overland flow or lateral subsurface flow, and neglect the effects of topography on surface energy balance and hydrology. The overarching goal of this project was to provide reliable quantitative projections of permafrost response to a changing climate including the effects of microtopography and topographic reorganization on hydrologic response and GHG release. The project focused on critical new modeling capabilities and improved projections of soil moisture and temperature, which control GHG release from thawing soil, taking into account submeter-to-meter scale variations in topography.

Scientific Approach and Accomplishments

The Arctic Terrestrial Simulator (ATS) was developed to provide the required terrestrial Arctic process modeling capability. ATS leverages and greatly extends the existing LANL-developed highly parallel Amanzi code [4]. Amanzi provides a number of important features for the ATS, including a very general parallel unstructured mesh capability, advanced discretization toolsets for these meshes, and parallel output for modern visualization tools. Thermal, hydrological, geochemical, and vegetation processes relevant to the Arctic tundra models were developed and implemented in ATS. To manage the significant complexity associated with those coupled processes, a novel multiphysics management framework called Arcos [5] was developed (Figure 1). Arcos is based on a Multiprocessor Coordinator (MPC)/ Process Kernel (PK) architecture, within which a model for each individual ecohydrological process is implemented in a PK and MPCs are used to manage coupling among the PKs in a hierarchical framework. A second key feature of the Arcos framework is a directed acyclic graph that is formed at runtime to manage intermediate variables

that are shared among multiple PKs. The Arcos framework has significant potential beyond Arctic simulations, and is now being evaluated for land surface and ecohydrological simulations in externally funded programs focused on tropical, temperate, and Arctic regions.

A new constitutive model [6] for water partitioning between ice and liquid phases in unsaturated frozen soils was developed and successfully compared to existing laboratory data. The new constitutive model forms the basis of a new thermal hydrology model [7] for freezing/thawing soil, a key component in our permafrost modeling capability. That model was successfully compared to existing data from laboratory experiments. Simulations of phase-change in freezing/thawing soil are numerically difficult because of significant nonlinearities in the constitutive models. Convergence and time step size were significantly improved by a new algorithm for initializing the iterative process at each time step.

The freezing soil model was combined with a snow and surface energy balance model and a new and computationally tractable model for overland flow and heat transfer with freezing of ponded water. That combination of processes resulted in a fully coupled permafrost thermal hydrology model. That model was successfully calibrated and compared to borehole temperature data (Figure 2).

Simulations to predict the future evolution of Arctic lowland tundra require high-resolution terrain-following computational grids. A computational workflow for generating such grids using available high-resolution digital elevation maps was developed and successfully demonstrated using data from the Barrow Environmental Observatory (BEO). The workflow includes an efficient multistep procedure for initializing and spinning up the simulations. A three-dimensional example showing the coupled thermal hydrological system after spinning up is shown in Figure 3.

Earth system model projections of future climate were used to drive projections of permafrost dynamics at the BEO. Preliminary results (Figure 4) suggest that the active layer, the upper part of the soil that thaws annually, will be significantly deeper by 2100, making more carbon available for decomposition and potential release. In addition, the soil is projected to be significantly drier. Low- and flat-centered polygons are projected to be wetter than high-centered polygons. Testing of that hypothesis will require the capability to represent dynamic topography. Significant progress was made on implementing the computational infrastructure required for representing dynamic topography, including a tractable algorithm for representing the effect and dynamic mesh infrastructure. However, additional work is required to further refine the dynamic topography

capability of ATS. That work is underway in an externally funded program.

Projections of future permafrost dynamics have significant uncertainty. Although uncertainty associated with the climate drivers have been addressed previously, the uncertainty associated with difficult-to-characterize soil properties had not been previously addressed. We used a calibration-constrained uncertainty analysis to produce 1000 samples of soil property combinations that are all consistent with exist calibration targets from field campaigns. Those soil property combinations were then used in forward projections driven by Earth system model runs. Results (Figure 5) indicate significant uncertainty in projected active layer thickness even for a specified future climate. A global sensitivity analysis for permafrost thawing simulations was conducted to help understand the relative importance of several physical parameters in controlling depth to permafrost [8]. The thermal conductivity, porosity and vegetation characteristics were determined to be the three most important factors contributing to the active layer depth.

Characterization of permafrost-dominated landscapes is crucial for understanding and predicting the spatial and temporal distribution of climate change related impacts and feedbacks in the Arctic. We developed and evaluated an automated approach to identify and characterize Arctic ice-wedge polygonal tundra landscape components, such as troughs, ponds, river- and lake-like objects, which constitute drainage networks, using high spatial resolution satellite imagery [9]. Identification and characterization of drainage network components is important for tracking Arctic tundra terrain evolution as well as for estimating water, heat and carbon fluxes for use in climate models.

Impact on National Missions

The project addressed a significant gap in the scientific community's capability to understand and predict impacts of climate change by providing a high latitude high-performance Arctic landscape modeling capability to complement existing ocean, sea ice, ice sheet and atmosphere models. In addition, the Arcos framework developed as part of this project provides new capability to manage complexity in land surface and ecohydrological models, which is expected to lead to better representations of watershed response to changing climate.

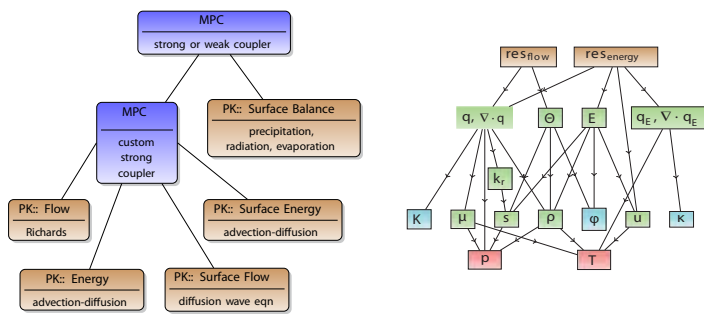

Figure 1. The Arcos process model management framework was developed to manage the significant complexity associated with process rich models of permafrost response to changing climate. Arcos uses a process kernel (PK) and multiprocess coordinator (MPC) architecture to couple various land surface and near-surface process representations in a dynamically configured simulation. It is based on a process tree (left) to hierarchically organize the various process models and a directed acyclic graph (right) to manage intermediate variables that are shared among the various process models. The example process tree on the left is for a coupled surface/subsurface thermal hydrology simulation, while the directed acyclic graph on the right is for a subsurface only freezing soil simulation.

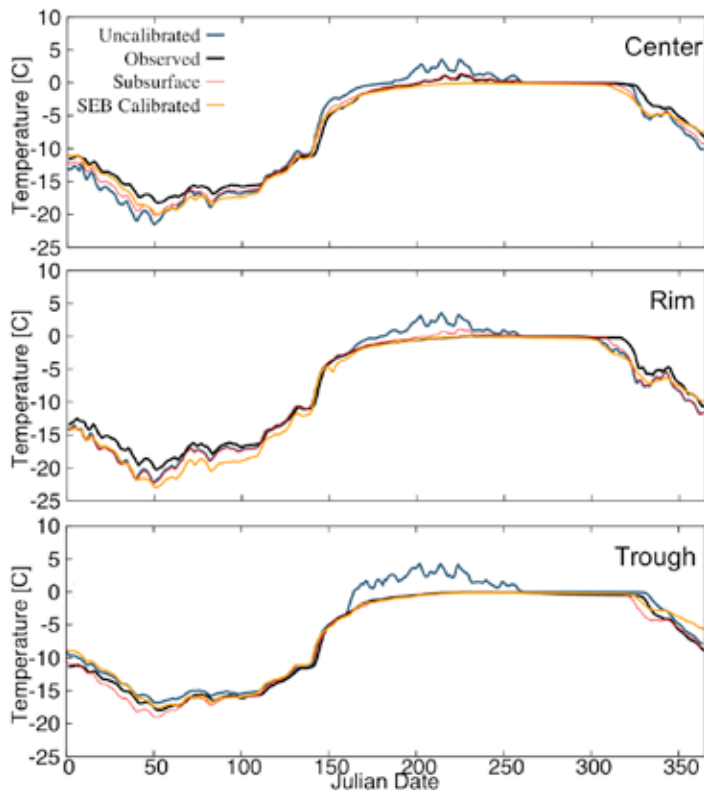

Figure 2. Thermal hydrology coupling surface and subsurface processes were successfully calibrated to borehole temperature data from the Barrow Environmental Observatory. Shown in each panel are temperatures at 40 cm depth for the year 2013 based on an uncalibrated model, a calibrated subsurface only model, a calibrated surface/subsurface model, and borehole measurements. The three panels are for different positions in a typical ice wedge polygon.

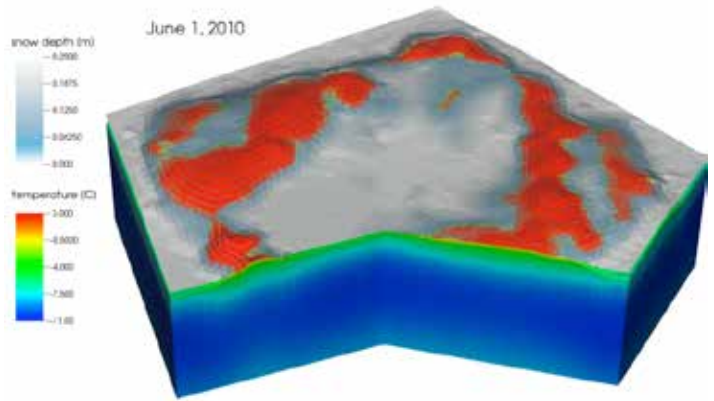

Figure 3. The ATS has been used in first-of-a-kind three-dimensional coupled surface/subsurface simulations of thermal hydrology in polygonal tundra. Shown are soil temperature and snow depth for a single ice wedge polygon at the Barrow Environmental Observatory. Ice wedge polygons are the basic geomorphic unit in polygonal tundra.

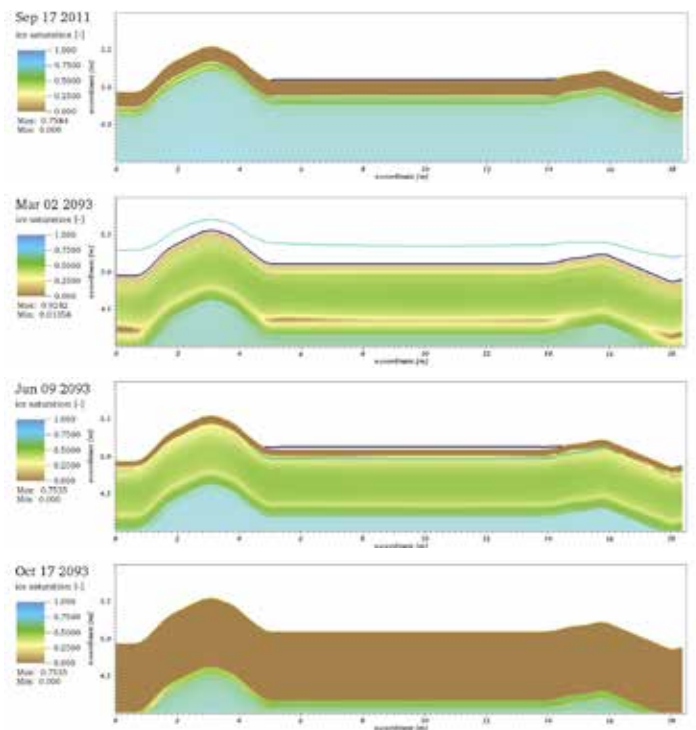

Figure 4. Existing Earth System Model (ESM) projections of future climate near Barrow Alaska were used to drive two-dimensional models of permafrost thermal hydrology. Shown are calculated ice saturation in cross-section across a low-center ice wedge polygon in 2011 and at three dates in year 2093. Snow height (black curve) and ponded water height (turquoise curve) above the topography are also shown. These simulations suggest that the active layer thickness, the thickness of the soil that thaws annually, will increase from about 30 cm in 2011 to 90 cm in 2093. These simulations were driven by ESM model outputs that assume a “business as usual” scenario for anthropogenic releases of greenhouse gases.

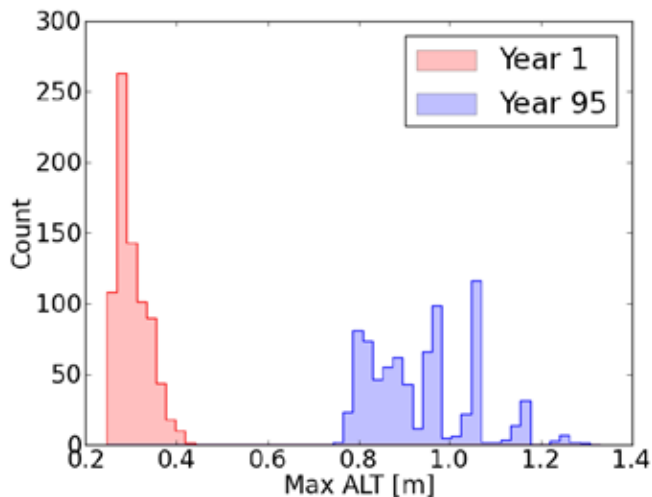

Figure 5. Parameter estimation using borehole temperature data was used to obtain soil thermal hydrology parameters applicable at the field scale. However, the estimated parameters are not without uncertainty, which results in significant uncertainty in projected active layer thickness. Shown are histograms of active layer thickness in year 2006 (labeled as Year 1) and 2100 (labeled as Year 95) at the Barrow Environmental Observatory based on 1000 realizations of soil parameters. The 1000 soil parameter combinations were obtained from a null space Monte Carlo algorithm, which generates samples that are each consistent with the calibration data. The active layer is projected to be significantly deeper by 2100, which will expose frozen carbon for microbial decomposition and potential release to the atmosphere. However, the projections are uncertain even for a specified future climate because of the uncertainty in soil parameters.

References

1. Moulton, J. D., M. W. Bukas, L. Pritchett-Sheats, M. Day, M. Berndt, R. Garimella, G. Hammond, and J. C. Meza. High-level design of Amanzi, the multi-process high performance computing simulator.
2. Blunden, J., and D. S. Arndt. State of the climate in 2012. 2013. Bulletin of the American Meteorological Society. : S1.
3. Turner, J., J. E. Overland, and J. E. Walsh. An Arctic and Antarctic perspective on recent climate change. 2007. International Journal on Climatology. : 277.
4. Hansen, J., R. Ruedy, J. Glascoe, and M. Sato. GISS analysis of surface temperature change. 1999. Journal of Geophysical Research. : 30997.
5. Coon, E. T., J. D. Moulton, and S. L. Painter. Managing complexity in simulations of land surface and near-surface processes. Environmental Modeling and Software.
6. Painter, S. L., and S. Karra. Constitutive model for

unfrozen water content in subfreezing unsaturated soils. 2014. Vadose Zone Journal. 13: doi:10.2136/vzj2013.04.0071.

7. Karra, S., S. L. Painter, and P. C. Lichtner. Three-phase numerical model for subsurface hydrology in permafrost-affected regions. To appear in The Cryosphere.
8. Godinez, H. C., C. Xu, B. Travis, C. Wilson, and S. Painter. Key parameters for permafrost thawing in a warming climate: A model based analysis. Journal of Geophysical Research.
9. Skurikhin, A. N., C. Gangodagamage, J. C. Rowland, and C. J. Wilson. Arctic tundra ice-wedge landscape characterization by active contours without edges and structural analysis using high-resolution satellite imagery. 2013. Remote Sensing Letters. 4: 1077.

Publications

- Coon, E., M. Berndt, J. D. Moulton, and S. Painter. The Arctic Terrestrial Simulator: Developing a flexible multi-physics simulator based on Amanzi. Presented at 2012 SIAM Annual Meeting . (Minneapolis, 9-13 July 2012).
- Frampton, A., G. Destouni, Y. Sjoberg, and S. Painter. Transient modeling of permafrost dynamics in changing climate scenarios. Presented at 2011 Institute of Electrical and Electronics Engineers 7th International Conference on E-Science. (Stockholm, Sweden, 5-8 December).
- Frampton, A., S. L. Painter, and G. Destouni. Permafrost degradation and subsurface-flow changes caused by surface warming trends. 2013. Hydrogeology Journal. 21 (1): 271.
- Frampton, A., S. L. Painter, and G. Destouni . Effects of hydrological inputs on the dynamics of permafrost system formation and degradation. Presented at European Geophysical Union General Assembly 2012. (Vienna, Austria , April 7-12, 2012).
- Frampton, A., S. Painter, S. W. Lyon, Y. Sjoberg, and G. Destouni. Transient modeling of permafrost dynamics in a changing climate. Presented at American Geophysical Union Fall Meeting. (San Francisco , 5-9 Dec. 2011).
- Godinez, H. C., C. Xu, B. Travis, C. Wilson, and S. Painter. Key parameters for permafrost thawing in a warming climate: A model based analysis. Journal of Geophysical Research.
- Karra, S., S. L. Painter, and P. C. Lichtner. Three-phase numerical model for subsurface hydrology in permafrost-affected regions (PFLOTRAN-ICE Version 1.0). To appear in The Cryosphere.

-
- Lara, M., A. McGuire, A. Euskirchen, S. Eugenie, C. Tweedie, K. Hinkel, A. Skurikhin, V. Romanovsky, G. Grosse, W. Boulton, and H. Genet. Polygonal tundra geomorphological change in response to warming alters future CO₂ and CH₄ flux on the Barrow Peninsula. To appear in *Global Change Biology*.
- Lewis, K. C., G. A. Zvoloski, B. Travis, C. Wilson, and J. Rowland. Drainage subsidence associated with Arctic permafrost degradation. 2012. *Journal of Geophysical Research-Earth Surface*. 117: -.
- Painter, S. L., J. D. Moulton, and C. J. Wilson. Modeling challenges for predicting hydrologic response to degrading permafrost. 2013. *Hydrogeology Journal*. 21 (1): 221.
- Painter, S. L., and Karra. Constitutive model for unfrozen water content in subfreezing unsaturated soils. 2014. *Vadose Zone Journal*. 13 (4): xx.
- Skurikhin, A. N., C. Gangodagamage, J. C. Rowland, and C. J. Wilson. Arctic tundra ice-wedge landscape characterization by active contours without edges and structural analysis using high-resolution satellite imagery. 2013. *Remote Sensing Letters*. 4 (11): 1077.

Complex Natural & Engineered Systems

Directed Research
Final Report

Elucidating Humankind's Evolving Environment: From the Earth's Core to the Cosmos

Harald O. Dogliani
20120166DR

Abstract

The Institute of Geophysics, Planetary Physics and Signatures sponsored 45 separate studies, which were the result of annual, competitive proposal solicitations. 110 scientific publications were produced. We include a sampling of the studies, as follows: (1) Astrophysics: supernova element production, star collapse and black hole formation, and HAWC gamma-ray experiments; (2) Space: A citizen-science aurora-borealis website, Terrestrial ring current, Saturn's magnetosphere, and Astroseismology; (3) Science of Signatures: Scientific applications for CubeSats; (4) Climate: Ice ridge parameterization for sea-ice modeling, Laboratory ice experiments to enhance glacier models, wintertime warming effects on Arctic vegetation, paleoclimate analysis to delineate anthropogenic and natural climate change, and Real-time Arctic methane isotope field observations for source attribution; and (4) Geophysics: Unified crustal models, Improved seismic analysis, Slip-induced earthquakes, Volcanic eruption modeling, and 3-D fracking modeling.

Background and Research Objectives

IGPPS plays an important role within the major LANL scientific sectors of: geoscience, global climate, planetary science, and astrophysics. The institute spawns new scientific directions, bringing additional talent and breadth to the laboratory (in the form of academic visitors, students, postdocs, and staff employees), and in establishing connectivity and productive collaborations between LANL and academic scientists. IGPPS serves as both a recruitment and retention tool, providing Los Alamos researchers with professional growth opportunities to expand technical capabilities into new areas of personal interest, simultaneously aligned with DOE and Laboratory institutional technical objectives. These are important contributions to LANL's scientific leadership and sustainability as a world-class scientific establishment and national security laboratory.

Scientific Approach and Accomplishments

We highlight some of the 45 separate research studies that often involved collaborations with 20 Universities. University graduate students spent approximately 2 contact-years at Los Alamos, side-by-side with LANL researchers. Senior faculty principal investigators spent in excess of 144 contact-days at the Lab. We direct you to the publication list to learn more about IGPPS sponsored studies.

Astrophysics

Big Bang nucleosynthesis has been an amazing success story, seeking to correctly predict the relative abundance of the elements produced by the cosmic big bang (H, He, Li) even though the relative abundances span 6 orders of magnitude. Although the Li-7 abundance differs from predictions by a factor of ~ 3 , the Li-6 is more of a mystery because it disagrees with supercomputer models by a factor of almost 1000. A project with UCSD uses supercomputing to include, for the first time, additional, previously omitted nuclear reactions.

Supernova explosions are another area where knowledge mostly relies on supercomputing. Within supernova physics, neutrino transport is the dominant process, affecting all stages of the implosion of the core and explosion of outer shells. Our collaboration with Cal Tech advances that state of the art by including subtle neutrino effects in the shocks that slow down the collapse, the convection region, and shock bounce. We discovered that subtle changes in cooling significantly changed the heating and cooling balance resulting in large variations in explosion time scales.

For several decades after Los Alamos discovered gamma-rays bursts, there was dearth of data. New satellites such as the Swift satellite (which Los Alamos helped design and build) have collected detailed data for about 1000 bursts. A project with Ohio University models the jets of ejected material when a massive spinning star collapses

into a black hole, producing a gamma-ray burst. The models are compared to gamma-ray, x-ray, optical, and radio observations to determine the initial conditions in the jet, thus defining aspects of the black hole collapse.

Stemming from Milagro, a LANL-designed water-based detector experiment, The High Altitude Water Cherenkov Observatory (HAWC) consists of 300 water tanks in the Mexican mountains. Incoming cosmic rays and extremely high-energy photons produce showers of secondary particles from which HAWC can determine the original direction, thus mapping the sky (Figure 1). Research with the University of Wisconsin provides crucial calibrations of the background. Correcting for the background is key to studying the surprising result that cosmic ray emissions are not uniformly distributed across the sky; there is a large-scale directional variability with hot spots. An explanation for the discovered “anisotropy” is yet to be found.

There has been a long-term debate whether magnetic fields or turbulence dominate the time scale for interstellar clouds to collapse producing stars. With Florida State, we include both effects in supercomputer models of cloud collapse. The magnetic fields can slow collapse through slowing diffusion. Turbulence provides kinetic support that reduces the fraction of mass available for collapse. The combined model should reproduce the observed energy balance in star forming regions.

The discovery of ~ 2000 planets around stars is one of the hottest topics in astrophysics. A big surprise is the presence of Jupiter-sized gas planets orbiting stars in only a few days. How could these “hot Jupiters” form and survive so close to a star? A project with UC Santa Cruz uses a large hydrodynamics code to study how planets form further away from the star (like our Jupiter) and subsequently migrate closer to the star.

Space

In partnership with the New Mexico Consortium, Los Alamos developed a citizen science website, <http://www.aurorasaurus.org> to filter Twitter Tweets for real-time tracking of aurora sightings. End users benefit from pin-point forecasts of space weather activity, essentially mapping the auroral oval in real time. Increasing public appreciation and literacy of a scientific phenomenon while generating scientifically valuable data is an added benefit. NSF provided \$ 1 million of follow-on work to the New Mexico Consortium/Los Alamos collaborators.

Accurate specification of the magnetic field surrounding the Earth provides powerful constraints on theories of magnetic storms and substorms and allows us to better predict the hazardous satellite-damaging radiation belt

particle populations in space. One collaborative project with UCLA melds a novel modeling approach together with NASA spacecraft particle measurements to derive robust, validated magnetic field models for a variety of magnetospheric disturbance levels.

One effort developed the first integrated ionospheric/magnetospheric model for ring currents (electric current flowing toroidally around the Earth). Changes in current are responsible for geomagnetic storms that can severely affect technological systems, possibly causing permanent damage to telecommunication and navigation satellites, cables, or power grids. In particular, ring current models were combined with other first principle codes to understand the importance of ionospheric oxygen and the solar wind in the inner magnetosphere. This can be used to exploit data from the Van Allen Probe satellite currently investigating the magnetosphere.

A groundbreaking discovery of NASA’s Cassini mission to Saturn was the existence of a water-vapor plume on Saturn’s moon, Enceladus. It is believed that underground oceans on Enceladus feed the plume, which then ejects water vapor into space. Such plumes, under study with UCLA, are primary sources of water ions in Saturn’s magnetosphere. Understanding space-time variations of the source rate is critical for predicting overall dynamics and circulation of Saturn’s magnetosphere.

Using Los Alamos instrumentation on Stereo, Wind, ACE, and the Venus Express satellites, with UCLA, we studied the interaction between the solar wind and dust. Dust accelerated by the solar wind can reach speeds that are a danger to robotic and manned missions. It was determined that the interplanetary field was coupled to enhancements of dust.

Signatures

IGPPS conducted a summer cubesat workshop with technical staff members and program management. The goals included identification of national security mission interests, reviewing appropriate mission payloads, and determining payload requirements. IGPPS funded twelve concepts for further development (in progress).

The science of signatures focus area funded limited studies in three areas: (1) understanding current technologies and their limitations for sensing and detecting hydrazine to develop new strategies and materials for understanding potential signatures; (2) the initial development of the automated extraction and representation of uncertain numerical values from text with the goal of developing a two-stage lexical and syntactic parser for linguistic hedge terms called approximators for signature discovery in

unstructured text; and (3) examined a number of ideas regarding the implementation of firing point standardized diagnostics for a standardized recording system concept to provide consistent and persistent signature data from LANL firing point tests.

Climate

With the University of Colorado, remote UAV observations from NASA's CASIE campaign in the Fram Strait were used to characterize sea-ice surface roughness, deformed ice-fractions and pond-area generated by "real-world" sea ice mechanics. Analysis identified two key parameters controlling sea ice ridging and its thickness distribution for optimization in CICE, LANL's sea ice model. Comparisons with Fram Strait CASIE data indicate that one can meaningfully constrain the parameters. This research directly improves CICE simulations of sea ice thickness distributions, reducing uncertainty in predicting Arctic sea ice evolution.

Ice-sheet, surface melt water creates moulins or pours into crevasses, lubricating the ice-sheet bed causing basal sliding. CryoHydrologic warming occurs when melt water refreezes within englacial systems which is faster than surface heat conduction. Does ice melt and flows change on decadal time scales? Preliminary LANL Community Ice Sheet Model (CISM) simulations indicated that liquid water can persist in 1m wide crevasses for ~ 5-20 years, depending on initial ice temperature and crevasse spacing. Micro-scale laboratory ice experimental results with University of Colorado collaborators were used to derive analytical parameterization to determine the critical discharge value, above which internal heat generation with an englacial conduit in cold ice can lead to conduit growth. This new treatment is improving "enthalpy-based" treatment of ice sheet ablation zones in CISM.

Arctic plants require snow cover for protection making them vulnerable to early warming. LANL built a long term monitoring site with Norwegian collaborators at the Abisko, Sweden, field station, which is becoming an established LANL-Norway site for long-term data collection and research. LANL instrumentation was deployed to monitor plant abundance, stomatal conductance, water transport, soil sampling, and leaf photosynthetic activity. Controlled plots were established to examine the effects of early snowmelt on vegetation. Preliminary results indicate that the timing of snowmelt has a large impact on the ecosystem.

Global warming is often attributed to the burning of fossil fuels, but the division between natural and anthropogenic components remains uncertain. Most predictions rely on computer-based simulations that are based on fundamental physical, chemical and biological processes.

IGPPS sponsored research in collaboration with Texas A&M uses semi-empirical statistical models to correlate known anthropogenic forcing by greenhouse gases and aerosols, solar variations, and natural oceanic and atmospheric variability with observed global warming. The observed annual, mean global temperature time series is better captured when the "Atlantic Multidecadal Oscillation, AMO" (cyclic sea-surface temperature variations), is included. We can account for 92% of the observed annual mean global temperature variance by including anthropogenic greenhouse gases and aerosols data, and AMO as predictors. Similar analyses of the Arctic and the southwestern US reveal that inclusion of the AMO better describes regional warming.

LANL with Harvard developed ICOS (off-axis Integrated-Cavity-Output-Spectroscopy), a fast and sensitive methane isotope sensor. ICOS detects mass differences between "isotopically" lighter and heavier methane molecules, $^{12}\text{CH}_4$ versus $^{13}\text{CH}_4$. Biogenic sources (e.g. vegetative) are associated with lighter molecules while heavier methane is associated with fossil fuels (e.g. gas or oil). ICOS was integrated into the FOCAL, Flux Observations of Carbon from an Airborne Laboratory, platform (Figure 3) and deployed to Alaska. Airborne Arctic measurements clearly differentiated between releases from local biogenic sources (tundra) and fossil-energy-related long-range plumes, emanating from Prudhoe Bay oil and gas facilities. These first regional-scale, methane flux attribution results will be presented at the December 2014, American Geophysical Union conference.

Geoscience

An increasingly important national security challenge is to accurately locate (few km or better) small "tremors" in remote parts of the globe. Are they natural earthquakes, mine blasts, or clandestine nuclear tests? In order to better understand earthquakes, IGPPS sponsored development of unique approaches for simultaneous inversion of disparate data sets (including gravity and seismic) to make unified crustal models of Euroasia and the western U. S. To improve location, discrimination, and yield estimates of small explosions we also used new measurement and imaging methods to map attenuation of the complex surface shear-waves in China and North Korea (Figure 3).

To understand how shaking on a fault can trigger catastrophic slip on adjacent faults, we conducted laboratory studies to quantify the time-dependent strengthening and dynamic stress drop across a modeled fault under increasing normal stress and contrasting hydrologic conditions. Stress drop increases with stick-slip recurrence time. We suggest that physio-chemical processes, acting at grain junctions and influenced by fluid pressure during shear, control aseismic creep and thus influence nucleation

and propagation of earthquakes. Our research provides evidence that earthquakes can be triggered when applied sound-wave amplitudes in adjacent crustal blocks exceed a threshold strain (Johnson et al., 2013). This work contributes to on-going DOE- and LDRD-supported research on acoustical properties of materials.

While large volcanic eruptions can neither be predicted nor controlled, a better understanding of eruption dynamics may help mitigate their hazards. Through numerical modeling we determined that the primary control on whether an erupted gas and ash column ascends in a buoyant plume or collapses into pyroclastic, ground-hugging flows is the shape of the vent. An increasing vent angle increases jet diameter and decreases jet velocity, affecting the transition to pyroclastic flows. Production of shock waves is dependent on vent shape and on the magnitude of decompression. Vent pressure controls crater formation as well as entrainment and distribution of rock material from conduit walls. In addition, other factors such as inelastic deformation and erosion of conduit walls, density and size of entrained particles (Figure 4), and evolution of vent shape through erosion are critical. Particulate size has a large effect on shock structures and eddy formation in the near-vent region of overpressured eruption columns. Real-time monitoring of in-progress eruptions may help guide mitigation strategies.

Advanced numerical modeling permits the evaluation of large-scale fluid-flow processes that cannot be investigated in the field or laboratory. Existing codes, (FEHM, PFLOTRAN) were upgraded by including new 3-D phenomenology, specifically by incorporating newly developed Discrete Fracture Network capabilities in PFLOTRAN implementations, the effect of reactive transport of aqueous fluids and of methane in a variety of engineered and natural systems, such as hillside drainage, fracking, and acid rock drainage. This work significantly expands the numerical tools available to researchers studying a variety of natural and engineered systems and provides major increases in realism of the models. The robust participation of students and outside collaborators in this work has brought new expertise regarding fluid flow and fracturing to the Laboratory and spawned new LDRD funding.

Energy security, involving discovering and characterizing new resources as well as mitigating adverse effects related to exploitation are of paramount national security concern. Using new conceptual models based on field exploration, we developed numerical models to better predict where geothermal systems are to be expected, how large they are, and the total enthalpy (energy) of the systems. The same models apply to better predicting the effects of fluid injection (e.g., waste-water injection; “fracking”) to in-

duced seismicity. This work has directly led to new proposals submitted to DOE Geothermal.

Impact on National Missions

The research significantly improves our understanding of classes of earthquakes, volcanic dynamics, and fracking to allow society to mitigate catastrophic phenomena. This contributes to higher fidelity prediction of onset of some natural geophysical events to determine evacuation routes, better preservation of property or critical natural resources and infrastructure protection.

Global climate research continues to improve understanding of what may be a “natural” versus anthropogenic-induced climate change, contributing to better informed national policy implementation to preserve a human-friendly climate. Aspects of the modeling work migrates to other agencies such as NOAA, NCAR, and elements of DOE’s Office of Science for application in large-scale climate studies, that also influence Congressional/Presidential policy.

The astrophysics and space science studies directly bear on understanding and better predicting hostile space environments affecting satellite survivability. IGPPS contributions can directly impact NASA, DOD, DOE, NSF and other federal agency programs.

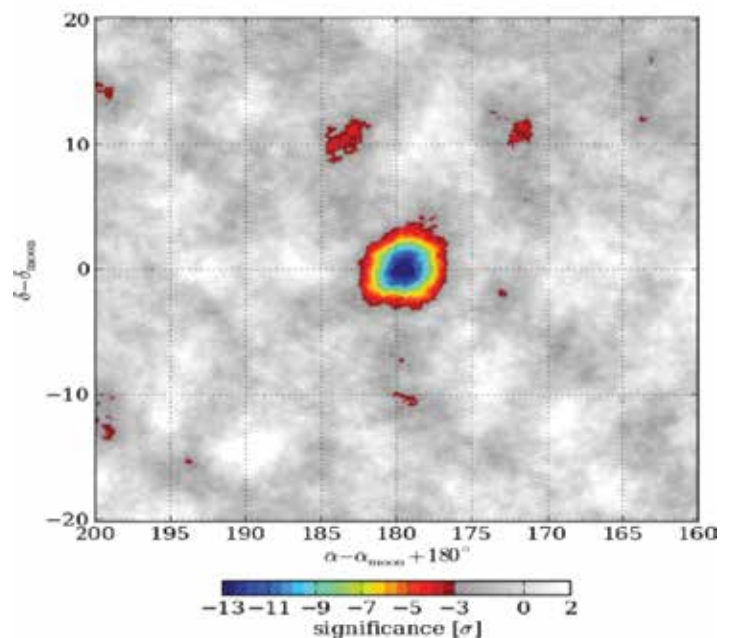

Figure 1. First HAWC result: Moon casts a shadow, blocking cosmic rays. Data corrected for bending of charged cosmic rays by earth’s magnetic field.

References

1. For details on all studies refer to Publications. N/A.

Publications

Abdo, A. A., A. U. Abeysekara, B. T. Allen, T. Aune, D. Berley, C. Chen, G. E. Christopher, T. DeYoung, B. L. Dingus, R. W. Ellsworth, M. M. Gonzalez, J. A. Goodman, J. Granot, E. Hays, C. M. Hoffman, P. H. Hunttemeyer, B. E. Kolterman, J. T. Linnemann, J. E. McEnery, A. I. Mincer, T. Morgan, P. Nemethy, J. Pretz, E. Ramirez-Ruiz, J. M. Ryan, P. M. Parkinson, A. Shoup, G. Sinnis, A. J. Smith, V. Vasileiou, G. P. Walker, D. A. Williams, and G. B. Yodh. Constraints on the emission model of the “naked-eye burst” GRB 080319B. 2012. *Astrophysical Journal, Letters*. 753 (2): L31 (5 pp.).

Abdo, A. A., B. T. Allen, R. Atkins, T. Aune, W. Benbow, D. Berley, E. Blaufuss, E. Bonamente, J. Bussons, C. Chen, G. E. Christopher, D. G. Coyne, T. DeYoung, B. L. Dingus, D. E. Dorfan, R. W. Ellsworth, A. Falcone, L. Fleysher, R. Fleysher, J. Galbraith-Frew, M. M. Gonzalez, J. A. Goodman, T. J. Haines, E. Hays, C. M. Hoffman, P. H. Hunttemeyer, L. A. Kelley, B. E. Kolterman, C. P. Lansdell, J. T. Linnemann, J. McCullough, J. E. McEnery, T. Morgan, A. I. Mincer, M. F. Morales, P. Nemethy, D. Noyes, J. Pretz, J. M. Ryan, F. W. Samuelson, P. M. Parkinson, A. Shoup, G. Sinnis, A. J. Smith, G. W. Sullivan, V. Vasileiou, G. P. Walker, M. Wascko, D. A. Williams, S. Westerhoff, and G. B. Yodh. OBSERVATION AND SPECTRAL MEASUREMENTS OF THE CRAB NEBULA WITH MILAGRO. 2012. *ASTROPHYSICAL JOURNAL*. 750 (1): 63.

Abdo, A. A., U. Abeysekara, B. T. Allen, T. Aune, D. Berley, E. Bonamente, G. E. Christopher, T. DeYoung, B. L. Dingus, R. W. Ellsworth, J. G. Galbraith-Frew, M. M. Gonzalez, J. A. Goodman, C. M. Hoffman, Hu¨, C. M. Hui, B. E. Kolterman, J. T. Linnemann, J. E. McEnery, A. I. Mincer, T. Morgan, P. Nemethy, J. Pretz, J. M. Ryan, P. M. Parkinson, A. Shoup, G. Sinnis, A. J. Smith, V. Vasileiou, G. P. Walker, D. A. Williams, and G. B. Yodh. Spectrum and morphology of the two brightest Milagro sources in the Cygnus region: MGRO J2019+37 and MGRO J2031+41. 2012. *Astrophysical Journal*. 753 (2): 159 (8 pp.).

Abeysekara, A. U., J. A. Aguilar, S. Aguilar, R. Alfaro, E. Almaraz, C. Alvarez, J. de D. Alvarez-Romero, M. Alvarez, R. Arceo, J. C. Arteaga-Velazquez, C. Badillo, A. Barber, B. M. Baughman, N. Bautista-Elivar, E. Belmont, E. Benitez, S. Y. BenZvi, D. Berley, A. Bernal, E. Bonamente, J. Braun, R. Caballero-Lopez, I. Cabrera, A. Carraminana, L. Carrasco, M. Castillo, L. Chambers, R. Conde, P. Condreay, U. Cotti, J. Cotzomi, J. C. D,ÃÓlivo, E. de la Fuente, C. De Leon, S. Delay, D. Delapine, T. DeYoung, L. Diaz, L. Diaz-Cruz, B. L. Dingus, M. A. Duvernois, D. Edmunds, R. W. Ellsworth, B. Fick, D. W. Florino, A. Flandes, N. I. Fraija, A. Galindo, J. L. Garcia-Luna, G. Garcia-Torales, F. Garfias, L. X. Gonzalez,

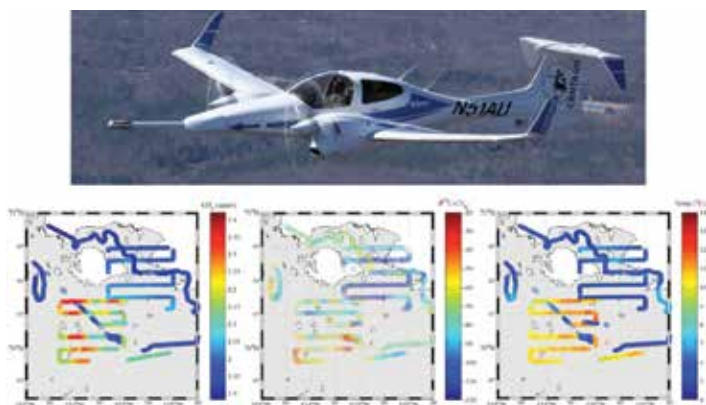

Figure 2. (Top) Aircraft with sensor package surveying Alaska Arctic. (Bottom) (Left) Methane from August 26 - 28, 2013 flights. (Center) Methane isotopic ratios for same period. (Right) Measure fiber-optic air temperature

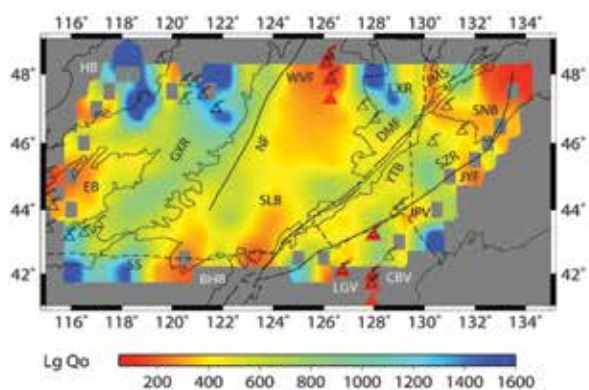

Figure 3. L, Q (attenuation) image of NE China. Black lines indicate major active faults in Northeast China. Blue represents high Q (low attenuation) anomalous regions and red represents low Q (high attenuation) regions. Low attenuation regions are mainly in the mountainous regions. High attenuation regions are associated with Quaternary volcanic fields and sedimentary basins. From Ranasinghe et al, 2014.

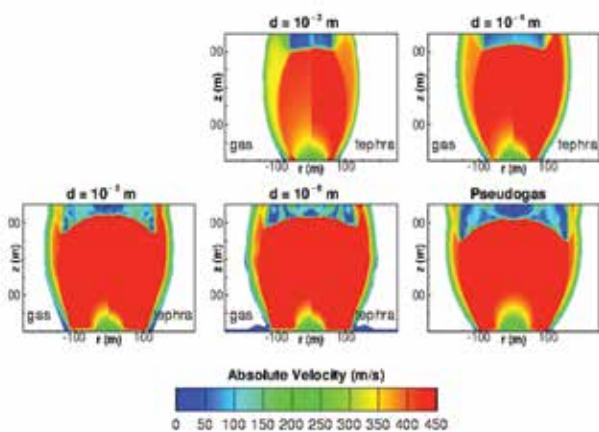

Figure 4. Volcanic Jets: Particle and gas velocities for otherwise identical jets with different particle sizes.

- M. M. Gonzalez, J. A. Goodman, V. Grabski, M. Gussert, C. Guzman-Ceron, Z. Hampel-Arias, T. Harris, E. Hays, L. Hernandez-Cervantes, P. H. Huntemeyer, A. Imran, A. Iriarte, J. J. Jimenez, P. Karn, N. Kelley-Hoskins, D. Kieda, R. Langarica, A. Lara, R. Lauer, W. H. Lee, E. C. Linares, J. T. Linnemann, M. Longo, R. Luna-Garcia, H. Martinez, J. Martinez, L. A. Martinez, O. Martinez, J. Martinez-Castro, M. Martos, J. Matthews, J. E. McEnery, G. Medina-Tanco, J. E. Mendoza-Torres, P. A. Miranda-Romagnoli, T. Montaruli, E. Moreno, M. Mostafa, M. Napsuciale, J. Nava, L. Nellen, M. Newbold, R. Noriega-Papaqui, T. Ocegueda-Becerra, A. Tapia, V. Orozco, V. Perez, E. G. Perez-Perez, J. S. Perkins, J. Pretz, C. Ramirez, I. Ramirez, D. Rebello, A. Renteria, J. Reyes, D. Rosa-Gonzalez, A. Rosado, J. M. Ryan, J. R. Sacahui, H. Salazar, F. Salesa, A. Sandoval, E. Santos, M. Schneider, A. Shoup, S. Silich, G. Sinnis, A. J. Smith, K. Sparks, W. Springer, F. Suarez, N. Suarez, I. Taboada, A. F. Tellez, G. Tenorio-Tagle, A. Tepe, P. A. Toale, K. Tollefson, I. Torres, T. N. Ukwatta, J. Valdes-Galicia, P. Vanegas, V. Vasileiou, O. Vazquez, X. Vazquez, L. Villasenor, W. Wall, J. S. Walters, D. Warner, S. Westerhoff, I. G. Wisher, J. Wood, G. B. Yodh, D. Zaborov, and A. Zepeda. On the sensitivity of the HAWC observatory to gamma-ray bursts. 2012. *ASTROPARTICLE PHYSICS*. 35 (10): 641.
- Abeysekara, A. U., R. Alfaro, C. Alvarez, J. D. Alvarez, R. Arceo, J. C. Arteaga-Velazquez, H. A. Ayala Solares, A. S. Barber, B. M. Baughman, N. Bautista-Elivar, E. Belmont, S. Y. BenZvi, D. Berley, M. Bonilla Rosales, J. Braun, K. S. Caballero-Mora, A. Carraminana, M. Castillo, U. Cotti, J. Cotzomi, E. de la Fuente, C. De Leo, T. DeYoung, R. Diaz Hernandez, J. C. Diaz-Velez, B. L. Dingus, M. A. DuVernois, R. W. Ellsworth, D. W. Fiorino, N. Fraija, A. Galindo, F. Garfias, M. M. Gonzales, J. A. Goodman, M. Gussert, Z. Hampel-Arias, J. P. Harding, P. Huntemeyer, C. M. Hui, A. Imarn, A. Iriarte, P. Karn, D. Kieda, G. J. Kunde, A. Lara, J. Lauer, W. H. Lee, D. Lennarz, H. Leon Vargas, J. T. Linnemann, M. Longo, R. Luna-Garcia, K. Malone, and A. Marinelli. Observation of Small-scale Anisotropy in the Arrival Direction Distribution of TeV Cosmic Rays with HAWC. *Astrophysical Journal*.
- Abeysekara, A. U., R. Alfaro, C. Alvarez, J. D. Alvarez, R. Arceo, J. C. Arteaga-Velazquez, H. A. Ayala Solares, A. S. Barber, B. M. Baughman, N. Bautista-Elivar, E. Belmont, S. Y. BenZvi, D. Berley, M. Bonilla Rosales, J. Braun, R. A. Caballero-Lopez, A. Carraminana, M. Castillo, U. Cotti, J. Cotzomi, E. de la Fuente, C. De Leon, T. DeYoung, R. Diaz Hernandez, J. C. Diaz-Velez, B. L. Dingus, M. A. DuVernois, R. W. Ellsworth, A. Fernandez, D. W. Fiorino, N. Fraija, A. Galindo, J. L. Garcia-Luna, G. Garcia-Torales, F. Garfias, L. X. Gonzales, M. M. Gonzales, J. A. Goodman, V. Grabski, M. Gussert, Z. Hampel-Arias, C. M. Hui, P. Huntemeyer, A. Imran, A. Iriarte, P. Karn, D. Kieda, G. J. Kunde, A. Lara, R. J. Lauer, W. H. Lee, D. Lennarz, and H. Leon Vargas. Sensitivity of the high altitude water Cherenkov detector to sources of multi-TeV gamma rays. 2013. *ASTROPARTICLE PHYSICS*. 50-52: 26.
- Barriere, N. M., E. C. Belhm, V. Bhalerao, S. E. Boggs, S. B. Cenko, F. E. Christensen, W. W. Craig, K. Forster, C. Fryer, C. J. Hailey, F. A. Harrison, A. F. Horesh, C. Kouveliotou, K. K. Madsen, J. M. Miller, E. O. Ofek, D. A. Perley, V. R. Rana, S. P. Reynolds, D. I. Stern, J. A. Tomsick, and W. W. Zhang. X-RAY SPECTRAL COMPONENTS OBSERVED IN THE AFTERGLOW OF GRB 130925A. 2014. *ASTROPHYSICAL JOURNAL LETTERS*. 784 (2): na.
- Baughman, B., J. Braun, J. A. Goodman, A. Imran, B. Patricelli, and J. Pretz. HAWC Observations of the Crab Nebula. . 2013. In 33rd International Cosmic Ray Conference (ICRC 2013). (Rio De Janeiro, January 2013). , p. na. Brazil: ICRC 2013.
- Chylek, P., C. Folland, L. Frankcombe, H. Dijkstra, G. Lesins, and M. Dubey. Greenland ice core evidence for spatial and temporal variability of the Atlantic Multidecadal Oscillation. 2012. *GEOPHYSICAL RESEARCH LETTERS*. 39: L09705.
- Chylek, P., J. Klett, G. Lesins, M. Dubey, and N. Hengartner. The Atlantic multidecadal oscillation as a dominant factor of oceanic influence on climate. 2014. *Geophysical Research Letter*. 41 (5): 1689.
- Chylek, P., M. K. Dubey, G. Lesins, J. Li, and N. Hengartner. Imprint of the Atlantic multi-decadal oscillation and Pacific decadal oscillation on southwestern US climate: past, present, and future. 2014. *Climate Dynamics*. 43 (-2): 119.
- Chylek, P., N. Hengartner, G. Lesins, M. Dubey, J. Klett, and O. Humlum. Isolating the anthropogenic component of Arctic warming. 2014. *Geophysical Research Letters*. 41 (10): 3569.
- Cirigliano, V., G. Fuller, and A. Vlasenko. A new spin on neutrino quantum kinetics . *High Energy Physics - Phenomenology*. : 1.
- Coblentz, D., F. Pabian, and L. Prasad. Quantitative geomorphometrics for terrain Characterization. 2014. *International Journal of Geosciences*. : 247.
- Connors, M., C. T. Russell, H. R. Lai, and J. G. Luhmann. Hazards associated with asteroid (138175) 2000 EE104: Temporary Earth co-orbital linked to interplanetary field enhancements. 2014. In *Asteroids Comets Meteors (ACM 2014)*. (Helsinki, June 30-July 4, 2014). , p. NA. Helsinki: Asteroids, Comets, Meteors.
- Connors, M., H. R. Lai, H. Y. Wei, and C. T. Russell. The temporal variation of the rate of interplanetary enhancements seen in association with Asteroids 2201 Oljato and 138175 at Earth: Evidence for co-orbital material disturbed by gravitational interactions. 2014. In *The*

- Solar System Exploration Research Virtual Institute . (Moffett Field, CA, July 21-23, 2014). , p. na. United States: SSERVI Forum.
- Dean, C., P. Reimus, J. Oates, P. Rose, D. Newell, and S. Petty. Laboratory experiments to characterize cation-exchanging tracer behavior for fracture surface area estimation at Newberry, Crater, OR. 2015. *Geothermics*. 53: 213.
- Dean, C., P. Reimus, and D. Newell. Evaluation of a Cation Exchanging Tracer to Interrogate Fracture Surface Area in EGS Systems. 2012. In *Thirty-Seventh Workshop on Geothermal Reservoir Engineering* . (Stanford, California, Jan 30-Feb 1, 2012). , p. na. United States: Stanford Geothermal Program.
- Dean, C., P. Reimus, and D. Newell. The temporal variation of the rate of interplanetary enhancements seen in association with Asteroids 2201 Oljato and 138175 at Earth: Evidence for co-orbital material disturbed by gravitational interactions. 2014. In *The Solar System Exploration Research Virtual Institute* . (Moffett Field, CA, July 21-23, 2014). , p. na. United States: SSERVI Forum.
- Elst, N. van der, E. Brodsky, P.-Y. Le Bas, and P. Johnson. Auto-acoustic compaction in steady shear flows: Experimental evidence for suppression of shear flows: Experimental evidence for suppression of shear dilatancy by internal acoustic vibration. 2012. *Journal of Geophysical Research - Solid Earth*. 117 (B9): 1029.
- Ferdowsi, B., M. Griffa, R. A. Guyer, P. A. Johnson, A. Marone, and J. Carmeliet. Three-dimensional discrete element modeling of triggered slip in sheared granular media. 2014. *Physical Review E*. 89: na.
- Ferdowsi, B., M. Griffa, R. A. Guyer, P. A. Johnson, C. Marone, and J. Carmeliet. Microslips as precursors of large slip events in the stick-slip dynamics of sheared granular layers: A discrete element model analysis. 2013. *Geophysical Research Letters*. 40 (6): 4194.
- Fiorino, D. W., S. BenZvi, and J. Braun. Observation of the Moon Shadow and Characterization of the Point Response of HAWC-30. 2013. In *33rd International Cosmic Ray Conference Janeiro 2013*. (Rio De Janeiro, July 4-6, 2013). , p. 1. Rio de Janeiro: CBPF.
- Flowers, B. A., H. H. Powers, M. K. Dubey, and N. G. McDowell. Inter-comparison of two high-accuracy fast-response spectroscopic sensors of carbon dioxide: a case study. 2012. *ATMOSPHERIC MEASUREMENT TECHNIQUES*. 5 (5): 991.
- Fu, W., H. Li, S. Lubow, and S. Li. Long term evolution of Planet-induced vortices in protoplanetary disks. 2014. *Astrophysical Journal Letters*. 788 (2): L41.
- Gao, H., Y. Song, Y.-C. Chang, X. Shi, Q.-Z. Yin, R. C. Wiens, W. M. Jackson, and C. Y. Ng. Branching ratio measurements for vacuum ultraviolet photodissociation of 12C 16O. 2013. *Journal of Physical Chemistry*. : 6185.
- Gaulme, P., J. McKeever, M. L. Rawls, J. Jackiewicz, B. Mosser, and J. Guzik. Red Giants in Eclipsing Binary and Multiple - Star Systems: modeling and Asteroseismic Analysis of 70 Candidates from Kepler Data. 2013. *Astrophysical Journal*. 767 (82): 22.
- Griffa, M., B. Ferdowsi, E. G. Daub, R. A. Guyer, P. A. Johnson, C. Marone, and J. Carmeliet. Meso-mechanical analysis of deformation characteristics for dynamically triggered slip in a granular medium. 2012. *Philosophical Magazine*. : 1.
- Griffa, M., B. Ferdowsi, R. A. Guyer, E. G. Daub, P. A. Johnson, C. Marone, and J. Carmeliet. Influence of vibration amplitude on dynamic triggering of slip in sheared granular layers. 2013. *American Physical Society*. : 012205.
- Herzfeld, U. C., E. Hunke, and B. McDonald. Sea-ice ridging in Fram Strait - A comparison between results from the Los Alamos sea-ice model CICE and parameterization of high resolution observations from unmanned aircraft. To appear in *Journal of Geophysical Research: Oceans*.
- Herzfeld, U. C., E. Hunke, and B. McDonald. Sea-ice ridging in Fram Strait - A comparison between results from the Los-Alamos sea-ice model CICE and parameterization of high-resolution observations from unmanned aircraft . *The Cryosphere Discussion*.
- Herzfeld, U., E. Hunke, and B. McDonald. Ice deformation in fram strait - comparison of CICE simulations with analysis and classification airborne remote-sensing data. Invited presentation at CESM Polar Climate Working Group Meeting . (Boulder, CO, Feb. 11-13-2013).
- Herzfeld, u., E. Hunke, and B. McDonald. Sea-ice ridging in Fram Strait - a model-data comparison. Invited presentation at CESM Polar Climate Working Group Meeting. (Beckrenridge, CO, June 24 - July 26, 2013).
- Hunke, E. C.. Sea ice volume and age: Sensitivity to physical parameterizations and resolution in the CICE sea ice model. To appear in *Ocean Modelling*.
- Hunke, E., U. Herzfeld, and B. McDonald. Evaluation of Mechanical Deformation in the Los Alamos Sea Ice Model, CICE. Invited presentation at COSIM Seminar. (Los Alamos, NM, January 2013).
- Johnson, P. A., B. Ferdowsi, B. M. Kaproth, M. Scuden, M. Griffa, J. Carmeliet, R. A. Guyer, P.-Y. Le Bass, D. T. Trugman, and C. Marone. Acoustic emission and microslip

- precursors to stick-slip failure in sheared granular material. 2013. *Geophysical Research Letters*. 40 (21): 5627.
- Johnson, P., B. M. Carpenter, M. Knuth, B. M. Kaproth, P. -Y. Le Bas, E. G. Daub, and C. Marone. Nonlinear dynamical triggering of slow slip on simulated earthquake faults with implications to Earth. 2012. *Journal of Geophysical Research- Solid Earth*. 117 (B5): na.
- Lai, H. R., C. T. Russell, H. Y. Wei, G. L. Delzanno, and M. Connors. Identifying potentially hazardous 50-m class co-orbiting materials associated with known "safe" near-earth objects. 2014. In 45th Lunar and Planetary Science Conference. (The Woodlands, TX, March 17-21, 2014). , p. na. United States: USRA.
- Lai, H. R., C. T. Russell, H. Y. Wei, G. L. Delzanno, and M. Connors. Potentially hazardous co-orbiting material of Asteroid 138175 identified by interplanetary field enhancements. 2014. In European Geosciences Union General Assembly 2014. (Vienna Austria, April 27- May 2, 2014). , p. na. Austria: EGU.
- Lai, H. R., C. T. Russell, H. Y. Wei, G. L. Delzanno, and M. Connors. Monitoring hazardous near-Earth object debris at 1 AU using interplanetary magnetic signatures resulting from meteoroid-asteroid collisions. 2014. In Asteroids Comets Meteors 2014. (Finland, Helsinki, June 30-July 4, 2014). , p. na. Finland: Asteroids Comets Meteors.
- Lai, H. R., C. T. Russell, H. Y. Wei, and G. L. Delzanno. Identifying meteor streams containing 10-m bodies in near-Earth space and determining their temporal evolution. 2013. In American Geophysical Union Fall Meeting. (San Francisco, CA, Dec 9-13, 2013). , p. na. United States: NASA Astrophysics Data System.
- Lai, H. R., C. T. Russell, M. Connors, H. Y. Wei, and G. L. Delzanno. You know where the parent body is but where are the co-orbitals?. Invited presentation at Solar System Exploration Research Virtual Institute (SSERVI) Meeting. (Moffett Field, CA, July 21-23, 2014).
- Lai, H. R., M. A. Connors, C. T. Russell, and H. Y. Wei. The detection of collisional and scattering processes in the asteroid-meteoroid continuum. Invited presentation at European Planetary Science Congress (EPSC) 2014. (Cascais, Portugal, Sept. 1-12, 2014).
- Lai, H., C. T. Russell, G. L. Delzanno, and H. Y. Wei. Collisions in space: Nanoscale dust pickup as an indicator of the collision rate in interplanetary space. Invited presentation at Asteroids, Comets, Meteors (ACM) Meeting. (Japan, May 16-20, 2014).
- Lai, H., C. T. Russell, and G. L. Delzanno. Probable cause of interplanetary field enhancements: destructive collisions of small bodies. Invited presentation at COSPAR 2012. (Mysore, India, July 14-July 22, 2012).
- Lindenmaier, R., M. Dubey, B. G. Henderson, Z. T. Butterfield, J. R. Herman, and T. Rahn. Multiscale observations of CoO₂, 13Co₂, and pollutants at Four Corners for emission verification and attribution. 2014. *Proceedings of the National Academy of Sciences of the United States of America*. 111 (23): 8386.
- MacCarthy, J. K., and C. A. Rowe. Pisces: A practical seismological database library in python. 2014. *Seismological Research Letters*. 85 (4): 905.
- McDonald, B., and E. Hunke. Analysis of IceBridge Data from the Arctic basin. Invited presentation at CESM Polar Climate Working Group Meeting . (Beckrenridge, CO, June 24 - July 26, 2013).
- McDowell, N. G., N. C. Coops, P. Beck, J. Chambers, C. Gangodagamage, J. A. Hicke, C. Huang, R. Kennedy, D. Krofcheck, M. Litvak, A. Meddens, J. Muss, R. Negron-Juarez, C. Peng, A. Schwantes, J. J. Swenson, L. Vernon, A. P. Williams, C. Xu, M. Zhao, S. Running, and C. Allen. How global satellite monitoring improves our knowledge of vegetation disturbances. *Ecology Letters*.
- Mesler, R. A., J. Whalen, J. Smidt, C. Fryer, N. M. Lloyd-Ronning, and Y. M. Pihlstrom. The First Gamma-Ray Bursts in the Universe . 2014. *Astrophysical Journal*. 787 (1): 787.
- Mesler, R., D. Whalen, N. Lloyd-Ronning, C. Fryer, and Pihlstrom. Gamma-ray Bursts in Circumstellar Shells: A Possible Explanation for Flares. 2012. *Astrophysical Journal*. 757 (2): 117 (11 pp.).
- Paris, M. W., G. M. Hale, A. C. Hayes-Sterbenz, and G. Jungman. R-matrix analysis of reactions in the 9B compound system. *Nuclear Theory*.
- Paris, M. W., G. M. Hale, A. C. Hayes-Sterbenz, and G. Jungman. R-matrix analysis of reactions in the 9B compound system. *Nuclear Theory- Astrophysics*.
- Paris, M. W., L. S. Brown, G. M. Hale, A. C. Hayes-Sterbenz, G. Jungman, T. Kawano, G. M. Fuller, and E. B. Grohs. Toward a self-consistent and unitary reaction network for big bang nucleosynthesis. 2014. *European Physical Journal*. 69: na.
- Person, M., A. Hofstra, D. Sweetkind, W. Stone, D. Cohen, C. Gable, and A. Banerjee. Analytical and numerical models of the hydrothermal fluid flow at fault intersections. 2012. *GEOFLUIDS*. 12 (4): 312.
- Person, M., D. Butler, C. W. Gable, T. Villamil, D. Wavrek, and D. Schelling. Hydrodynamic stagnation zones: A new play concept for the Llano Basin, Colombia. 2012. *American Association of Petroleum Geologist Bulletin*.

96 (1): 23.

- Priedhorsky, R., E. MacDonald, and Y. Cao. First solar maximum with social media: Can space weather forecasting be improved. 2012. In 2012 AGU Fall Meeting. (California, Dec 307, 2012). , p. na. United States: RBSP-ECT .
- Punsal, J. J., C. A. Dean, and P. W. Reimus. Temperature dependence of cation exchange in geothermal applications. 2012. SciTech Connect.
- Reimus, P. W., and M. Williams. Use of Tracers to Interrogate Fracture Surface Area in Single-well tracer Tests in EGS Systems. 2012. In Thirty-Seventh Workshop on Geothermal Reservoir Engineering. (Stanford University, Jan 30-Feb 1, 2012). , p. Reimus. California: Stanford Geothermal Program.
- Riviere, J., T. Candela, M. Scuderi, C. Marone, R. A. Guyer, and P. A. Johnson. On the influence of strain rate in acousto-elasticity: experimental results in Berea sandstone. 2013. In 2013 AGU Fall Meeting. (San Francisco, CA, Dec 9-13, 2013). , p. na. United States: NASA Astrophysics Data System.
- Russell, C. T., H. R. Lai, H. Y. Wei, G. L. Delzanno, and M. Connors. Materials co-orbiting with known NEO asteroids: properties inferred from collision-produced dust clouds. Invited presentation at The 40th COSPAR Scientific Assembly. (Moscow, Russia, August 2-10, 2014).
- Russell, C. T., H. R. Lai, H. Y. Wei, G. L. Delzanno, and M. Connors. Lessons learned from natural space debris in heliocentric orbit: An analogue for hazardous debris in Earth orbit. Invited presentation at The 40th COSPAR Scientific Assembly. (Moscow, Russia, August 2-10, 2014).
- Scuderi, M., B. Carpenter, P. A. Johnson, and C. Marone. Poromechanics of stick-slip frictional sliding and strength recovery on tectonics faults. *Journal of Geophysical Research*.
- Severino, G., D. M. Tartakovsky, G. Srinivasan, and H. Viswanathan. Lagrangian models of reactive transport in heterogeneous porous media with uncertain properties. 2012. *PROCEEDINGS OF THE ROYAL SOCIETY A-MATHEMATICAL PHYSICAL AND ENGINEERING SCIENCES*. 468 (2140): 1154.
- Shi, S., Q. Yin, R. Wiens, and C. -Y. Ng. Isotope composition of atomic oxygen and branching ration from Co predissociation: Implication: Implications for oxygen isotope evolution in the early solar nebula. Presented at 43 Lunar and Planetary Science conference . (Woodlands, Texas, 19-23, 2012).
- Shi, X. Y., Q. -Z. Yin, H. Gao, Y. -C. Chang, W. M. Jackson, and R. C. Wiens. Branching ratios in VUV induced dissociation of CO and N2: Implications for isotopic compositions of the Sun. Presented at The 24th V. M. Goldschmidt Conference. (Sacramento, 8-13 June 2014).
- Shi, X., Q. -Z. Yin, H. Gao, Y. -C. Chang, W. M. Jackson, R. C. Wiens, and C. -Y. Ng. A predissociation branching ratio comparison of CO and N2: Implications for oxygen nitrogen isotope evolution in the yearly solar system. *SCIENCE*.
- Wang, C., C. Yue, S. Zaharia, X. Xing, L. Lyons, V. Angelopoulos, T. Nagai, and T. Lui. Empirical modeling of plasma sheet pressure and three-dimensional force-balanced magnetospheric magnetic field structure: 1. Observations. . 2013. *Journal of Geophysical Research Space Physics*. 118: 6154.
- Wen, F., H. Li, S. Lubow, and S. Li. Long term evolution of planet-induced vortices in protoplanetary disks. 2014. *Astrophysical Journal Letters*. 788 (2): na.
- Wiens, R. C., and Q. -Z. Yin. Isotopic fractionation by photochemical self shielding. Invited presentation at Advancing our Understanding of Solar Wind Fractionation Working Group. (Bern, 30 April - 3 May).
- Yin, Q. -Z., X. Y. Shi, H. Gao, C. -Y. Ng, W. M. Jackson, and R. Wiens. Genesis mission, self-shielding theory, experimental test and implications. Invited presentation at 10th Anniversary Meeting, Jet Propulsion Laboratory. (Pasadena, 8 October 2014).
- Yue, C., C. Wang, G. Zaharia, X. Xing, and L. Lyons. Empirical Modeling of Plasma Sheet Pressure and three-dimensional force-balanced magnetospheric Magnetic field structure: 2. Modeling. 2013. *Geophysical Research Space Physics*. 118: 6166.
- Zhang, X., H. Li, S. Li, and D. N. C. Lin. RESONANCES OF MULTIPLE EXOPLANETS AND IMPLICATIONS FOR THEIR FORMATION. 2014. *ASTROPHYSICAL JOURNAL LETTERS*. 789 (1): na.
- Zhang, X., H. Li, S. Li, and D. N. C. Lin. Migration and growth of protoplanetary embryos I: Convergence of Embryos in Protoplanetary disks . *Astrophysical Journal*.
- Zhang, Y., M. Peters, J. Rupp, K. Ellett, M. A. Celia, C. W. Gable, J. Evans, K. Bandilla, P. Mozley, and T. Dewers. Hydrogeologic controls on induces seismicity in crystalline basement rocks due to fluid injection into basal reservoirs. 2013. *National Ground Water Association*. 51 (4): 525.

Space Hazards Induced near Earth by Large, Dynamic Storms (SHIELDS): Understanding, Modeling, and Predicting

Vania K. Jordanova
20140061DR

Abstract

The main objective of the Space Hazards Induced near Earth by Large, Dynamic Storms (SHIELDS) project is to provide critically needed understanding and modeling capability of energetic particle dynamics in the near-Earth space environment where operational satellites reside. During this one year study, the SHIELDS project investigated the complex dynamic space environment using data from LANL instruments on geosynchronous spacecraft and Van Allen Probes, combined for the first time with computational models and data assimilation methods, to test the model ability to reproduce more accurate inner magnetosphere dynamics. We performed simulations with the LANL ring current model RAM-SCB coupled with the University of Michigan global magnetosphere model BATS-R-US and ionosphere model RIM of a typical substorm injection event observed by the Van Allen Probes on 17 March 2013. Our initial results, published in one of the most prestigious journals in the field, validated unambiguously our hypothesis that substorm injections produce large increases in the hazardous Surface Charging Environment (SCE) consisting of keV range electron fluxes near Earth (~4-6 RE).

Background and Research Objectives

One of the most important space weather hazards is the spacecraft Surface Charging Environment (SCE), i.e. the relatively low energy (less than few 100 keV) electron fluxes, whose enhancement can lead to satellite failures during disturbed conditions. Two mechanisms that may be crucial for the increase of the SCE, but are not included in any existing global model are: a) particle injection during geomagnetic substorms, and b) scattering by plasma waves. Substorms may contribute significantly to the plasma pressure increase through the magnetic field reconfiguration, causing sudden enhancements of the ring current (keV) particle fluxes. On the other hand, plasma waves redistribute energy throughout the collisionless magnetospheric environment through wave-particle interactions that can serve

as an additional mechanism for energy diffusion and particle loss. Including these processes requires models that are targeted at key regions/physics regimes, however, the coupling of these models across multiple spatial and temporal scales remains an extreme challenge. Guided by theory and observations, the overarching goals of the SHIELDS project are to bridge macro- and microscopic computational models, allowing for the first time to study the SCE consequences of substorm and plasma wave dynamics on a global scale. In the limited scope of a one year study, however, we only targeted the physics of substorm injections and the use of data assimilation techniques to test the model's ability to produce more accurate ring current dynamics.

Scientific Approach and Accomplishments

Geomagnetic substorms are one of the main drivers of the surface charging environment (SCE). Substorms are dynamic magnetospheric disruptions wherein the nightside magnetosphere reconfigures on a timescale of minutes; occurring several times during a storm, they release fast plasma flows injecting hot electrons (few to 10's keV) at geosynchronous orbit. To reduce the risk of incorporation of substorm dynamics into global space weather models (since there is no prior guidance available), we explored several techniques capturing substorm injections during this feasibility study.

First, we have coupled a LANL ring current model RAM-SCB [1,2] that uniquely specifies in a self-consistent magnetic field the ion and electron dynamics of the inner magnetosphere with the University of Michigan global magnetosphere model BATS-R-US [3,4] and ionosphere model RIM [5]. Figure 1 shows a simulation with these newly coupled models of the substorm injections observed by the Van Allen Probes on 17 March 2013. This fully self-consistent "two-way" coupled simulation is a radical advancement compared to previous studies that used artificially imposed electromagnetic field pulses to mimic substorm dipolarization and electron transport,

and shows significant improvement in reproducing the observations (Figure 1). Although the data-model agreement is not ideal so far, our initial results [6] published in one of the most prestigious journals in the field, validate unambiguously our hypothesis that substorm injections produce large increases in the SCE (keV range electron fluxes) near Earth ($\sim 4\text{-}6$ RE).

A non-trivial challenge for global magneto-hydro dynamics (MHD) models like BATS-R-US is the issue of timing and spatial extent of the substorm disruption region. These codes initiate substorms through tail magnetic reconnection using finite resistivity to start the reconnection process. To address this challenge and improve the accuracy of substorm phenomenology, we investigated coupling of BATS-R-US with a regional Particle-in-Cell (PIC) code. We thus obtained the MHD with Embedded PIC (MHD-EPIC) algorithm [7] that can successfully model the dayside reconnection in a 2-D magnetosphere simulation (Figure 2). The dayside reconnection region is fully covered by a local implicit PIC model that is “two-way” coupled to the global MHD model. Figure 2 demonstrates that the magnetic islands formed in the PIC domain can smoothly propagate into the MHD region.

Finally, we explored applying data assimilation techniques to produce more accurate inner magnetosphere dynamics. To this end, an assimilation method was implemented for the first time in RAM-SCB using observational flux data from LANL instruments on the Van Allen Probes. These computations performed at the Lab HPC machines (we had a yearly allocation of 11.5M CPU-hours) showed that the assimilation is able to capture substorm phenomena, like clear pressure intensification during the simulated substorm, that would otherwise be missed in unassimilated RAM-SCB simulations.

These studies proved our hypothesis that substorms affect significantly ring current (keV energy) electron fluxes inside geosynchronous orbit, which are the main cause of the spacecraft surface charging.

Impact on National Missions

This one year study led to the successful selection of the SHIELDS proposal for a full, 3-year long, LDRD-DR funding. The SHIELDS framework, a new space weather forecast and reanalysis capability, will have a significant impact on LANL Global Security and Energy Security missions to understand, assess, and predict natural and man-made threats to the space infrastructure. It will also lead to the recruitment and the retention of postdocs at ISR and T divisions.

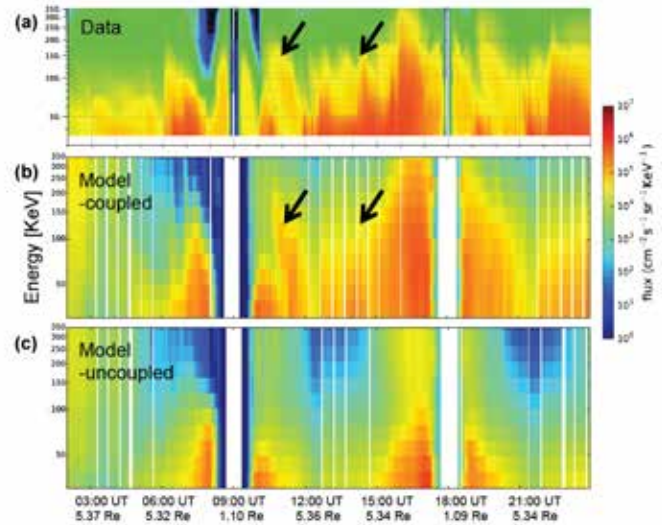

Figure 1. Results from the first substorm simulation [6] we performed with the coupled RAM-SCB, BATS-R-US, and RIM models. Large increases (black arrows) of the near-Earth electron fluxes (a) observed with the Van Allen Probes, are reproduced with (b) the new modeling capability, but not with (c) the old one. These results prove our hypothesis that substorms cause strong enhancements of the SCE electron fluxes inside geosynchronous orbit.

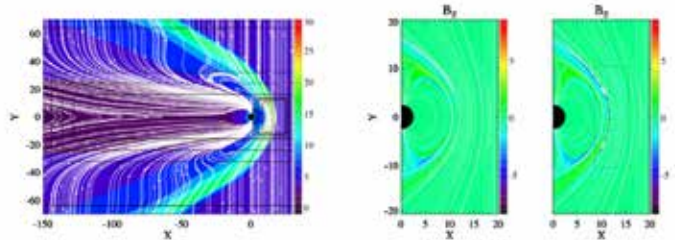

Figure 2. The left panel shows an overview of the 2-D magnetosphere simulation (the Sun is to the right). The colors show density, the white lines are the magnetic field lines. The kinetic region around the dayside reconnection site is shown by the red rectangle. The right two panels show the magnetic field solutions on the dayside without and with embedded kinetic region (black rectangle). The MHD-EPIC simulation (far right) produces dynamic reconnection process with a chain of islands and stronger out of plane magnetic field (adapted after [7]).

References

1. Jordanova, V. K., S. Zaharia, and D. T. Welling. Comparative study of ring current development using empirical, dipolar, and self-consistent magnetic field simulations. 2010. Journal of Geophysical Research. doi:10.1029/2010JA015671 (115): A00J11.
2. Zaharia, S., V. K. Jordanova, D. T. Welling, and G. Tóth. Self-consistent inner magnetosphere simulation driven by a global MHD model. 2010. Journal of Geophysical Research. doi:10.1029/2010JA015915 (115): A12228.

-
3. Powell, K. G., P. L. Roe, T. J. Linde, T. I. Gombosi, and D. L. De Zeeuw. A solution-adaptive upwind scheme for ideal magnetohydrodynamics. 1999. *Journal of Computational Physics*. 154: 284.
 4. Tóth, G., B. van der Holst, I. V. Sokolov, D. L. De Zeeuw, and T. I. Gombosi et al.. Adaptive numerical algorithms in space weather modeling. 2012. *Journal of Computational Physics*. 231: 870.
 5. Ridley, A., T. Gombosi, and D. L. De Zeeuw. Ionospheric control of the magnetosphere: conductance. 2004. *Annales Geophysicae*. 22: 567.
 6. Yu, Y., V. K. Jordanova, D. T. Welling, B. Larsen, S. G. Claudepierre, and C. Kletzing. The role of ring current particle injections: global simulations and Van Allen Probes observations during 17 March 2013 storm. 2014. *Geophysical Research Letters*. doi:10.1002/2014GL059322 (41): 1126.
 7. Daldorff, L., G. Tóth, T. I. Gombosi, G. Lapenta, J. Amaya, S. Markidis, and J. U. Brackbill. Two-way coupling of a global Hall magnetohydrodynamics model with a local implicit Particle-in-Cell model. 2014. *Journal of Computational Physics*. 268: 236.

Publications

- Daldorff, L., G. Tóth, T. I. Gombosi, G. Lapenta, J. Amaya, S. Markidis, and J. U. Brackbill. Two-way coupling of a global Hall magnetohydrodynamics model with a local implicit Particle-in-Cell model. 2014. *Journal of Computational Physics*. 268: 236.
- Yu, Y., V. K. Jordanova, D. T. Welling, B. Larsen, S. G. Claudepierre, and C. Kletzing. The role of ring current particle injections: global simulations and Van Allen Probes observations during 17 March 2013 storm. 2014. *Geophysical Research Letters*. doi:10.1002/2014GL059322 (41): 1126.

The World's First Drought and Insect Caused Global Tree Mortality Monitoring System

Chonggang Xu
20130733ECR

Introduction

The critical urgency of forecasting climate impacts and feedbacks makes understanding, quantifying, and predicting terrestrial carbon balance and subsequent climate impacts one of the greatest science challenges currently facing the world. The real-time monitoring systems for dominant types of disturbances will provide a key foundation for our understanding of global carbon balance. We currently already have fire-burned area monitoring system and comprehensive land-use change database; however, there is no global monitoring system of drought/insect-caused vegetation mortality, which could be at similar magnitude of fire-caused tree mortality. Armed with the world's leading capability in dynamic vegetation modeling and tree mortality research, we propose to develop the world's first automated global drought/insect-caused tree mortality monitoring system. The mortality monitoring system is developed based on the fusion of different sources of information including real-time mortality signal from remote sensing imagery, vegetation change information simulated from a vegetation dynamics model, radiative transfer and reflectance information from a forest reflectance model, and different sources of background information from forest inventory and remote sensing products. The fusion of different sources of information makes it feasible for the first time in the world to accurately quantify tree mortality using Moderate Resolution Imaging Spectroradiometer (MODIS) imagery from NASA, which is a common remote sensing tool for monitoring earth system processes globally. This detailed tree mortality quantification has never been possible by analyzing MODIS image alone. The successful development of our monitoring system will represent an enormous leap forward in our understanding of terrestrial carbon feedback to atmosphere, which is a key area of climatic change re-search in LANL's mission to understand and predict the impacts of global energy demand.

Benefit to National Security Missions

The development of the world's first insect-caused tree mortality monitoring system will represent an enormous step forward in our understanding of terrestrial carbon feedback to atmosphere, which is a key area of climatic change research in LANL's mission to mitigate the impacts of global energy demand. It can help DOE Office of Science build a global tree mortality database used for dynamic global vegetation model benchmarking, a key area that DOE Office of Science is developing through the International Land Model Benchmarking Project. The data generated through this project can be used to substantially improve tree mortality prediction in the DOE-sponsored Community Land Model (CLM) and thus improve global climate predictions.

Progress

We have made progress in four areas toward our final deliverables of SW tree mortality detection. We have produced about 10 related publications (published, in review or in prep).

First, we have developed a new method to detect tree mortality events and attribute an agent of mortality. The method uses Landsat time series data and multiple vegetative indices to identify mortality events in the conifer forests of the Sangre de Cristo and Jemez Mountains in northern New Mexico. Fire-, insect-, and drought-induced mortality were detected on an annual basis between 1993 and 2012. This method has been tested using older Landsat data (Landsat 4), and across the southwestern US using both Landsat and MODIS satellite imagery.

Second, the ED-FRT tree mortality monitoring system has been tested using an extended data set that encompasses the TA-51 site and covers a total of nine km². Preliminary tests indicate some shortcomings within the current version of the model (e.g., Misregistration of the

reflectance data and the lack of variation in the ensemble runs). We are now working on it to improve the simulation accuracy.

Third, to improve the accuracy of mortality prediction our vegetation model, ED, we have developed a plant hydraulic model, which has been evaluated against observations from the Sevilleta LTER site and TA51. With the improved model, we have made predictions of pinon and juniper mortality for the SW in next 100 years.

Finally, we have conducted a comprehensive sensitivity analysis for the ED model to identify key model parameters that contributes most to the tree mortality prediction. This helps to target the most important components for both the ED-FRT monitoring system and the future field measurements.

For FY15, our goal is to derive the carbon loss for the US Southwest using the developed disturbance detection and attribution system and the ED-FRT tree mortality quantification system. Specifically, we plan the following three tasks.

First, apply the disturbance detection and attribution system for the MODIS images from 2000-2013. Second, apply the ED-FRT tree mortality quantification system for areas identified as drought caused tree mortality. Third, manuscript writing for 3 papers including 1) ED-FRT on TA51; 2) the disturbance detection and attribution system for northern New Mexico; and 3) the tree mortality quantification for southwest.

Conclusion

The success of the project will generate two critical products for global carbon cycle assessment and Earth system model simulation. First, we will fully develop and test world's first insect/drought-caused global tree mortality monitoring system through the coupling of a dynamic vegetation model, a light reflectance and transmittance model, and real-time remote sensing observations. Second, tree mortality database for build for New Mexico, Colorado and Western Australia with estimated carbon loss during the 2000-2012 period will be developed using the our developed monitoring system, which will be used for assessing regional simulations using the DOE-sponsored Community Land Model.

Publications

Adam, H., P. William, C. Xu, S. Rausher, and N. McDowell. Empirical and process-based approaches to climate-induced forest mortality models. 2013. *Frontiers in Functional Plant Ecology*. : 438.

McDowell, N., N. Coops, W. Anderegg, P. Beck, J. Chambers, C. Gangadogomage, J. Hicke, and C. Xu. How global satellite monitoring improves our knowledge of vegetation disturbances. To appear in *Trend in plant sciences*.

McDowell, N., P. William, and C. Xu. Consistent predictions of conifer loss due to chronic temperature rise. *Nature Climatic Change*.

Xu, C.. Decoupling correlated and uncorrelated uncertainty contributions for nonlinear models. 2013. *Applied Mathematical Modelling*. 37: 9950–9969.

Xu, C., J. Muss, and N. McDowell. Uncertainty and Sensitivity Analysis for a tree mortality quantification system. Presented at IUFRO 2014 World congress. (Salt Lake City, 5-11 Oct, 2014).

Xu, C., R. Fisher, J. Muss, and N. McDowell. Uncertainty and Sensitivity Analysis for Process-based Tree Mortality Modelling. Invited presentation at ECOLOGICAL ASSOCIATION OF AMERICA 2013. (Minneapolis, 8-13 AGU 2013).

Xu, C., R. Fisher, N. McDowell, and S. Sevanto. Our Limited Ability to Predict Vegetation Responses to Water Stress. 2013. *New Phytologist*. 200 (2): 8.

Xu, C., and M. Chen. Application of Remote Sensing in Ecosystem and Landscape Modeling. 2013. In *Remote Sensing of Natural Resources*. Edited by Wang, G., p. 173. Florida: CRC Press.

From Troposphere to Ionosphere: How Much do Thunderstorms Disturb the Total Electron Distribution?

Erin H. Lay
20130737ECR

Introduction

The ionosphere is a high-density layer of plasma through which all satellite-detected natural and man-made electromagnetic signals from the Earth's surface must pass. Similar to dispersion of light by transparent solids, significant perturbations in the ionospheric plasma electrons disrupt electromagnetic signals. Variation in ionospheric plasma has traditionally been attributed to changes in geomagnetic activity (space weather). Only recently, the ionospheric community has begun to realize that tropospheric thunderstorms (below ~12 km) could have a significant effect on the ionospheric plasma by the following mechanism: when the updraft in a thunderstorm lifts the top of the cloud above the tropopause (altitude of a temperature inversion), the cloud can begin oscillating about that altitude for tens of minutes, producing a neutral pressure wave, called an atmospheric gravity wave (AGW), with periods of tens of minutes to hours. The goal of this project is to quantify and characterize the ionospheric response to thunderstorm activity, and to determine the mechanisms and magnitude of such coupling. This study is the first empirical analysis comparing ionospheric fluctuations in the peak plasma layer to underlying thunderstorms. For the first time, we will be able to quantify and interpret the spatial extent and dynamic evolution F-layer ionospheric disturbances due to thunderstorm pressure waves. This is of extreme importance for understanding and predicting ionospheric disruption of satellite communications, GPS geolocation signals, and electromagnetic signals such as EMP that are an important part of the Lab's national security mission.

Benefit to National Security Missions

Contribution to Remote Sensing for Nuclear Nonproliferation and Counterproliferation: Significant perturbations in the ionospheric plasma electrons disrupt electromagnetic signals, such as electromagnetic pulses (EMP) that are a key signature of nuclear detonation.

Better understanding of ionospheric disturbances near thunderstorms will improve EMP location accuracy and discrimination between various impulsive sources.

Contribution to Space Science: We will empirically study a new phenomenon for the first time in which atmospheric pressure waves from thunderstorms can significantly disturb the electron distribution in the ionosphere above the storms. Variation in ionospheric plasma has traditionally been attributed to changes in geomagnetic activity (space weather). Only recently, the ionospheric community has begun to realize that tropospheric thunderstorms (below ~12 km) could have a significant effect on ionospheric plasma. This study will provide basic scientific evidence of the relative importance of thunderstorm effects on the ionospheric behavior.

Other contributions: Understanding and predicting ionospheric variations is of importance in understanding disruption of satellite communications, GPS (Global Positioning System) geolocation signals, and electromagnetic signals such as EMP.

Progress

1. Developed data analysis tools for freely-available measurements of total electron content made by Global Positioning System ground receivers. These tools will be useful to the lab for any future ionospheric projects involving total electron content measurements.
2. Identified storms in the Los Alamos Sferic Array lightning database with significant lower ionospheric perturbations.
3. Analyzed several case studies (radar, lightning, and GPS TEC data) of Great Plains storms to determine the properties of thunderstorms with significant lower ionospheric perturbations (i.e. spatial size, height, lightning activity).
4. Performed statistical analysis to correlate upper

-
- ionospheric fluctuations and lower ionospheric perturbations associated with thunderstorm activity.
5. Studied associated acoustic wave variations in upper ionosphere.
 6. Journal article accepted in Journal of Geophysical Research Letters regarding ionospheric perturbations near and above thunderstorms.
 7. Started writing second journal article to be submitted to Nature Geoscience regarding acoustic waves in the ionosphere near thunderstorms.
 8. Presented results at American Geophysical Union Fall meeting and International Conference on Atmospheric Electricity.

Future Work

Main task/goal

Characterize and classify the upper ionospheric response to lower ionospheric disturbances detected using a regional lightning detection network and extend understanding to a global scale.

Sub-tasks/goals

- Begin global case studies of thunderstorms and ionospheric disturbances. Specific regions for analysis include Brazil and Japan. Global TEC measurements have already been obtained for those regions.
- Write up analysis of case studies of storms in the Los Alamos Sferic Array lightning database with significant lower ionospheric perturbations associated with upper ionospheric disturbances.
- Complete statistical analysis of correlational study between upper ionospheric fluctuations and lower ionospheric perturbations associated with thunderstorm activity and write results in a peer-reviewed journal article.

Conclusion

Our goals for this project are as follows:

1. Characterize spatial size, magnitude, and temporal evolution of ionospheric perturbations related to nearby thunderstorms on a regional scale, and how they vary with thunderstorm properties (i.e. size, height, lightning activity).
2. Characterize the magnitude and spatial extent of troposphere/ionosphere coupling on a global scale as a function of geomagnetic latitude.

Impact

The findings from this study will be used to test and evaluate existing atmospheric gravity wave models, enabling us to distill and discover the physical processes responsible for energy and mass transport between the D-layer and

F-layer, and to better now-cast and forecast ionospheric disturbances.

Publications

Lay, E. H., X. M. Shao, and A. R. Jacobson. D region electron profiles observed with substantial spatial and temporal change near thunderstorms. *Journal of Geophysical Research: Space Physics*. 119 (6): 4916.

Lay, E. H., X. M. Shao, and C. S. Carrano. Variation in total electron content above large thunderstorms. 2013. *Geophysical Research Letters*. 40: 1945.

Understanding The Catalytic Conversion of Oligosaccharides to Fuels and Chemical Feedstocks

Andrew Sutton
20130757ECR

Introduction

A procedure to produce branched alkanes containing ten and eleven carbon atoms from starch in two steps using mild acidic conditions with lanthanide and palladium catalysts is known. The reaction proceeds well at 200 oC under moderate pressure of H₂ (200 psi); however, the mechanism and the identity of any reaction intermediates are unknown. If the steps involved in this general reaction can be better understood, routes that obviate the need for expensive catalysts as well as the use of ambient reaction conditions might be achievable.

Benefit to National Security Missions

The work to be carried out develops the understanding of fundamental chemical reactions (i.e. Fundamental Chemistry Mission) with direct relevance to biomass derived substrates to produce fuels and chemical feedstocks. Development of competitive alternative energy sources and feedstocks directly impacts our national security mission.

Progress

The complete mechanism has been elucidated for a model system and this has revealed a key intermediate that is pivotal for the hydrodeoxygenation mechanism to proceed via a lower energy input. This is a very important discovery and we have a paper ready for submission to the Journal of the American Chemical Society detailing this work. We have also started looking at more complex mechanisms and they should be ready for publication shortly.

Future Work

The mechanistic studies are on-going and proceeding well. We are currently in the process of writing three manuscripts for publications. Further development of more complicated reaction schemes will be completed.

Conclusion

We expect to gain a more detailed understanding of hydrodeoxygenation reaction mechanisms involved in alkane production from biomass and to develop an insight into potential new catalysts for performing these transformations.

Publications

Huegle, T., and A. D. Sutton. Selective conversion of biomass to alkanes at 120 oC. TBD.

King, A. E., T. J. Brooks, Y. Tian, E. R. Batista, and A. D. Sutton. Understanding Ketone Hydrodeoxygenation for the Production of Fuels and feedstocks From Biomass. TBD.

Deciphering Nature's Chemical Toolbox: Decoding the Logic of Biosynthetic Assembly Lines

Alexander Koglin
20140624ECR

Introduction

The overarching goal of this project is to support the biosecurity mission of LANL in defeating biothreats due to drug-resistant bacteria and viruses and confront the accelerating development of antibiotic resistance by identifying novel bioactive compounds. This project focuses on the identification of new biosynthetic clusters that produce novel natural products with new chemical properties (chemotypes) to create a compound database for drug development and to decipher the logic of natural product biosynthesis. Those compounds have the potential to be developed into highly effective antibacterial treatments while being immune to current resistance mechanisms, since pathogenic bacterial strains have not been exposed to those compounds.

Genetic and enzymatic studies provide insight of isolated enzymatic functions in natural product biosynthesis, but have not led to new strategies to discover novel natural products biosynthesized by complex enzyme assemblies. Bioinformatics and structural studies are providing insight of three-dimensional folding and selective protein complex formation processes of key enzymes essential for the formation of biosynthetic clusters that produce medically relevant compounds. The unique and not-yet understood spontaneous self-assembly of these enzymes into clusters defines the very selective biosynthesis of all secondary metabolites of which only an estimated 0.1% have been identified so far. Once understood, known biosynthetic complexes can then be engineered to produce new drugs or lead to an efficient identification of new enzymatic assembly lines in vast genome data and isolation of their products that are novel drug leads.

Benefit to National Security Missions

New antibacterial and antiviral treatment options are urgently needed to reduce the threat to public health. The accelerating development of drug resistance in pathogens and its impact on lethality rates is widely

discussed by several funding agencies (incl. HHS, DARPA, BARDA, DTRA, DOD), in scientific press releases and among general public press outlets.

This project is directly related to LANL's missions in Global Security, Biothreat Reduction, and in alignment with the National Security goal of LANL's Bioscience Division. It addresses Priority Area 1 of the Complex Natural and Engineered Systems focus area. Specifically, the ability to decode the biosynthetic logic will accelerate the field of synthetic and systems biology and allow for efficient engineering of drug candidates. This project supports LANL public health mission (Homeland Security Act 2002, DOE Strategic Plan 2011, Public Health Security and Bioterrorism Preparedness and Response Act 2002) as well as its mission in global threat reduction. It also has direct appeal to WFO sponsors, as expressed in ongoing interests by DTRA to develop countermeasures for natural and man-made biothreats. It will both leverage and strengthen LANL's capabilities in computing, genomic and biosynthetic research. We will keep program managers in Global Security (Science of Signatures), DTRA and DOE BES programs apprised of the results of our research so that we can develop future funding for this effort.

Progress

This project focuses on methods to identify genes coding for new biosynthetic enzyme clusters that produce bioactive metabolites with new chemical properties (chemotypes) in genetic information of bacteria, fungi and plants, and to predict the chemical composition or chemical structure of these biosynthesized natural products based on their encoding. It describes a "Genome-to-Drug" discovery route with the goal to create a searchable database of all known and newly identified enzyme clusters and produced compounds for drug development and to decipher the logic of enzyme cluster formation. Natural products represent the class of small bioactive

molecules that are widely applied as antibacterial, antiviral, antitumor, antifungal, immunosuppressant and analgesic drugs. The search for new antibacterial and antiviral drugs supports the biosecurity mission of LANL and other federal government agencies as reflected in numerous recently issued press releases, several research funding announcements.

Since the start of this project (April 2014), we have been collecting, characterizing and depositing protein sequences, enzyme function and structural data in a library of biosynthetic clusters and a library of produced medicinal relevant natural products. First successes were demonstrated with the identification of 19,500 new biosynthetic gene clusters in GENBANK-deposited bacterial and fungal genomes. In addition, 250 recently sequenced genomes have been made available by a federal agency. This collection represents the initial set to develop algorithms to predict the protein complex assembly and the chemical structure of the produced bioactive compounds.

We programmed a searchable database with a graphical user interface that connects strain and genome information with cluster peptide sequences and structural information of the associated natural product of publicly available bacterial systems (GENBANK). We continue to expand the number of entries by including the NORINE and Merck Natural Product libraries to further improve the consistency of structural motifs used for our search algorithm and to enable a reliable prediction of the assembly orders in biosynthetic clusters. We developed a file format that is a one-cluster-per-file setup to allow cross-strain searches and alignments to identify similarity in biosynthetic processing of different natural products in different strains. This further helps to identify events of horizontal gene transfer between species and across strain families.

In addition to previously described recognition motifs (e.g. the phosphopantetheinylation site of thiolation (T) domains or the substrate recognition sites of adenylation (A) domains) in NRPS clusters, we identified short peptide sequence motifs that show high sequence similarity in all domains of a biosynthetic module in case the same substrate is processed. Homology modeling of T, A and condensations (C) domains revealed that these motifs are located on the surfaces of domains and proteins and seem to be highly conserved in their charge distribution if one particular building block is incorporated into the growing product chain. So far, these structural motifs seem to be consistently located at the interfaces of domains of an isolated module and at the proposed interfaces to neighboring modules. The identification of conserved peptide sequences, among all domains of one biosynthetic module

that correspond to the processed substrate of this biosynthetic unit suggests that a quality control mechanism to ensure the correct biosynthesis of natural products is embedded within the peptide sequence of natural product assembly lines. Although it seems necessary to ensure the correct biosynthesis of bioactive compounds, a proofreading mechanism has not been previously proposed. If we can consistently prove this hypothesis for all incorporated substrate building blocks and for in-trans active tailoring enzymes, we will be able to predict the protein complex formation of a biosynthetic module, even for genetically distributed domains, and its clustering order with neighboring modules into biosynthetically active assembly lines. In turn, this will allow prediction of the biosynthetic processing order of a natural product along its assembly line, since these clusters work in a step-by-step mechanism, and will enable us to make assumptions about the chemical structure of a natural product solely based on its genetic encoding.

We will continue our search by analyzing biosynthetic clusters from bacteria/fungi and plants. We are confident that the generated information of bacterial, fungal and plant biosynthetic systems will enable identification of new natural products and guide an informed isolation of those newly identified compounds based on predicted chemical composition and structure.

Future Work

Natural products represent the class of small bioactive molecules that are widely applied as antibacterial, antiviral, antitumor, antifungal, immunosuppressant and analgesic drugs. This project focuses on methods to identify genes coding for new biosynthetic enzyme clusters that produce bioactive metabolites with new chemical properties (chemotypes) in genetic information of bacteria, fungi and plants, and to predict the chemical composition or chemical structure of these biosynthesized natural products based on their encoding. This knowledge will allow (1) identification of new drug classes with new physiological properties, and (2) manipulation of these assembly lines to produce specific drugs and/or efficiently manufacture novel and unique metabolites.

In the next funding period, we will continue analyzing vast bacterial and fungal genome data in an automated search algorithm we developed. We will identify and characterize novel natural product assembly lines, continue to complete the database of biosynthetic clusters to allow the identification of common recognition motifs (jigsaw puzzle links). We will continue updating and improving the search algorithm using the new data.

We will also expand the search for relevant biosynthetic clusters and natural products to plant genomes and include those in our created libraries.

We will begin isolation of first, predicted natural products and confirmation of their structure/composition.

Conclusion

This project leads to the identification of biosynthetic clusters in diverse genomes and the informed isolation of novel natural products from strains known to synthesize potent bioactive compounds. We collect and characterize data in a library of diverse biosynthetic clusters and medicinally relevant natural products. This information is the basis to decipher the mechanism of complex self-assembly in natural product biosynthesis, which will reflect in the development of algorithms to predict the chemical structure of natural products based on their genetic encoding.

Identifying, Creating, and Controlling Functional Hotspots in DNA

Boian Alexandrov
20110516ECR

Abstract

In the living cell, the double-stranded DNA molecule experiences natural thermal motions that induce spontaneous openings and re-closings of the double helix known as “DNA breathing,” or “DNA bubbles.” The genomic locations that demonstrate an enhanced local breathing (usually situated at regulatory sites) have been called nonlinear vibrational hotspots of the DNA. The local propensity for breathing, i.e., the density and strength of the local DNA hotspots are related to the DNA stability and flexibility that play a key role in DNA biological functions such as transcription and replication. Our research shows that DNA breathing is directly associated with the reading of the genetic code, i.e. with the transcription as well as with DNA-protein interactions, and participates in genetic disease mechanisms. We developed a new computation tool for prediction and modification of the strength of DNA hotspots. We correlated our predictions with genomic data obtained by others, and we also demonstrated and experimentally verified the ability of our tool to make predictions. Specifically, we have designed various regulatory DNA sites, and, by changing the strength of DNA hotspots situated in these sites, we changed their functions and checked experimentally that these modifications are changing the corresponding functions according to our predictions. Additionally, we have experimentally demonstrated, for the first time, that by affecting DNA breathing, electromagnetic terahertz radiation can influence gene expression and can be used for stem cell reprogramming.

Background and Research Objectives

The structural stability and functional properties of biomacromolecules are primarily governed by hydrogen bonds (H-bonds). The vibrational frequencies of intramolecular and intermolecular H-bond's are in the terahertz (THz) range. The H-bonds are much weaker than covalent bonds, and that is why biomacromolecules (at physiological temperature) experience slow conformational motion resulting from inherent thermal fluctuations.

Thus, the double-stranded (ds)DNA experiences thermal motions that spontaneously induce local openings and re-closings of the helix (i.e., “DNA breathing” or “DNA bubbles”). The local genomic propensity for DNA breathing is interrelated with its stability and flexibility, which play important roles in cellular gene expression and transcription.

In general, the cellular transcription (i.e., the reading of the genetic code and therefore the production of all the proteins and lipids by the cell) is controlled by various cellular proteins (transcription factors), whose bindings to DNA can enhance or suppress the process. It was established that some transcriptional start sites (TSSs) and transcription-factor-binding sites (TFBSs) display an enhanced breathing, associated with prolonged transient openings of the DNA double helix (bubbles). The genomic locations (usually situated at genomic regulatory sites, such as core promoters) that demonstrate an enhanced breathing have been called nonlinear vibrational hotspots of the DNA. Further, we have demonstrated theoretically that an exposure to a prolonged THz radiation can resonantly induce such DNA hotspots, which can potentially influence the local breathing, and hence the gene expression and cellular function.

Scientific Approach and Accomplishments Computational prediction of promoters and the transcription start sites (hotspots=TSSs)

We developed a new promoter prediction protocol that exploits structural and motif-based DNA characteristics together with the local breathing dynamics of the double helix. Our novel recognition algorithm used supervised and unsupervised learning techniques for core promoter recognition on genomic scale. Via our Markov Chain Monte Carlo algorithm, we performed extensive computer simulations of the DNA breathing dynamics of the following genomic sequences: 30,000 core promoters (all the human genomic promoters of the protein coding genes), 30,000 exons, and 30,000 non-promoters

- total 107 base pairs. We demonstrated that adding DNA breathing dynamics characteristics to currently used recognition characteristics and applying modern machine learning methods leads toward a general and more accurate genomic-scale promoter prediction in this genomic set.

We applied our prediction method to two newly sequenced phages' genomes, and characterized their promoters and active TSS and TFBSs.

Understanding the mechanisms governing affinity of the transcription factors binding sites and their modifications (hotspots =TFBSs)

We studied DNA breathing dynamics of various trinucleotide repeats sequences (TRS) that represent a common type of genomic DNA motif whose expansion is associated with a large number of human diseases (e. g. Huntington disease, X-syndrome, and many others). We found a novel and notable collective breathing behavior of genomic DNA of tandem TRS, leading to propensity for large local DNA transient openings at physiological temperature. We demonstrated that the patterns of openings of various TRSs depend specifically on their length.

We reported that TRSs interfere with the binding of some of the TF by altering the local DNA breathing (in the proximity of the binding sites). Using our computational framework, we designed a modification of the genomic TATA-box (the famous binding site of the TBP), and showed that we can change the TBP binding by inserting specific TRSs, while the nucleotides where the TBP was in contact with the DNA (i.e., the direct points-of-contact) were left unchanged.

We developed a computational framework for identifying and designing the strength of TF binding sites, based on modeling of the DNA hotspots. The new tool has a novel capability to predict the effects of nucleotide modifications, e.g., DNA-methylation, mismatches, and flanking sequence variations on protein binding in cases where binding is sensitive to DNA conformations. In particular, we investigated in detail the influence of DNA breathing dynamics on the binding of the Fis protein (conserved between *Escherichia coli* and *Salmonella typhimurium*), which is known to bind at highly variable sequences. To test our understanding of how Fis binding is influenced by DNA hotspots we designed computationally various Fis binding sites. Specifically, we designed new mutant DNA sequences, leveraging various nucleotide modifications, such as: mismatches; nucleotide methylations; and base pairs substitutions in DNA segments that are known to interact (or not interact) with Fis. In each case, our intention was to make the DNA hotspots either closer to or farther from the typical simulated hotspot of a "strong" Fis bind-

ing site. Our predictions were validated by electrophoretic mobility shift assay (EMSA) experiments – in vitro, and by bioinformatic analysis of all known Fis binding sites - in vivo.

Applying our new TF binding-prediction protocol, we studied the effect of inherited single-base-pair variations, i.e., of single nucleotide polymorphisms (SNPs), implicated in cognitive deficit in schizophrenia in a cohort of 1200 patients. We found experimental evidence that changes in DNA breathing dynamics, caused by a few SNPs influence binding of specific TFs by long-range effects and hence gene expression that points to two adjacent promoter SNPs as the functional variants associated with schizophrenia. In particular, our simulations of DNA hotspots significant sequence effects of specific SNPs on the local breathing dynamics of DNA, while EMSA and transcription (RT-PCR) experiments confirmed the conclusions from our simulations.

By using site-specific chromatin immunoprecipitations, we applied our TF computational framework to derive a specific DNA breathing profile of the transcription factor YY1 binding sites in cells. The ubiquitous TF YY1 has a fundamental role in essential biological processes by activating, initiating or repressing transcription depending upon the sequence context it binds. We found that the genomic flanking sequence variations and single nucleotide polymorphisms may exert long-range effects on DNA breathing dynamics and to predetermine in this way the YY1 binding.

Modifying cellular gene expression via THz irradiation (modification/creation of DNA hotspots by THz irradiation)

We evaluated cellular response of mesenchymal mouse stem cells exposed to a broadband THz radiation. After designing the experiments, we conducted the irradiations and performed: mRNA extraction, gene chip statistical survey, and quantitative real time polymerase chain reaction (Q-PCR) experiments, as well as computational analysis. We found that an extended (6 hours) exposure to broad-spectrum terahertz radiation results in specific changes in gene expression. Our findings suggested that the prolong terahertz irradiation accelerates cell differentiation (cell reprogramming) toward the adipose phenotype by activating the transcription factor peroxisome proliferator-activated receptor gamma (PPARG). Our molecular dynamics computer simulations indicated that the local breathing dynamics of the PPARG promoter DNA coincides with the gene specific response to the THz radiation. Hence, we argued that THz radiation could be a potential tool for cellular reprogramming.

We investigated theoretically the physical conditions of

DNA-bubble appearances in a THz field. We calculated the nonlinear response manifolds for the period T -solutions and the period-doubled $2T$ -solutions of the DNA nonlinear vibrations where T is the period of the external THz field. We demonstrated that the period-doubled breathers (DNA bubbles) appear naturally in a THz field, even if the amplitude (A) of the external field is very small, $|A| \sim 0$. We showed that these period-doubled breathers arise from the multistability overlap between various stages of the Feigenbaum period-doubling cascades in the non-linear potential of the DNA hydrogen bonds.

We study proliferation of electromagnetic waves (EM) in double-periodic medium that is periodic in space and in time. The time-periodicity can be achieved by irradiating the medium with an EM (e.g. THz radiation) source changing in this way its dielectric constant periodically. We found new and exotic solutions of the spectrum of EM in such media, and possible resonances caused by the double-periodicity and eventual incommensurability between the space and time periods.

To understand the connection between THz radiation and DNA dynamics, we studied the effects of the anharmonic strand-separation dynamics of double-stranded DNA on the infrared spectra of the intramolecular base-pairing hydrogen bonds. Using the extended Peyrard-Bishop-Dauxois model for the DNA breathing dynamics coupled with the Lippincott-Schroeder potential for N-H...N and N-H...O coupled with the Lippincott-Schroeder potential for N-H...N and N-H...O hydrogen bonding, inserted in the Schrodinger equation, we identify a high frequency (~ 96 THz) feature in the breathing DNA infrared spectra. We show that this sharp peak arises as a result of the anharmonic base pair breathing dynamics of DNA. In addition, we study the effects of friction on the infrared spectra. For higher temperatures (~ 300 K), where the anharmonicity of DNA dynamics is pronounced, the high frequency peak is always present irrespective of the friction strength.

We performed a large series of THz irradiations on sets of mesenchymal mouse stem cell cultures in a different time point of their development. After the irradiation we leveraged again mRNA extraction, gene chip statistical surveys, and quantitative real time polymerase chain reaction (Q-PCR) experiments. We repeated our previous experimental results but we observed that the level on the effect depends on the level of stem cells' differentiation. Additionally we executed a detailed statistical analysis of the obtained experimental data. Specifically, we analyzed the gene expression data from 18 gene chip micro-assays (chosen for whole-genome mouse expression profile), and additionally the RT-PCR data obtained for 23 selected genes, from the irradiation of the cellular cultures irradiated by

two different terahertz sources - one with single frequency (SF) and the other with broadband frequency beams, for 2 hours and for 12 hours. We performed simulations and correlated DNA breathing of the core promoters of the found upregulated genes. The insignificant differential expression of heat shock and stress related genes as well as our temperature measurements imply a non-thermal response. The microarray survey and RT-PCR experiments demonstrate that at different irradiation conditions distinct groups of genes are activated. Stem cells irradiated for 12 hours with the broadband THz source exhibit an accelerated differentiation toward adipose phenotype, while the 2-hour (broadband or SF) irradiation affects genes transcriptionally active in pluripotent stem cells. Phenotypic and gene expression differences suggest that the THz effect depends on irradiation parameters such as duration and type of THz source, and on the level of stem cell differentiation. We propose that TH radiation has potential for non-contact control of cellular gene expression and for the regeneration medicine.

Our results have been published in 11 peer-reviewed articles, one book-paragraph, and have been reported on 11 conferences and workshops (with 4 invited talks). We filled out one disclosure agreement in the LANL IDEA. Our efforts have been internationally recognized, and we received a Senior Research Fellowship at Durham, UK, funded by the EU.

Impact on National Missions

Our accomplishments support LANL and DOE interests in genomic studies, development of modern statistical learning computational tools, and advanced knowledge on cell biological functions of the complex systems. The research is directly aligned with LANL's and DOE's complex biological systems priority in synthetic biology, as it aspires to design, construct, and manage "biological functions/systems that are more efficient/effective in their applications."

We believed that we opened a new venue for investigation of the interaction between the THz radiation and living matter and proposed a new way of stem cells non-contact reprogramming. We also developed a tool for prediction of the DNA hotspots leading to novel insights about their role in the protein-DNA binding and in the role of the physico-chemical properties of DNA in the biological function.

Publications

- Alexandrov, B.. DNA Breathing Dynamics, Transcription, Protein-DNA Binding, and THz Radiation, LA-UR-13-26948. Invited presentation at CINT User Conference. (Santa Fe, NM, 2013, 24-26, September).
- Alexandrov, B. S., A. R. Bishop, L. Kalaydjieva, I. S. Kohane, K. O. Rasmussen, A. Usheva, and V. I. Valtchinov. DNA Conformation Dynamics and Human Diseases. 2012. LANL ADTSC Science Highlights 2012, LA-UR 12-20429.
- Alexandrov, B. S., A. R. Bishop, N. Zahariev, and I. Kostadinov. Dispersed stable states spectrum of the wave equation with space-time periodic potential. 2013. *Europhysics Letters*. 103: 50001.
- Alexandrov, B. S., K. O. Rasmussen, A. R. Bishop, A. Usheva, L. B. Alexandrov, S. Chong, Y. Dagon, L. G. Booshehri, C. H. Mielke, M. L. Phipps, J. S. Martinez, H. T. Chen, and G. Rodriguez. Non-thermal effects of terahertz radiation on gene expression in mouse stem cells. 2011. *BIOMEDICAL OPTICS EXPRESS*. 2 (9): 2679.
- Alexandrov, B. S., K. O. Rasmussen, A. R. Bishop, and A. Usheva. Protein-DNA binding and breathing dynamics of DNA. 2013. *JOURNAL OF BIOMOLECULAR STRUCTURE & DYNAMICS*. 31: 49.
- Alexandrov, B. S., M. L. Phipps, L. B. Alexandrov, L. G. Booshehri, A. Erat, J. Zabolotny, C. H. Mielke, H. T. Chen, G. Rodriguez, K. O. Rasmussen, J. S. Martinez, A. R. Bishop, and A. Usheva. Specificity and Heterogeneity of Terahertz Radiation Effect on Gene Expression in Mouse Mesenchymal Stem Cells. 2013. *SCIENTIFIC REPORTS*. 3: -.
- Alexandrov, B. S., V. G. Stanev, A. R. Bishop, and K. O. Rasmussen. Anharmonic dynamics of intramolecular hydrogen bonds driven by DNA breathing. 2012. *PHYSICAL REVIEW E*. 86 (6): -.
- Alexandrov, B. S., V. I. Valtchinov, L. B. Alexandrov, V. Gelev, Y. Dagon, J. Bock, I. S. Kohane, K. O. Rasmussen, A. R. Bishop, and A. Usheva. DNA Dynamics Is Likely to Be a Factor in the Genomic Nucleotide Repeats Expansions Related to Diseases. 2011. *PLOS ONE*. 6 (5): -.
- Alexandrov, B. S., Y. Fukuyo, M. Lange, N. Horikoshi, V. Gelev, K. O. Rasmussen, A. R. Bishop, and A. Usheva. DNA breathing dynamics distinguish binding from non-binding consensus sites for transcription factor YY1 in cells. 2012. *NUCLEIC ACIDS RESEARCH*. 40 (20): 10116.
- Alexandrov, B., A. Bishop, A. Hadik, N. Perecki, and B. Siranosian. Functional phage predictions by DNA dynamics calculations, LA-UR-13-23448. Invited presentation at HHMI - Janelia. (Ashburn, Virginia, United States, 2013-06-05).
- Alexandrov, B., A. R. Bishop, and A. Usheva. THz Radiation Open Doors for Regenerative Medicine, LA-UR-13-29108. Invited presentation at mmWave/Sub-mmWave Applications and Technologies. (Marina del Rey, CA, 2013, 03-06, December).
- Alexandrov, Boian S., Amy L. Bauer, Alan R. Bishop, F. Mu, E. Hong-Geller, K. Nowak-Lovato, Kim Ø. Rasmussen, and Ludmil B. Alexandrov. New Insights into Protein-DNA Binding from Simulations of DNA Breathing Dynamics. 2013. Los Alamos National Laboratory Associate Directorate for Theory, Simulation, and Computation (ADTSC) LA-UR 13-20839.
- Bishop, A. R., K. O. Rasmussen, A. Usheva, and B. S. Alexandrov. Entropy-Driven Conformations Controlling DNA Functions. 2012. In *Disorder and Strain-Induced Complexity in Functional Materials*, Springer Series in Materials Science. Edited by Kakeshita, T., T. Fukuda, A. Saxena, and A. Planes. Vol. 148, 1 Edition, p. 273. Berlin: Springer.
- Bock, J., Y. Fukuyo, S. Kang, M. L. Phipps, L. B. Alexandrov, K. O. Rasmussen, A. R. Bishop, E. D. Rosen, J. S. Martinez, H. T. Chen, G. Rodriguez, B. S. Alexandrov, and A. Usheva. Mammalian Stem Cells Reprogramming in Response to Terahertz Radiation. 2010. *PLOS ONE*. 5 (12): -.
- Jablensky, A., D. Angelicheva, G. J. Donohoe, M. Cruickshank, D. N. Azmanov, W. D. Morris, C. S. Weickert, K. W. Carter, D. Chandler, B. S. Alexandrov, A. Usheva, B. Morar, P. L. Verbrugghe, A. Filipovska, O. Rackham, A. R. Bishop, K. O. Rasmussen, M. Dragovic, M. Cooper, M. Phillips, J. Badcock, E. Bramon-Bosch, O. P. Almeida, L. Flicker, M. Gill, A. Corvin, S. Macgregor, and L. Kalaydjieva. Promoter Polymorphisms in two Overlapping 6p25 Genes Implicate Mitochondrial Proteins in Cognitive Deficit in Schizophrenia. 2012. *Mol Psychiatry*. 17 (12): 1328.
- Maniadis, P., B. S. Alexandrov, A. R. Bishop, and K. O. Rasmussen. Feigenbaum cascade of discrete breathers in a model of DNA. 2011. *PHYSICAL REVIEW E*. 83 (1): -.
- Nowak-Lovato, K., L. B. Alexandrov, A. Banisadr, A. L. Bauer, A. R. Bishop, A. Usheva, F. P. Mu, E. Hong-Geller, K. O. Rasmussen, W. S. Hlavacek, and B. S. Alexandrov. Binding of Nucleoid-Associated Protein Fis to DNA Is Regulated by DNA Breathing Dynamics. 2013. *PLOS COMPUTATIONAL BIOLOGY*. 9 (1): -.

Understanding Energetic Ion Transport and Loss in Natural and Artificial Radiation Belts at Low Altitudes

Misa Cowee
20120715ECR

Abstract

Energetic ions in natural and artificial radiation belts can cause damage to the civilian and military assets whose orbits intersect those belts. To better predict the threat posed to satellites, we must understand the physical processes, which govern the formation and loss of these radiation belts. One such process is known as magnetic field line curvature (FLC) scattering, and it is found to cause the rapid de-trapping and loss of the inner radiation belt protons during geomagnetic storms. Through test particle simulations, we investigated how the properties of this loss mechanism depend on the proton's energy, velocity, radial position, and geomagnetic activity level. From these results we were able to determine reasons why existing models of FLC scattering induced loss do not agree well with satellite observations. We then developed a new predictive model for FLC scattering induced loss in the inner proton belt that shows very good agreement with the simulation results and is easy to use. We also used the test particle simulations to investigate the potential effects of FLC scattering on ionized fission fragments after a high altitude nuclear explosion. This is important for artificial radiation belt models, which calculate the spatial distribution of the high energy electrons produced by the beta-decay of the fission fragments. We determined that FLC scattering is not a substantial transport mechanism for the ionized fission fragments, but that it could be a substantial loss mechanism if ionized fission fragments are injected at very high altitudes, which they are in current artificial belt models.

Background and Research Objectives

Recent satellite observations indicate that geomagnetic storms can cause energetic protons trapped in the Earth's inner radiation belt to become de-trapped and lost on timescales faster than any known physical processes associated with the radiation belts. Analytic studies indicate that these protons may be rapidly de-trapped and lost because their motion is modified by

sudden changes in the magnetic field during magnetic storms in a process called magnetic "field line curvature" (FLC) scattering. Comparison of observations to the predictions of these various analytic models, however, has yielded discrepancies, which have yet to be explained.

Additionally, satellite observations from the 1960's of the artificial radiation belt produced by beta-decay of fission fragments after the Starfish Prime high altitude nuclear test shot indicated that its artificial radiation belt extended above 10,000 km and persisted for several years, damaging a large fraction of the existing space infrastructure. The spatial extent of this artificial belt was not predicted at the time and has not been explained since; however, it has not yet been tested whether or not the ionized fission fragments could have become de-trapped due to FLC scattering in the HANE-perturbed magnetic fields, allowing them to travel to higher altitudes where they could have subsequently populated the artificial radiation belt.

For the natural radiation belts, our first goal of this project was to carry out a simulation study to better understand the physics of the FLC scattering loss mechanism and the magnetospheric conditions that cause it, and determine why the existing analytic models did not agree well with observations. Our second goal was to use the simulation results to develop a new model of FLC scattering induced de-trapping, which could be easily applied as a space weather predictive model for the inner proton belt. Our third goal was to validate our newly developed model by comparing to several observed cases.

Within the time frame of the project we were able to accomplish the first two goals, however we ran out of time before we could do the observational validation. Our simulation results showed that FLC scattering is a viable mechanism to explain the loss of inner belt protons after a geomagnetic storm and the results have helped us to identify reasons for the discrepancies between the

observations and the current analytic model predictions of the inner belt proton structure after geomagnetic storms. We have also developed a new predictive model for inner proton belt de-trapping that depends on the proton's orbital distance, velocity, the magnetic field model, and the geomagnetic activity level.

For the artificial radiation belts, our project goal was to test whether or not FLC scattering of the ionized fission fragments was capable of transporting the debris ions to higher altitudes on rapid timescales. Our first simulation results accomplished this goal, showing that FLC scattering was not a viable mechanism to explain the large spatial extent of the Starfish artificial belt. Although we quickly came to this conclusion, we then realized that we could test another relevant aspect of the problem, and adjusted our goals. Our second goal then became to test whether or not debris ions could be trapped when injected onto magnetic field lines at very high altitudes as is done in several existing artificial belt models. This injection of debris ions is employed in order to produce a match to the observed spatial structure of the artificial belt, but may be unphysically trapping the debris ions.

Scientific Approach and Accomplishments

For this project we developed a particle tracing (test particle) simulation code to follow the motion of energetic ions in the Earth's magnetosphere. In the radiation belts, trapped ions typically exhibit three basic types of motion—they gyrate around magnetic field lines, bounce up and down magnetic field lines and drift around the Earth. Figure 1 (left) shows the trajectory of a hypothetical proton in a trapped orbit, which starts at the green dot and ends at the red dot (combined gyration, bounce and drift motion is seen). The Earth is approximated as the large blue sphere for reference. FLC scattering can occur every time an ion bounces past the equator, and typically manifests in changes in the ion's pitch-angle, α , which is the angle between the magnetic field and the ion's velocity vector. If a trapped ion's pitch-angle is sufficiently decreased in the scattering, then it can end up lost into the atmosphere. Though this change in pitch-angle can be small on a single bounce, because ions can bounce hundreds of times in a typical orbit, the cumulative effect can be large and a large population of previously trapped ions can end up de-trapped and lost to the atmosphere.

Whether or not the ion experiences FLC scattering and is de-trapped depends on its mass (m), charge state (q), energy (E), pitch-angle (α), and the magnetic field topology at its orbit. For example, further from the Earth, the magnetic field lines become more curved at the equator, which favors FLC scattering. This is why FLC scattering is

particularly prevalent during geomagnetic storms, because the magnetic fields become even more curved at these times. FLC scattering happens then because the gradients in the magnetic field experienced by the ion during one gyration as it crosses the equator are non-negligible. In this case, constants of motion cannot be determined, and the ion can exhibit trajectories, which are not predicted by the typical expected (adiabatic) motion. Figure 1 (right) shows the trajectory of a hypothetical proton when it is subject to FLC scattering. Note how the motion is chaotic compared to the trapped orbit in the left panel.

To test the effect of varying initial spatial and velocity distribution and magnetic field model we carried out ensembles of simulations of populations of natural belt protons and artificial belt debris ions. The protons and debris ions were tracked in the simulations until they are either lost or stably trapped. The ions are considered lost if they exit the simulation box (radial distance > 15 Earth radius) or if they enter the atmosphere.

For the natural belts, our simulation results showed good agreement with existing analytic models predictions for the degree of FLC scattering caused by a proton in a single-scattering event (single bounce). However, our results after cumulative scatterings (tens to thousands of bounces) can show significant disagreement with the analytic model predictions. We identified several reasons for this disagreement, mainly in the assumptions made in these analytic models. First, these models assumed that the cumulative behavior could be predicted based on the degree of FLC scattering during the first bounce. We found this assumption led to a significant over-prediction of the loss. Second, these models did not accurately reflect the effect of the proton's gyrophase angle on the scattering. The gyrophase angle is a measure of the clock angle of the proton in the plane of its gyration; for example, as the proton is gyrating around the magnetic field line, the point in its gyration when it is furthest from the earth is at 0 degrees, while the point in its gyration when it is closest to the earth is 180 degrees). The gyrophase angle is important because the gradients in the magnetic field are different at the points in the gyration.

Based on our test particle simulation results, we were able to develop a new analytic model to better predict the FLC scattering induced loss of protons based on their energy, pitch angle, orbit radial distance, and geomagnetic activity level [1]. By applying our new model, we obtain very good agreement with our simulation results for a range of geomagnetic activity levels. Figure 2 shows a comparison of the simulation results (gray line) to the predictions of our new model (yellow) and several other existing models (blue, red, green). Shown are the radial profiles of inner

belt protons (L is a measure of radial distance in units of Earth radius, R_e) for cases of 25 and 100 Mega-electronvolt (MeV) proton energies under different magnetic field models. The geomagnetic activity level is given by the index K_p , where $K_p = 3$ is a moderate storm and $K_p = 6$ is a very strong storm. Thus our model can potentially serve as an easy-to-use and more reliable predictor of inner belt proton loss due to FLC scattering than the previously used models.

For the artificial belts, our simulation results showed that FLC scattering of debris ions was possible but the effects due to the explosion-perturbed magnetic fields would be minimal. Thus, we concluded that FLC scattering could not have been responsible for transporting debris ions to significantly higher altitudes than the burst altitude.

Our test particle simulation results also showed that the common practice in artificial belt models of simply injecting debris ions at high altitudes to produce an artificial belt structure that agrees with observations must consider the effects of FLC scattering [2]. Figure 3 indicates the fates of the debris ions launched in the simulation. FLC scattering may cause debris ions to be lost to the atmosphere (blue areas) or lost outside the simulation box (orange areas). Debris ions that remain trapped on the field lines are indicated in gray. Shown are plots for varying initial debris ion velocity (500, 2000, 4000 km/s), mass (m) and charge state (q). L is a measure of the radial distance in units of Earth radius. We find that some of the debris ions will likely FLC scatter and be lost to the atmosphere or outside the simulation box on timescales of seconds, which does not give them sufficient time to populate the region with beta-decay electrons. This effect is not included in current artificial belt models.

Impact on National Missions

This research directly supports the LANL mission because its results address a gap in modeling space weather. Energetic protons in the inner radiation belt are not currently included in such models, but pose a significant hazard to spacecraft in orbit. Space weather effects on sensors can compromise our Nuclear Detonation Detection (NDD) remote sensing program, so understanding the potential hazard from natural or artificial radiation belts from a High Altitude Nuclear Explosion (HANE) is critical.

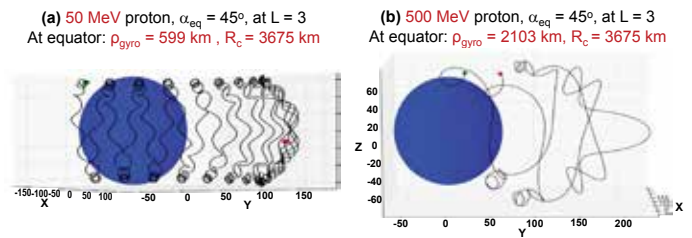

Figure 1. (Left) The trajectory of a hypothetical proton in a trapped orbit which starts at the green dot and ends at the red dot. Combined gyration, bounce and drift motion is seen. (Right) The trajectory of a hypothetical proton when it is subject to FLC scattering. The motion is chaotic compared to the trapped orbit in the left panel. The Earth is approximated as the large blue sphere for reference in both panels.

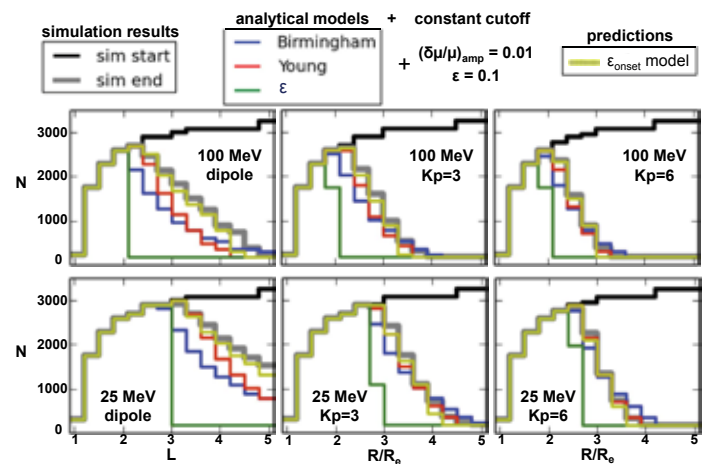

Figure 2. Comparison of the simulation results (gray line) to the predictions of our new model (yellow) and several other existing models (blue, red, green). Shown are the radial profiles of inner belt protons (L is a measure of radial distance in units of Earth radius, R_e) for cases of 25 and 100 MeV proton energies under different magnetic field models. K_p is an index for the geomagnetic activity level where $K_p = 3$ is a moderate storm and $K_p = 6$ is a very strong storm.

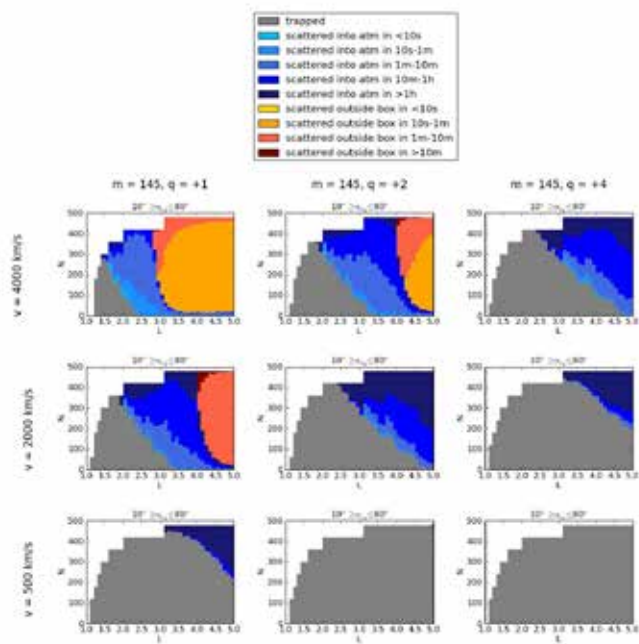

Figure 3. The fates of the debris ions launched in the simulation. Debris ions may be lost to the atmosphere (blue areas) or lost outside the simulation box (orange areas). Debris ions which remain trapped on the field lines are indicated in gray. Shown are results for varying initial debris ion velocity (500, 2000, 4000 km/s), mass (m) and charge state (q). L is a measure of the radial distance in units of Earth radius.

References

1. Tu, W., M. M. Cowee, and K. Liu. Modeling the Loss of Inner Belt Protons by Magnetic Field Line Curvature Scattering. 2014. Journal of Geophysical Research. 119 (7): doi: 10.1002/2014JA019864.
2. Cowee, M. M., and D. Winske. Magnetic field line curvature scattering of debris ions after a HANE. Journal of Radiation Effects Research and Engineering.

Publications

Cowee, M. M., K. Liu, W. Tu, R. H. Friedel, and G. D. Reeves. "Test Particle Simulations of μ -Scattering in the Inner Proton Belt". Presented at American Geophysical Union Fall Meeting 2012. (San Francisco, CA, Dec 3-7, 2012).

Cowee, M. M., W. Tu, and K. Liu. Loss of Inner Radiation Belt Protons due to Magnetic Field Line Curvature Scattering: Test Particle Simulation Results. Presented at American Geophysical Union Fall Meeting. (San Francisco, 9-13 Dec, 2014).

Cowee, M. M., and D. Winske. Magnetic field line curvature scattering of debris ions after a HANE. Presented at Hardened Electronics and Radiation Technology. (Huntsville, AL, 18-21 March 2014).

Cowee, M. M., and D. Winske. Magnetic field line curvature scattering of debris ions after a HANE. Journal of Radiation Effects Research and Engineering.

Tu, W., M. M. Cowee, and K. Liu. "Test particle simulations of field-line-curvature scattering in the inner proton belt". Presented at Geospace Environment Modeling Workshop. (Snowmass, Co, June 16-23, 2013).

Tu, W., M. M. Cowee, and K. Liu. Modeling the loss of inner belt protons by magnetic field line curvature scattering. 2014. Journal of Geophysical Research. 119 (7): doi: 10.1002/2014JA019864.

Construction and Functionalization of Novel Biomimetic Human Liver

Jun Gao

20120716ECR

Abstract

The liver is the largest internal human organ for metabolism, detoxification and protein synthesis. It contains complex microvascular architecture to sustain the high demand of these biological functions. Reconstruction of such an organ in vitro remains challenge in bioengineering. Such in vitro platform can be used to study of liver disease and systemic detoxification. In this proposed study, we utilized microfluidic technology to develop a functional in vitro human liver organ. This in vitro organ system performs normal in vivo liver metabolic and detoxification functions. The optimized platform provides architectures for nutrient and gas exchange. It also allows immune cells and endothelial cells to communicate with liver tissues. The biocompatible hollow fiber networks in the device were used to simulate vasculature. The internal lumen of hollow fibers supported vascular endothelial cell growth to form mono-endothelium, and selectively control the diffusion of secretory factors, nutrients and waste. The external space of the hollow fibers provided an essential support for hepatic cell growth, organization, and differentiation. This resulted a fully developed, functional liver organ.

Background and Research Objectives

Advances in tissue engineering and artificial organ systems are expected to have a major impact on drug discovery, screening, and assessment of efficacy and safety, and to facilitate basic research of cellular and subcellular mechanisms. The ultimate potential of engineered organs will be realized by more complex, powerful, and integrated systems capable of recapitulating inter- and intra-organ signaling and dynamics. Rational design and development of in vitro predictive platforms that support multiple human organ constructs will allow for the systematic, reproducible, and quantitative screening of chemical and biological warfare agents (CBWAs), as well as the pharmacokinetic and pharmacodynamic analysis of medical countermeasures. We have engineered an integrated liver organ platform by coupling microvascu-

lar systems using human cells, hollow fibers, and microfluidic technologies (Figure 1). Our objective is using this platform to recapitulate the biochemical and functional activity of a human liver. This project will provide the accurate simulation of spatial and functional complexity of human liver, and will be amenable to rapid, high-throughput analysis to allow for real-time monitoring of organ viability and pathophysiology. The strength of our approach is the use of multiple advanced technologies to recapitulate the anatomical and functional characteristics of liver organ.

Scientific Approach and Accomplishments

Constructing microfluidic and cartridge platforms: In this study, we developed both small-scale (microfluidic platform) (Figure 1) and large-scale hollow fiber cartridge-based 3-dimensional (3D) liver organs with vascular systems. Our reconstructed liver organ used a 3D hollow-fiber scaffold to support vascular endothelium and liver tissues by mass exchange and oxygenation to support long-term growth and maintenance of normal hepatic metabolic functions. In both of these systems, hollow-fibers served as the capillary system (Figure 2). The medium and endothelial cells were circulated through the hollow fiber lumen by peristaltic pump. The shear stress in the fiber was precisely controlled and relevant to in vivo transmembrane pressures. Compared with non-shear stress condition, we found that the integrated endothelium was formed, and the biological functions of vascular tissue were identical with in vivo condition (Figure 3).

In these platforms, we reconstructed liver tissue in the extracapillary of hollow fibers. The maintenance of differentiated hepatocytic functions in the bioreactor was demonstrated using primary human liver cells. The primary human hepatocytes were used to provide functional activity with low immune responses and have good compatibility with vascular endothelial cells. We have maintained the tissue for one month, and urea syn-

thesis and P450 enzyme's activities were stable (Figure 4). These data suggest that these reconstructed liver tissues can maintain their long-term performance, and can act as alternative model to simulate the hepatocyte metabolism *in vivo*.

Tissue validation: To evaluate the functional metabolic activity of constructed liver tissues to toxic metabolites, we measured trans-epithelial electric resistance, differentiation markers, albumin and urea production, glucose consumption, LDH release and cytochrome P450 enzymatic activities. Our results suggested that both small and large-scale liver platforms demonstrated similar normal hepatic metabolic functions and detoxification activities.

Immune activities: Immune cells and inflammatory cytokines played essential roles during acute liver injury or liver inflammation. The release of chemotactic factors in plasma will affect the vascular endothelial cells and recruit immune cells. In the present study, we introduced human peripheral blood mononuclear cells into the liver microvascular system. β -naphthoflavone was used to initiate liver injury. The cytokine profiles were evaluated using a cytokine array study. We have demonstrated that proinflammatory cytokines associated with macrophages and neutrophil activation was significantly increased. This immune activation is similar to the *in vivo* situation.

In conclusion, our *in vitro* 3D liver organ system is similar in functionality to human *in vivo* liver organ. It can be implemented into a diverse range of clinical, biomedical, pharmaceutical and toxicological applications for long-term functional evaluation of chemical and biological warfare agents. Further, the microfluidic capability established during this study was used to develop other tissues, such as a neuromuscular junction. We also utilized this technology to develop other microfluidic related programs, such as water treatment and radioactive material reduction.

Impact on National Missions

Many Department of Defense (DOD) agencies, including Community Business Development Partners department (CBDP), Defense Threat Reduction Agency (DTRA), and The Joint Science and Technology Office for Chemical and Biological Defense (JSTO-CBD), are seeking innovative countermeasure technologies for chemical and biological defense. Within this area, one major goal is the development of state-of-the-art rapid and effective *in vitro* toxicological platforms to provide an early warning system, reduce and eliminate the threat, and mitigate the effects of CBWAs. To address these needs, our developed liver platform can be used for CBWA toxicology evaluation during accidental exposures and in terrorist attacks. This platform can detect molecular biomarkers, liver metabolic responses, and

changes in liver physiology after threat agent exposure. This tissue platform can also benefit a variety of biological applications, from basic biological sensing to toxicological testing and drug discovery. For biodefense purposes, we envision this platform to be utilized for detection of potential toxic agents for ingestion exposure.

This work can support the Los Alamos National Laboratory (LANL) threat reduction mission and creating viable external funding opportunities. Combining with our skin and lung tissue platform, we are using these complete *in vitro* 3D tissue/organs capability to develop proposals targeting environmental and workplace exposure paradigms.

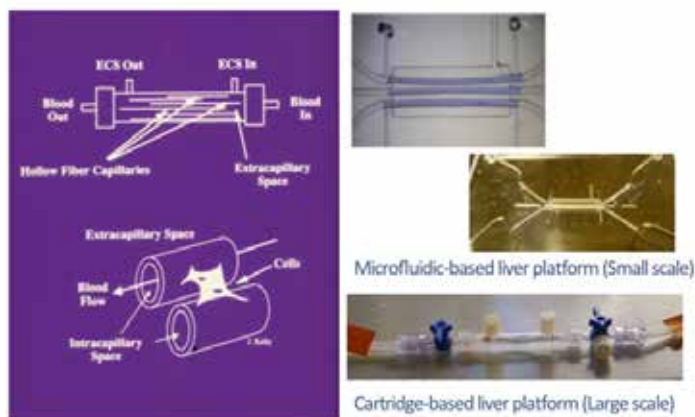

Figure 1. *in vitro* liver organ devices: schematic drawing of device design (Left); Microfluidic based-device (right top) and cartridge based device

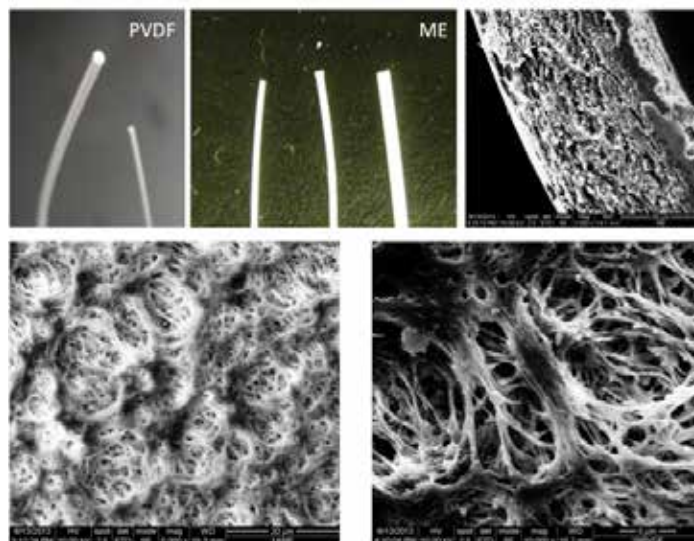

Figure 2. Hollow fibers used for reconstructing vascular tissue. Hollow fibers with different sizes (Top left), cross section of hollow fiber and inner surface of fiber (bottom)

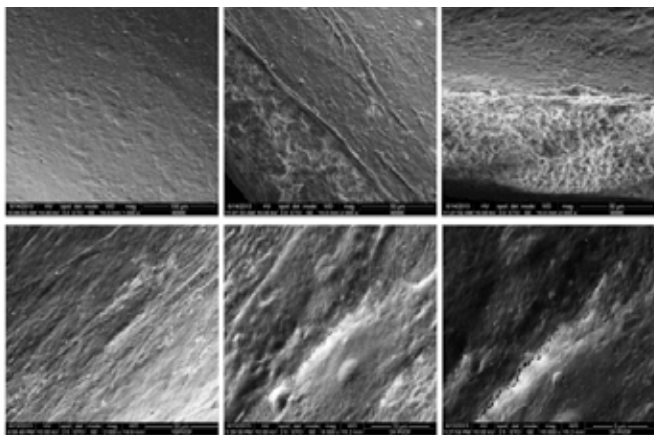

Figure 3. Scanning electron microscope images of differentiated vascular tissues: Top pannel: Differentiated monolayer vascular endothelium; Bottom: High resolution of endothelium with single cell.

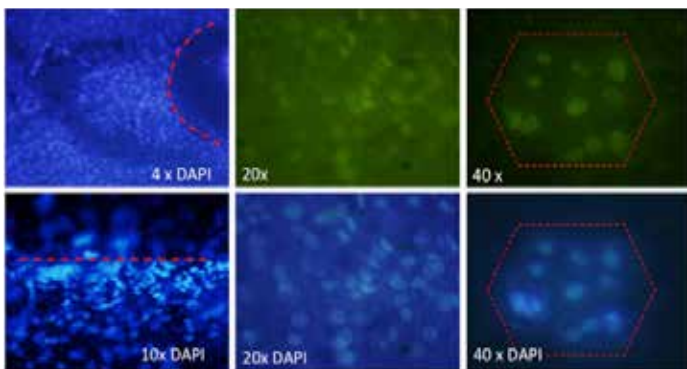

Figure 4. Immunohistochemistry staining of differentiated liver tissues

Publications

Gao, J.. Functional in vitro Biomimetic Human Liver for Toxicological Study . To appear in Lap-on-a-Chip.

Gao, J., and S. Burchiel. incomplete publication data Genotoxic Mechanisms of PAH-induced Immunotoxicity

Gao, J., and S. Burchiel. Genotoxic Mechanisms of PAH-induced Immunotoxicity. To appear in Molecular Immunotoxicology. Edited by Corsini, E. . To appear in Molecular Immunotoxicology. Edited by Corsini, E..

Gao, J., and S. Burchiel. Polycyclic Aromatic Hydrocarbons and the Immune System . To appear in Encyclopedic Reference of Immunotoxicology.

Label-Free Measurement of Single Cells by Impedance Cytometry in a Microfluidic Device

Babetta L. Marrone
20130239ER

Introduction

Single cell analysis is needed for characterizing heterogeneous populations, which is not only important for most applications in the biosciences, but is particularly critical for emergent industries like algae biofuels and global public health. Single cell analysis systems require integration of technologies for counting, positioning, separating, sorting, characterizing, and identifying single cells in a high-throughput manner. Typically, these functions are accomplished using flow cytometry and sorting in a laboratory setting, which requires extensive sample preparation and fluorescent labeling for sensitive detection. Although very effective and highly specific, these approaches do not lend themselves to modern needs in bioenergy or global public health where cost, robustness, speed, and sample throughput are as important as the measurements being performed.

Microfluidics “lab on a chip” technologies hold great promise for the future of single cell analysis in the field. However, as instruments “shrink” it will also be essential to simplify measurements. We will develop a new approach for single cell analysis using impedance sensing on a microfluidic device. We will: 1) Design and construct a microfluidic-scale, impedance sensing device for detection and manipulation of large numbers of single biological particles based on intrinsic properties, without the use of specific labels. 2) Develop new signatures for distinguishing specific cells in context, based on intrinsic properties obtained by impedance sensing; and investigate the cellular sources of these responses. 3) Apply the new approach to solve real-world problems in biological detection using the model system of direct quantification of biomass and lipid productivity during algae cultivation for biofuel production.

The expected outcome of this project is a simplified measurement modality and new set of signatures for investigating and identifying biological particles in real

time. High-impact applications include monitoring biofuel production, and other potential applications in medical diagnostics, biomedical research, pharmaceutical screening, toxicology, and environmental science.

Benefit to National Security Missions

We will develop a new measurement modality and new set of signatures for investigating and identifying biological particles in real time for high-impact applications in biofuel production, as well as medical diagnostics, drug discovery and screening, toxicology testing, and biomedical research. The greatest impact of this simple, label-free, nondestructive approach is that it can be implemented on small, low cost platforms, thus enabling introduction of real-time sensing and measurement technologies into new fields of bioenergy and health care. The work has immediate applications to DOE-EERE programs in renewable energy, replacing petroleum-based fuels with fuel made from algae feedstocks. The work will support automation of algae cultivation systems for biofuel production. Automation will save operating costs, optimizing growth and harvesting schedules to reduce the overall cost of biofuels production. The capability to design and test lab-on-chip devices directly addresses mission needs of the National Institutes of Health (NIH) and the Department of Defense. Both agencies are actively seeking to develop miniaturized sensor devices for biomedical and biosecurity applications in support of National and Global Security mission challenges. Specifically, the work directly addresses translational medicine and global public health missions of NIH by providing a new approach for disease diagnostics that is rapid, simple, and affordable.

Progress

Microfluidic Device Design and Fabrication

1. We are working towards optimizing the design of

the impedance element using COMSOL multiphysics software.

2. We have designed and built a series of soft lithography impedance sensing devices. Coplanar electrodes with width and spacing of 10-20um were found to be unstable and debonded from the glass substrate in about an hours time. A new electrode layering is being implemented. PDMS channels of a variety of widths (50um, 100um, 250um) and depths (25um, 40um, 100um) have also been tested with clogging occurring in the narrow channels severely limiting the lifetime of the device to circa one hour.
3. We are exploring etched glass substrates with opposed side-wall electrodes, which are reported to be more sensitive and more difficult to manufacture using a soft lithography approach. The etched glass substrate may provide a more robust device.
4. A commercially available impedance sensing device has been purchased. This will allow comparison to future devices designed and fabricated in our laboratory.

Impedance Measurements

1. LabView based impedance sensing program was developed and tested. This custom program allows for high speed (thousand particles per second) and multifrequency sample interrogation.
2. Installed a high speed camera and integrated it with the LabView program. Cells that record an impedance event are automatically imaged.
3. Stopped-flow impedance measurements of polystyrene beads, algae cells, and media were conducted.
4. We constrained the design and operating space of the system, giving consideration to the particle sizes and concentrations, the electrode widths, the sample interrogation times, and the probability of particle coincidences.

Cell Separator Devices

1. In Year 1, we demonstrated the ability to separate E. coli bacteria from blood using a continuous flow Surface Acoustic Wave (SAW) separation device. Additional SAW separation devices are being designed and constructed.
2. The acoustic force on a particle depends on its diameter, density and compressibility. We will continue to explore how these intrinsic characteristics can be used to separate cells and measure single-cell properties of interest. For example, independent measurements of cell size, buoyancy, and stiffness permits a cell's responsiveness in an acoustic field to be calculated by application of acoustic theory. These

properties are quite difficult to measure and are typically performed using bulk suspensions. However, the response of an individual cell to an acoustic field (SAW) can be combined with individual cell images to provide distributions of cell size and responsiveness, and their correlations. The ability to access single-cell properties such as responsiveness and size would provide powerful new insights with implications for rapid cell feature detection.

Computational Signature Extraction

We developed a computational approach to identify a small set of intrinsic features that accurately predicted oil/lipid content in algae. The software that we developed is efficient and accurate and requires very little user input. Data on 237 features were collected for 10,000-cell samples from an imaging flow cytometer. Using an innovative genetic algorithm, a set of 13 key features were found to be most informative for quantifying lipid accumulation in algal cells.

FY14 Achievements

Publication. Ai, Y., C. K Sanders, and B. L. Marrone. Separation of E. coli bacteria from Peripheral Blood Mononuclear Cells using Standing Surface Acoustic Waves. *Analytical Chemistry* 85 (19): 9126-9134, 2013. (Web availability: August 23, 2013; In Print: October 1, 2013).

Provisional Patent Application. Marrone, B. L., James E. Coons, and Daniel M. Kalb. Manipulation and detection of cells and droplets in microfluidic devices using Surface Acoustic Waves (SAWS) and impedance sensing. S-129,407 / LAD2012-055-1 (Provisional patent application filed April 16, 2014).

R&D100 Award Nomination. Marrone, B. L., Y. Ai, J. E. Coons, and Team. "Cyto-AMP" Cell Acoustic Manipulation Platform. Submitted May 9, 2014.

Oral Presentation. Munsky, B. L., S. Sellars, C. Sanders, and B. L. Marrone. Automated Label-free Classification of Algal Lipid Accumulation. 4th International Conference on Algal Biomass, Biofuels, and Bioproducts. Santa Fe, NM June 18, 2014.

Invitation to Submit Manuscript. Special Issue of Cytometry, Part A focused on Computational Data Analysis of High Dimensional Cytometry Data. (manuscripts due September 1, 2014).

Future Work

1. Continue to test and apply the prototype microfluidic device that uses SAW (for focusing) and impedance

-
- sensing of cell properties.
2. Continue studies to identify intrinsic features of cells that can be used as candidate signatures in biological applications, using established methods (e.g. imaging flow cytometry). Conclude algae lipid measurement experiment. Work with imaging flow cytometer companies to gain access to flow cytometry data from clinical applications.
 3. Explore classification strategies for simpler devices. Apply advanced classification strategies to consider nonlinear combinations and correlations of features. Release public software for automated signature identification.
 4. Advance the develop the sorting feature of the microfluidic device. Sort cells based on size and another feature as measured without the use of labels by impedance analysis or acoustic contrast. Confirm the measurements by comparison to established methods.
 5. Continue to demonstrate the general applicability of impedance sensing and acoustic cell manipulation in new applications.

tion. Presented at 4th International Conference on Algal Biomass, Biofuels and Bioproducts . (Santa Fe, NM, 15-18, June 2014).

Conclusion

We will develop a device to measure and sort cells, based on signatures which can be detected without labels; and will demonstrate quantitative measurement performance of this device to analyze cell size, lipid content, viability, and other intrinsic features. We will also determine physical cell features that result in impedance or acoustic contrast differences between single cells. The outcome of the project will pave the way for simple, label-free, single cell analysis devices that can be used for many applications, e.g. to automate real-time cell analysis for algae biofuel production; or to bring cell diagnostic capabilities into resource-limited areas of the world.

Publications

Ai, Y., C. K. Sanders, and B. L. Marrone. Separation of *Escherichia coli* bacteria from Peripheral Blood Mononuclear Cells (PBMC) using Standing Surface Acoustic Waves (SSAW). 2013. *Analytical Chemistry*. 85 (19): 9126.

Marrone, B. L.. Flow cytometry in algae biofuels and by-products research. Invited presentation at 4th International Conference on Algal Biomass, Biofuels and Bioproducts. (Santa Fe, NM, 15-18 June, 2014).

Marrone, B. L., Y. Ai, and J. E. Coons. Cyto-AMP Cell Acoustic Manipulation Platform. 2014. R&D 100 Award, 2013 Nomination LA-UR-14-21909.

Munsky, B., S. Sellars, C. Sanders, and B. L. Marrone. Automated label free classification of algal lipid accumula-

Complex Natural & Engineered Systems

Exploratory Research
Continuing Project

A New Hypothesis to Explain the Variability of the Outer Radiation Belt: Can we Predict Post-storm Fluxes of Energetic Electrons Based only on Pre-storm Fluxes of the Lower-energy Population?

Gregory S. Cunningham
20130297ER

Introduction

The primary goal of the proposed work is to test the hypothesis that flux levels of mega-electronvolt (MeV) electrons in the outer belt can be predicted on an event-by-event basis solely as a consequence of electromagnetic waves accelerating low-energy particles that are convected in from the outer magnetosphere. In order to conduct a test of this hypothesis, we need a category of events for which fluxes of MeV electrons in the outer belt are highly depleted so that we can predict their buildup over time due to acceleration of a low-energy source population. We have identified High-Speed Streams (HSS) as meeting this need. Assuming we have an initially-depleted state of the MeV electron population in the outer belt, we must be able to predict the time-evolving distribution of low-energy electrons convected into the outer belt, since the low-energy electrons are the source that will be accelerated to higher energies through diffusion.

The Ring-Current Atmosphere interactions (RAM) code will be used for this purpose, first for HSS events and then for geomagnetic storms. It must be demonstrated that RAM is predictive for HSS events, since RAM has been primarily applied to storms. Finally, given the time-dependent population of low-energy electrons, which acts as a boundary condition for the 3D diffusion code, we must be able to predict event-specific distributions of the amplitude of the electromagnetic waves responsible for diffusing the low-energy particles up to higher energy. We will build an event-specific empirical wave amplitude database using data from the soon-to-be-launched Radiation Belt Storm Probes (RBSP) mission that will, in its own right, result in considerable utility to the magnetospheric science community.

Benefit to National Security Missions

This project will test the hypothesis that fluxes of outer belt energetic electrons after geomagnetic

events can be predicted from knowledge of the low-energy source population prior to the event and electromagnetic wave distributions during the event. In order to test the hypothesis, we will create a new modeling capability that utilizes in-situ measurements of the low-energy source population as a boundary condition for a code that predicts the evolution of the high-energy population. The hypothesis, if proved true, will lay the groundwork for enabling forecasting of space hazards due to energetic electrons in the outer radiation belt hours to days in advance. Such a capability would directly impact NASA's goal to improve our understanding of how the sun impacts the environment in which satellites operate, e.g. the 'Living With a Star' program. The DOD, specifically the Air Force Weather Agency, is tasked with alerting owners of national security assets in space of impending hazards, and so DOD will directly benefit. NOAA, specifically the Space Weather Prediction Center, is tasked with alerting owners of commercial space-based assets of impending hazards in space, and so it will also directly benefit. Finally, the DOE builds satellite instrumentation that is hosted on satellites owned and/or operated by the DOD and Intelligence Community. The owners/operators of these satellites rely on predictions from AFWA/SWPC, and hence will also benefit from such a capability.

Progress

During FY14, we successfully utilized an approach to specify the global distribution of chorus waves using precipitation of low-energy electrons as measured by the NOAA POES constellation as a proxy, which is calibrated against measurements of the waves made by the Van Allen Probes. We also successfully utilized the low-energy source population measured by the Van Allen Probes as a boundary condition in our DREAM3D diffusion code. The combination of measured low-energy source population and global wave specification allowed us to model a complex geomagnetic storm

that occurred during October 2012, early in the Van Allen Probes mission. Our code successfully modeled many aspects of the storm, including the location of the peak in phase space density (PSD), the size of the PSD peak, and the timing of the acceleration. This work was presented at the 2013 Fall AGU as one of 4 selected presentations in a highly competitive session that received more than 60 submissions. The work was published in two articles that appeared in a special issue of Geophysical Research Letters on early important results from the Van Allen Probes mission, was the subject of a NASA feature story on the agency's website, and also appeared in the April 2, 2014, issue of LANL's Science Highlights.

Future Work

We will build event-specific wave models for the entire duration of the Van Allen Probes mission rather than using a statistical model.

We will run the DREAM3D code for all HSS events during the life of the Van Allen Probes mission.

Incorporate event-specific plasma density measurements made by the Van Allen Probes into the calculation of diffusion coefficients, and use an uncertainty model for the plasma density to quantify uncertainties on diffusion coefficients.

Predict event-specific energization of MeV electrons, and compute prediction efficiencies by comparing to data. We will not be able to modify DREAM3D to permicomplex (non-dipole) magnetic field configurations during Year 2, as originally scheduled, due to the 8% budget cut.

Conclusion

We expect to prove, or disprove, the hypothesis that it is the variability of the low-energy electron source population which, when combined with geomagnetic event-specific wave distributions, is responsible for the variability of post-event high-energy electron fluxes. If proven true, this hypothesis will lay the foundation for predicting post-event high-energy electron fluxes hours to days in advance, an important capability for protecting space-based assets. If proven false, intermediate objectives like producing an event-specific empirical wave database will be of value to the scientific community.

Publications

Chen, Y., G. Reeves, R. Friedel, and G. S. Cunningham. Global time-dependent chorus maps from low-Earth-orbit electron precipitation and Van Allen Probes data. 2014. Geophysical Research Letters. 41 (5): 755.

Ripoll, J. F., J. M. Albert, and G. S. Cunningham. Electron lifetimes from narrowband wave-particle interactions

within the plasmasphere. To appear in Journal of Geophysical Research-Space Physics.

Tu, W., G. S. Cunningham, Y. Chen, M. G. Henderson, E. Camporeale, and G. D. Reeves. Modeling radiation belt electron dynamics during GEM challenge intervals with the DREAM3D diffusion model. 2013. Journal of Geophysical Research-Space Physics. 118 (10): 6197.

Tu, W., G. S. Cunningham, Y. Chen, S. K. Morley, G. D. Reeves, J. B. Blake, D. N. Baker, and H. Spence. Event-specific chorus wave and electron seed population models in DREAM3D using the Van Allen Probes. 2014. Geophysical Research Letters. 41 (5): 1359.

Multidisciplinary Studies of Long Non-coding RNAs: towards a Structural Basis for RNA in Epigenetics

Karissa Y. Sanbonmatsu
20130319ER

Introduction

RNA (ribonucleic acid) is DNA's molecular cousin. RNA is similar to DNA in composition; however it often performs a function in the cell, unlike DNA, which is considered solely an information carrier. In all living systems, including humans and bacteria, the information for the blue print of the organism resides in DNA. The blue print is implemented by transferring the genetic information from DNA to RNA. Next, the genetic information is converted from the RNA into proteins, which make up the structures of the cells and perform the biochemistry.

RNA has long been thought to mainly serve as a transferring medium, moving information from DNA to proteins. However, in the past five years, it has been found that the vast majority of the human genome (more than 90%) is converted into RNA, but never gets converted into proteins.

In the past two years, it has been found that much of this RNA is in the form of long non-coding RNA (lncRNA, or 'link' RNA). These gigantic RNAs do not 'code' for protein, but instead are thought have a function themselves: turning on and off other genes. The RNAs are often associated with epigenetics. Epigenetics has exploded in the past five years and is closely related to stem cell programming. In epigenetics, Larmarkian-like effects occur, where the environment modifies, but does not mutate DNA. These modifications are passed down to future generations of organisms. For example, babies undergoing extreme stress shortly after birth have an altered stress response, which is passed down to the grandchildren.

While many long RNAs have been found to be critical for cancer, hereditary disease, brain function and development, the mechanism of long RNA action is not understood. We will perform the first ever structural study of long RNAs to help determine their mechanism.

Benefit to National Security Missions

We will produce preliminary data for specific NIH calls in cancer-related non-coding RNAs and several calls for NIH's epigenomics program for epigenetic mark discover, including the role of noncoding RNAs in regulation of transcription (Jerome Garcia). The project is directly related to DARPA's CLIO Memory thrust, including "basic research towards use of epigenetic systems to report environmental events" (Cathy Cleland). It is indirectly related to DOE BER Biological Systems Science "Low dose radiobiology effects on epigenetic regulation".

Progress

In the past fiscal year, we applied our structure technique (shotgun secondary structure) to several more long non-coding RNA systems. The first system is COOLAIR, a canonical epigenetic switch in plants that allows plants to flower only after prolonged exposure to cold. The second system is Braveheart, a long non-coding RNA that plays a key role in heart cell development. The third system is Gas5, which is critical for hormone signaling. To accomplish this, we transcribed the RNA for each system, denatured the RNA, folded the RNA and chemically probed the RNA. In chemical probing, a special reagent is added that only reacts with highly mobile nucleotides, allowing us to map which nucleotides are base paired in double helices and which nucleotides are single stranded. In this way, we determined candidate secondary structures of the long non-coding RNAs.

Future Work

In this fiscal year, we will finalize secondary structures of (1) COOLAIR, a canonical epigenetic switch in plants that allows plants to flower only after prolonged exposure to cold, (2) Braveheart, a long non-coding RNA that plays a key role in heart cell development, and (3) Gas5, which is critical for hormone signaling. To accomplish this, we will perform computational studies to eliminate possible

secondary structure folds and produce the best RNA fold. We will take steps to validate these folds in vivo. We will start on a new system called HULC which is a long non-coding RNA thought to interact with microRNAs. We will also prepare complexes for preliminary 3-D studies.

Conclusion

Our goal is to perform the first structural study of long non-coding RNAs (ribonucleic acids). The only example of a large RNA complex whose 3-D structure has been solved is the ribosome, which took 3 decades of work. We will take the first step in structural studies of long non-coding RNAs by determining the 2-D structure. For large systems, 2-D structures are impossible to accurately determine computationally due to the large number of permutations and possible structures. We have devised a novel experimental technique called SHOT-GUN structure determination. We will use this to obtain the 2-D structure experimentally.

Publications

Computational & Experimental Studies: Ribosomes, Riboswitches & Long non-coding RNAs. Invited presentation at Fourth Annual Summer Symposium on Cellular Dynamics of Macromolecular Complexes. (Montreal, May 2014).

Structural Studies of Intact lncRNAs in Plants and Mammals. Invited presentation at Long non-coding RNAs: Marching towards Mechanism Keystone meeting. (Santa Fe, March 2014).

Hayes, R. L., J. K. Noel, P. C. Whitford, Mohanty, K. Y. Sanbonmatsu, and J. N. Onuchic. Reduced Model Captures Mg²⁺-RNA Interaction Free Energy of Riboswitches. 2014. *BIOPHYSICAL JOURNAL*. 106 (7): 1508.

Hennelly, S. P., I. V. Novikova, and K. Y. Sanbonmatsu. The expression platform and the aptamer: cooperativity between Mg²⁺ and ligand in the SAM-I riboswitch. 2013. *NUCLEIC ACIDS RESEARCH*. 41 (3): 1922.

Novikova, I. V., A. Dharap, S. P. Hennelly, and K. Y. Sanbonmatsu. Shotgun secondary structure determination of long non-coding RNAs. 2013. *Methods*. 63 (170): 1.

Novikova, I. V., S. P. Hennelly, C. S. Tung, and K. Y. Sanbonmatsu. Rise of the RNA machines: Exploring the structure of long non-coding RNAs. 2013. *Journal of Molecular Biology*. 425 (19): 3731.

Novikova, I. V., S. P. Hennelly, and K. Y. Sanbonmatsu. Do lncRNAs have secondary and tertiary structure?. 2012. *RNA BIOLOGY*. 9 (12): 1398.

Novikova, I. V., S. P. Hennelly, and K. Y. Sanbonmatsu. Structural architecture of the human long non-coding RNA,

steroid receptor RNA activator. 2012. *NUCLEIC ACIDS RESEARCH*. 40 (11): 5034.

Novikova, I. V., S. P. Hennelly, and K. Y. Sanbonmatsu. Sizing up long non-coding RNAs: Do lncRNAs have secondary and tertiary structure?. 2012. *Bioarchitecture*. 2 (6): 189.

Novikova, I. V., S. P. Hennelly, and K. Y. Sanbonmatsu. Experimentally determined secondary structures of cancer-related long non-coding RNAs. Invited presentation at 245th ACS National Meeting & Exposition. (New Orleans, 7-11 April, 2013).

Novikova, I. V., S. P. Hennelly, and K. Y. Sanbonmatsu. Tackling Structures of Long Noncoding RNAs. 2013. *INTERNATIONAL JOURNAL OF MOLECULAR SCIENCES*. 14 (12): 23672.

Sanbonmatsu, K. Y.. Rise of the RNA Machines: Long Non-Coding RNAs. Invited presentation at 10th Horizons in Molecular Biology Conference International. (Max Planck Institute, Gottingen, Germany, 9-12 Sept. 2013).

Sanbonmatsu, K. Y.. Integrating simulations and experiments of the SAM-I riboswitch. Invited presentation at RNA Dynamics. (Telluride, CO, 22-26, July 2013).

Sanbonmatsu, K. Y.. Large-scale simulations of biomolecular machines. Invited presentation at Biosupercomputing. (Tokyo, Japan, Dec. 2012).

Sanbonmatsu, K. Y.. Understanding the atomistic mechanism of magnesium effects of RNA dynamics. Invited presentation at Mini-symposium on Modeling, Simulation and Function of Biomolecular Assemblies.. (University of Tokyo, Tokyo, Japan, Nov. 2012).

Sanbonmatsu, K. Y.. Dynamics of riboswitches: Molecular simulations. To appear in *Biochimica et Biophysica Acta (BBA)-Gene Regulatory Mechanisms*.

How Trees Die: Multi-scale Studies of Carbon Starvation and Hydraulic Failure During Drought

Sanna A. Sevanto
20130442ER

Introduction

In this project we will develop Ultra Low Field (ULF) Nuclear Magnetic Resonance (NMR) and Magnetic Resonance Imaging (MRI) to simultaneously detect changes in both water and carbon use of trees and use this novel technique in targeted drought stress experiments for building a comprehensive multi-scale view of the role of carbon and water in plant mortality. NMR and MRI are ubiquitous tools for non-invasive studies of soft-tissue anatomy and function in medicine and biology and their suitability to studying water dynamics inside plants has been demonstrated. The traditional techniques, however are difficult to use in studies of trees because they require permanent magnets of high magnetic field that limit detectable sample size and shape restricting in vivo applications. The major challenge of studies of tree physiology and mortality is a lack of non-invasive methods to detect water and carbon dynamics. These substances travel through the plant along pressure gradients and any invasive method will immediately change the state of the system when applied. Therefore, development of non-invasive methods capable of in vivo measurements of plant function is essential for advancing our understanding of plant function and responses to climate. ULF NMR/MRI uses simple pulsed electromagnets and optimized detection coils that operate in room temperature using very low magnetic fields; three orders of magnitude lower than traditional NMR/MRI making this technique adaptable to natural plant environment. The ULF NMR/MRI system is also very light (~10lb) and coil size is adaptable to tree size enabling measurements at several locations on a tree simultaneously.

Benefit to National Security Missions

Understanding global climate change impacts and feedbacks with terrestrial ecosystems is a critical mission for DOE-SC-BER. Climate change and weather will affect

national security impacting also trade and transportation as well as communication. Mechanistic understanding of vegetation function during drought and mortality is critical fundamental knowledge for prediction of progress of global climate change via the interactions of vegetation with climate. Forests store ~30% of fossil fuel emissions, and forest mortality may release large amounts of carbon dioxide to the atmosphere affecting predictions of atmospheric carbon storage and effects of fossil fuel use. Forest mortality and increasing drought will also impact restoration of natural environments. Currently, understanding the mechanisms of vegetation mortality relies on unproven hypotheses because we lack non-invasive, in vivo methods to study plant water and carbon dynamics. The interaction of water and carbon transport in plants is one of the fundamental unresolved topics of plant biology. Improving our understanding of carbon-water interactions inside plants is critical for understanding controls of productivity (photosynthesis) and material allocation as well as plant water use. In addition to trees, the methods developed in this project will be applicable to other type of plants from crops to biofuel crops, and the fundamental science results can be applied to improve renewable food and energy resources.

Progress

In the past 12 months we have completed system development for detection of water content changes in plants. This includes the design and implementation of next generation optimized field generation and pulse sequence generation. We have conducted measurements on living trees under drought in greenhouse conditions as well as calibration measurements in controlled temperature chambers for tackling the temperature sensitivity of the system. Based on these experiments we have developed a thorough understanding on how varying temperature affects our NMR signal and developed a model for correcting for

temperature variation. This work placed us to the point where we can start using the NMR system for real plant studies. We have begun these experiments according to the plan by first using the NMR system for understanding progress of hydraulic failure. We have detected decreasing water content in trees under drought in greenhouse conditions. To verify bubble formation in the tree trunks that would lead to hydraulic failure during drought, and to understand how bubble formation shows in our NMR signal we have conducted studies on aspen branches where we induced bubble formation using a surfactant, and verified existence of bubbles with x-ray tomography.

We have prepared and submitted a manuscript on the NMR system to *Reviews of Scientific Instruments* and are preparing another manuscript on the temperature correction model and its implications on signal interpretation in plant studies to be submitted to a plant journal such as *Plant, Cell and Environment*.

Future Work

The goal of the next fiscal year is to use the Ultra Low Field (ULF) Nuclear Magnetic Resonance (NMR) in for studying tree drought mortality and the role of water and carbon dynamics in tree mortality in a greenhouse environment. We will also continue developing Magnetic Resonance Imaging (MRI) of water content changes and NMR detection of carbohydrates. In the experiments we will use manipulative methods such as surfactants and tree girdling to promote hydraulic failure and carbon starvation to determine the link between hydraulic failure and carbohydrate availability. We will use ULF-NMR for detection of changes in water dynamics together with well-established plant physiological methods (gas exchange, sap flow, tissue water content).

Conclusion

Our technical goal is to develop Ultra Low Field (ULF) Nuclear Magnetic Resonance (NMR) and Magnetic Resonance Imaging (MRI) to accurately quantify water and carbon dynamics inside a tree in natural environments. Our science goal is to use ULF NMR/MRI to determine the roles and interactions of water and carbon cycling in tree drought mortality. Currently plant physiology and mortality studies lack non-invasive, in vivo methods. Our new technique will provide the key parameters and insights for mechanistic modeling of plant mortality, which is critical for understanding climate impacts and feedbacks on vegetation.

Publications

Cruz, N., J. Yoder, and M. Espy. Active Q-switching in NMR

applications. Presented at 13th Annual Student Symposium, Los Alamos National Laboratory . (Los Alamos, NM, July 26-27).

Cruz, N., M. W. Malone, D. J. Hart, S. Sevanto, and M. A. Espy. Tracking water flow in trees using NMR. Presented at 14th Annual Student Symposium. (Los Alamos, NM, 5 Aug, 2014).

Hart, D. J., M. W. Malone, S. Sevanto, M. A. Espy, and N. Cruz. Measuring the water content in trees using NMR. Presented at 14th Annual Student Symposium. (Los Alamos, NM, 5 Aug, 2014).

Malone, M. W., J. Yoder, M. A. Espy, and S. Sevanto. In vivo observation of drought response in a tree with low-field NMR. *Plant, Cell and Environment*.

Malone, M. W., J. Yoder, M. A. Espy, and S. Sevanto. Disentangling biology and physics to measure water in trees. Presented at *Plant Biology*. (Portland, OR, 12-16 Jul. 2014).

Malone, M. W., J. Yoder, M. A. Espy, and S. Sevanto. Disentangling biology and physics to measure water in trees. Presented at NMR². (Albuquerque, NM, 3 May, 2014).

Malone, M. W., J. Yoder, M. A. Espy, and S. Sevanto. Disentangling biology and physics to measure water in trees. Presented at LANL Postdoc Research Day. (Los Alamos, NM, 11 Jun, 2014).

Sevanto, S.. Phloem transport and drought. 2013. In 3rd International Conference on Plant Vascular Biology. (Helsinki, Finland, 26-30 Aug, 2013). , p. 56. Helsinki: Helsinki University Press.

Sevanto, S.. Phloem transport and drought. 2014. *Journal of Experimental Botany*. : doi: 10.1093/jxb/ert467.

Yoder, J.. Measuring absolute water content of trees in vivo with low field NMR. Invited presentation at Physics Division Summer Seminar PostDoc Series. (Los Alamos, NM, June 26, 2013).

Yoder, J., M. A. Espy, M. W. Malone, and S. Sevanto. Low-field NMR for the in vivo study of water content in trees. To appear in *Review of Scientific Instruments*.

Yoder, J., M. Espy, N. McDowell, J. Resnick, and S. Sevanto. Measuring absolute water content of trees in vivo by low field NMR in an uncontrolled environment. Presented at 54th Experimental Nuclear Magnetic Resonance Conference. (Pacific Grove, CA, 14-19 April, 2013).

Pyrocumulus Collapse: Unpredicted Wildfire Dangers

Rodman R. Linn
20130487ER

Introduction

The Las Conchas wildfire surprised everyone when it unexpectedly burned over 35,000 acres in less than 7 hours during its first night even though it was burning downhill in sparse vegetation and under mild wind conditions. One theory for this peculiar behavior is that a particulate-laden portion of the fire-induced pyrocumulus (pyro-cu) column collapsed, and unleashed a symbiotic density current/fire front that incinerated everything in its path. However the precipitating phenomenology of these events is not understood. LANL's coupled fire/atmosphere model, FIRETEC, will be used in three tandem efforts and will focus on fundamental process. These initial foci are: 1) assuring that the coupled fire/atmosphere code, HIGRAD/FIRETEC adequately captures the interaction between winds and plumes, 2) deciphering potential causes strong down drafts of down slope density current, and 3) understanding the interactions between a density current and a fire front. The final goal is to better understand key aspects of the coupled fire/atmosphere interaction that occurred in the first night of the Las Conchas fire and identify what combined fire/atmosphere dynamics could have lead to the unexpected observed fire behavior. Such an effort has never before been possible due to computational cost and complexity of process interactions, but LANL's R&D 100 award-winning HIGRAD/FIRETEC is being reformulated to take advantage of LANL's new High Performance Computing (HPC) machines.

Benefit to National Security Missions

This work will establish the capability to perform much larger coupled wildfire simulations and enable wildfire risk assessment across the DOE complex. This work increases LANL's unique capacity to study coupled fire/atmosphere phenomena in realistically complex environments and supports the USDA Forest Service (USDA FS) wildfire research and management

missions. This work will position LANL to serve a larger research role and to assume direct relevance to the fire management sector of the USDA FS. Pyro-cumulus columns inject significant amounts of particulate high in the atmosphere and thus have significant impacts on the atmosphere's radiation balance.

Understanding pyro-cumulus dynamics, conditions leading to collapse, and the effects of resulting density currents on fire behavior is crucial for elucidating the fire-related effects from an urban nuclear event (on US soil or elsewhere). In this setting, density currents would be channeled by street canyons, thereby focusing the kinetic and thermal energy and potentially increasing damage by an order of magnitude. LANL has ongoing activities in support of DHS, STRATCOM, and DTRA to understand damage and lives at risk from an urban conflagration that could likely result in a pyro-cumulus collapse.

Progress

Non-dimensional large-scale plume characterization: A novel non-dimensional analysis of the well-known non-buoyant jet-in-a-crossflow (JICF) was completed and is being extended to large-scale wildland fire plumes with an eye on producing useful characterization metrics applicable to managers in the field.

Non-dimensionalization of the governing equations for the JICF yields a velocity ratio, and Reynolds number dependence for many of the plume characteristics associated with the resultant plume height, fluxes, and mixing characteristics..

Non-dimensionalization of the Navier Stokes equations via the buoyancy term reveals the convective Froude number and Reynolds number emerging as the key independent parameters. The convective Froude number in equations for a heated plume the atmosphere

is analogous to the vertical vs ambient velocity ratio in the simple NB-JICF case, suggesting a similar non-dimensional characterization of plume height, mixing, and fluxes can be pursued.

Density-current fire interaction: Progress has been made in the initial exploration of the interaction between a density current and wildfires. This preliminary analysis is the first exploration into this topic that includes the two-way coupled fire behavior and it leverages previous HIGRAD efforts focused on dust storms on Mars and density-current magnitude estimates from above-mentioned plume dynamics explorations.

Initial results show that the cross-stream vorticity and reverse velocity gradient near the head of the density intensity the fire spread and intensity. These results highlight the importance of three-dimensional interactions between fire and winds

This analysis, which included surface grass fires and canopy fires in Ponderosa pine, suggests that the vegetation structure has significant impacts on the coupling between the density current and the fire intensification due to its impacts on the near-surface.

Mountain wave-fire interaction: Another topic that has emerged as a key focal point of this project is the effect of mountain waves on wild fire and any major related phenomena such as pyrocumulus. The area where Las Conchas Fire occurred is surrounded by highly mountainous topography and is subject to the influence of strong change in flow conditions due to mountains. When the atmosphere is stably stratified and the ambient environmental conditions are such that strong nonlinear mountain waves develop and break, the downstream of major mountains can suffer from gusty or turbulent winds due to downslope windstorm phenomenon and rotors, respectively. If collocated, wild fire can evolve very differently from the case without the mountain influence. The fire can spread much faster due to the mountain-induced gusty winds along the downstream direction or in opposite (upstream) direction due to turbulence-induced rotors, which will be a serious threat to fire fighters. The HIGRAD model has been used to simulate mountain waves properly in order to investigate the combined effect of mountain waves and fire. Preliminary results strongly suggest that the mountain wave is sensitive to the direction of winds impinging on the mountains and strongly change the characteristics of simulated fire. Further simulations are under way in order to systematically investigate this initial finding, also in context of pyrocumulus columns.

Theoretical and Numerical Multi-phase Model Development: The development of an expression for virtual potential temperature for an air parcel carrying soot was completed. This equation uses soot loading in the same way that water vapor is used in the common definition of virtual potential temperature. This soot model was then implemented in HIGRAD, along with an additional conservation equation for soot mass fraction. In order to derive this equation, soot was represented by C60, commonly referred to as fullerene or Bucky balls. It is assumed that the soot molecules in a control volume have a large enough mean free path that they do not interact with one another. As long as the soot concentration, q_s , < 0.1 , then the soot can be treated as part of an ideal gas mixture in the virtual potential temperature equation. The derivation uses Dalton's law of partial pressures to represent the different species in the mixture.

Future Work

The research will proceed with two foci: 1) understanding the coupled fire/plume/atmosphere/topography interactions leading to pyro-cu down drafts; and 2) the interaction of the resulting density current with wildfire behavior.

To capture the coupled fire/atmosphere behavior at high resolution (2–20 m), represent realistic length-scales (100s of meters to km), and avoid adverse impacts of numerical boundaries, one of the initial tasks will be to reformulate the Monte Carlo radiation and parallel input/output data exchange so that fully coupled fire/atmosphere simulations can be performed on the large domains required for this study.

The interaction between atmospheric mountain waves and fire behavior is becoming a primary focus of this work as it appears that there were mountain waves occurring during the first evening of the Las Conchas fire. The interaction between mountain waves and wildfires will be done through simulations using both idealized and realistic wind patterns.

The effects of a range of soot concentrations will continue to be evaluated in order to determine their implications and importance. In the event that plume dynamics are highly sensitive to soot concentration, this important finding would dictate a critical need for new instrumentation to accurately assess this hazard.

Initial wildfire acceleration and intensification as the leading edge of the density current reaches and passes through the fire will be studied over flat, sloping, and

canyon topographies. These simulations will highlight the importance of: 1) the pressure gradient across the leading edge of the density current; 2) the uplifting vertical velocities ahead of the current; and 3) the sustained accelerated winds within the current.

Conclusion

Fire behavior experts have suggested one viable hypothesis for the fire behavior during the first night of the Las Conchas fire: strong down drafts associated with the soot-laden pyrocumulus column (pyro-cu) that towered above the fire, causing a sustained density current carrying fire at high rates of speed. The proposed research will test this hypothesis, and decipher the combination of environmental conditions and fire behavior dynamics that enabled such an event. The insight provided by this research will help fire managers to identify pyro-cu collapse risk scenarios and to implement possible life-saving emergency actions if one occurs.

Publications

Canfield, J.. Wildfire dynamics: Understanding some behavior trends. 2014. PhD Dissertation, Florida State University / LANL LA-UR-14-22933. 28 Apr. 2014.

Kim, Y. J., R. Linn, J. Sauer, J. Canfield, and K. Costigan. Enhanced Risk of Wildfire Resulting from the Interactions between Pyro-Cumulus and Mountain Waves: Implications for Fire Research and Management. To appear in American Geophysical Union Fall Meeting. (San Francisco, 15-19 Dec. 2014).

Linn, R., J. Winterkamp, J. Canfield, J. Sauer, J. L. Dupuy, M. Finney, C. Hoffman, R. Parsons, P. Fancois, C. Sieg, and J. Forthofer. An Emerging Role for Numerical Modelling in Wildfire Behavior Research: Explorations, Explanations, and Hypothesis Development. To appear in American Geophysical Union Fall Meeting. (San Francisco, 15-19 Dec. 2014).

Sauer, J.. Towards improved capability and confidence in coupled atmospheric and wildland fire modeling. 2013. PhD Dissertation, Florida State University, 12 Nov. 2013.

Biocatalysts for Remediation of Uranium Wastes

Francisca Rein Rocha
20130590ER

Introduction

A strategic priority of the U.S. Department of Energy is the cleanup of a multitude of sites across the Nation that contain subsurface contamination with radionuclides from legacy waste accumulated over five decades of nuclear activities during the Cold War. Given the daunting volume scales of soil and groundwater contamination with uranium and toxic heavy metals at low concentrations, in-situ bioremediation by microorganisms has been greatly regarded as a promising approach to cost-effective, viable technologies for environmental decontamination. This biological approach is based on the established fact that some bacteria contain specific multi-heme, c-type cytochromes that can catalyze the reduction of uranium from its soluble form in oxidation state U(VI) to its insoluble U(IV) state as uraninite (UO₂). However, this reaction takes weeks to reach equilibrium and leads to incomplete reductions of uranium(VI) in contaminated sediments. Moreover, the use of sacrificial electron donors in bioremediation is impractical and promotes deactivation due to the competing re-oxidation by the reversible activity of sacrificial agents.

A major bottleneck for further advances in the derivation of effective technologies to address this grand challenge is the missing knowledge about the reaction mechanisms and their specific metal-binding interactions. Therefore, the overarching goal of our proposed research is the development of improved, bioengineered enzymes as biocatalysts toward the efficient and selective bioremediation of nuclear waste.

We will achieve this high-impact objective through an interdisciplinary application of our combined capabilities in biological and physicochemical sciences. Our research efforts were designed to address a critical environmental/health challenge of immediate national concern as well as to create new capabilities of relevance to current and emerging Laboratory missions

in this direction.

Benefit to National Security Missions

This research supports the above missions by providing advancements toward the environmental decontamination and cleanup of nuclear waste. A key component of this research that underpins core missions in national security and stewardship is the development of new capabilities and knowledge about the physicochemical behavior of actinides/radionuclides. This project also ties directly into the LANL/LDRD Grand Challenge “Complex Biological Systems” (specifically “to resolve national challenges in energy, health and environment” as well as “biological interactions and metabolic patterns that control ecosystem functions”). The importance and urgent needs for basic science to enable bioremediation technologies have been recognized and stimulated by several DOE initiatives, especially through the Office of Biological and Environmental Research. In addition to DOE, this research has high relevance to NNSA, DoD, and DHHS (NIH) programs. With underlying themes related to (bio)sensing/detection of radionuclides or toxic substances, nuclear forensics, molecular bioelectronics, and bioenergy, the outcomes of our proposed R&D may naturally lead to ties into programs within DHS, Intelligence Agencies, DoD (DARPA, DTRA, ONR), and DOE (BES, ARPA-E) among some of the identified agencies/programs.

Progress

One of the most important milestones reached in the first phase of the project was the successful implementation of the new preparative methods and bio-analytical techniques needed for the expression, isolation, purification, and structural characterization of our uranium-reducing biocatalyst. Producing the tetra-heme reductase *D. desulfuricans* cytochrome c3 (Cyt c3) at the target qualitative and quantitative levels was

a particularly significant accomplishment because multi-heme cytochromes are generally more difficult to express correctly, since co-factors are needed to enable the proteins to obtain their native fold. In Cyt c3, four hemes must be attached via thioether linkages to the polypeptide chain at the CXX(XX)CH binding sites, and the correct distal axial ligands must be connected to the metal center (trivalent iron) in the nascent protein. In our approaches involving *E. coli* recombinant expression, specific molecular assembly proteins were required for these critical interactions to form properly. Among the achieved improvements in the expression of Cyt c3, the pC3 plasmid carrying the Cyt c3 gene was co-expressed with the pEC86 plasmid carrying genes of helper maturation proteins. Other systematic changes have also led to further optimizations towards high yields, especially strategies involving auto-induction and temperature effects. We have found that auto-induction processes allow for control over amounts of media and supplements for bacteria growth to high densities prior to protein expression. Another key finding was that decreasing the typical growth temperatures, which causes bacteria to grow slower, presumably allowed the protein more time to properly fold into its native form. Following expression, the protocols for extraction, purification, and analysis of Cyt c3 have also been implemented and applied, from which the products have purified/analyzed by ion-exchange chromatographic column (Sephacrose), gel electrophoresis (SDS-PAGE), Coomassie/heme staining, absorption spectroscopy (UV-Vis and IR), and electrochemistry (cyclic and pulse voltammetries).

As our target application requires surface immobilization of the biocatalyst, we have also generated Cyt c3 tagged with histidines (His-tag Cyt c3) so that it can be tethered to functionalized electrodes for in-situ electrocatalytic reduction of uranium. To this end, a twelve-histidine residue was placed at the C-terminal of the protein, with a cleavage site (TEV protease) introduced between protein and His-tag to provide us with the flexibility of cleaving the tags and obtain the wild-type Cyt c3 from this same derivative. Following purification via Ni-NTA column, we have begun to structurally and functionally characterize this new His-tag Cyt c3 construct. Measurements by far-UV circular dichroism (CD) showed that this construct is well-folded and has retained its helical structure. Importantly, our spectroscopic and electrochemical characterizations in aqueous solutions as well as immobilized as electrode films clearly indicate that His-tagging had no negative impact on either the structural stability or the redox potentials of the heme sites (-0.55 to -0.60 V vs Ag/AgCl), consequently retaining the reductase activity of Cyt c3. Since medium effects can play an important role in the

treatment of uranium samples in complex environments, we are now applying our in-situ spectroelectrochemical techniques not only to probe structure/function-property relationships as a function of the multiple oxidation states of Cyt c3 but also as a function of pH, temperature, and ionic composition and strength. Furthermore, these methods combining interfacial bioelectrochemistry and UV-Vis-IR optical spectroscopies have begun to prove their powerfulness in developing an elucidation of reaction mechanisms for the complex catalytic U(VI)/U(IV) reduction by Cyt c3 and derivatives. Along with these synergistic tasks involving structure-function relationships and mechanistic redox characterizations, the ability to finely manipulate Cyt c3 by our underway site mutations will allow us both to understand and to rationally re-design our biocatalyst with improved efficiency and reactivity towards multielectron uranium-reductase activity.

Overall, our project efforts are on track. In addition to a successful first-year review, our progress to date has already resulted in at least two publications in preparation.

Future Work

With our capabilities established and methodologies successfully proven for both wild-type and His-tagged Cyt c3, we are currently working on our planned studies of Cyt c3 mutants by site-directed mutagenesis in order to understand the nature of biocatalyst-uranium binding and thus engineer optimizations for increased selectivity/affinity towards hexavalent uranium. The mobile uranyl dication (UO_2^{2+}) is a linear dioxo species that prefers to coordinate up to six donor ligands in the equatorial plane. Uranyl-protein motifs show that binding typically occurs through carboxyl groups such as in aspartate and glutamate. In addition, hydrogen bonds between uranyl and backbone amide groups are predicted to enhance the metal-protein interaction. Therefore, we plan to substitute the binding pocket of Cyt c3 (in the regions of lysine 14 and 56) with glutamate/aspartate residues to enhance specific binding and identify structural features that are essential to uranium reduction.

Also, with our interfacial chemistries validated for surface modifications and biocatalyst immobilization onto electrodes, we can now design and fabricate "biofilm reactors" for the detection and processing of uranium reduction. This is an ideal strategy for restoration of contaminated groundwater because it allows for the removal and recovery of precipitated contaminant from the subsurface by physical deposition of a stable precipitate on the electrode – a technically and economically viable approach that can be directly applied to remediation technologies.

Conclusion

By seeking the understanding and application of chemical principles underlying the multi-electron reductase activity of cytochromes c3, our research can lead to high-impact contributions to the permanent environmental bioremediation of radionuclides and toxic metals.

Through interdisciplinary application of biological and physicochemical capabilities, we strive toward advances of fundamental and practical importance for enabling the development of improved, bioengineered radionuclide-reducing systems to efficiently address the problem of incomplete reduction and recovery of uranium(VI) wastes. In addition to health/environment sciences and radionuclide (bio)chemistry, this project has a high potential for impact in areas such as nuclear forensics, (bio)sensing/detection, and bioenergy.

Publications

Rein, F. N., D. M. Vu, and R. C. Rocha. Multi-electron reductive bioelectrocatalysis by a cytochrome c3. *Catalysis Science & Technology*.

Rein, F. N., D. M. Vu, and R. C. Rocha. Direct electron transfer of tetraheme cytochromes at functionalized electrode interfaces. *Biosensors and Bioelectronics*.

Structure Determination of Large and Membrane-Bound Proteins by Nuclear Magnetic Resonance (NMR) Spectroscopy

Ryszard Michalczyk
20130620ER

Introduction

This project addresses our current lack of knowledge of structure and function of membrane proteins and large protein assemblies by developing and applying novel Nuclear Magnetic Resonance (NMR) and stable isotope labeling methods to determine their solution structures. The limited spectral resolution of traditional multi-dimensional NMR experiments, coupled to magnetization losses due to fast relaxation in large proteins, presently limits the size of biomolecules suitable for NMR spectroscopy to <50 kDa for high resolution structures. We will address these critical shortcomings by developing new solution NMR methods and isotope labeling schemes to produce the largest de novo NMR solution structures to date of a large, flexible protein complex (132 kDa) and a membrane-embedded system (74 kDa).

The innovative aspect of this research lies in the interactive use of specific, site-selective isotope labeling and optimization of NMR methods for this specific labeling scheme. We will improve existing and develop new NMR methods applicable to solution structure determination of large protein complexes and membrane proteins by selective stable isotope labeling. We will design selective isotope labeling patterns and synthesize selectively labeled amino acids and metabolic precursors for protein labeling in vitro and in vivo. These methods will be applied to obtain the NMR solution structures of a 132 kDa protein complex and a membrane-inserted permease of 74 kDa. These will be the largest structures ever determined by NMR and will place LANL at the forefront of modern structural biology.

The results will provide new, unique, and exciting information about large, complex systems involved in synthesis of bioactive compounds (antibiotics, anti-cancer drugs, virulence factors, toxins, etc.) and development of antibiotic resistance, leading to their manipulation and subsequent production of new

therapeutics and drugs. The potential impact of this research is vast.

Benefit to National Security Missions

Knowledge of the structures and mechanisms of both large proteins and their complexes and membrane-bound proteins is critical to our understanding of and intervention in processes as varied as antibiotic resistance and biosynthesis, biofuels production, and disease development (Parkinson's, Alzheimer's, diabetes, etc.). This project is directly related to LANL's missions in Global Security, Biothreat Reduction, and Energy Security, and success of this project will open the structural biology field to the detailed mechanistic studies of large protein complexes and membrane-bound proteins involved in the above as well as many other processes placing LANL at the forefront of the field. Leveraging the results obtained here with LANL's synthetic stable isotope capabilities, will open funding areas from NIH, DTRA and DOE. Program managers in Global Security (Kirsten McCabe) and DOE (BES/BER) will be informed of the results of our research so that future funding for these efforts can be developed.

Results obtained from this project will allow intervention into systems related to antibiotic resistance and toxin synthesis, leading to further research into development of new antimicrobials, inhibitors of efflux pumps and mechanism of membrane protein action relevant to multiple disease states. This relates directly to Biological Weapons and Defense and Pathogen Detection and Countermeasures. As such, this research is of potential high relevance to DOE, DOD and DHHS. It will also lead to discovery and innovation in Fundamental Chemistry (syntheses with stable isotopes) and Fundamental Bioscience.

Progress

During the past 12 months of the project, we continued development of new NMR (Nuclear Magnetic Resonance) pulse sequences, implementation of data

handling protocols and synthesis of further isotopically labeled amino acids.

For data acquisition and handling we have performed further tests of Non-Uniform Sampling (NUS) schemes based on Iterative Soft Threshold (IST) reconstruction algorithms to determine minimum number of data points in multidimensional experiments that allow for faithful reconstruction. The method will allow us to reduce experimental time 4-fold for 3-dimensional NMR experiments and 10-20-fold for 4-dimensional experiments. Final tests will be performed on selectively labeled large proteins once they are produced from labeled amino acids.

We have also made further significant progress towards selective amino acid labeling for large proteins. For optimal NMR performance, all amino acids will have amino nitrogens labeled with N-15 and α -carbons labeled with C-13 and deuterated. The carbonyl carbons will be unlabeled and the side chains will have C-13 labeled and protonated carbons alternating with unlabeled deuterated carbons. A common precursor to these amino acids is [2-13C, 15N, 2H]-glycine attached to a chiral auxiliary synthon (2,10-camphorsultam). We have synthesized further large quantities of 2-13C-bromoacetic acid and [2-13C, 15N]-glycine. Following protection of both nitrogen and carboxyl groups of glycine, it was deuterated to produce a common precursor for all amino acids. While some cleavage of protecting groups was observed during deuteration, the deprotected glycine was recovered from reaction for re-use.

We have synthesized additional amino acids with desired labeling patterns. In a previous review period we obtained glycine, alanine, aspartic acid and tyrosine. We added to this list glutamic acid, serine, threonine, proline, valine and leucine. Syntheses of remaining amino acids are in progress. The most complex task is the synthesis of tryptophan aromatic ring. To keep the synthetic part of the project on track to be finished by the end of 2014, we have decided to initially synthesize tryptophan with backbone labeling only and to revisit the ring synthesis at a later stage. This will have no impact on structure determination part of the project. Overall, chemical synthesis of amino acids is well on track.

For metabolic labeling of proteins, we have cloned the gene for the small protein, ubiquitin (76 amino acids) into E. coli hosts. Expression of this protein under various labeling conditions will allow us to monitor incorporation of isotopes at specific positions in amino acids, since NMR spectra for ubiquitin are well resolved and characterized. We have performed growth in the presence of labeled

glycerol and labeled pyruvate. Analysis of produced ubiquitin showed significant scrambling of all isotopes leading us to conclude that metabolic labeling using these precursors will not be acceptable for NMR of large proteins. We have also performed cell growth in minimal media supplemented with labeled glycine (which we synthesized). Analysis of isotope incorporation in the protein shows that for this approach to be successful we will need to judiciously incorporate inhibitors of amino acid synthesis into growth media to accomplish desired labeling. Further experiments are in progress.

To this end, expression of proteins of interest in cell-free systems has been investigated. We successfully synthesized catalytic (C) and activation (A) domains of enterobactin synthase using an E. coli based cell-free system. This system will be used for production of proteins for NMR studies using selectively labeled amino acids.

For the NMR methods development part of the project, we have modified and tested recently developed 3D TROSY-hNCAh and 3D TROSY-hN(CO)CAh NMR experiments by converting them to double-TROSY versions for further increased sensitivity in large proteins. We are actively working on modifications and optimization of the Time-Shared 3D-HSQC-NOESY experiment, which is being extended to a 4D pulse sequence with 13C phase shifts allowing for unambiguous identification of cross-peaks and determination of distance constraints.

Future Work

During the last year of the project we will perform the following tasks.

1. We will perform final optimization of recently developed 3D double-TROSY-hNCAh and Time-Shared 3D HSQC-NOESY NMR experiments for selectively labeled amino acids on samples of large proteins (>49kDa molecular weight) synthesized using in vitro expression system. To dramatically reduce acquisition time, we will incorporate non-uniform sampling (NUS) data reconstruction algorithms. Experimental time will be reduced by an order of magnitude, with improved sensitivity.
2. The Time-Shared 4D-HSQC-NOESY with 13C phase shifts allowing for unambiguous identification of cross-peaks and determination of distance constraints will also be optimized for labeled proteins. Here too we will use and optimize the NUS scheme in combination with coupled read-out and excitation TROSY for maximum sensitivity and resolution. This will increase spectral resolution, and will also simplify resonance assignments.

-
3. We will finish syntheses of all specifically labeled amino acids in the first two-three months of FY15 and progress to in vitro synthesis of labeled proteins. We will use Escherichia coli based cell-free system developed and tested in house to produce specifically labeled condensation, carrier and activation domains of the peptide synthetase complex and also produce samples of membrane inserted permease. We will combine the domains to form a soluble protein complex. These samples will be used for NMR structure determination.
 4. We will collect all necessary NMR data for structure determination of the synthetase protein complex using classical and our newly developed NMR experiments, obtain distance constraints and calculate the structure of this complex. We will also collect and process all NMR data for the permease and begin structure calculations for the permease as well.

Conclusion

We will improve existing and develop new NMR methods generally applicable to solution structure determination of large protein complexes and membrane proteins by selective stable isotope labeling. We will design selective isotope labeling patterns and synthesize selectively labeled amino acids and metabolic precursors for protein labeling in vitro and in vivo. These methods will be applied to obtain the solution structures of a 132 kDa protein complex and a membrane-inserted permease of 74 kDa. These will be the largest structures ever determined by NMR and will place LANL at the forefront of modern structural biology.

Redox Active Catalysts for C-C Coupling Reactions Relevant to Renewable Energy

John C. Gordon
20130672ER

Introduction

An effort to upgrade derivatives of glycerol (essentially a waste molecule produced on a huge scale as a result of biodiesel production) for the synthesis of fuels precursors and higher value chemicals, and to do it using well-defined, inexpensive catalysts based on earth abundant metals is a desirable goal. The research outlined herein targets the development of inexpensive catalysts, comprised of earth abundant metals, which are capable of such biomass derived molecule upgrading.

Precious metals are commonly used in catalysis due to their ability to promote two-electron processes, such as oxidative addition reactions. In contrast however, 1st-row metals tend to undergo one-electron redox changes or promote radical reactions, which has limited their more general use in catalytic chemistries. The proposed work will attempt to use redox active ligands capable of conferring multi-electron redox behavior on cheap and abundant metals, thus potentially applicable to upgrading glycerol based derivatives.

Benefit to National Security Missions

The proposed work will advance our understanding of the chemistry and chemical methods that directly bear upon energy security. Success in this area would seed the development of future approaches to more efficient chemistries, potentially providing a bridge from basic science to global scale energy solutions.

This project provides an opportunity for our team to collect results in this high profile area of renewable energy. Results from this exploratory work should prove invaluable in obtaining potential future funding from organizations such as DOE Office of Basic Energy Sciences (Catalysis Science) and DOE Office of Energy Efficiency and Renewable Energy.

Progress

The concomitant rise in global energy demands and growing concerns over climate change have spurred interest in the development of both alternative energy sources and less-expensive synthetic methods for high-value chemical feedstocks. In this regard, the development of novel methods for biomass conversion, specifically those designed for the coupling of three-carbon carbonyl molecules derived from glycerol into six (or higher)-carbon containing molecules represents a potential route for both fuel and fine-chemical synthesis from a readily-available and inexpensive precursor. Pinacol couplings are ideal reactions for the coupling of carbonyl-containing molecules. Typical reductants utilized for pinacol couplings include sodium, zinc, manganese, magnesium and aluminum metals, as well as transition metals such as vanadium and titanium, and lanthanides such as samarium and cerium. However, no efficient catalytic variant of pinacol coupling has been developed.

Our approach to the homocoupling of glycerol derivatives involves the use of iron centers supported by ligands that possess redox reactivity. The ability of redox active ligands to function as an electron 'sink' has been shown to facilitate multi-electron catalytic processes, and the use of iron catalysts with redox active ligands will participate in the two-electron reductive chemistry required for pinacol coupling.

Our first efforts towards pinacol couplings with redox-active metal complexes have centered on iron-containing catalysts. We have synthesized a new iron complex containing a redox-active ligand and begun reactivity studies establishing the ability of the reduced iron complexes to affect the homocoupling of ketonic substrates. Electrochemical experiments of this iron complex reveal two successive one-electron reductive

processes; comparison with the cyclic voltammetry data of the redox-active ligand suggests that the first reduction occurs on the iron center while the second reduction is largely ligand-based. Exposure of the iron complex to chemical reductants in the presence of an appropriate ligand results in the two-electron reduced iron species. Computational and spectroscopic studies aimed at elucidating the electronic structure of the iron complex are underway.

product of biodiesel (glycerol) into potentially useful fuel precursors and other chemical feedstocks.

Studies aimed at both stoichiometric and catalytic pinacol couplings with various substrates are in process as well. Exposure of the reduced redox-active iron complex to a slight excess of ketones such as benzophenone and acetone results in rapid formation of the anticipated pinacol products as confirmed by proton- and carbon-13 NMR spectroscopy. Encouraged by the pinacol coupling observed under stoichiometric conditions, we are currently screening catalytic conditions for pinacol coupling using both test substrates, such as benzophenone, acetophenone, and benzaldehyde, and biomass derived substrates, such as crotonaldehyde and acetone. We are also currently evaluating other iron complexes with different ligand scaffolds for this chemistry, as well as examining the mechanism by which the pinacol coupling occurs.

Future Work

We will continue to computationally screen existing ligands suitable for desired redox chemistries and attempt to make iron complexes supported by these. We will also design, prepare and synthesize other promising new redox active ligand systems. If successful in new ligand synthesis, we will synthesize and characterize new iron complexes derived from these scaffolds and test their redox chemistries with standard organic substrates that will serve as models for the biomass derived molecules. We will also move towards screening bio-derived substrates containing ketonic fragments for their ability to undergo desired chemistries.

Conclusion

Developing earth abundant metal-catalyzed processes to effect the low cost conversion of biomass derived feedstocks remains a challenge in the field of energy related chemistry. In part this is due to the inability of first row transition metals to participate in multi-electron redox processes. Success in this project would not only lead to a more fundamental mechanistic understanding of C-C coupling reactions with traditional organic substrates using these classes of metals, but also has the potential to convert species derived from a large scale waste by-

Novel Chemical Architectures for Supercapacitor Electrolytes: Comparing In Situ Scattering Measurements to Theory and Simulation

Cynthia F. Welch
20130681ER

Introduction

We aim to increase the energy storage density in supercapacitors, a family of devices well suited to the intermittent power generation associated with many renewable sources. We propose that tailoring the size and shape of the electrolyte in supercapacitors to match the electrode surface geometry will lead to enhanced energy densities, forming our central hypothesis. This hypothesis leads us to consider several nano-structured organic electrolytes (NOEs) as candidates for use in supercapacitors, as well as to study their behavior near and in the electrode pores. The novelty of our project lies in optimizing the electrolyte rather than the electrode. Many key questions about the behavior of the electrolytes in the harsh environments near electrodes must be answered for progress to be made. Our access to unique electrochemical sample cells that allow us to probe the in situ behavior of the electrolyte near electrode surfaces and our recent theoretical advances for the proposed electrolyte class provide the key enabling developments.

Thus, we have four major goals:

1. Produce multi-scale descriptions of the NOE materials in device settings
2. Discover the physical principles directing their spatial distribution in heterogeneous media
3. Explore their non-equilibrium route to this distribution upon charging/discharging the device
4. Encapsulate in quantitative expressions the physics dictating their performance

Benefit to National Security Missions

Many processes involved in manufacturing and transporting goods suffer from inefficiencies due to wasted energy. Similarly, many renewable energy sources (such as wind and solar) yield only intermittent electricity generation. We therefore require advanced devices that quickly capture and release stored

energy. If their energy densities can be improved, given that supercapacitors may deliver an order of magnitude more power than chemical batteries, they may dramatically improve the performance of dynamic energy capture and reuse systems. Our project aims to improve the energy densities of supercapacitors by tailoring the size and shape of the electrolyte to match the electrode surface geometry. Specifically, we will explore certain dendritic chemistries, which possess all of the key properties needed in a good electrolyte. In addition, several aspects of their physical chemistry recommend them for application in supercapacitors. These characteristics include precisely controlled size and shape, broad range of available sizes, high charge densities, low viscosities at relevant concentrations, and the ability to capture impurities.

Progress

Our goals for Year 2 of the project were as follows:

- Carry out Brownian dynamics (BD) simulations on the coarse grained models (CGM) within the Debye-Hückel and implicit solvent approximations. Examine the behavior of single and multiple molecules in the neighborhood of surfaces with different pore geometries. The surfaces will be modeled as static particles arranged in the desired topologies. Examine the behavior of blends of dendrimer electrolyte species in the presence of electric fields and model electrode surfaces. Apply an external electric field and track the phase separation of the two species.
- Using the information on the effective step length obtained in Year 1, construct a field theoretical model using the Edwards path integral formulation to predict the localization of the individual dendrimers onto various pore surface geometries. Extend this approach to multiple molecules, solving

for concentration within the pore. Compare the results with the CGM modeling (1 above).

- Construct molecular dynamics (MD) models of poly(amido amine) (PAMAM) dendrimers in aqueous solutions to compare to the CGM and experimental results. Continue quantum chemical stability studies of PAMAM in an electric field; use these results to introduce relevant fragmentation species into the MD simulations.
- Devise an extension of the Ginzburg-Landau theory for polymer blends to account for blends of the dendrimer electrolytes in solution and in the presence of an electric field.
- Experimentally challenge the simulations with reflectivity experiments on flat electrodes.

Over the past 12 months, we have made progress on each of the above goals, as detailed below:

We completed BD simulations of coarse-grained dendrimer electrolytes placed between two flat electrodes, using concentrations and electric field strengths relevant to typical supercapacitor applications. This work was published in ACS Macro Letters (Welch, P.M.; Welch, C.F.; Henson, N.J., "Flattening of Dendrimers from Solutions onto Charged Surfaces," ACS Macro Letters 2014, 3, 180-184) and featured on the cover of that journal in the February, 2014, issue. We are currently extending these simulations to other electrode geometries, such as porous electrodes.

The theoretical work used to extract an effective step length for dendrimers in Year 1 was published in J. Chemical Physics (Welch, P.M., "The Escape of a Charged Dendrimer from an Oppositely Charged Planar Surface", J. Chem. Phys., 2013, 139, 164906). This parameter was then used to compare the BD simulation results of (1) above to a scaling theory that describes the behavior of dendrimer electrolytes at flat electrode surfaces. Predictions from the theory agree well with the simulations. Combined, the simulations and scaling argument indicate that simultaneous adsorption and compression at the interface take place. We are currently extending this work to construct a field theoretical model using the Edwards path integral formulation to predict the localization of the individual dendrimers onto various pore surface geometries.

A post-doc was hired to spend a significant portion of her time in performing the atomistic MD simulations and quantum chemical stability studies. Though she has only been at LANL for about a month thus far, she has already

begun these studies. In addition to a LANL Institutional Computing allocation that we obtained in Year 1 for this project, she will take advantage of CPU time awarded to us from the Environmental Molecular Sciences Laboratory at PNNL. The computationally intensive nature of these studies will require that they be continued into FY15.

We have begun an extension of the Ginzburg-Landau theory for polymer blends to account for blends of dendrimers in the presence of an electric field. Due to the FY14 LDRD budget cuts, this task will continue into FY15.

A in situ electrochemical cell was constructed and we completed a set of neutron reflectivity experiments (on the SPEAR beamline at LANSCE) to probe the behavior of dendrimers at oppositely charged, flat electrode surfaces. Though analysis of the data is still underway, the results suggest that the dendrimers flatten in agreement with the simulation and theory results mentioned in (1) and (2) above. Due to a loss of beam during our scheduled time, we will continue these experiments in FY 15.

Future Work

- Using theoretical developments of FY14, map the information from the coarse-grained modeling (CGM) simulations to parameterize the resulting Ginzburg-Landau theory. Perform time-dependent Ginzburg-Landau (TDGL) simulations of the blend with simple surface boundaries and varying electric field strengths.
- Introduce multiple realistic (posts, polydisperse pores, etc) electrode geometries into the TDGL simulations. Calculate charge localization on the electrode surfaces as a function of imposed electric field strength. Explore similar CGM models at smaller scale.
- Explore the structure of the NOEs on realistic electrodes, comparing against the simulations, with small-angle neutron scattering.
- Measure capacitance of devices that combine dendrimer electrolytes with electrodes of various geometries (flat vs. porous, with different pore geometries).
- Continue atomistic MD and quantum chemical stability studies.

Conclusion

This project will produce: 1) A new set of theories for predicting when specific NOEs will partition within pores of various geometries; 2) A new theory for predicting how the environmental parameters dictate the structure of the multilayer arrangement of the NOEs near the electrode; 3) A new theory detailing the dependence of capacitance on the relationship between pore geometry and electrolyte

shape; 4) A multi-scale simulation model of a class of supercapacitor devices that may be used as the foundation for a future program at LANL; 5) New insight into the behavior of NOEs in complex environments.

Publications

Welch, P. M.. The escape of a charged dendrimer from an oppositely charged planar surface. 2013. *Journal of Chemical Physics*. 139: 164906.

Welch, P. M., C. F. Welch, and N. J. Henson. The flattening of dendrimers from solutions onto charged surfaces. 2014. *ACS Macro Letters*. 3: 180.

One-step Supercritical Fluid Extraction (SFE) and Separation of Rare Earths (RE)

Stephen L. Yarbrow
20140186ER

Introduction

We propose to engineer and demonstrate a prototype system that exploits the high solvent power of supercritical carbon dioxide coupled with extractants for lanthanide (rare earth) production. This approach will dramatically simplify lanthanide processing and separation. Essentially, in one-step, extract rare earth elements directly from ore with a supercritical CO₂ (SCCO₂)/extractant mixture (typically tri-butyl phosphate (TBP)) and adapt an aerodynamic isotope separation method to separate the heavier elements from the lighter elements while dissolved in the supercritical fluid. Current production methods require complex equipment and many steps such as dissolution, flotation, and filtration, and washing, separation requiring hundreds of separation stages, precipitation, and calcination. Supercritical fluids are powerful solvents. Coupled with the right extractants, the supercritical fluid can selectively remove the lanthanide from the ore, and then use an aerodynamic technique developed for isotope separation to separate the lanthanides while still in the homogeneous supercritical fluid. Aerodynamic methods demonstrated for uranium isotope enrichment are capable of effectively separating elements with weight differences of a few atomic mass units. After separation, reduce the pressure and recover the lanthanide solids thereby eliminating the majority of the current production steps along with the associated complexity, cost, and waste.

Benefit to National Security Missions

In 2012, Congress commissioned a study on the defense implications of China's control of the rare earth supply and the impact on US security. Congress is encouraging DOD to develop a long-term strategy to identify material weaknesses and vulnerabilities associated with lanthanides and to protect long-term U.S. national security interests. In addition, the Department of Energy (DOE) Energy Efficiency and Renewable Energy

(EERE) Advanced Manufacturing Office is providing \$120M to fund a Critical Materials Hub focusing on critical materials supply issues. A portion of their mission is to enable new sources of critical materials not now commercially viable, improve the economics of processing existing sources, and identify new uses for co-products and by-products that do not currently contribute to the economics of materials production. This mission integrates well with LANL's Materials for the Future Science Pillar's vision, "Pursuing the discovery science and engineering required to establish design principles, synthesis pathways, and manufacturing processes ...". We envision demonstrating the process on lanthanides to build a relationship with EERE and then extend the work to actinides to build programs related to NA-22/24 and defense programs material issues.

Progress

This is a new start and the accomplishments over the last 9 months will be summarized. The project will use supercritical carbon dioxide with selected co-solvents to selectively remove and separate lanthanides from oxides and simulated ores. Once in solution, different configuration of a centrifugal nozzle will be used to test the feasibility of separating the lanthanides dissolved in the dense gas phase with the co-solvents.

Accomplishments in FY 14 to date:

Extraction equipment

- Supercritical extraction unit has been procured and set up in the lab
- The IWD is complete and ready for use
- The lab area has been organized and is ready for use
- Pressure safety reviews have been completed and are ready for final approval
- Preliminary nozzle design has been completed and a nozzle fabricated (using a 3-D printer) to use to design modifications to the extraction equipment

Modeling and solubility studies

- Preliminary 1-D model of the centrifugal nozzle fluid dynamics has been developed
- Preliminary work evaluating thermodynamic models for predicting solubility has been completed
- Procedure for synthesizing model 'ore' formulations has been completed

Future Work

We will use commercially available "off-the-shelf" (COTS) equipment to measure solubilities except for the nozzle which will be fabricated in-house. In FY 14, we have procured and set up a SFT-110 unit from Supercritical Fluid Technologies and started solubility measurements. The solubility tests provide the concentration data that is an input to the simple nozzle separation model. We are collaborating with the LANL Center for Integrated Nanotechnologies (CINT) and their micro-fabrication capability to build simple nozzles for testing. The project has used their 3-D printing capability to fabricate a test nozzle for developing modifications to the SFT-110 unit. Essentially, there are two phases to the R&D plan: (1) Measure lanthanide solubilities from a well-characterized oxide substrate to develop the procedures and analytical support, then measure lanthanide solubility from simulated ore samples to get data on optimum operating conditions and extractants. (2) Use the solubility data to design and fabricate a simple nozzle device and with select SCCO₂ streams, measure separation factors and validate the CFD model.

In FY15, we plan on completing the solubility tests on oxides and simulated ore solid substrates initiated in FY 14 and use the data to validate a thermodynamic model with predictive capability. Separation testing with the nozzle will be initiated and completed. The separation factors for selected lanthanides will be measured and compared to the 1-D nozzle model developed in FY14. The combination of solubility data and thermodynamic model and nozzle data with a simple separation model will enable a economic and feasibility assessment to be completed for the technology.

Conclusion

The expected result is a demonstration of a high-efficiency dissolution and separation method for lanthanides, which has potential for extracting and refining actinides and other strategic metals. The product will be a demonstrated method and a conceptual engineering design of a plant for lanthanide recovery and purification.

Publications

Yarbro, S. L., R. M. Chamberlin, P. Martinez, L. Meyers, and Q. McCulloch. Two-dimensional model of curved flow with supercritical carbon dioxide in a diverging nozzle. 2014. Los Alamos National Laboratory unclassified release.

Deciphering the Algal Phycosphere

Armand E. Dichosa
20140216ER

Introduction

Identifying the exact bacterial symbiotes and their influence on algal biomass has yet to be accomplished. The most ideal approach to dissect this complex community is with GMDs and high-throughput flow cytometry. Upon completion of this study, we will have developed: (A) technologies to efficiently capture, co-cultivate target cells, and analyze direct cell-cell interactions; and (B) established a bioinformatic pipeline for genomics and transcriptomics analyses. Ultimately, this work can be broadly applied to other relevant studies, including host-pathogen interactions and co-evolution.

Our team will co-capture single algal and bacterial cells into one gel microdroplet (GMD) and wrap each GMD with growth media, thereby making microdroplets (MDs). MDs will be incubated under defined growth conditions. Using flow cytometry, each MD will be iteratively analyzed to determine which algae-bacterial pair demonstrates top-performing algal biomass. The consistently top-performing algae will be isolated and its associated bacterium identified using genomics. Transcriptomics will also be done to determine the interactions involved.

Benefit to National Security Missions

Our work is in direct support of the DOE mission of energy security through promoting science and technology that benefits renewable energy. As algae are widely accepted as a viable source for our country's energy needs, significant work is warranted to understand the basic biological processes that promote (and prevent) algal biomass production. Specifically, our work addresses this need to dissect and identify the associated bacteria that influence algal growth. Such fundamental understanding will greatly contribute to improving algal growth in a commercial production scale with greater efficiency (time, cost, and resources)

and lesser environmental impact (nitrogen or chemical input).

Our work also contributes to the mission relevance of scientific discovery and innovation through fundamental bioscience. It is widely accepted that ~99% of environmental bacteria (including human microbiome, soil communities, etc.) cannot be grown as pure cultures under laboratory settings. A basic premise is that we cannot achieve the exact growth conditions as the native environment in the lab and that specific bacteria are required to signal growth. By using gel microdroplets (GMDs) for co-cultivation with high-throughput flow cytometry, we can greatly improve our current understanding of bacterial growth and cell-to-cell interactions, and their significance to our nation's health, ecology, and economy.

Furthermore, our work develops a novel pipeline in both the wet-lab and bioinformatics fronts to specifically investigate cell-to-cell interactions. Thus, the DHS, NIH, and DHHS will benefit from our work as our novel technology development can potentially address host-pathogen interactions and co-evolution (e.g., endosymbiosis) investigations.

Progress

Capture of Target Cells

The capture of single cells in gel microdroplets (GMDs) is random, based on the current protocol and existing technology. This becomes a greater challenge when attempting to capture a controlled number of target cell species, which, for this study, is one algal cell with <5 bacterial cells in a single GMD. To this end, we have developed a modified protocol to reproducibly capture a single algal cell in GMDs. Using a similar strategy, we implemented a protocol to co-capture the algae-associated bacterial cells (<5 cells) per GMD with one algal cell.

Generated MDs Using Microfluidics

A key component of our proposed work is to sequester each GMD in microdroplets (MDs) comprised of nanoliters of defined growth media, whereby each GMD is a microculture independent from other MDs, but allows for thousands of simultaneous growth reactions and subsequent high-throughput screening with flow cytometry. To accomplish this goal, we tested several microfluidic designs and reagents and have (a) developed a droplet-generating microfluidics device to capture single GMDs in MDs, (b) identified the ideal preparation steps to generate stable MDs, such that each MD in the collection/incubation chamber does not coalesce with neighboring MDs during incubation for two weeks* (*which is more than sufficient as we seek to cultivate for 3 – 5 days), (c) determined that “cross-talk” between stable MDs does not occur, thereby assuring that each algal-bacterial interaction during growth within an MD remains separate, and (d) demonstrated viable, algal growth within MDs. Within this same scope, we have additionally investigated “deterministic encapsulation” of the GMDs inside MDs on the microfluidic platform, so that a higher fraction of MDs containing a single GMD can be achieved. To this end, we have developed multiple microfluidics platforms to perform the focusing/ordering of GMDs that can lead to deterministic encapsulation when conjugated with the microfluidic droplet generator (see a).

Developed Multiplexed Bacterial Phylotyping

To identify the specific bacteria associated with improved algal biomass, we have implemented method(s) to utilize next-generation sequencing at LANL to sequence the bacterial 16S rDNA (~300 bp) necessary for rapid phylotyping (i.e., taxonomic identification using a molecular marker; the current standard is the 16S rRNA gene) with a custom bioinformatics pipeline. This aspect of our research is in the validation stages.

Identified Relevant Bacteria

A complementary component of our work is to isolate and identify bacterial species that have a phenotypic influence on algal growth using conventional, ‘low throughput’ microbiology as a mitigation strategy. Our isolation of bacteria from an algal production pond has shown promising results when grown concurrently with algae *Chlorella*. Among our finds was the isolation of the bacterium *Williamsia* sp., which, when co-cultured with *Chlorella sorokiniana* enhanced the growth of the algae (compared to *Chlorella* grown without *Williamsia* sp.). Consequently, the genome of this isolate was sequenced and is currently being assembled for annotation and analysis to inform mechanisms of interaction. Conversely, a second isolate inhibited *Chlorella* growth when grown

in co-culture. This isolate is currently undergoing genome sequencing for eventual assembly and annotations.

Future Work

Collecting and Cataloging Bacterial Candidates

Our team already has shown bacterial isolates to either be beneficial (putative *Williamsia* sp.) or inhibitory (bacterial identification TBD) to algal growth (*Chlorella sorokiniana*), and these bacterial isolates are undergoing genome sequencing and annotations. At present and carrying on into FY15, we continue our efforts to sequester and perform genomics on additional candidate bacterial isolates of relevant significance to algal growth.

Conduct Co-culture Studies

Using bacteria native to an algal production pond system, we will isolate the ideal number of representative bacteria necessary to achieve co-capture of ~4 bacteria and one algal cell per GMD. Because we have already identified the relative quantities of each cell input to achieve this, our team is poised to transition to our developed microfluidics device to generate the MDs. We anticipate generating 105 – 106 MDs, which will be cultivated for ~2 [algal] growth cycles.

Characterizing Top-performing Bacteria

After cultivation in MDs, we will utilize flow cytometry to screen and isolate with high-throughput only the GMDs with improved algal biomass (expected ~1%) and the associated bacteria. These select GMDs will be sorted individually into 96-well culture plates for further cultivation. Each well indicating visible turbidity (i.e., bacterial growth) will be selected for further investigated for their direct affect(s) on algal growth in axenic algal cultures. Thus, the bacteria associated with algae displaying accelerated growth or improved lipid production by this method will be ideal candidates for subsequent genome sequencing (Aim 2D, FY16).

Conclusion

We will identify growth-promoting bacteria in an algal phycosphere (ecological area involving the bacteria and algal interactions) that provide essential nutrients for growth. Re-introduction of these same bacteria to production ponds should improve algal biomass yields, eliminate the additions of expensive vitamins, and reduce nitrogen inputs. Post genome sequencing, species-specific genetic markers will be identified for the tracking of growth-promoting bacteria in algae production system.

Intrinsically Disordered Proteins: New Tools for Old Controversies

James H. Werner
20140307ER

Introduction

Far from being static 3D structures, many proteins are substantially disordered and fluctuate dynamically between a large range of conformations. Many of these unstructured proteins fold into a more ordered conformation when binding a well-structured target. The exact manner in which this folding upon binding occurs, however, is still open to substantial debate. One reason for our lack of understanding of how intrinsically disordered proteins (IDPs) fold upon binding a target is due to a lack of experimental techniques capable of monitoring the conformation of a single IDP protein before, during, and after target binding. Here, we are proposing to develop a new method capable of monitoring individual intrinsically disordered proteins before, during, and after binding to a target. Moreover, we are applying this new, truly state of the art, method to study a problem of substantial scientific and programmatic interest: the method by which bacterial DNA is protected during sporulation. This project aims to study individual IDPs as they bind to and protect DNA in live bacteria. These studies should shed substantial light on the how IDP conformational dynamics influence their binding behavior in real, live cell environments and may lead to a better understanding of the molecular basis of how bacterial DNA is protected during sporulation. In addition, this work will substantially advance the state of the art in fluorescence microscopy by developing the first instrument capable of monitoring intra-molecular conformational dynamics while simultaneously following 3D intra-cellular transport dynamics.

Benefit to National Security Missions

Spores of *Bacillus* and *Clostridium* species have long been of interest due to their roles as agents of food-borne disease, food spoilage and bioterrorism (e.g. *Bacillus anthracis*). Small acid soluble proteins (SASPs) play a major role in long-term spore survival and bacterial persistence by protecting the spore DNA from

numerous physical and chemical damages. An enhanced understanding the molecular basis of spore DNA protection has the potential to lead to better eradication strategies. In particular, DTRA has an emerging interest in understanding and combating bacterial sporulation as reflected in a recent HDTRA1-12-CHEM-BIO-BAA call for multidisciplinary approaches to decontamination of *B. anthracis* spores. We further note that a successful demonstration of being able to simultaneously measure intra-molecular conformational dynamics and intra-cellular transport dynamics will position our team to respond aggressively and competitively for several NIH calls in single cell analysis (e.g. Single Cell Analysis Common Fund).

Progress

In the past year, we have made substantial progress to the goals of this research project.

On the instrument development side, we have expanded our 3D tracking microscope from 4 detectors to 8 detectors such that we can have 4 probe volumes for both a “red” and a “green” detection channels. These modifications have been completed for both the hardware and the software. We note the software modifications required a substantial amount of modifications to the existing 4 detector tracking system.

As of June of 2014, we are now ready to begin aligning the instrument and track objects that emit both red and green fluorescence emission, with our first tracking targets and alignment tools to be red and green quantum dots we have bound together by chemical means. Another potential tracking target is DNA labeled with two organic fluorophores (Alexa 488 and Alexa 594) at either end. We have synthesized this DNA sample and have characterized the energy transfer between the dye pairs by standard fluorimetry and by fluorescence lifetime measurements. This sample will be used to

optimize tracking parameters prior to work on intrinsically disordered proteins (which are more expensive and not suited to routine optical alignment).

As far as protein expression is concerned, we have been growing and optimizing the conditions for culture and harvesting the small acid soluble protein (SASP) from *Bacillus subtilis*. While our yields have been lower than more conventional, folded proteins, we anticipate soon having enough sample for standard ensemble characterization methods (infra-red spectroscopy and circular dichroism) of these proteins in the presence and absence of a DNA binding partner. We have also ordered the DNA plasmids needed to express double cysteine mutants of this SASP protein, which will follow the studies of the native (non-cysteine mutant) samples. These cysteine mutants will be fluorescently labeled with a fluorescent donor (Alexa 488) and acceptor (Alexa 596) dye pair for fluorescence resonant energy (FRET) studies of protein conformation and binding.

Future Work

- Fully align microscope for two color tracking
- Make the changes to the tracking microscope to observe two different colors while tracking
- Begin protein expression, labeling, and purification of the small acid soluble protein (SASP) SspC from *B. subtilis*
- Study binding of dye-labeled SspC to DNA by circular dichroism (permuting label locations as needed)
- Begin studying SASP conformation in solution by 3D Tracking smFRET

Conclusion

We will develop a method capable of simultaneous measurement of intra-molecular conformational dynamics with intra-cellular transport dynamics. This will be a broadly applicable tool for a large number of problems in cell biology, defining and expanding the state of the art in fluorescence microscopy. Moreover, we will use this new method to study the conformation of individual intrinsically disordered proteins before and after binding a DNA target both in solution and in live cells. These measurements will experimentally determine which of two classic models (induced-fit or conformational selection) better describes protein folding upon binding.

Electromagnetic Field Control of Cold Molecular Collisions

Brian K. Kendrick
20140309ER

Introduction

The goal of the proposed research is to develop, implement, and apply new theoretical and computational capabilities for including external electromagnetic field interactions in reactive scattering calculations of cold and ultra-cold molecular collisions. These new capabilities will be applied to several important molecular systems of experimental interest to demonstrate the potential for controlling the dynamics and most importantly the outcome of cold and ultra-cold molecular collisions including elastic, inelastic, and reactive channels. Recent rapid experimental progress in cooling, trapping, and colliding cold molecules has opened up this new and exciting, unexplored energy regime which is ripe for new discoveries and technological applications. Due to their unprecedented sensitivity, cold and ultra-cold molecular collisions are especially amenable to control by external electric and magnetic fields and recent experiments have begun to demonstrate this possibility. The control of molecular collisions has been a long sought goal with many important fundamental and technological applications including: synthesis of specific molecular species of interest, quantum computation, sensing, testing fundamental laws of physics, elucidating quantum enhanced reaction mechanisms (i.e., due to tunneling/resonances), investigating the role of non-adiabatic effects, and providing detailed information on molecular structure and intermolecular interaction potentials. The proposed research will develop and implement new capabilities into the already unique LANL quantum reactive scattering code to include external electromagnetic field interactions and to perform first-ever benchmark calculations on several important cold molecular collision systems including: $\text{LiNa} + \text{LiNa}$, $\text{Li} + \text{HF}$, $\text{Li} + \text{CaH}$, and $\text{OH} + \text{O}$. We expect to demonstrate remarkable control of the collision outcomes for each of these systems which will lead to new experimental studies and discoveries. These calculations will also lead to new fundamental insight into the mechanisms

associated with quantum enhanced reaction dynamics including non-adiabatic coupling effects such as the geometric (Berry) phase.

Benefit to National Security Missions

The proposed research will develop new fundamental capabilities in modeling and simulation which will enable the thorough investigation of molecular collisions and chemical reactions in the new unexplored cold energy regime. In addition, the proposed work will also lay the foundation for several potential technological applications based on cold molecules including a new framework for realizing quantum computing, the development of sensors with unprecedented sensitivity, enable new tests of fundamental symmetries, and the synthesis of specific molecular species and materials with novel properties. The control of cold molecular collisions will also enable the formation of dense ensembles of cold molecules relevant for studying new exotic states of condensed matter and quantum phases. Fundamental understanding and reaction cross section calculations of cold molecular collisions are also important in astrophysics models for the interstellar medium and molecular clouds. Relevant agencies include DOE's office of Basic Energy Sciences, NASA, and the Offices of Army and Naval research. Recently, the Army Research Office (ARO) has recognized the importance of this new area of research and has launched a major MURI experimental effort "Quantized Chemical Reactions of Ultracold Molecules" within the university community.

Progress

- Completed the quantum reactive scattering calculations for the $\text{O} + \text{OH} \rightarrow \text{H} + \text{O}_2$ reaction at cold and ultra-cold collision energies which include geometric (Berry) phase effects (due to non-adiabatic coupling between the nuclear and electronic motions). Performed numerous

convergence studies with respect to the basis set size, propagation distance, number of coupled channels, and other parameters. A large number of sensitivity studies were also performed with respect to the potential energy surface in order to help elucidate the possible role that quantum resonances play in the geometric phase effects. Baseline calculations which do not include the geometric phase were also performed for comparison. The geometric phase was found to alter the ultra-cold reaction probability by up to two orders of magnitude and must be included in order to predict the correct experimentally observable cross sections. These calculations are “first ever” benchmark calculations and the large geometric phase effect found at ultra-cold collision energies represents a major discovery in the field of ultra-cold physics. These results are being prepared for publication in either Physical Review Letters or Science.

- Implemented a ScaLapack (parallel) version of the log-derivative propagator for the asymptotic propagation using Delves channel basis functions.
- Implemented and benchmarked a GPU (parallel) version of the computationally intensive matrix-vector-multiply routine. These new capabilities (#2 and #3) enable the solution of an unprecedented large number of coupled channel equations which is needed for including electromagnetic field interactions in the scattering calculations.
- Completed the derivation and numerical implementation of the coupling matrix elements due to external electric fields. The testing and validation of the new computer codes which include these couplings are underway for the Li + HF system.
- Continued active collaboration with Professor Balakrishnan (UNLV) on ultra-cold molecular collisions. Mentored a new UNLV postdoc Jisha Hazara in learning how to perform quantum reactive scattering calculations for the O + OH and Li + LiYb systems.

Future Work

- Finalize the geometric (Berry) phase calculations for the O + OH reaction by including several values of total angular momentum (to verify convergence with respect to the partial wave sum). Prepare and submit manuscript for publication in Physical Review Letters or Science (during Fall/Winter FY15).
- Implement a GPU (parallel) version of the linear-solver in the log-derivative solution of the coupled-channel equations (during Fall/Winter FY15).
- Perform quantum reactive scattering calculations including external electric field interactions for the Li + HF system at ultra-cold energies. Demonstrate electric field control of the reaction outcome. Prepare

manuscript for publication (Winter/Spring FY15).

- Implement external magnetic field interactions and perform additional scattering calculations and control demonstrations for the Li + HF system (Spring/Summer FY15). Prepare results for publication. The Li + HF calculations will validate the new electromagnetic field interactions recently added to the LANL APH3D code against previously published results as well as extend them to new higher collision energies. These will be first ever benchmark calculations and are expected to have high impact within the cold-physics community.
- Perform scattering calculations for the LiNa + LiNa system including external electric fields and investigate stereodynamic control of the outcome (Summer FY15). Prepare results for publication. The LiNa calculations will be first-ever benchmark calculations demonstrating stereodynamic control using external electric fields.
- Present results of the O + OH and Li + HF calculations during the 46th annual meeting of the Division of Atomic, Molecular and Optical Physics of the American Physical Society (June 2015).
- Continue active collaboration with Professor Balakrishnan (UNLV) and postdoc Jisha Hazara (UNLV) on ultra-cold molecular collisions.

Conclusion

The results of this work will revolutionize the field of cold and ultra-cold physics by enabling an efficient treatment of full-dimensional 3-body reactive scattering collisions up through the cold temperature regime including electromagnetic field interactions. We expect to demonstrate control of cold molecular collisions and chemical reactions for several experimentally relevant molecular systems. Since the cold energy regime is essentially unexplored, all of the proposed calculations using this new capability have significant potential for new discoveries and applications.

Publications

Kendrick, B. K., J. Hazra, and N. Balakrishnan. Geometric phase effects on ultracold chemistry. : In preparation for Physical Review Letters, Science, or Nature Physics.

Makrides, C., J. Hazra, G. B. Pradhan, A. Petrov, B. K. Kendrick, T. Gonzalez-Lezana, N. Balakrishnan, and S. Kotochigova. Ultracold chemistry with alkali-metal-rare-earth molecules. Submitted to: The Journal of Chemical Physics.

Pradhan, G. B., N. Balakrishnan, and B. K. Kendrick. Quantum dynamics of O(1D)+D₂ reaction: isotope and vibrational excitation effects. 2014. Journal of Physics B: Atomic, Molecular and Optical Physics. 47 (135202): 1.

Multi-scale Probabilistic Resuspension Modeling of Spores and Radionuclides from Outdoor Surfaces

Michael J. Brown
20140444ER

Introduction

Small micron-sized radiological, biological, and/or heavy-metal-laden particles deposited on urban and rural surfaces during a nuclear or industrial accident, a terrorist attack, or inadvertently as a waste by-product can be resuspended into the air from wind gusts and result in harmful exposures to the population over large areas and long time periods. Particle adhesion to surfaces and the resultant resuspension process is poorly understood, however. Based on assessment of controlled experiments with spherical particles, researchers could not predict the resuspension rate to within a factor of ± 10 and experiments using a biological agent resulted in resuspension rates of up to 1000 times larger than predicted by current theories. This means that current predictive capabilities would not be able to quantify the amount of particles lofted into the air with enough accuracy to determine if the resuspension event was extremely hazardous or not of any concern whatsoever. This uncertainty is a result of a combination of the difficulty in accurately measure particle adhesion, prior focus on idealized spherical particles and smooth surfaces, the lack of bio-agent specific measurements, the inadequacy of current theories for accounting for the sheltering effect of rough surfaces on the aerodynamic lift and drag forces on a small particle, the inherent stochasticity of the adhesion, lift, and drag forces, and the confounding effect of humidity and moisture on adhesion.

This investigation into the fundamental science of resuspension of different particle morphologies from a wide range of surfaces crosses the boundaries of adhesion science and fluid mechanics, and covers a wide range of scales (from nanometers to meters). The resultant algorithms and experimental measurements will improve the resuspension and health risk assessments of those in the bio-terrorism and radiological assessment communities, as well as those working on wind erosion, dust storm, riverine

sedimentology, and clean room applications.

Benefit to National Security Missions

Resuspension of hazardous biological agents and radionuclide particles deposited on indoor and outdoor surfaces plays a role in numerous fields within LANL's national security mission, including counter-terrorism, nuclear power plant safety, plutonium storage, clean-up and remediation, and environmental risk assessment. The resuspension models developed and experimental data collected during this project will be of great interest to DoD, DHS, EPA and intel agencies looking at bio, dirty bomb, and nuclear fallout after-effects, as well as internally at the lab for environmental remediation purposes. There is concern that after a CBR dispersal event that subsequent resuspension could cause significant health effects long after the initial event and complicate clean up efforts. This work will also apply to wind erosion, dust storm, riverine sedimentology, and clean room applications.

Progress

Significant progress has been made on particle resuspension theory and model development. A first generation probabilistic particle resuspension model (PPRM) was coded up following Reeks and Hall (2001) by post-doc Scott Speckart for spherical particles over smooth surfaces. This code accounts for the turbulent variations in the winds and the wide range of adhesion forces found in nature, allowing for plausibly realistic estimates of spherical particle resuspension from smooth surfaces. Additionally, following the direct numerical simulation analyses of Zhang et al. (2013), the model was modified to include more accurate non-Gaussian probability distributions for the aerodynamic lift forces. Scott then developed a particle sheltering algorithm so that the 2nd generation PPRM works over rough surfaces, i.e., surface asperities block the wind so that fewer micron-scale particles are lifted into the air. To our knowledge this is the first-of-its-kind probabilistic

model that can be used over rough surfaces (note that most environmental surfaces are considered “rough”). A first draft of a particle resuspension review paper for the plume modeling community was completed. A second journal paper describing the new particle resuspension model with particle sheltering due to large-scale roughness is underway.

Experimentally, the Center for Integrated Nanotechnology (CINT) team has employed Atomic Force Spectroscopy (AFS) to measure adhesion forces between cantilever probes and surfaces. Initial experimentation has focused on calibration of instrumentation and methodology and hiring key personnel to continue the work. In order to measure adhesion forces between particles and surfaces of interest, we are performing atomic force spectroscopy utilizing an Asylum MFP-3D Stand Alone Atomic Force Microscope (AFM). It is the ultimate goal of this proposal to perform measurements between actual biological samples and natural surfaces, however it is firstly important to calibrate our system by measuring forces between known particles and surfaces in a controlled environment in order to 1) compare to previous literature values and; 2) generate a calibration file from which it is possible to interpret results of actual samples. Thus we have focused on performing calibrated measurements between, for example, Silicon Nitride AFM cantilevers and silicon calibration grids. The AFM topography imaging measurements provide a height section profile demonstrating the sub-nanometer vertical resolution attainable. We have begun collecting force-curves produced at a single position by lowering the AFM probe to the surface and pulling the probe away. By taking such measurements over an entire area we have been able to generate an adhesion force map. These results demonstrate the utility of force mapping via AFS for our proposed work. Accurate measurements rely on proper calibration of each cantilever as the adhesion forces measured are dependent upon the accurate measurement of the spring constant of each cantilever (which we are able to perform using our AFM setup).

While we are initially using pre-loaded cantilevers with attached polymeric and glass beads, it is necessary that we have the ability to also attach our own particles of interest as desired. Thus, we are utilizing a micro-manipulator within the CINT clean room to generate our own probes of interest with desired particles and eventually biological molecules. Initial attempts at adding microspheres to cantilevers are underway. We have also made a key hire in the form of Matt Rush, a graduate student from UNM with a background in Mechanical Engineering and experience in AFM and AFS. He is now working fulltime on the project

and has made great progress in continuing calibration and refinement of our system.

Future Work

- Fully calibrate Atomic Force Spectroscopy (AFS) system and methodology; and perform adhesion measurements of known materials and compare results to both literature values and values obtained via other methods (e.g. sedimentation through centrifugation) that will also be performed by our team. This will ensure confidence in our measurements.
- Perform validation study of second generation probabilistic particle resuspension model (PPRM) combined with first-year AFM-derived adhesion force distributions for “classical” laboratory-scale spherical particle-smooth surface resuspension experiments.
- Produce third generation probabilistic particle resuspension model (PPRM) to account for impact of capillary forces on particle adhesion (i.e., from humidity and moisture). It is known that moisture can result in a water bridge between the particle and surface, significantly increasing adhesion (and reducing resuspension), but the details of when it becomes important is not understood.
- Conduct Atomic Force Microscopy (AFM) adhesion force measurements to characterize probability distribution as a function of asperity roughness height, spacing, particle diameter, and relative humidity.
- Utilize humidity-dependent AFM adhesion force distributions in the 3rd generation PPRM model. Perhaps derive simple expressions for adhesion force pdf as a function of surface, particle asperity characteristics, and relative humidity.
- Conduct AFM nanoscale surface-asperity characterization measurements. This is key for understanding and confirming different models of the particle-surface adhesion force distribution, as well as the nature of the capillary force.
- Begin producing nano-fabricated surfaces and spherical particles with controlled well-defined nanoscale properties. This will allow us to control and isolate parameters that influence adhesion, likely resulting in a better theoretical understanding of the adhesion force between particle and surface.
- Publish journal paper on PPRM with particle sheltering capability.
- Publish conference and journal papers on AFM measurements.

Conclusion

The main goals of the proposed research activity are to:

1) develop “universal” particle resuspension equations that correctly account for adhesion and the quasi-random nature of resuspension and are valid for both rough and smooth surfaces, spherical and non-spherical particles, and dry and humid environments; and 2) to fill in the measurements gap for the mean adhesion force and its probability distribution through first-of-their-kind adhesive force measurements with Atomic Force Microscopy (AFM) using a) nanofabricated particles and surfaces and b) “real” particles (spherical and non-spherical, smooth and rough, biological spores with and without appendages) and “real” urban and rural surfaces.

Publications

Brambilla, S., S. Speckart, and M. Brown. Review: Forces governing particle resuspension for plume dispersion modeling applications. 2014. To be submitted to Atmospheric Environment. 2nd Draft. .

Brambilla, S., S. Speckart, and M. Brown. A review: Quantification of particle resuspension for plume dispersion modeling applications. 2014. To be submitted to Atmospheric Environment. 1st Draft..

Rush, M., P. Adams, and G. Montano. Colloid probe fabrication and calibration. 2014. In preparation. To be submitted to Review of Scientific Instruments..

Speckart, S., S. Brambilla, and M. Brown. Investigation of utilizing theoretical particle resuspension models for rough atmospheric surfaces . 2014. To be submitted to Aerosol Science and Technology, 1st draft..

First Direct Observation of Weibel Instability in Collisionless Shocks

Sasikumar Palaniyappan
20140483ER

Introduction

Acceleration of charged particles as they interact with “collisionless shocks” is a widespread phenomenon occurring across the entire universe. Unlike the well-known collisional hydrodynamic shocks, in the collisionless shocks the particle collision time is much larger than the particle transit time through the shock. This astrophysical phenomenon occurs regularly in the cosmos, for example, at supernova shocks, during fast coronal mass ejection from the sun forming solar-wind shocks and at the planetary bow shocks. A particular type of electromagnetic plasma instability known as Weibel instability is believed to be the dominant mechanism behind the formation of these collisionless shocks in the cosmos. Weibel instability leads to an exponentially growing magnetic field arising from the electromagnetic micro turbulences in initially unmagnetized or weakly magnetized plasmas present in the vicinity of gamma ray burst sources, supernovae and galactic cosmic rays. How these magnetic fields are generated and what are their structures, which dissipation mechanism is dominant, which physical processes lead to shock formation, and how particles are accelerated in these shocks remain open questions. Apart from indirect spacecraft observations, there is no direct observation to date of collisionless shocks mediated by Weibel instability. Here we propose (1) first direct observation of Weibel instability mediated collisionless shocks in laboratory plasmas using ultra-intense lasers and (2) observe the evolution of Weibel instability leading to strong magnetic fields up to few hundred GigaGauss in the plasma using ultrafast proton deflectometry. This will enable us to study the underlying physics behind this unique astrophysical phenomenon.

Benefit to National Security Missions

This project directly aligns with the LANL “Nuclear and Particle Futures” science pillar just established,

specifically with its Nuclear and Particle Physics, Astrophysics and Cosmology, High Energy Density Plasmas, and (Advanced) Accelerators elements. This work will establish a unique LANL capability for studying astrophysical sciences using the existing Trident laser facility. A part of this proposal is to upgrade the Trident probe beam to higher power. Such an addition to the Trident laser facility would greatly enhance LANL scientific capability. Studying laboratory astrophysics with intense lasers is at the heart of the LANL proposal High Intensity Laser Laboratory (HILL), just submitted to the recent NNSA Experimental Science Facilities call, and squarely along the path of the LANL Laser Strategy.

Progress

We proposed to use the near-critical plasmas that are on the verge of the laser reflection/transmission boundary for generating collisionless shocks driven by intense laser pulses. Understanding how the near-critical plasmas respond to intense laser pulses is crucial to use them to generate collisionless shocks. In the past year, we have explored the interaction of ultra-intense laser pulses (Trident laser beam) with near-critical density plasmas. As a result we have identified a new laser-plasma interaction regime, where near-critical plasmas trap plasma electrons due to self-generated plasma magnetic field. A manuscript detailing the results titled “Efficient quasi-monoenergetic ion beam from laser driven plasmas” is under review in ‘Nature’ with the PI as the lead author. The results have larger implications in making laser-driven compact ion accelerators.

As the laser drives a strong electron current forward up to several mega Amperes, it generates a very strong azimuthal magnetic field up to several hundred mega Gauss. As a result the electron current and the laser light are channeled through the plasma. The self-generated plasma magnetic field traps plasma electrons and slows them. The slowed and trapped electrons are released

forward in the end when the laser exits the plasma. The released electrons accelerate the ions to an energetic bunch.

Our team studied the effect of laser spot size on the collisionless shocks driven by intense laser pulses using the VPIC code. At the Trident laser facility, the laser beam can be focused down to a spot size between 5 microns to 20 microns. The spot size could induce transverse instabilities in the plasma that adversely affects the generation of collisionless shocks in the plasma. As a result of the study, we have narrowed down on the optimal laser spot size and the plasma density that would generate the collisionless shocks in near-critical plasmas. We have upcoming beam time at the Trident laser facility that starts in Sep 15th 2014 as part of the FY 14 work. The simulation studies have helped us to design the upcoming experiment. In the experiment, we hope to generate collisionless shocks in near-critical plasmas.

A silica nano-foam near-critical target that is crucial for the experiment was developed. We have collaborated with LANL MST-7 to produce these nano-foams that we plan to use in the upcoming Trident experiment. These silica aerogels are initially formed, then super critically dried, allowing no shrinkage while providing great flexibility in the density. These foams are nanoporous with open celled structure.

In the past year, we have also explored the options of developing a dedicated probe laser beam at Trident versus splitting up the existing Trident laser beam into two. The studies have shown that it is better to split the Trident laser beam in to two for practical reasons. So we will isolate a 3 inch middle portion of the Trident 'C' beam and focus it with a separate off-axis parabola for generation of a proton beam to probe the plasma.

Future Work

A substantial amount of effort will be dedicated to developing a probe laser beam that will be used for proton deflectometry in the second year of the project. We have explored the available options such as developing a dedicated probe beam versus splitting a fraction of the existing Trident short pulse beam and using it for proton deflectometry. After careful study, we have decided that splitting the existing Trident laser beam into two, one beam as a driver and the other beam as a probe would be suitable for the proposed research. A three-inch central portion of the Trident 'C' beam will be sampled and focused using a separate off-axis-parabola for probing the plasma shocks.

Also, the kinetic Vector-Particle-In-Cell (VPIC) simulation the experiments will be continued to improve our understanding of the plasma shock physics.

Conclusion

We expect to see the first-ever direct observation of collisionless shocks mediated Weibel instability in plasmas using 200 Terawatt LANL Trident laser, capable of producing ultra-high intensity of 2×10^{21} W/cm². Using proton deflectometry we expect to measure the magnetic field generated Weibel instability. By measuring the Weibel magnetic field as the time evolves, we could infer the growth rate of the Weibel magnetic field. Diagnosing the ions accelerated by the shock will be one of the main goals of this project. We expect the collisionless shock to accelerate plasma ions to quasi-mono energetic distribution.

Publications

Palaniyappan, S., C. Huang, D. C. Gautier, C. E. Hamilton, J. A. Cobble, C. Kreuzer, R. C. Shah, and J. C. Fernandez. Magnetic Electron Trapping Generates Efficient Quasi-monoenergetic Ion Beam from Laser-driven Plasmas. To appear in Nature Physics (Under second round of review).

New Chemistry Towards High Purity Uranium and Thorium Nitrides

Jacqueline M. Veauthier
20140504ER

Introduction

The purpose of this project is to investigate the fundamental chemistry of uranium and thorium with nitrogen rich ligands using experimental and computational chemistry methods. We propose a series of nitrogen-rich ligands that will bind to uranium and thorium to form novel high nitrogen content actinide coordination compounds. These nitrogen-rich actinide complexes are designed to undergo a low energy initiated self-sustained combustion reaction to yield high purity uranium and thorium nitrides. While there has been an increase in research on new routes to actinide nitrides, there are very few examples of actinide high nitrogen complexes. Characterization of this new class of actinide complexes and subsequent investigation of their combustion properties will impart new insight into their potential application in actinide nitride nuclear fuel fabrication. Concurrently, this research will increase our overall understanding of structure-function relationships as they relate to high nitrogen actinide materials and their decomposition products. Finally, this work will unite LANL core capabilities in actinide and energetic materials chemistry to establish a new LANL capability, a new field of science and could ultimately lead to a revolutionary route to high purity bulk actinide nitrides.

Benefit to National Security Missions

LANL is an international leader in both actinide and energetic materials science. By uniting these two fields, this project offers promise for a new paradigm for the preparation of high purity bulk actinide nitride materials. It will produce high impact results, new signatures of science, train the next generation of actinide scientists, and stands to revolutionize production of advanced nuclear fuel materials. The marriage between actinide and energetic materials that the success of this project demands is uniquely available at LANL. This effort supports the LANL missions in Materials for the Future and in Global Security. We anticipate that our LDRD

successes will translate into a larger program in actinide nitride science with future programmatic funding from organizations such as DOE science campaigns, DNDO, DHS and the IAEA.

Progress

We prepared and characterized two different uranyl high nitrogen complexes of bitetrazoleamine. These include a monomeric and dimeric complex in which each uranium center binds to one bitetrazoleamine as a bidentate ligand. We have shown that we can control formation of the dimer or monomer by controlling the pH of the reaction solution. We are scaling the monomeric compound for combustion experiments. We have also been performing reactions of oxygen-free uranium precursors with nitrogen-rich tetrazole ligands with uranium and thorium and have isolated and characterized a new oxygen-free U(IV) compound that binds 2 nitrogen-rich tetrazole ligands and are working to purify and characterize other U and Th nitrogen-rich compounds from these experiments. This work will be continued and is expected to yield new precursors for combustion experiments in year two.

Towards the computational effort, we have developed a validated computational procedure for investigation of nitrogen rich metal complex decomposition pathways. This method is being used to compare lanthanide and actinide high nitrogen complexes for prediction of complexes that decompose to metal nitrides.

Two postdocs were hired to start in the third quarter of this fiscal year. Kevin Browne of C-IIAC will be working on nitrogen rich uranium and thorium compounds and Katie Maerzke (T-1) will be performing the computational work.

Future Work

Computational and experimental work on novel high

nitrogen complexes of uranium and thorium will continue into Year 2. We will build on our synthetic success in year 1 to scale-up new complexes for combustion experiments which will begin this fiscal year. We will continue to predict stable nitrogen rich uranium precursors and compute energetically favored decomposition pathways.

Milestones for this year include a report that compares the predicted thermal stability of uranium and thorium high nitrogen complexes. Additionally we will report on the synthesis and combustion of new uranium and thorium high nitrogen precursors.

Conclusion

We will prepare novel nitrogen-rich U/Th complexes. Decomposition of these U/Th complexes should give pure U/Th nitride, oxynitride, or oxide materials. We anticipate that the decomposition of oxygen free U/Th high nitrogen compounds to the nitride will take place at low temperatures and will not be plagued with carbon and oxygen impurities. The proposed work will not only result in a new LANL capability, but a new field of science. It will produce high impact results, train the next generation of actinide scientists, and offers to ultimately revolutionize production of advanced nuclear fuel materials.

Discovery and Implication of Negative Ions in the Earth's Magnetosphere

Herbert O. Funsten
20140546ER

Introduction

After more than 50 years of intensive study, our lack of understanding of mass and energy transport throughout the magnetosphere as well as the underlying physical processes that drive them is astounding: we still cannot predict geomagnetic storm onset, evolution, magnitude, and persistence. Using recent spacecraft data, we have serendipitously discovered negative hydrogen (H⁻) and (O⁻) ions at energies up to 50 keV. Because they (1) likely originate as cold ions in the upper ionosphere, (2) behave differently than positive ions in electromagnetic fields, and (3) respond differently than electrons to waves, these particles represent a fundamentally new and unique population. Key questions that our project will answer include:

- What are the origin, transport, acceleration, and fate of H⁻ and O⁻ in the magnetosphere?
- What physical processes are revealed and understood using H⁻ and O⁻ as signatures?
- What is the global impact of H⁻ and O⁻ on mass and energy flow throughout the magnetosphere?

Benefit to National Security Missions

This project provides new signatures for understanding physical processes that drive the dynamics of the Earth's space environment and will quantify the impact of these new particle species on the physical processes themselves. Understanding and predicting the space environment is directly applicable to our DOE space Nuclear Detonation Detection Program and is of interest to other agencies who rely on the U.S. space infrastructure. Furthermore, it is directly relevant to NASA's mission of understanding the space environment under its Living with a Star Program.

Progress

Work to date during FY14 has focused on three key tasks in order to establish the credibility that the negative ion

signatures observed by the HOPE mass spectrometer are of natural (ionospheric) origin.

Quantification of electron backgrounds

The HOPE mass spectrometer uses energy and time-of-flight (TOF) measurements to establish the mass of a charged particle. The primary background for negative ions is dependent on the electron flux, specifically chance TOF coincidence resulting from two electrons that generate non-coincident detection events at a TOF value characteristic of a negative ion. Using the TOF spectra that are routinely reported from HOPE, we have quantified the probability of electron chance coincidences occurring within negative ion TOF windows for negative H and O as a function of energy and over 6-month epochs. The negative ion counts (but not flux) corrected for the chance-coincidence electron background have been incorporated into the HOPE data processing chain and are now available as a data product for analysis by this project team. We have demonstrated the ability to remove most counts from chance detection of two electrons. Because the HOPE TOF spectra are only obtained for a subset of viewing angles and thus represent only 1/40 of all collected data, we will validate the electron background using the entire HOPE data set using negative ion counters, which have been re-set on the spacecraft to accurately map to either negative ion TOF spectra (at the appropriate H⁻ and O⁻ energy range) or to collection of background counts (outside of this energy range).

Quantification of negative ions generated within the HOPE instrument

Scattering of ambient positive ions from internal surfaces of the HOPE instrument represents the only viable potential pathway for non-natural negative ion production and subsequent detection by HOPE. Specifically, the entrance surface to the HOPE electrostatic energy analyzer contains a potential scattering surface at an Al plate coated with Ebonol-C

(dendritic copper-black). We have performed both electron-optic simulations of this scattering and laboratory experiments of scattering of an incident beam of 10 keV H⁺ from this coated surface. The electron-optic simulations have identified Ebonol-coated Aluminum zones of the HOPE entrance that can scatter incident protons such that resulting negative ions can enter and traverse the energy analyzer. The experiment uses an electro-static deflection and an imaging microchannel plate detector to measure the incident beam flux, the distribution of scattered atoms, the energy of the scattered atoms (crudely), and the charge state of the scattered atoms. The following key results were obtained, indicating predominantly specular scattering:

- The scattering probability of incident protons is 0.0113 at an incident angle of 10° and 0.0058 at an incident angle of 20°
- The fractional charge state distribution of scattered hydrogen at an incident angle of 10° is: 0.14 H⁺; 0.85 H⁰ (neutral), and 0.01 +/- 0.002 H⁻
- The fractional hydrogen abundance with energy loss of the scattered hydrogen is minimal: 0.86 lose no/ minimal energy, 0.10 lose up to 1 keV; and 0.04 lose between 1 keV and 4 keV
- The net probability that an incident H⁺ is scattered as H⁻ is therefore $(0.0113 * 0.01) = 0.00011$.

Quantification of the absolute detection efficiency of negative ions

These tests utilize the HOPE engineering (non-flight) model of a single TOF pixel. This experiment, originally to be completed in FY14, will extend into FY15 because of reduced LDRD funding (as previously reported to the LDRD PO). Preliminary results indicate that the coincidence detection efficiency of negative ions is approximately half that of positive ions; this difference is the result of the different acceleration voltage for charged particles in ion mode (11 kV) and electron mode (1.5 kV).

The impact of LDRD cuts on this project is minimal; as previously reported, experiments of quantification of negative ion fluxes as a HOPE data product will be complete in early FY15. A critical person for implementing this (Jon Niehof) has left the Lab but will still be available at a low level to complete this implementation. A summer student (Kyle Pittman) is helping to understand the electron backgrounds. Co-I Brian Larsen is preparing a manuscript on the scattering of protons from Ebonol-coated aluminum.

Future Work

The second year of this project involves the quantification of negative ions generated within the HOPE instrument and contribution from the natural environment. With the experimental validation of the electron background complete, quantification of the negative ion measurement begins. Negative ions are certainly created through scattering within the instrument but laboratory measurements show vastly insufficient efficiency to explain the measured signal. As the natural negative ions quantified estimates are completed the O⁻ and H⁻ lifetimes in the magnetosphere will commence. These are exciting missing pieces of information as published solar negative ion lifetimes are far shorter than required for our magnetospheric observations. We expect several discovery-class publications as the quantifications are completed.

Conclusion

We will characterize the H⁻ and O⁻ abundances as a function of time, location, energy, and geomagnetic activity; demonstrate their utility as enabling, unique signatures for magnetospheric dynamic processes; utilize these signatures to study a subset of these processes; and demonstrate whether (or not) they are of sufficient abundance to influence the physical processes driving mass and energy transport in the magnetosphere. This has the potential to open a new subfield in magnetospheric physics, with instrumentation designed specifically for measurement of negative ions on future missions.

Viral Disarmament: A Trojan Protein Approach

Murray A. Wolinsky
20140558ER

Introduction

Viruses evade our defenses by evolving rapidly. Typically, viruses evolve about a million times faster than the human genome. Consequently, few effective antiviral therapeutics exist. We need new antiviral strategies that turn viral evolution from an advantage into a handicap. Our effort will determine rates of viral mutation and loss of function under conditions where selection pressure has been removed, and will potentially enable new antiviral therapeutic strategies.

We have four aims:

- Learn how quickly a viral gene can become nonfunctional. We propose to determine rates of viral evolution by providing supplements (“Trojan proteins”) that eliminate the need for viral genes to produce their protein products.
- Examine the effects of viral mutations on viral function.
- Separate roles of viral genomic RNAs (vgRNAs).
- Obtain distributions of mutations (counts by genomic location) for viruses that preserve function and for those that lose function.

Our effort is the first effort, to our knowledge, to quantitatively study, in a controlled fashion, a counter-intuitive effect whereby evolution can lower (not raise) fitness. Our particular approach to studying this phenomenon involves “flattening” the fitness landscape in which viruses produce their needed proteins. We remove selection pressure on two viruses by studying infections in host cells that have been modified to produce proteins that the viruses normally synthesize. We call these proteins “Trojan” proteins, because, while they initially benefit the virus, ultimately they are intended to lead to a dependency on the host; and upon removal, to the collapse of the viral population. If results are promising, we believe that a new avenue of viral therapeutics will be enabled.

Benefit to National Security Missions

Joshua Lederberg wrote “The single biggest threat to man’s continued dominance on the planet is a virus.” Still, very few antiviral drugs exist. Both biodefense and public health missions require that we develop better antiviral agents.

Understanding viral evolution is essential. It is natural also to consider whether viruses ability to evolve rapidly can be used against them. The proposed effort is fundamental science and will provide important insight into mutational loss of function. It may lead to new therapeutics or new therapeutic strategies. Our approach should be of immediate interest to NIH, to NSF, and to DARPA. As the work progresses, and applications become feasible, it should become relevant to the missions of DTRA and to the DHS.

Progress

- Obtained IBC approval (IBC 130/Viral disarmament: a Trojan protein approach/Momchilo Vuyisich/Murray Wolinsky/29 January 2014). Set up a dedicated lab, and hired Anaïs Weibel, a (master’s degree) virologist affiliated with the Institut Pasteur to perform the experimental work. Trained Anaïs in methods needed specifically for this effort. Obtained additional summer student support and applied for director’s funded postdoctoral fellow.
- Collaborated with Susan vandeWoude’s group at Colorado State University for feline immunodeficiency virus work. (Experimental work to be performed in Year 2.)
- Selected influenza A virus strain for experiments: Influenza A /California/07/2009 strain (H1N1). Began experimental work on this virus with assistance from Jennifer Harris. Selected host cell lines: MDCK cells and Beas-2b cells.
- Discussion with experts and literature analysis indicated that five proteins are particularly suitable

for initial experiments: PB1, PB2, PA, HA, and M1. We codon-optimized nucleic acid sequences corresponding to these proteins, and ordered and received corresponding sequences for host expression. Codon-optimization will improve protein expression levels and, more importantly, will allow us to differentiate viral sequences (including mutated viral sequences) from host-produced sequences. We performed statistical analyses that verify we will be able to distinguish the sources of these proteins for expected mutation rates and regardless of expected sequencing error rates.

- All host cells have been transfected with all the influenza genes selected. We isolated MDCK clones for the M1 gene (MDCK-M1) and started to analyze the gene expression level and protein length by ELISA and Western-Blot techniques. The selected clones will be propagated in large quantities and stored for future virus propagation.
- We expect to have a qPCR assay for influenza viruses in the next month to start the virus propagation. (Jason Gans designed an initial influenza A qPCR assay. This assay has been tested and we are currently iterating on the design to improve its performance.) This qPCR assay will provide a faster way to quantify the virus for the serial infection than the immuno-plaque assay we are currently using.
- We expect to obtain stable clones expressing each of our initially-targeted viral genes during this summer for both MDCK and Beas-2b cell lines.
- We hope to start the virus propagation on MDCK-M1 cells before August and have the first sequencing result during September.
- With substantial assistance from Jason Gans, we set up an initial analysis platform for transcriptomic data to detect and characterize viral mutations. As a test, we collected sequence data from both uninfected and infected host cells to develop methods of mapping reads to distinguish host cell (background) sequences from viral sequences. Our platform uses widely-used transcriptomic analysis tools (Bowtie 2, Cufflinks, Tophat 2) as well as custom scripts and other tools. Our mapping methods are currently being refined.
- Updated initial model and simulations that were the basis for this effort. Advanced collaboration with Eugene Shakhnovich at Harvard regarding modeling issues and analysis of expected experimental data through telephone conversations. Currently working on manuscript for publication.
- Exploring potential developments of this work for related applications with Joel Berendzen. Submitted pentachart to DARPA for follow-on activities. Have identified a potential collaborator for follow-on animal

work for NIH proposal if experimental results are adequately promising.

Future Work

We will study two viruses: feline immunodeficiency virus and influenza A virus. Work on influenza A virus was started in year 1. Work on feline immunodeficiency virus will be initiated in the next FY. For each viral protein we will develop host cell lines (where feasible) that endogenously express the viral protein. (Currently this has been done for five initial influenza A viral proteins.) In serial passage experiments, these host cell lines will be infected by these viruses, allowing us to study the effects of supplementation on viral evolution. We expect these experiments will generate “replication-deficient” viruses. Existing and new theoretical methods will be used to identify the mutations responsible for loss of function. In the second year, we will:

- Continue the viral passaging experiments with avian influenza virus on identified host cell lines for 5 selected proteins.
- Obtain sequence data for these proteins as a function of passage number, and determine amounts and rates of mutation.
- If loss of function is observed in any of these proteins, identify mutations responsible for this loss of function. (This is the central goal of the project: to obtain “replication-deficient” viruses.)
- Establish robust platform for analysis of sequencing results.
- Share material and data with Eugene Shakhnovich.
- Expand experimental work to remaining influenza A proteins.
- Expand experimental work to feline immunodeficiency virus.
- Publish experimental/theoretical results.

Conclusion

The core innovation is methodological. We propose a new way to study viral evolution; in particular, loss of viral function. Our methodology is based on providing host cells with the same proteins that the viruses naturally produce. By doing so, we “flatten” the fitness landscape. This methodology provides a research platform of considerable generality to study [i] progression towards loss of function, [ii] specific mutations responsible for loss of function, [iii] number of mutations required for loss of function, and [iv] rate of loss of function. Perhaps paradoxically, our approach also may provide novel viral therapeutics.

Understanding Earth's Deep Water Cycle: Neutron Diffraction and Calorimetric Studies of Hydrus Minerals

Hongwu Xu
20110190ER

Abstract

As part of the global hydrologic cycle, the Earth's deep water cycle plays a significant role in many geological processes, including arc volcanism, deep focus seismicity, and, in a larger context, the evolution of our planet. To understand Earth's deep water cycle, it is essential to determine the stability and fate of hydrous minerals, which occur in hydrated oceanic crust, when the crust is subducted into the mantle via the mechanism of plate tectonics. The objectives of this research are to characterize the crystal structures, elastic properties and thermodynamic stability of a number of hydrous minerals at high-temperature (T) and/or high-pressure (P) conditions using several experimental techniques including neutron diffraction, synchrotron X-ray diffraction (XRD) and infrared spectroscopy (IR). We have investigated two groups of minerals: 1) simple hydroxides such as brucite and nickel hydroxide; and 2) complex hydrous phases including jarosite and magnesium silicate phase A. Since these minerals contain large amounts of hydrogen, neutron diffraction is particularly powerful for such studies. Systematic neutron measurements have yielded valuable information such as hydrogen positions and displacement parameters as a function of P and/or T that are difficult to obtain with other techniques. Synchrotron-based methods (XRD and IR) can provide complementary information, especially at higher pressures, due to the high brightness of synchrotron radiation and the ease of combining it with diamond-anvil cell (DAC). The obtained results provide important parameters for models of Earth's deep water cycle and thus shed light on mechanisms underlying the storage, fate and dynamics of water in the Earth's interior.

Background and Research Objectives

Comparative planetology has demonstrated the uniqueness of our planet, not only in the compositions of its oceans and atmosphere, but also in the ways in which it continuously renews its surface through plate tectonics. The latter arises from convective motions in

the viscous silicate mantle and is governed by mantle viscosity, elasticity, and mineralogy. The existence and distribution of volatile species, including water, in Earth's interior strongly influence the global tectonics and related geological processes such as seismicity and volcanism [1-7]. The amount of hydrogen in the deep Earth largely depends on the manners it can be accommodated in the structures of mantle minerals. The origin and history of the hydrosphere may also depend on the primary reservoir of water in the mantle. Furthermore, it has long been recognized that the density and seismic velocities in Earth's core require it to be iron alloyed with lighter elements such as H, C and S [8]. During the past decades, the mechanism of water exchange between lithosphere, hydrosphere, and biosphere has generated considerable interest in the scientific community at large [9].

The most common hydrous minerals in Earth's crust include clay, mica, amphibole and serpentine. Previous studies show that these minerals are stable to depths of ≈ 200 km [1]. At greater depths, they dehydrate, and new hydrous phases, especially dense hydrous magnesium silicates, will be formed [10-11]. In addition, hydrogen can be stored in the structures of nominally anhydrous minerals, such as olivine, pyroxene and ringwoodite, which also occur at depths >200 km [1,12]. Hence, the existence of hydrogen in these minerals may have significant effects on the evolution and dynamics of the mantle. Despite its importance, information regarding hydrogen bond behavior at high P-T conditions is scarce, and thus the detailed structures and stability of many hydrous minerals in the deep Earth remain largely unclear.

The goals of this project are to unravel atomistic mechanisms underlying the behavior of hydrous minerals at high P and/or T via studying their crystal chemistry and thermodynamic stability. Using neutron diffraction coupled with our developed high P-T technique, and

synchrotron X-ray diffraction and infrared spectroscopy, we have determined crystal structures, elastic properties, and thermodynamic stability of a number of hydrous minerals at high P-T conditions. In particular, we have characterized hydrogen bonding in these minerals, which plays a key role in their thermodynamic stability, dehydration processes and phase relations. These studies provide fundamental information on structure features that permit hydrogen to be retained under extreme P-T and thus shed lights on the mechanisms of water cycling in deep Earth and the origins of the arc volcanoes and deep focus earthquakes.

Scientific Approach and Accomplishments

To achieve the above objectives, we have performed the following tasks: 1) sample syntheses of brucite [Mg(OD)₂], nickel hydroxide [Ni(OD)₂ and Ni(OH)₂], jarosite [KFe₃(SO₄)₂(OD)₆] and hydrous phase A [Mg₇Si₂O₈(OD)₆]; 2) neutron diffraction of the four phases; 3) synchrotron XRD of nickel hydroxide and jarosite; and 4) synchrotron IR of hydrous phase A. These neutron and synchrotron experiments were conducted at high-P and/or high-T conditions.

Sample Syntheses: As hydrogen has a high incoherent scattering cross section for neutrons, which causes high backgrounds in neutron diffraction patterns, we synthesized deuterated phases instead [except nickel hydroxide, for which both Ni(OD)₂ and Ni(OH)₂ were prepared]. The Mg(OD)₂ sample was prepared from hydrothermal reaction of high-purity MgO powders with D₂O in an autoclave at 548 K for ~20 h. Similarly, the KFe₃(SO₄)₂(OD)₆ sample was made from hydrothermal reaction of Fe(NO₃)₃·9D₂O, K₂SO₄ and D₂O at 433 K for 3 days. To investigate H/D isotope effect, Ni(OD)₂ and Ni(OH)₂ samples were prepared using precipitation methods with Ni(NO₃)₂·6H₂O, NaOH and H₂O or their deuterated counterparts as starting chemicals. The Mg₇Si₂O₈(OD)₆ sample was synthesized using the high P-T method with a Kawai-type multi-anvil apparatus. Starting material was a mixture of natural forsterite (Mg₂SiO₄) and Mg(OD)₂ in a molar ratio of 2:3, and 16 runs were conducted. In a typical run, the starting material and D₂O water were loaded into a platinum capsule and were held at 10 GPa and 1073 K for 5 hours, followed by quenching to room temperature at 10 GPa and decompression to ambient pressure. All the obtained samples were confirmed to be phase-pure by powder XRD.

Neutron Diffraction of Brucite: Two types of time-of-flight neutron experiments were performed on Mg(OD)₂: 1) high-T measurements from 313 to 583 K [13]; and 2) high P-T measurements up to 5 GPa and 1000 K. Our high-T neutron patterns indicate that Mg(OD)₂ was stable from 313 to 553 K. However, the sample partially decomposed

into periclase (MgO) and D₂O (gas) when T = 583 K. Thus the onset temperature of the dehydroxylation lies between 553 and 583 K. Rietveld analyses of the obtained neutron data were performed using both single-site and three-site split-atom hydrogen models. The results show that with increasing temperature, unit-cell parameter c increases more rapidly than a; the coefficient of thermal expansion (CTE) along the c-axis is ~5 times that along the a-axis. This large anisotropy of thermal expansion is primarily due to rapid increase in the interlayer thickness along the c-axis on heating. The amplitudes of thermal vibration for Mg, O and D increase linearly with increasing temperature; however, the rate of the increase for the lighter D is much larger (Figure 1). In addition, D vibrates anisotropically with a higher magnitude within the (001) plane. On heating, the interatomic distances between a given D and its associated O and D from the adjacent [MgO₆] layer increase, whereas the O-D bond length decreases (Figure 2). This behavior suggests weakened D···O and D···D interlayer interactions but strengthened O-D bonding with increasing temperature.

Several sets of high P-T neutron experiments were carried out on Mg(OD)₂. Specifically, the sample was first compressed to a certain pressure and then at that pressure, was heated up to 1000 K. For example, one set of experiment was conducted at about 0.8 GPa and 298, 500, 700, 800, 900 and 1000 K. The neutron patterns indicate that Mg(OD)₂ was stable up to 900 K at 0.8 GPa. However, the sample partially decomposed into periclase (MgO) and D₂O when T = 1000 K. Thus the onset temperature of the dehydroxylation at this pressure lies between 900 and 1000 K, which is much higher than that at ambient pressure (between 553 and 583 K). This behavior suggests that the Mg(OD)₂ dehydroxylation displays a normal, positive P-T slope. Rietveld analysis reveals that with increasing temperature, the c dimension expands at a larger rate than a. Similar to the behavior at ambient pressure, this anisotropy of thermal expansion is due to rapid increase of the interlayer thickness along c with increasing temperature. However, the magnitudes of the thermal expansion are smaller than those at room pressure, apparently due to the pressure confining effect.

Neutron/Synchrotron X-ray Diffraction of Nickel Hydroxide: We conducted similar neutron experiments on Ni(OD)₂, including high-T measurements up to 500 K and high P-T measurements up to 3 GPa and 600 K (Figure 3). The high-T neutron patterns show that Ni(OD)₂ started to decompose into NiO and D₂O at a temperature between 435 and 453 K. Rietveld analysis reveals similar behavior to Mg(OD)₂ in variations of lattice constants and bonding parameters with T. However, the thermal expansion

anisotropy of Ni(OD)₂ is much more dramatic than that of Mg(OD)₂. The CTE of Ni(OD)₂ along its c-axis is 11 times that along its a-axis, as compared with 5 times for Mg(OD)₂. High-P neutron diffraction results show that with increasing P, cell parameter c decreases much more rapidly than a, which is largely due to rapid reduction of the interlayer spacing, as occurred in Mg(OD)₂. Fitting of the determined cell volumes to a Birch-Murnaghan equation of state yielded a bulk modulus (K₀) of 57.3(1.0) GPa and a zero-pressure volume of 38.33(2) Å³ with K₀' fixed at 4.7 [14]. Moreover, upon compression, the hydrogen-mediated interactions between the neighboring layers become strengthened, as reflected in decreases in interlayer D···O and D···D distances with increasing P. On heating at 3 GPa, the mean volume CTE is 6.58 × 10⁻⁵/K, smaller than 8.95 × 10⁻⁵/K measured at room pressure, which arises from the confinement effect at high P.

Since the reported bulk moduli for nickel hydroxide exhibit a wide range of 52 to 88 GPa [14-15], we conducted a comparative study of Ni(OD)₂ and Ni(OH)₂, which may possibly cause the compressibility discrepancies due to H/D isotope effect. Specifically, we carried out energy-dispersive synchrotron XRD on Ni(OD)₂ and Ni(OH)₂ at identical P-T conditions using a multi-anvil apparatus. Our results show that at a given condition, unit-cell parameters a and c of Ni(OH)₂ are, respectively, larger than those of Ni(OD)₂. The resulted smaller unit-cell volumes for Ni(OD)₂ imply that the structure may preferentially incorporate D over H at high pressures. Furthermore, Ni(OD)₂ is only slightly more compressible than Ni(OH)₂ (primarily along the c-axis). Thus the discrepancies in reported bulk moduli are not due to H/D isotope effect. The larger bulk modulus obtained from DAC measurement [15] is likely due to nonhydrostatic conditions in the DAC plus its radial diffraction geometry. In a typical DAC setup, as the diffraction plane is parallel to the pressure loading direction, the data collected under nonhydrostatic conditions will measure diffraction from the minimum stress direction and lead to an erroneously larger bulk modulus. By contrast, our toroidal-anvil-cell neutron experiment was hydrostatic, because the sample was pre-annealed at high temperature to release nonhydrostatic, deviatoric stresses.

Synchrotron X-ray/Neutron Diffraction of Jarosite: To map out jarosite [KFe₃(SO₄)₂(OD)₆] P-T stability regions [16], several sets of measurements were performed up to 9 GPa and 1273 K. For example, at 9.1 GPa, jarosite was stable up to 824 K, but then decomposed partially into yavapaiite, hematite and water at 839 K. This dehydroxylation temperature is higher than that at ambient pressure (between 550 and 575 K) [17], suggesting a positive P-T slope for the dehydroxylation reaction. At a given pressure, the c dimen-

sion of jarosite expands at a rate more rapidly than that for a. Similar to the behavior at room pressure [17], this anisotropy is largely due to the ease of tilting the Fe(O,OD)₆ octahedra about the a-axes, which results in rapid increase in the (001) layer thickness with temperature. However, because of the confining effect, the magnitudes of the thermal expansion are smaller than those at ambient pressure.

Synchrotron IR Spectroscopy and Neutron Diffraction of Hydrous Phase A: IR spectra of Mg₇Si₂O₈(OD)₆ were collected from 600 to 8000 cm⁻¹ in frequency at pressures up to 31 GPa (Figure 4). Although the sample is nominally a deuterated phase, the IR spectra indicate that it contains a small amount of OH, presumably due to the exchange of D by H from moisture during sample synthesis/handling. Because IR spectroscopy is more sensitive to OH than OD, the presence of even a small amount of OH results in significant IR signals arising from OH. Thus the sample can be used for studying both OD and OH vibrational properties. The results suggest a possible phase transition at 12 GPa, as evidenced by the slope changes in variations of OH/OD band frequencies with pressure. High P-T neutron diffraction experiments of Mg₇Si₂O₈(OD)₆ were conducted up to 2 GPa and 958 K. The obtained patterns indicate that this phase remained stable throughout the P-T range tested, demonstrating the high hydrogen-bonding strengths [18] at these conditions.

In summary, simple hydroxides such as brucite and nickel hydroxide are present as component units in the structures of complex hydrous mantle minerals (such as phase-E, Mg_{2.08}Si_{1.16}H_{3.20}O₆), and hydrous phase A is a potential host phase for water in the Earth's mantle. Jarosite occurs on Mars, which is considered as a strong evidence for the existence of water (and life) in ancient Mars. Hence, studying the structures and stability of these minerals at relevant P-T conditions will provide important insights into the mechanisms of water storage in the deep Earth and other planets (if the same tectonic mechanism is operating in Mars).

Impact on National Missions

Through determining the structures and stability of a number of hydrous minerals at high P and/or T conditions, this project contributes to fundamental understanding of the storage and fate of Earth's deep water and related geological activities including volcanism and seismicity. Earth's deep water cycle is an essential part of the global water cycle which integrates physical, chemical, and biological processes that sustain ecosystems and influence climate, hazardous events, and related global change. The unique high P-T neutron technique used/optimized has a

wide range of applications in materials science, physics, chemistry, Earth and environmental sciences, and thus will strengthen key capabilities required for future mission areas in materials research, energy security and environmental remediation.

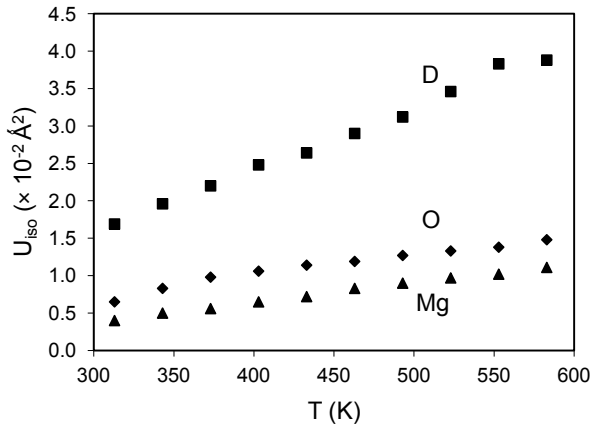

Figure 1. Variation of isotropic thermal parameters (U_{iso}) for Mg, O and D in Mg(OD) as a function of temperature.

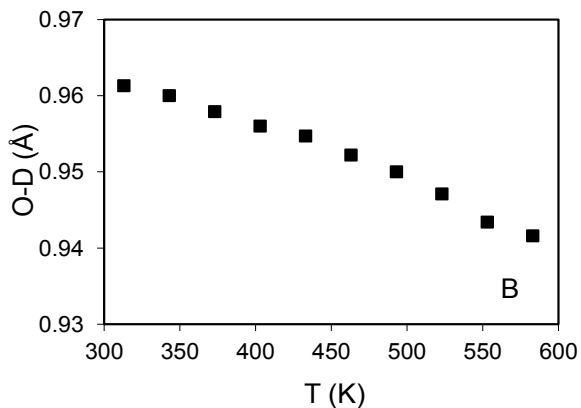
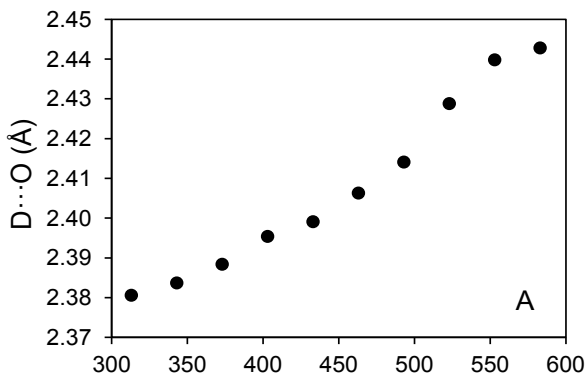

Figure 2. Variation of interatomic distances (A) D...O and (B) O-D in Mg(OD) as a function of temperature.

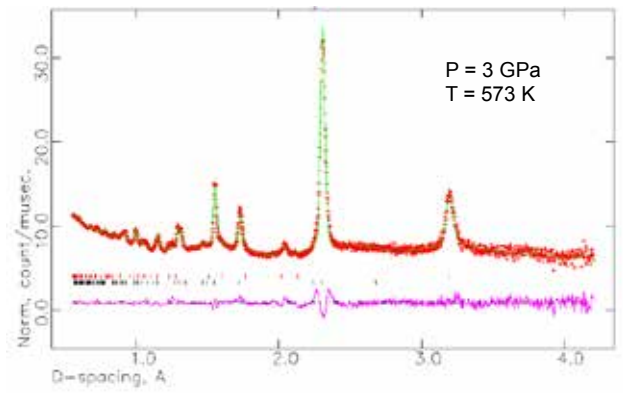

Figure 3. Fitted neutron diffraction pattern of Ni(OD) at 3 GPa and 573 K. Data are shown as red plus signs, and the solid green curve is the best fit to the data. Tick marks below the pattern show the positions of allowed reflections (red - graphite furnace; black - Ni(OD)), and the lower pink curve represents the difference between the observed and calculated profiles.

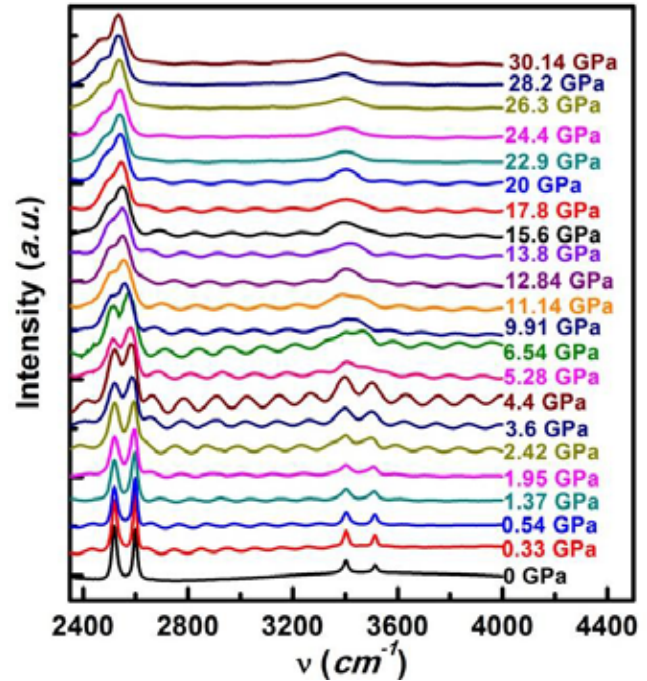

Figure 4. Synchrotron infrared spectra of hydrous phase A [MgSiO(OD)] as a function of pressure.

References

- Jacobsen, S. D., and S. van der Lee. Earth's deep water cycle, Geophysical Monograph 168. 2006.
- Kerrick, D. M., and J. A. D. Connolly. Metamorphic devolatilization of subducted marine sediments and the transport of volatiles into the Earth's mantle. 2001. Nature. 411: 293.
- Hirschmann, M. M.. Water, melting, and the deep

- Earth H₂O cycle. 2006. *Annual Review of Earth and Planetary Sciences*. 34: 629.
4. Thompson, A. B.. Water in the Earth's upper mantle. 1992. *Nature*. 358: 295.
 5. Peacock, S. M.. Are the lower planes of double seismic zones caused by serpentine dehydration in subducting oceanic mantle?. 2001. *Geology*. 29: 299.
 6. Reynard, B., and J. D. Bass . Elasticity of lawsonite and seismological signature of metamorphism and water cycling in the subducting oceanic crust. 2014. *Journal of Metamorphic Geology*. 32 (5): 479.
 7. Brovarone, A. V., and O. Beyssac. Lawsonite metasomatism: A new route for water to the deep Earth. 2014. *Earth and Planetary Science Letters*. 393: 275.
 8. Poirier, J. P.. Light elements in the Earth's core. 1994. *Physics of the Earth and Planetary Interiors*. 85: 319.
 9. Lee, S. van der, K. Regenauer-Lieb, and D. A. Yuen. The role of water in connecting past and future episodes of subduction. 2008. *Earth and Planetary Science Letters*. 273: 15.
 10. Fumagalli, P., and S. Poli. Experimentally determined phase relations in hydrous peridotites to 6.5 GPa and dynamics of subduction zones. 2005. *Journal of Petrology*. 46: 555.
 11. Shieh, S. R., T. S. Duffy, Z. X. Liu, and E. Ohtani. High-pressure infrared spectroscopy of the dense hydrous magnesium silicates phase D and phase E. 2009. *Physics of the Earth and Planetary Interiors*. 175: 106.
 12. Mrosko, M., S. Lenz, C. A. McCammon, M. Taran, R. Wirth, and M. Koch-Müller. Hydrogen incorporation and the oxidation state of iron in ringwoodite: A spectroscopic study. 2013. *American Mineralogist*. 98 (4): 629.
 13. Xu, H., Y. Zhao, D. D. Hickmott, N. J. Lane, S. C. Vogel, J. Zhang, and L. L. Daemen. High-temperature neutron diffraction study of deuterated brucite. *Physics and Chemistry of Minerals*. 40 (10): 799.
 14. Parise, J. B., H. Cox, H. Kagi, R. Li, W. Marshall, J. S. Loveday, and S. Klotz. Hydrogen bonding in M(OD)₂ compounds under pressure. 1998. *Rev. High Pressure Sci. Technol.* 7: 211.
 15. Garg, N., S. Karmakar, S. M. Sharma, E. Busseto, and S. K. Sikka. High-pressure X-ray diffraction studies on beta-Ni(OH)₂. 2004. *Physica B-Condensed Matter*. 349: 245.
 16. Xu, H., Y. Zhao, J. Zhang, Y. Wang, D. D. Hickmott, L. L. Daemen, M. A. Hartl, and L. Wang. Anisotropic elasticity of jarosite: A high-P synchrotron XRD study. 2010. *American Mineralogist*. 95: 19.
 17. Xu, H., Y. Zhao, S. C. Vogel, D. D. Hickmott, L. L. Daemen, and M. A. Hartl. Thermal expansion and decomposition of jarosite: A high-temperature neutron diffraction study. *Physics and Chemistry of Minerals*. 37: 73.
 18. Kagi, H., J. B. Parise, H. Cho, G. R. Rossman, and J. S. Loveday. Hydrogen bonding interactions in phase A [Mg₇Si₂O₈(OH)₆] at ambient and high pressure. 2000. *Physics and Chemistry of Minerals*. 27: 225.
- ### Publications
- Xu, H. W., Y. S. Zhao, J. Z. Zhang, Y. J. Wang, D. D. Hickmott, L. L. Daemen, M. A. Hartl, and L. P. Wang. Anisotropic elasticity of jarosite: A high-P synchrotron XRD study. 2010. *AMERICAN MINERALOGIST*. 95 (1): 19.
- Xu, H. W., Y. S. Zhao, S. C. Vogel, D. D. Hickmott, L. L. Daemen, and M. A. Hartl. Thermal expansion and decomposition of jarosite: a high-temperature neutron diffraction study. 2010. *PHYSICS AND CHEMISTRY OF MINERALS*. 37 (2): 73.
- Xu, H., D. D. Hickmott, Y. Zhao, J. Zhang, Q. Wei, S. C. Vogel, and L. Wang. High-P/T synchrotron X-ray and neutron diffraction study of carbonate minerals. 2010. *GEOCHIMICA ET COSMOCHIMICA ACTA*. 74 (12): A1159.
- Xu, H., D. Hickmott, J. Zhang, Y. Zhao, S. Vogel, and L. Daemen. Structure and stability of nickel hydroxide at high T-P conditions. Presented at Goldschmidt 2011. (Prague, Czech Republic, 14-19 Aug. 2011).
- Xu, H., Y. Zhao, D. D. Hickmott, N. J. Lane, S. C. Vogel, J. Zhang, and L. L. Daemen. High-temperature neutron diffraction study of deuterated brucite. 2013. *Physics and Chemistry of Minerals*. 40 (10): 799.
- Zhu, J. L., H. W. Xu, J. Z. Zhang, C. Q. Jin, L. P. Wang, and Y. S. Zhao. Thermal equations of state and phase relation of PbTiO₃: A high P-T synchrotron x-ray diffraction study. 2011. *JOURNAL OF APPLIED PHYSICS*. 110 (8): 084103.
- Zhu, J. L., S. M. Feng, Q. Q. Liu, J. Z. Zhang, H. W. Xu, Y. C. Li, X. D. Li, J. Liu, Q. Z. Huang, Y. S. Zhao, and C. Q. Jin. Temperature and pressure effects of multiferroic Bi₂NiTiO₆ compound. 2013. *JOURNAL OF APPLIED PHYSICS*. 113 (14): 143514.
- Zhu, J. L., Z. J. Lin, J. Z. Zhang, H. W. Xu, S. C. Vogel, C. Q. Jin,

and Y. S. Zhao. High pressure neutron and synchrotron X-ray diffraction studies of tetragonal $\text{LaFeAsO}_{0.9}\text{F}_{0.1}$. 2012. HIGH PRESSURE RESEARCH. 32 (3): 405.

Zhu, J., J. Zhang, H. Xu, S. C. Vogel, C. Jin, J. Frantti, and Y. Zhao. Pressure-induced reversal between thermal contraction and expansion in ferroelectric PbTiO_3 . 2014. Scientific Reports. 4: Article No. 3700.

Zhu, J., S. Du, X. Yu, J. Zhang, H. Xu, S. C. Vogel, T. C. Germann, J. S. Francisco, F. Izumi, K. Momma, Y. Kawamura, C. Jin, and Y. Zhao . Encapsulation kinetics and dynamics of carbon monoxide in clathrate hydrate. 2014. Nature Communications. 5: Article No. 4128.

Foundational Methods and Experiments in Ultracold Molecular Physics

Michael D. Di Rosa
20110356ER

Abstract

Current trends in publications and shifts in world-wide experimental programs indicate that ultracold molecules will play a prominent role in the basic sciences and applications (such as sensors). While outstanding work in fundamental and applied science has come from ultracold atomic physics, a similar plunge by molecular physics into the ultracold arena will bring forth topics and applications that atoms cannot canvass: atoms are simple denizens of the quantum and physical-science worlds; molecules are entirely different, possessing internal degrees of freedom that can reach and explore phenomena untouchable by atoms.

The ideal substance for initial experiments would be many millions molecules crowded densely enough to interact (collide) with their neighbors and cooled to the point of neither vibrating nor rotating nor moving much at all (an absolute temperature of 1 millikelvin or less). From there, one can consider the molecules like slumped marionettes ready for animation by a skilled practitioner. It remains difficult, however, to produce such a starting point of absolute molecular calm, mainly because the degrees-of-freedom one would like to manipulate are not easily brought to rest in the first place. This report outlines our proposed approach to cooling and accumulating cold molecules, and summarizes our accomplishments in that endeavor. Our ultimate goals included demonstrating the laser-cooling of molecules and their subsequent storage in an accumulator. The novel principles and techniques brought forth by this research will enrich both atomic and molecular ultracold physics along with their realms of unique sensors.

The foregoing and the following sections associate motion with temperature. For present purposes, lower temperatures mean less agitation, usually slower speeds but more importantly more similarity among speeds. In a room (at 295 kelvin), the nitrogen in air can have speeds anywhere from several meters per second to

one-thousand meters per second. This is agitated traffic indeed, a scene of fast and frequent collisions. Were it cooled to 1 millikelvin, though, nitrogen would move about far less chaotically—much more uniformly—at an easy pace between a crawl and a brisk walk (a couple of meters per second).

Background and Research Objectives

With rare exception, current experiments and methods do not produce the desired dense ensemble of ultracold molecules in their lowest internal energy state and barely moving at a temperature of 1 millikelvin. One technique is termed “buffer-gas loading” and is akin to placing molecules into a special freezer. The exemplary case puffed molecules into a chamber filled with very cold helium (the buffer gas) and then suspended and concentrated them between two superconducting magnets [1]. The temperature of the trapped molecules got no lower than the 400 millikelvin of the buffer gas. Attempts at evacuating the buffer gas – the refrigerant – in order to proceed with experiments on the molecules in isolation were unsuccessful [2, 3]. Molecules (polar molecules, to be specific) can be slowed by a tube-like device called a Stark decelerator, a machine that applies a sequence of electric fields to molecules as they pass through. Most useful are Stark decelerators with a trap at the end to hold the slowed molecules. The temperatures of the trapped molecules, however, are usually high (200 millikelvin), and the density is so thin that molecules rarely encounter one another [4, 5]. Physicists from JILA with theorist colleagues assembled cold molecules from cold atoms. They brought this method to a technical apex by forming very cold diatomic molecules (KRb) from an equally cold mixture containing potassium and rubidium atoms [6]. The molecular density peaked at an exceptionally high value but lasted too briefly for subsequent experiments. A related technique of atomic assembly forms special and very cold molecules that are fundamentally intriguing [7]. However, these molecules are too slight, with weak bonds stretched over vague

distances, to consider them durable or suitable against the manipulations and studies one would like to undertake with regular molecules. Lastly, like earlier researchers that deflected atomic beams with lasers [8, 9] (even lamp light! [10]), researchers at Yale provided a harbinger for laser-cooling molecules in their laser-deflection of a molecular beam by a laser [11]. Their work incorporated and proved our earlier proposal for laser-cooling molecules [12], which we undertook in this LDRD program.

Our objectives were to laser-cool and trap a diatomic molecule (calcium monohydride, or CaH) that looks much like an atom when it comes to laser cooling. In some respects, the experiment recalls pivotal experiments of the early 1980's that showed how laser light when shined against an atomic beam can decelerate and cool the atoms to temperatures below 1 millikelvin [13]. Our calculated expectation for slowing and cooling a molecular beam of CaH is shown in Figure 1. Based on realistic conditions, the calculation showed that cooling real molecules to 0.1 millikelvin—a temperature significantly less than that attained by many others—appeared to be technically feasible. Following the laser-cooling process, the molecules would travel to an accumulator that, functionally, is like an accumulator of high-energy physics practice, where streams or bunches of particles can be amassed and stored. An accumulator is an essential device for gathering molecules into a dense cluster. To date, however, accumulators are unknown in atomic and molecular physics despite their possible utility in those fields. Our design and eventual demonstration of an accumulator we thus took to be an important and rare bridge between disciplines that are separated by a factor of more than one trillion in the energy of particles they use.

We built and proved a dual-purpose atomic/molecular beam machine (diagrammed in Figure 2), assembled the needed lasers, measured the machine's performance for the case of our test particle of lithium (our surrogate for the more complicated CaH), and designed an accumulator. Though well positioned by project's end to meet our objectives, we ultimately ran out of time in an endeavor that remains exceedingly difficult (and elusive) at the few institutions that attempt to laser-cool and trap molecules. Nevertheless, the devices and discoveries we made during our determined push for success will be useful to the physics and chemistry communities. For example, we were the first group, to our knowledge, to design and use (quite successfully) a fiber-coupled laser-ablation source for atomic/molecular beam experiments, a novel set-up that might also be useful in LIBS and other types of analytical-chemistry techniques. We also arrived at a design for an accumulator that is far simpler to make and use than what we originally envisioned. These and other accomplishments

are described in more detail in the next section.

Scientific Approach and Accomplishments

As mentioned earlier, our approach to laser cooling appears similar to the arrangements of the seminal experiments in laser-cooling atoms [13]. There is, however, an important distinction. Where a so-called effusive source (a hot, low-pressure oven with a small hole) suffices for directing atoms to a laser-cooling experiment, molecules must be delivered through an intense supersonic jet. The experimental setup is somewhat more complicated but gains two important advantages. First, a jet-source produces a beam with a velocity spread one-hundred times narrower than a comparable beam from an effusive source. The narrow velocity profile yields more molecules within the range of velocity that is susceptible to laser cooling. Second, the jet source performs the work of cooling the internal energy (the rotations and vibrations) of the molecules. When the jet ultimately rarifies and becomes a beam, one finds the molecules frozen into their lowest quantum states as well as moving at a fairly uniform speed. Effusive beams cannot produce this ideal beginning to laser-cooling molecules. Laser-cooling then takes over and dissipates the kinetic energy of these molecules without disturbing their internally-frozen state, to have them arrive at the entrance of the accumulator internally still and uniformly slow. All this occurs in several milliseconds.

A key to generating the entrained supersonic beam at room temperature is introducing the solid precursor material into an expanding carrier gas. We accomplish this with a laser vaporization source, as shown in Figure 3. In this source, a rotating, translating rod of Li (our surrogate for CaH) or CaH₂ (the precursor for CaH), is impinged upon with a high peak power laser pulse (0.25 to 1 gigawatts per square centimeter delivered in 10 nanoseconds) orthogonal to a pulsed valve evolving carrier gas bursts at 10 times per second. The pulsed valve sets the beam direction (Figure 1). As mentioned, we successfully designed and implemented a novel fiber optic delivery system for these necessary high-fluence laser pulses. The atoms or molecules of interest are born in a high-temperature plasma, but they quickly achieve characteristics, as described below, of the carrier through collisions with the dense gas. This source is the starting point for subsequent cooling and accumulation. We believe use of this source, or one similar to it, is novel to the laser cooling community in general and a necessary prerequisite to directly laser cooling molecules.

When we started the project, it was unknown whether the motion any particle (an atom or molecule) so laser-ablated would equilibrate to the cold temperatures of the expanding, transient bursts of carrier gas. And if the burst of gas

were too brief for even the carrier gas to reach its limiting cold temperature, what would come of the particles born from the hot, bright spark of a laser-produced plasma? Our concerns were dispelled by our careful measurements in the case of a xenon carrier gas. Lithium, it turned out, attained a translational temperature about half that of xenon's, a curious result nonetheless supported by a theory of dynamic "ultracooling" in supersonic expansions [14]. Figure 4 examines the velocity of lithium that we measured as it traveled through the diagnostics chamber (Figure 1). The circles are the measurements, and the curves are different velocity distributions associated with different temperatures. Recall that more uniformity in velocity means a lower temperature. While lithium travels at an average speed of 300 meters per second, the range of velocity is rather compressed and exhibits a temperature of 1 kelvin (the blue curve). We had expected, however, from standard theory, the velocity range to be broader and described by a temperature of 2.2 kelvin (the red curve). A supersonic jet thus works to our advantage in a third and unexpected way by delivering particles considerably "pre-cooled" to the laser-cooling phase. The production rate of laser-cooled molecules would consequently be higher. The result also further recommends the straightforward machine of a supersonic beam operated with room-temperature gases as a platform for generating laser-cooled molecules.

Our accumulators trap neutral atoms and molecules in the ground state. The ground-state energy levels of an atom are split into multiple levels by a magnetic field (Zeeman effect). If the energy of a particular Zeeman level increases with field, the force on the particle is in the direction of decreasing field. This is a field-repelled state. If the Zeeman energy decreases with field, the force is in the direction of increasing field and the state is field-seeking. Particular states can be selected by means of optical pumping with laser beams [15]. Various accumulator configurations were modeled by numerical integration of particle orbits. The first concept investigated was similar in concept to a storage ring for charged particles with charge-exchange injection, but with sextupole magnets replacing the quadrupole magnets of a charged-particle storage ring and laser transitions replacing the foil stripping used for injection into charged-particle storage rings. We found that if there were gaps between magnets (at least one gap is required for injection), orbits were unstable. The second concept investigated was a linear sextupole array with solenoids on the ends. Although trapped orbits were stable, the phase-space acceptance was too low. The third and best concept investigated was a cusp solenoid trap. Trapped orbits are stable and phase-space acceptance is good. The trap consists of two permanent-magnet solenoids in a cusp-

field configuration. Injection requires two state transitions (Figure 5). The injection concept allows continuous injection with increasing storage density until an equilibrium density is reached, with losses balancing the injection rate.

Papers on particle ultracooling by the supersonic jet, the fiber-coupled laser ablation source, and the accumulator are in various stages of preparation.

Impact on National Missions

Ultracold molecular matter is rife with research opportunities that will help us understand and control the quantum mechanics of reactions and collective phenomena, thus providing another window into the details of material behavior we wish to exploit or invent. The field will flourish once ultracold molecular matter can be produced regularly and reliably, an international goal we believe our research has put in much closer reach. The accumulator, while introduced here to gather molecules and atoms for basic studies, can be seen more generally as a new device brought by an interdisciplinary combination of high- and low-energy physics. A continued dialogue between these groups at the nexus of accumulators and particle-optics could lead to new constructs of matter-wave circuits as applied to the detection of external fields and gravity gradients.

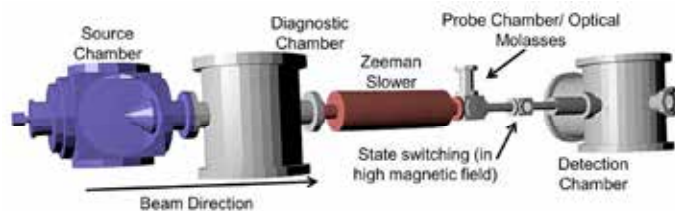

Figure 1. Diagram of our dual-purpose atomic/molecular beam machine. The beam propagates from left to right. Atoms and molecules are generated by a laser-ablation pulse in the source chamber, get entrained in a supersonic expansion of a "carrier" gas (such as argon or xenon), and become a sharp puff of gas soon after the source chamber. Experiments with Li atoms prove concepts for molecular species. Li will have similar terminal velocities (determined by carrier gas) from our source. For Li-cooling experiments, a Zeeman slower is included, which can be switched off allowing for the necessary length in cooling molecular species through laser-frequency-chirp cooling.

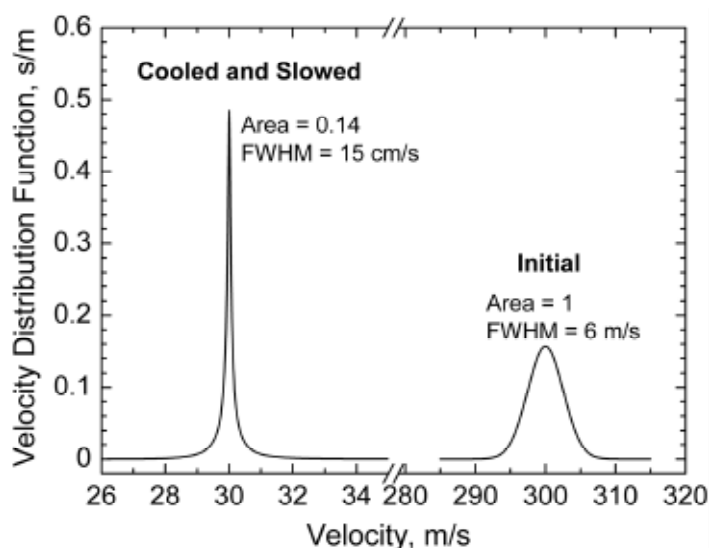

Figure 2. Expected compression and reduction of CaH axial velocity following laser cooling and slowing. After subjecting the molecules to laser cooling, the velocity slows from 300 meters per second to 30 meters per second. Also, the width of the velocity distribution gets compressed to 15 centimeters per second, which signifies a temperature of 0.1 millikelvin.

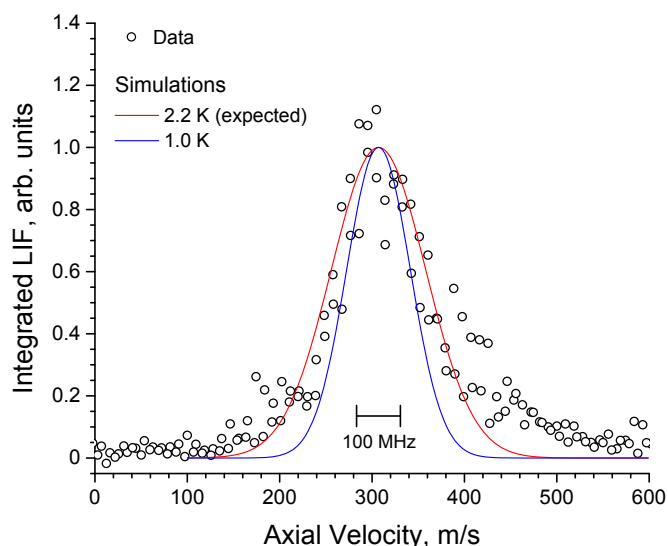

Figure 4. Measured velocity distribution (circles) of lithium atoms after being cooled by a supersonic expansion of xenon. A velocity distribution equivalent to 2.2 K was expected (red curve). The data instead matched the narrower distribution associated with a temperature 1.0 K (blue curve).

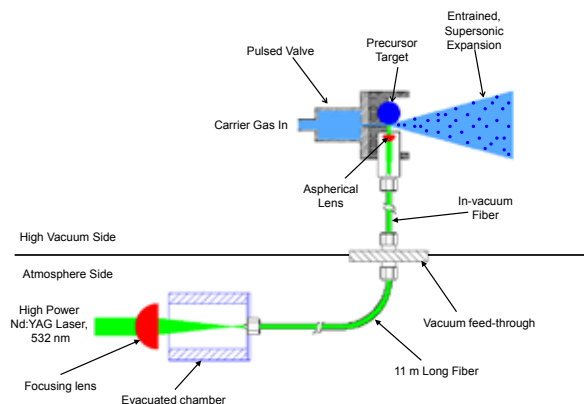

Figure 3. A representation of the fiber-coupled laser ablation source for generating species to be cooled and studied. A target rod of precursor material (Li or CaH) is impinged upon by a high peak power laser while rotating and translating. A novel fiber delivery system was designed and built to carry the laser light to the target. Some of the particles born in the hot plasma generated by the laser light are quickly assimilated and thermalized in the dense carrier gas plume. Because they adopt the characteristics of the colder, heavier carrier gas, this source serves as a necessary starting point for subsequent laser cooling and accumulation.

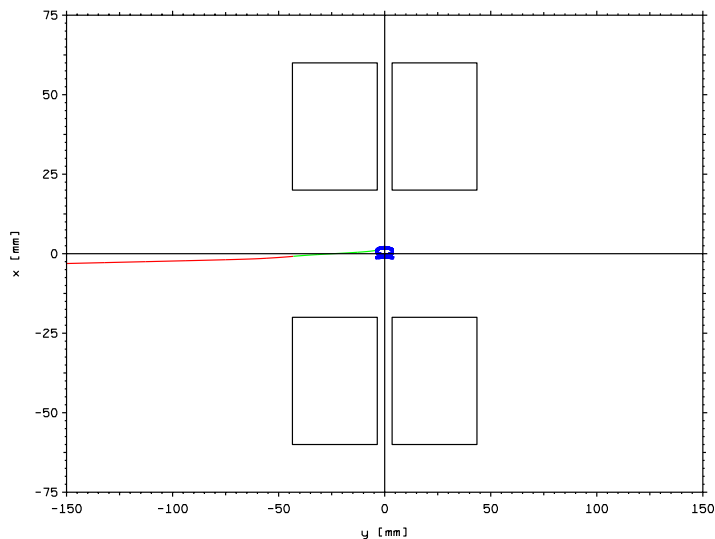

Figure 5. Orbit of an injected and subsequently trapped Li atom in the cusp-solenoid trap. The rectangles are the cross sections of the two ring-shaped permanent-magnet solenoids. The magnets are positioned on either side of the x-z plane, and a lithium atom approaches the trap from the left near the horizontal (y) axis. The trajectory is colored red where the atom is in the field-repelled state and heading toward the magnets. Close to the left magnet, a transition is made to the field-seeking state where the color changes from red to green. Near the gap between the ring magnets, a second transition returns the atom to the field-repelled state, indicated by the switch to the blue color. The loops of the blue-colored trajectory show the atom to be trapped near the field minimum in the center after this second transition.

References

1. Weinstein, J. D., R. deCarvalho, T. Guillet, B. Friedrich,

- and J. M. Doyle. Magnetic trapping of calcium monohydride molecules at millikelvin temperatures. 1998. *Nature*. 395: 148.
2. Campbell, W. C., E. Tsikata, H. I. Lu, L. D. van Buuren, and J. M. Doyle. Magnetic trapping and Zeeman relaxation of $\text{NH} (X \text{sup}\{3\}\Sigma \text{sup}\{-}\{1\})$. 2007. *Physical Review Letters*. 98: 213001.
 3. Campbell, W. C., T. V. Tscherbul, H. I. Lu, E. Tsikata, R. V. Krems, and J. M. Doyle. Mechanism of collisional spin relaxation in $\text{sup}\{3\}\Sigma$ molecules. 2009. *Physical Review Letters*. 102: 013003.
 4. Gilijamse, J. J., J. Küpper, S. Hoekstra, N. Vanhaecke, S. Y. T. van de Meerakker, and G. Meijer. Optimizing the Stark-decelerator beamline for the trapping of cold molecules using evolutionary strategies. 2006. *Physical Review A*. 73: 063410.
 5. Sawyer, B. C., B. K. Stuhl, D. Wang, M. Yeo, and J. Ye. Molecular beam collisions with a magnetically trapped target. 2008. *Physical Review Letter*. 101: 203203.
 6. Ni, K. K., S. Ospelkaus, M. H. G. de Miranda, A. Pe'er, B. Neyenhuis, J. J. Zirbel, S. Kotochigova, P. S. Julienne, D. S. Jin, and J. Ye. A high phase-space-density gas of polar Molecules. 2008. *Science*. 322: 231.
 7. Jochim, S., M. Bartenstein, A. Altmeyer, G. Hendl, S. Riedl, C. Chin, J. Hecker Denschlag, and R. Grimm. Bose-Einstein condensation of molecules. 2003. *Science*. 302: 2101.
 8. Ashkin, A.. Atomic-beam deflection by resonance-radiation pressure. 1972. *Physical Review Letters*. 25: 337.
 9. Schieder, R., H. Walther, and L. Wöste. Atomic beam deflection by the light of a tunable dye laser. 1972. *Optics Communications*. 5: 337.
 10. Frisch, R.. Experimenteller nachweis des Einsteinschen strahlungsrückstoßes (Experimental detection of the Einstein recoil radiation). 1933. *Zeitschrift für Physik*. 86: 42.
 11. Shuman, E. S., J. F. Barry, D. R. Glenn, and D. DeMille. Radiative force from optical cycling on a diatomic molecule. 2009. *Physical Review Letters*. 103: 223001.
 12. Rosa, M. D. Di. Laser-cooling molecules: Concept, candidates, and supporting hyperfine-resolved measurements of rotational lines in the A–X(0,0) band of CaH. 2004. *European Physical Journal D*. 31: 395.
 13. Phillips, W. D., and H. Metcalf. Laser deceleration of an atomic beam. 1982. *Physical Review Letters*. 48: 596.
 14. Miffre, A., M. Jacquy, M. Büchner, G. Tréneç, and J. Vigué. Parallel temperatures in supersonic beams: Ultracooling of light atoms seeded in a heavier carrier gas. 2005. *The Journal of Chemical Physics*. 122: 094308.
 15. Happer, W. H., and W. A. Wijngaarden. An optical pumping primer. 1987. *Hyperfine Interactions*. 38: 435.

Publications

Ferguson, S., P. Walstrom, J. Velasquez, III, and M. Di Rosa. Design of a magnetic trap and accumulator for laser-cooled atoms and molecules (LA-UR-13-25214). Presented at LANL Student Symposium. (Los Alamos, NM, 26-27 July 2013).

Velasquez, J., P. L. Walstrom, and M. D. Di Rosa. Developing density of laser-cooled neutral atoms and molecules in a linear magnetic trap. Presented at 2013 Meeting of the Division of Atomic, Molecular, and Optical Physics of the American Physical Society. (Quebec City, Quebec, Canada, 3-7 June 2013).

Velasquez, J., P. L. Walstrom, and M. D. Di Rosa. Laser Cooling Molecules. Presented at International Symposium on Molecular Spectroscopy. (Champaign-Urbana, 16-20 June, 2014).

Walstrom, P. L., and M. D. Di Rosa. Beam transport and storage with cold neutral atoms and molecules. 2012. In *International Particle Accelerator Conference 2012*. (New Orleans, 20-25 May 2012). , p. 1281. New York: IPAC'12 OC / IEEE.

Multiscale Spacecraft Charging Simulations in Support of New Space Missions

Gian L. Delzanno
20120190ER

Abstract

The ability to emit a high-power electron beam from a magnetospheric spacecraft has the potential to open up a new field of experimental space plasma physics and greatly enhance our understanding of the near Earth environment. However, it has never been realized because of potentially catastrophic spacecraft charging problems. Unlike the case of beam experiments in the ionosphere, the tenuous magnetospheric plasma cannot provide the return current necessary to keep the spacecraft charging under control and alternative pathways must therefore be sought. One such pathway is a concept where a high-density contactor plasma is emitted prior and after the electron beam to aid beam emission.

The goal of this project was to study the feasibility of using a plasma contactor to allow the emission of a high-power electron beam from a magnetospheric spacecraft. Two strategies were envisioned. In the first the contactor current is lower than the beam current and the contactor is used to collect background electrons over a much larger area than the spacecraft could cover alone. In the second the contactor current is larger than the beam current and the mitigation of spacecraft charging is achieved via ion emission. We have performed state-of-the-art simulations to compare the two strategies just outlined. Our conclusion is that the electron collection route is not viable since the contactor fails to draw a large current from the background. Ion emission, on the other hand, is viable: the contactor allows ion emission off its large, quasi-spherical cloud avoiding the space charge limits that normally prevent ion beam emission.

This project has been successful in providing the critical missing piece necessary for beam experiments to operate in the low-density magnetosphere via the contactor technology. It also helped strengthen and further develop important simulation capabilities that are now also used for other programs.

Background and Research Objectives

The idea of using a high-power electron beam with substantial current (of the order of 0.1 A) emitted by a spacecraft to probe the magnetic field configuration of the near Earth environment has been discussed since the seventies [1]. It would allow critical, fundamental understanding of how magnetic field topologies stretch in response to their drivers, and where the instabilities responsible for explosive energy transfer occur. These are two open, long standing questions of space physics. Unfortunately, the experimental realization of this idea onboard a magnetospheric spacecraft has never been accomplished because of catastrophic spacecraft charging problems.

Spacecraft charging is a common phenomenon in the Earth's magnetosphere (the region extending for hundreds of thousands of km around the Earth, where the Earth's magnetic field governs the dynamics of the plasma electrons and ions), where the spacecraft charges due to the collection of plasma particles from the surrounding plasma environment. Even at charge levels of approximately 10^{-7} Coulombs harmful electrostatic discharges on the spacecraft may occur, leading to electronic upsets and sometimes even to total spacecraft failure. Emitting an electron beam current from the spacecraft implies leaving a positive charge on the spacecraft. If the spacecraft cannot collect a current from the surrounding environment that balances the beam current, it charges to very high levels and creates an electric field that pulls the electron beam back. These considerations explain why spacecraft/electron-beam experiments have been successfully operated in the ionosphere (the region of the upper atmosphere extending from ~ 100 to 600 km) [2]. In the ionosphere, the plasma is sufficiently dense to provide a return current that can balance a ~ 0.1 A electron beam and spacecraft charging can be maintained at safe levels. Unfortunately, spacecraft charging problems become severe in the magnetosphere, where the plasma density is too small. To give some reference parameters,

at the geosynchronous orbit the thermal current from the background plasma is of the order of tens of micro-A, orders of magnitude lower than the ~ 0.1 A beam current. The spacecraft would charge to 9 MV and prevent beam emission. Indeed, spacecraft charging for electron beam experiments in the magnetosphere has been pointed out as an outstanding technical issue for space physics in the recent decadal survey of the field [3].

A few years ago, an international LANL-lead team put forward a new mission concept, called ConnEx, to probe the Earth's magnetic field configuration by means of a high-power electron beam emitted by a magnetospheric spacecraft [4]. The electron beam is used to trace magnetic field lines from the magnetosphere to the ionosphere, as can be seen in Figure 1. They proposed to use the plasma contactor technology to resolve the spacecraft charging problems discussed above. In essence, before firing the electron beam, the spacecraft emits a high density, neutral plasma (i.e. the contactor plasma). This creates a high-density plasma reservoir near the spacecraft that supplies the electron current needed to balance the beam current. Over time the contactor cloud loses its electrons to the spacecraft, leaving behind a positively charged contactor cloud that can be neutralized by collecting electrons from the surrounding environment. Therefore the contactor plasma can be seen as a way to collect background electrons over a much larger area than that given by the spacecraft alone and raise the background current from tens of micro-A to ~ 0.1 A without incurring any catastrophically large spacecraft potentials. The ConnEx team developed the mission concept but was unable to demonstrate that the contactor would mitigate spacecraft charging to safe levels. Hence, they were unable to proceed with a mid-size NASA Explorer mission proposal.

The goal of this project was to study the feasibility of using a plasma contactor to allow the emission of a high-power electron beam from a spacecraft far out in the magnetosphere, and to provide the critical missing piece for the ConnEx mission proposal to go forward.

Scientific Approach and Accomplishments

The technical approach was based on Particle-In-Cell (PIC) simulations to study spacecraft charging driven by electron beam emission in different settings that included or not the presence of the contactor plasma and/or the background magnetospheric plasma. The simulations of the full system are very challenging, since the contactor plasma has very high density and its characteristic scales are much smaller than those of the background plasma. We have employed a newly developed, state-of-the-art code for PIC simulations on curvilinear grids called CPIC that was

further improved during the development of this project. Theoretical analysis was used whenever possible in connection with the simulation work.

Our most important accomplishments are the following.

Capability development

Relative to its competitors in the spacecraft charging area, CPIC provides a unique simulation capability in the following ways: 1) its formulation is independent of the geometry of the problem (i.e. any geometry can be easily implemented); 2) it uses body-fitted structured meshes to capture complex geometry while maintaining efficient memory access patterns (versus the unstructured meshes used by competitors) and 3) does not need tracking algorithms to localize the particles on the mesh alleviating significant computational overhead. Hence, the last two points result in lower algorithmic complexity and better performance of the code. During this project, we further improved CPIC in several critical ways. First, the solver used to obtain the electric field from the plasma particles now leverages the Black Box Multigrid (BoxMG) solver library. Multigrid is the only solver that scales optimally with the problem size (i.e., the mesh resolution) for the kind of problems targeted in this project. Moreover, the BoxMG technology is unique in that it delivers this scaling, and corresponding performance gain, on body-fitted meshes. Second, the code has been extended from two to three spatial dimensions. In addition, CPIC is equipped with algorithms for particle motion that in certain geometries or model configurations capture faster time scales analytically, leading to significantly larger time steps (i.e. faster run time) without compromising the accuracy of the simulation. Finally, the code has been parallelized using the domain decomposition technique and now runs efficiently on hundreds of cores of machines available through the LANL institutional high performance computing program (e.g., Mapache). CPIC has been verified against a number of standard tests and known theories. References [5,6] describe some of the development work on CPIC. With the improvements achieved through this project, CPIC has matured into a powerful research tool that can be used to address the challenges of multiscale plasma physics, and is particularly suited for studies of the interaction of plasmas with materials.

Failure of the electron collection strategy for beam experiments in the magnetosphere

We have performed a simulation campaign to investigate spacecraft charging under conditions relevant to ConnEx. After injecting the contactor plasma for some time in order to achieve contactor clouds of progressively larger volumes, we have studied two cases where a) the contactor injection is turned off while beam emission is turned on, and b) the contactor injection is kept on (with ion contac-

tor current lower than the beam current) while beam emission is turned on. In the first case, after an initial transient that is mitigated by the size of the contactor cloud (as expected, the larger the contactor cloud, the lower the rise of the spacecraft potential) the spacecraft accumulates a strong positive charge and pushes the ion contactor cloud away. At this point contact between the spacecraft and the ion contactor cloud is lost and the spacecraft returns to a situation similar to the case when the contactor is absent and incurs catastrophic spacecraft charging problems. In the second case, contact between the spacecraft and the ion cloud is maintained but the contactor is unable to draw a neutralizing current from the background. Thus, for the cases considered the electron beam could not be emitted. This work identifies the inability of the contactor to draw a large current from the magnetospheric background as the weak link of an electron collection strategy for beam experiments in the magnetosphere and the root cause of the failure of this approach. Figure 2 shows the time evolution of the spacecraft potential for some cases from the simulation campaign a). These findings are presented in Ref. [7].

Identification of an alternative route for beam experiments in the magnetosphere

One can envision an alternative strategy where the electron beam current is balanced by emitting an equal ion current. However, emitting a $\sim 0.1A$ ion beam is not viable because ion emission is strongly space charge limited. This means that as soon as the ions are emitted from the spacecraft, strong electric fields develop and most of the ions return to the spacecraft, letting only a tiny ion current escape. By performing an extensive simulation campaign where both the electron beam and contactor were operated simultaneously in a regime where the ion contactor current is larger than the beam current [labeled as c)], we have discovered that the contactor can be used as an ion emitter. Basically the contactor emits ions off its large, quasi-spherical, outer surface. When this surface is sufficiently large, space charge effects no longer limit ion emission. In this way the contactor controls and mitigates the peak of the spacecraft potential, and a sufficiently large contactor cloud keeps spacecraft charging to safe levels that allow beam emission. Figure 3 shows the time evolution of the spacecraft potential for some cases obtained during simulation campaign c): compared with Figure 2, one can see the mitigation of the transient of the spacecraft potential induced by the contactor. These findings are presented in Reference [8].

In addition to the main accomplishments discussed above, a success not originally planned was the discovery that the most widely used theory of charging for a spherical object in a plasma can break down in the limit when the object

is positively charged [9]. This result can have a remarkable impact in magnetic fusion energy applications and is currently one of the focus of a proposal that an experimental collaborator (Prof. Svetlana Ratynskaia) has submitted to the European Union, in which we are external collaborators. Furthermore, a new and more general model for the steady state configuration of the expanded plasma plume has been developed [10].

In concert with the computational and theoretical work, this project also reached out to the community by co-organizing a series of presentations on Scientific Magnetic Mapping and Techniques at biannual meetings sponsored by the National Science Foundation's Geospace Environment Modeling program in space physics. Over the last three years, this series of presentations included approximately 100 short talks, papers, and invited talks. These presentations are archived at the website, bit.ly/gem_mapping, and review papers are planned. This activity, at the premier conference on the topic of magnetospheric modeling, has served to raise the awareness of the many facets of this challenging problem, as well as its strategic importance.

Impact on National Missions

This project has been successful in several ways. First of all, it created a significant experimental and programmatic opportunity by establishing a fundamentally new path forward for performing beam experiments in the magnetosphere. This new approach was the critical missing piece that prevented LANL to go forward with a NASA mission explorer proposal (in the \$200-500M range) a few years ago. We are in close contact with Reiner Friedel (NASA point of contact at LANL), Eric Dors (program manager for the Global Security Emerging Threats office at LANL) and Herb Funsten (chief scientist in the Intelligence and Space Research division at LANL) to capitalize on these results and be ready for the next NASA mission explorer proposal call (expected within the next year or so). The next step that we will try to pursue is the experimental validation of the results obtained by this project, and we plan to continue providing modeling support in this phase. Second, the capabilities that were developed in part during this project are now playing a major role in other programs, like the DOE Fusion Energy Sciences program where CPIC is being used to understand the transport of dust impurities in a magnetic fusion energy reactor. Finally, our improved capabilities have helped us promote new collaborations with groups outside LANL (like Prof. Svetlana Ratynskaia's group at the Royal Institute of Technology in Sweden in the area of modeling and experiments of dust transport in plasmas), increasing the visibility and impact of our program.

References

1. Kivelson, M. G., and C. T. Russell. Active experiments, magnetospheric modification, and a naturally occurring analogue. 1973. *Radio Science*. 8 (11): 1035.
 2. Winckler, J. R.. Controlled Experiments in the Earth's Magnetosphere with Artificial Electron Beams. 1992. *Rev. Modern Phys.*. 64 (3): 859.
 3. Solar and Space Physics: A science for a Technological Society. 2012. National Research Council, National Academies Press. : 1.
 4. Borovsky, J. E., D. J. McComas, M. F. Thomsen, J. L. Burch, J. Cravens, C. J. Pollock, T. E. Moore, and S. B. Mende. Magnetosphere-Ionosphere Observatory (MIO): A multisatellite mission designed to solve the problem of what generates auroral arcs. 2000. *Eos Trans. Amer. Geophys. Union*. 79 (45): F744.
 5. Delzanno, G. L., E. Camporeale, J. D. Moulton, J. E. Borovsky, E. A. MacDonald, and M. F. Thomsen. CPIC: A Curvilinear Particle-in-Cell Code for Plasma-Material Interaction Studies. 2013. *IEEE Transactions on Plasma Science*. 41 (12): 3577.
 6. Delzanno, G. L., and E. Camporeale. On particle movers in cylindrical geometry for Particle-In-Cell applications. 2013. *Journal of Computational Physics*. 253: 259.
 7. Delzanno, G. L., J. E. Borovsky, M. F. Thomsen, and J. D. Moulton. Beam experiments in the magnetosphere with plasma contractors: the electron collection and ion emission routes. *Journal of Geophysical Research*.
 8. Delzanno, G. L., J. E. Borovsky, M. F. Thomsen, J. D. Moulton, and E. A. MacDonald. Beam experiments in the magnetosphere: how do we get the charge off the spacecraft?. *Journal of Geophysical Research*.
 9. Delzanno, G. L., and X. Z. Tang. Charging and Heat Collection by a Positively Charged Dust Grain in a Plasma. 2014. *Physical Review Letters*. 113: 035002.
 10. Camporeale, E., E. A. Hogan, and E. A. MacDonald. Approximate semi-analytical solutions for the steady-state expansion of a contactor plasma. To appear in *Plasma Source Science Technology*.
- for plasma-material interaction studies. Presented at American Physical Society April meeting (International Sherwood Fusion theory conference. (Atlanta, GA, 31 Mar - 3 Apr 2012).
- Camporeale, E., E. A. Hogan, and E. A. MacDonald. Approximate semi-analytical solutions for the steady-state expansion of a contactor plasma. To appear in *Plasma Sources Science and Technology*.
- Camporeale, E., G. L. Delzanno, J. E. Borovsky, E. A. MacDonald, and M. F. Thomsen. The expansion of plasma in a transverse magnetic field. Presented at 2013 International Sherwood Fusion Theory Conference. (Santa Fe, NM, 15-17 April 2013).
- Camporeale, E., G. L. Delzanno, J. E. Borovsky, E. A. MacDonald, and M. F. Thomsen. The expansion of a plasma in a transverse magnetic field. Presented at 40th European Physical Society Conference on Plasma Physics. (Aalto, Finland, 1-5 Jul 2013).
- Delzanno, G. L., E. Camporeale, E. Hogan, J. D. Moulton, J. E. Borovsky, E. A. MacDonald, and M. F. Thomsen. Probing the Earth's magnetosphere with an electron gun. Presented at 55th Annual Meeting of the APS Division of Plasma Physics . (Denver, CO, 11-15).
- Delzanno, G. L., E. Camporeale, J. D. Moulton, J. E. Borovsky, E. A. MacDonald, and M. F. Thomsen. CPIC: a curvilinear Particle-In-Cell code for plasma-material interaction studies. Presented at American Geophysical Union fall meeting. (San Francisco, CA, 3-7 Dec 2012).
- Delzanno, G. L., E. Camporeale, J. D. Moulton, J. E. Borovsky, E. A. MacDonald, and M. F. Thomsen. CPIC: a curvilinear Particle-In-Cell code for spacecraft-plasma interaction studies. Invited presentation at 12th Spacecraft Charging and Technology conference. (Kitakyushu, Japan, 14-18 May 2012).
- Delzanno, G. L., E. Camporeale, J. D. Moulton, J. E. Borovsky, E. A. MacDonald, and M. F. Thomsen. CPIC: a curvilinear Particle-In-Cell codes for dusty plasma studies. Invited presentation at 13th Workshop on the Physics of Dusty Plasma. (Waco, TX, 20-23 May).
- Delzanno, G. L., E. Camporeale, J. D. Moulton, J. E. Borovsky, E. A. MacDonald, and M. F. Thomsen. CPIC: a curvilinear Particle-In-Cell code for plasma-material interaction studies. Presented at American Physical Society Division of Plasma Physics meeting. (Providence, RI, 29 Oct -2 Nov 2012).
- Delzanno, G. L., E. Camporeale, J. D. Moulton, J. E. Borovsky, E. A. MacDonald, and M. F. Thomsen. CPIC: a Curvilinear Particle-In-Cell code for plasma-material interaction studies. 2013. *IEEE Transactions on Plasma Science*. 41 (12): 3577.

Publications

Boella, E., M. Giraud, and G. L. Delzanno. Numerical investigation of the oscillations in a virtual cathode. Presented at 40th European Physical Society Conference on Plasma Physics. (Aalto, Finland, 1-5 Jul 2013).

Camporeale, E.. CPIC: a curvilinear Particle-In-Cell code

- Delzanno, G. L., E. Camporeale, J. E. Borovsky, E. A. MacDonald, M. F. Thomsen, and E. A. Hogan. Probing the Earth's magnetosphere with an electron gun. Presented at 40th European Physical Society Conference on Plasma Physics. (Aalto, Finland, 1-5 Jul 2013).
- Delzanno, G. L., E. Camporeale, J. E. Borovsky, E. A. MacDonald, M. F. Thomsen, and S. Markidis. Instabilities during the expansion of a plasma in a transverse magnetic field. Presented at AGU Fall meeting. (San Francisco, CA, 9-13 Dec 2013).
- Delzanno, G. L., E. Camporeale, and J. D. Moulton. Adaptive Particle-In-Cell methods. Invited presentation at 40th European Physical Society Conference on Plasma Physics. (Aalto, Finland, 1-5 Jul 2013).
- Delzanno, G. L., J. E. Borovsky, M. F. Thomsen, J. D. Moulton, and E. A. MacDonald. Beam experiments in the magnetosphere: how do we get the charge off the spacecraft?. *Journal of Geophysical Research*.
- Delzanno, G. L., J. E. Borovsky, M. F. Thomsen, J. D. Moulton, and E. A. MacDonald. Beam experiments in space: how do we take the charge off the spacecraft?. Presented at AGU Fall Meeting. (San Francisco, CA, 15-19 Dec 2014).
- Delzanno, G. L., J. E. Borovsky, M. F. Thomsen, and J. D. Moulton. Beam experiments in the magnetosphere with plasma contactors: the electron collection and ion emission routes. *Journal of Geophysical Research*.
- Delzanno, G. L., and E. Camporeale. On particle movers in cylindrical geometry for Particle-In-Cell simulations. 2013. *Journal of Computational Physics*. 253: 259.
- Delzanno, G. L., and X. Tang. Charging and Heat Collection by a Positively Charged Dust Grain in a Plasma. 2014. *Phys. Rev. Lett.* 113: 035002.
- Delzanno, G. L., and X. Z. Tang. Breakdown of the Orbital-Motion-Limited charging theory in the positively charged regime. Presented at 56th Annual Meeting of the APS Division of Plasma Physics. (New Orleans, LA, 27-31 Oct 2014).
- Giraud, M., G. L. Delzanno, and E. Camporeale. Theoretical and computational studies of the sheath of a planar, electron emitting wall. Presented at American Physical Society Division of Plasma Physics. (Providence, RI, 29 Oct - 2 Nov 2012).
- Hogan, E. A., G. L. Delzanno, E. Camporeale, J. E. Borovsky, E. A. MacDonald, and M. F. Thomsen. Modeling the expansion of a contactor plasma. Presented at American Geophysical Union fall meeting. (San Francisco, CA, 3-7 Dec 2012).
- Hogan, E. A., G. L. Delzanno, E. Camporeale, J. E. Borovsky, E. A. MacDonald, and M. F. Thomsen. Modeling the expansion of a contactor plasma. Presented at American Physical Society Division of Plasma Physics meeting. (Providence, RI, 29 Oct- 2 Nov 2012).
- Markidis, S., G. Lapenta, G. L. Delzanno, P. Henry, M. V. Goldman, D. L. Newman, T. Intrator, and E. Laure. Signatures of collisionless magnetic reconnection driven by kink instability of a flux rope. 2014. *Plasma Physics and Controlled Fusion*. 56 (6): 064010.
- Moulton, J. D., G. L. Delzanno, and J. E. Dendy. Exploring parallelization and performance of a Particle-In-Cell method. Invited presentation at 13th Copper Mountain Conference on Iterative Methods. (Copper Mountain, CO, 6-11 Apr 2014).
- Zhao, L., and G. L. Delzanno. Charging and shielding of a non-spherical object in a plasma. Presented at 55th Annual Meeting of the APS Division of Plasma Physics. (Denver, CO, 11-15 Nov 2013).
- Zhao, L., and G. L. Delzanno. Charging and shielding of a non-spherical dust grain in a plasma. Presented at AGU Fall meeting. (San Francisco, CA, 9-13 Dec 2013).

From Waste to Fuels and Feedstocks: Reduction of CO₂ Using Main-Group Catalysts

Andrew Sutton
20120197ER

Abstract

The staggering amount of carbon dioxide (CO₂) produced annually has global ramifications and creates technical restrictions that dictate the viability of potential solutions. As a result, any practical proposal for CO₂ remediation must minimize economic cost by requiring low energy input and using abundant materials. While sequestration has been proposed as a solution to this problem, an alternative that off-sets the costs involved in remediation is to take a cue from Nature and convert CO₂ into value-added products as is done in photosynthesis. As CO₂ is the most abundant C₁ feedstock on the planet, a mild route for its conversion into methanol (MeOH) would prove to be valuable. The importance of MeOH in this regard is that, as a precursor to a multitude of products (including formaldehyde, dimethyl ether, transesterified biodiesel, and even gasoline), the chance of oversupply is low. The work outlined in this proposal approaches this goal in a 3-step manner defined by (1) the binding and activation of CO₂, (2) reduction of the activated complex by a hydrogen gas (H₂) carrier, and (3) release of MeOH and water followed by coordination of another equivalent of CO₂. The fundamental platform we will use for this chemistry is based around the concept of frustrated Lewis pairs (FLPs), which arise when an electron pair donor (Lewis base) and an electron pair acceptor (Lewis acid) are precluded from forming a stable adduct by the size of their respective supporting substituents. This unquenched (i.e. "frustrated") Lewis acid/base combination exhibits interesting reactivity, including small molecule activation and metal-free catalysis.

In the process of task 1, we will synthesize a library of FLPs with systematic variations in the character and electronic nature of the components. The interaction of these FLPs with CO₂ will then be characterized in order to support task 2. Various Lewis-pair H₂ carriers (such as ammonia borane) will then be investigated for their ability to convert bound CO₂ into MeOH and for their

resilience to the reaction conditions. The final step, task 3, will be to turn the system catalytic by regeneration of the H₂ carrier and recovery of the intact FLP. Our work in this area will involve evaluating the transferability of ammonia borane regeneration to other dehydrogenated main group materials along with the development of carriers that activate H₂ directly. The ultimate goal of this project is to construct a system comprised of two separate FLPs, one that cleaves H₂ and one that binds CO₂. When this FLP combination is fed an input mixture of CO₂/H₂, the reduction of CO₂ to MeOH in one pot will occur without requiring any external regeneration of the components. Such a system based on main group materials could be implementable on a worldwide scale and would position LANL for further funding opportunities in co-development with H₂ generation from catalyzed photolytic water splitting. Combined, the culmination of these two areas would move us closer to creating a synthetic analogue of photosynthesis in support of domestic energy security.

Background and Research Objectives

The large-scale release of CO₂ into the atmosphere has become an issue of worldwide attention due to its deleterious environmental effects. The issue is further exacerbated by the rapid growth and industrialization of developing countries. However, Nature, in the form of photosynthesis, has shown us that the solution is not to treat CO₂ as waste (conventional sequestration), but to utilize it as a C₁ feedstock for organic compounds. Many known synthetic systems for reducing CO₂ are based around expensive and non-abundant metals. These are not practical on a global scale, and current industrial methods require high pressures and temperatures which are energy intensive and therefore expensive. Frustrated Lewis pairs (FLPs), based on abundant main-group elements, have been shown to exhibit interesting catalytic activity. However, the use of FLPs for CO₂ conversion is currently beset with problems such as recycling of the H₂ carrier and stability of the FLP.

CO₂ is a relatively inert polarized molecule with linear geometry consisting of a sp-hybridized carbon coordinated to two oxygen atoms with short (1.16 Å) C=O double bonds. While hydrogenation to form MeOH and H₂O is thermodynamically favorable (ΔH^0 -131 kJ/mol, ΔG^0 -9 kJ/mol), the activation barrier is prohibitive without a catalyst. CO₂ can form complexes in three main modes: (1) η^1 -coordination through carbon to an electron rich atom (a Lewis base), (2) η^1 -coordination by oxygen to an electron deficient atom (a Lewis acid), and (3) in an η^2 -fashion as a π -complex to an atom with both donor and acceptor properties.

Frustrated Lewis pairs (FLPs) are systems containing both a Lewis acid (electron pair acceptor) and a Lewis base (electron pair donor) which are prevented from forming a stable adduct due to the steric requirements of the substituents. The result is a molecule that has unusual and interesting reactivity resulting from the unquenched Lewis acidity and basicity. A simple example was first described by Brown et al. in 1942 in which lutidine and BF₃ formed an adduct while no adduct was observed when BMe₃ was substituted for BF₃.

The FLP tBu₃P/B(C₆F₅)₃ is known to react with CO₂ at room temperature by binding both the carbon and one oxygen of CO₂. When heated to 70 °C, this molecule releases CO₂ and the FLP can be recovered. CO₂ can also be reversibly bound by the ethyl linked FLP (C₆H₂Me₃)₂P-C₂H₄-B(C₆H₅)₃, although the release of CO₂ occurs at -20 °C.

A more recent example uses an 2AlX₃/P(C₆H₃Me₃)₃ (X = Cl, Br) system to give a rare example of double activation of CO₂ in which two Al-O bonds are formed. Ammonia borane (AB) can then be used as a H₂ transfer reagent to reduce the bound CO₂ to a methoxide group at room temperature. While this is a promising route for the conversion of CO₂ to MeOH, there is a significant barrier to turning this process catalytic. However, it nonetheless provides a proof-of-concept conversion of CO₂ to MeOH using a FLP system. The two primary barriers that prevent this system from being catalytically useful stem from the sacrifice of the Lewis acid (irreversible formation of Al-O bonds) and the generation of products that are incompatible with the H₂ carrier. In the case of AB, we have observed in our prior research that acidic conditions will catalyze the dehydrogenation of AB relatively rapidly. Protic solvents can also facilitate dehydrogenation, leading to B(OR)₃ (R = H, alkyl) species which are difficult to regenerate to AB because of the thermodynamic stability of the B-O bond.

We note in passing that FLPs have been developed that activate other small molecules. In particular, H₂ can be heterolytically cleaved to yield a hydride (H⁻) on the Lewis

acid and a proton (H⁺) on the Lewis base. This separated hydrogen molecule can readily recombine, demonstrating the reversibility of this process. This observation has led to the use of FLPs in metal-free catalytic hydrogenation reactions of various substrates including imines, aziridines, enamines and silylenolethers. FLPs have also been used to activate other small molecules such as tetrahydrofuran (THF), isocyanates, aldehydes, alkenes, alkynes, and CO₂. We also note that AB itself has separated hydrides and protons akin to FLP activated H₂.

Scientific Approach and Accomplishments

Our proposed method for addressing the catalytic reduction of CO₂ by FLP systems can be broken down into three subtasks: (1) bind and activate CO₂, (2) reduce (hydrogenate) the bound CO₂, and (3) release the products and recover the catalyst and H₂ transfer agent. The activation of CO₂ by FLPs has been demonstrated, so efforts in task 1 will concentrate on creating a library of FLP adducts that we can use to methodically tune the electronic and steric effects to best enable the subsequent steps. Through various spectroscopic techniques such as infrared (IR) spectroscopy and nuclear magnetic resonance (NMR), we will be able to describe the electronic structure of these systems and quantify the degree of C=O bond activation. Initial efforts in task 2 will utilize AB to demonstrate reactivity, but in consideration of task 3 we will then move to phosphine-borane systems. A significant portion of our efforts in this area will concentrate on the mechanistic aspects of reduction in order to identify important reaction steps and intermediates which will provide a rational basis for system modification. Task 3 will be accomplished using FLP systems that do not undergo decomposition or other irreversible reactions in the presence of H₂O and MeOH. Based on the generality of our AB regeneration scheme, this route should be transferable to the regeneration of the phosphine-boranes we use in task 2. Ultimately, we will work towards the development of a double FLP-based system that can generate MeOH from a CO₂/H₂ input stream.

In our research efforts on the use of AB as a H₂ carrier, we have extensively studied the properties of this material, which is itself a Lewis acid/base system (i.e. a non-frustrated Lewis pair). One of the significant results to arise from this work is the ability to regenerate AB from multiple dehydrogenation products in a clean manner using hydrazine as the reductant in a cycle that only consumes a modest amount of H₂ with all other components being recycled. Note that in its role as a H₂ carrier, AB can either release H₂ itself as a gas, or it can serve as an “H₂” transfer agent by directly delivering reducing equivalents to a substrate as in Figure 4 (vide supra).

The nature of a FLP can be varied by changing the donor and/or acceptor, according to the electronic influence of the supporting substituents and the size of those substituents. This modular system enables us to tune the reactivity of individual components. Specifically, we propose to explore N-B, N-Al, P-B, and P-Al pairs using organic supports on N and P. The substituents on the Lewis acid will include halides, alkyl, aryl and alkyl- and aryl-oxides. This modularity will be used to systematically vary our FLPs in order to engineer a system that is resistant to the resultant alcohol and to the reaction medium.

The coordination and activation of CO₂ will be accomplished by creating a library of Lewis pairs and exposing them to CO₂ under a variety of pressures and temperatures. We will also investigate the effect of adding additional equivalents of the Lewis acid to coordinate both CO₂ oxygen atoms as this may be a key component of enhanced CO₂ activation. Infrared (IR) spectroscopy will be a rapid and effective technique in determining CO₂ ligation due to the large change in C-O stretching frequency that will occur upon activation or binding. The pairs that activate CO₂ will then be characterized in terms of their thermal stability and susceptibility to CO₂ loss. A range of spectroscopic techniques will enable us to extensively characterize these compounds. Nuclear magnetic resonance (NMR) will be the primary method of characterization as most of the nuclei pertinent to this study are readily observable via this technique (³¹P, ¹³C, ¹¹B, ²⁷Al and ¹H). However, in addition to the shifts in electron density quantified through NMR, DFT calculations and isotopic substitution IR spectroscopy (i.e. use of ¹³C and ¹⁸O-labeled CO₂) will provide additional data on the nature of these species. Finally, where feasible, single crystal X-ray crystallography will be used to verify spectroscopically assigned structures. These experiments will give insight into the localization of the electrons and elucidate the nature and extent of activation. The thermodynamic parameters of reduction will be probed using electrochemistry and spectroelectrochemistry, which will give valuable guidance on choosing the right H₂ carrier for the multi-electron reduction process. Although there are examples of CO₂ ligation by FLPs, this systematic experimentation on FLP activation of CO₂ has not been attempted previously. We expect that this area will present technical challenges, but none beyond the normal challenges in exploratory synthetic chemistry.

The second aspect of our proposed work is the reduction of activated CO₂ with a H₂ carrier. It has been shown both theoretically and experimentally that AB is an effective H₂ transfer agent. We will use AB in the initial stages of evaluating the reduction of various FLP-bound CO₂ spe-

cies. We already know that AB itself will not be well suited for the goals of Task 3 (releasing product and recovering catalyst and H₂ transfer agent). The technical reason is that AB readily reacts with MeOH and H₂O to form B-O bonds which cause its regeneration to be energetically expensive. Nonetheless, in initial reduction experiments we will use AB owing to its favorable dehydrogenation thermodynamics and that it will provide useful information on the behavior of our FLP-CO₂ systems under stoichiometric conditions. It is expected that the majority of the experimental and theoretical work in this area of the project will involve mechanistic studies to determine the reaction pathway and whether it involves concerted or step-wise addition of H equivalents. The experimental mechanistic studies will make use of anticipated intermediates such as formaldehyde and formic acid in order to elucidate their interaction with the FLPs that we study. The primary technical challenge in this area will be the identification of H₂ carriers that do not decompose under the reaction conditions. It has been observed by us and reported by others that phosphine-borane adducts exhibit increased stability compared to amine-borane adducts. We will seek to exploit this decreased sensitivity and examine these as possible H₂ carriers by experiment and thermodynamic calculations. We will also use FLP systems known to cleave H₂, and our overall strategy for this will be discussed further in the following section.

The final aspect of this work will be to develop conditions where all components are recovered and a true catalytic process can operate. Based on the generality of the AB regeneration process we have developed (*vide supra*) and its believed mechanism, we expect that this route can be applied to regenerate dehydrogenated phosphine-borane materials. Based on the thermodynamic stability of P-B over N-B, we do not believe that the use of NH₃ as a solvent will pose any significant challenge. However, the use of any H₂ carrier that requires external regeneration increases the complexity and expense of the cycle. Our goal in this area is to use a H₂ carrier that interacts with H₂ directly and can be regenerated directly from H₂ gas. In this regime, the input stream would simply contain H₂ and CO₂. Our approach to this will be a double FLP system (i.e. two separate FLPs) as FLPs that react with H₂ more strongly than CO₂ are known. We will use the results from our CO₂ activation and mechanistic studies as a guide to likely FLP combinations, and then perform competition experiments monitored via NMR to determine relative binding affinities. A potential challenge in this approach will be cross-interaction between FLP constituents, but it is expected that there will be an equilibrium mixture rather than deactivation due to the nature of the FLP bond. A second potential challenge is that there may be no FLP

combination which reacts with CO₂ preferentially over H₂. However, the insertion of CO₂ into a FLP-H₂ complex and its subsequent reduction has been demonstrated, albeit in a non-regenerable fashion or using a sacrificial reductant. So, it is possible that a single FLP may in fact react with both CO₂ and H₂ directly to form MeOH and we intend to fully explore this possibility.

A variety of FLPs have been shown to bind CO₂, but relatively few FLPs support the conversion of CO₂ into useful reduction products such as MeOH or CH₄. In particular, Stephan et al. reported that PMes₃/AlCl₃ and PMes₃/AlBr₃ systems react with CO₂ and ammonia borane (NH₃BH₃) to form MeOH upon quenching with water. While this reaction proceeds under ambient conditions, the aluminium-oxygen bonds formed during quenching preclude catalytic reactivity. The pathway for this reaction is not clear, with computational results arguing a step-wise mechanism, while further experimental results support the possibility of a more complicated mechanism involving dissociation of components from the PR₃(CO₂)(AlX₃)₂ adduct. More recently, using the concept of enhancing FLP reactivity through geometric constraint (preorganization) demonstrated in CO₂ binding, A vicinal P-B molecule that could catalyze the formation of methoxyborates from CO₂ and various borane-based reducing agents was reported. As with PMes₃/AlX₃, MeOH is released upon quenching with H₂O, albeit with the formation of boric acid (a thermodynamic sink).

One of the limiting factors in this chemistry is the oxophilicity of B and Al. Not only does this cause an issue with concomitant H₂O formation during CO₂ conversion to MeOH (assuming hydrogenation as the model), but it also necessitates high temperatures if thermal extrusion of MeOH is attempted. Our hypothesis at the outset of this work was that the use of B- and Al-esters could protect the catalyst from this interaction and the H₂O-sensitivity of this class of complexes. While complexes of the type A(OR)₃ (A = B, Al, R = Me, iPr, tBu, Ph) are available commercially, they do not exhibit reactivity with CO₂ when paired with PCy₃ or PPh₃. This negative result is likely because of the decreased Lewis acidity of these acids relative to acids such as B(C₆F₅)₃, AlCl₃, and AlBr₃ which do bind CO₂.

Al(OC₆F₅)₃ (F-5) is a dimeric complex in the solid state ([Al(OC₆F₅)₃]₂) that can be synthesized by addition of AlEt₃ to a toluene solution of HOC₆F₅. Similar reaction conditions using HOC₆Cl₅ and HOC₆H₂Cl₃ can be used to synthesize [Al(OC₆Cl₅)₃]₂ ((Cl-5)₂) and [Al(OC₆H₂Cl₃)₃]₂ ((Cl-3)₂) respectively. (Cl-5)₂ is insoluble in toluene, and so crashes out of solution as a white solid during synthesis. In contrast, (Cl₃)₂ is slightly soluble in toluene and can

thus be crystallized if necessary (Figure 1). While we did not obtain a solid-state structure of (Cl-5)₂, based upon (F-5)₂ and (Cl-3)₂ as well as others such as [Al(OtBu)₃]₂, [Al(O-2,6-Me₂Ph)₃]₂, and [Al(OCH(CF₃)₂)₃]₂, it is reasonable to believe that it too adopts a dimeric structure. This would also be consistent with its insolubility.

Comparing the metrical parameters of (F-5)₂ and (Cl-3)₂ we see the same approximately tetrahedral arrangement of O atoms around each Al atom with a pinched internal O-Al-O angle and an expanded external O-Al-O angle. While there is an initial suggestion of correlation between the Al-O and Al-Al distances and Lewis acidity given the expected Lewis Acidity of F-5 and Cl-3, the parameters of other dimeric complexes such as [Al(O-2,6-Me₂Ph)₃]₂ argue against this.

Addition of PPh₃ to (Cl-3)₂ allowed for the isolation of (PPh₃)Cl-3 from toluene and its structural determination (Figure 2). The Al-P bond length is 2.438(4) Å. To the best of our knowledge PPh₃ adducts of aryl Al esters of this type have not been previously structurally characterized, and thus we cannot draw upon direct structural comparisons. However, a few reference PPh₃-Al adducts are available in the Cambridge Structural Database. The Al-P bond lengths in (PPh₃)AlEt₃ and (PPh₃)AlMe₃ are 2.5413(4) Å and 2.5329 Å respectively. For (PPh₃)AlCl₃ and (PPh₃)Al(OC(CF₃)₃)₃, this distance is 2.4296(15) Å and 2.445 Å. The longest Al-P bond length in the alkyl aluminium complexes is consistent with the concept that they are the most electron rich and thus least Lewis acidic. It is also reasonable that PPh₃-AlCl₃ would show a shorter Al-P distance. The observation of an increased Al-P distance within (PPh₃)Al(OC(CF₃)₃)₃ could be due more favourable hydrogen bonding interactions. Attempts to quantify the Lewis Acidity trend via the ³¹P NMR shift of OPet₃ were ambiguous due lack of clear 1:1 OPet₃-AlOR₃ adduct formation.

DFT (B3LYP/DZVP2) and G3MP2 calculations on the bond dissociation free energies of AlX₃/PR₃ (X = H, F, Cl, Br, CH₃; R = H, CH₃) adducts are not consistent with a clear trend along the halogens (consistent with the varied rankings available in the literature), but it is clear that more electron-rich phosphines bind more tightly (PH₃ vs. PMe₃) and that more electron-rich alanes bind more loosely (AlH₃ vs. AlMe₃ vs. AlX₃, X = F, Cl, Br).

Similar to PPh₃-Al(OC(CF₃)₃)₃, we did not observe splitting of H₂ with PPh₃-F-5, but the PPh₃ adduct did bind CO₂. However, these early experiments displayed indications of aryl C-H activation and so further work was conducted using PCy₃ despite the expected higher binding energy (more electron-rich phosphane). PCy₃-Cl-3 shows slow

C-H activation of CH₂Cl₂, with appearance of [HPCy₃]⁺ in the ³¹P NMR spectrum.

Testing for CO₂ reactivity was accomplished by exposing a degassed solution or mixture of PCy₃ and Lewis acid to ca. 1 atm. of ¹³CO₂ and then examining the ¹³C{¹H} and ³¹P{¹H} NMR spectra. In contrast to Al(OiPr)₃, Al(OtBu)₃, and Al(OPh)₃, F-5, Cl-3, and Cl-5 all bind CO₂ with diagnostic ³¹P-¹³C coupling (Figure 3).

The Al systems structurally characterized by Stephen et al. show that there is a 2:1:1 Al:CO₂:P ratio. In contrast, reports of known B-based Lewis acid FLP-CO₂ complexes predominantly have a 1:1:1 B:CO₂:P ratio. This difference likely arises from the decreased Lewis acidity and oxophilicity of B relative to Al. This would also be consistent with known pre-organized P-Al complexes lacking electron-withdrawing groups binding CO₂ with only one Al. While we were unable to obtain a solid-state structure of a CO₂ adduct, the solution ¹³C{¹H} and ³¹P{¹H} NMR spectra of our Al-ester-CO₂ adducts are consistent with a mixture consisting of mostly the 1:1:1 complex when ¹³CO₂ is added to a 1:2 PCy₃:Cl-3 mixture. It would be expected that the CO₂ C atom would have less electron density when two Lewis acids are coordinated to the CO₂ moiety rather than one of the same. This is consistent with the observed shift in the NMR spectra where the C atom is effectively deshielded. Taking this view, this Al ester is more akin to Lewis acids such as B(C₆F₅)₃ than AlX₃ in terms of FLP reactivity. As the aryl substituent is adjusted going to Cl-5 and then F5, this balance changes and the mixture becomes more biased towards bis coordination (Figure 5). This is a trend that tracks with what one may predict based on trends in substituent electron-withdrawing ability. The stronger the Lewis acid, the greater the average number of acids per CO₂.

Regardless of the ratio, addition of NH₃BH₃ to PCy₃/CO₂/Al(OR)₃ (F-5, Cl-5, Cl-3) systems resulted in complete conversion of PCy₃ to [HPCy₃]⁺ as determined by ³¹P{¹H} and ³¹P NMR spectra. ¹³C{¹H} NMR spectra show a methoxy group (presumably coordinated to Al(OR)₃) along with formate in the case of F-5 and Cl-3. Addition of H₂O to these mixtures releases MeOH, but results in the decomposition of the Al esters.

Aluminum esters derived from halogenated aromatic alcohols were synthesized and tested as Lewis acids for the FLP-mediated reduction of CO₂. While F-5, Cl-5, and Cl-3 were competent in this regard when paired with PCy₃, the reaction could not be made catalytic due to the need to quench the resulting complex with H₂O in order to release MeOH. Stoichiometric quantities would not likely decompose these esters immediately, the FLP would still need

to be regenerated from the resulting H₂O adduct. These results reinforce the need to develop systems that can release MeOH under mild thermolysis rather than depend on falling further down a thermodynamic sink through the formation of Al (and B) oxides and hydroxides; a limitation that even catalytic FLP-mediated CO₂ reduction to MeOH suffers.

Impact on National Missions

Due to concern over CO₂ as a greenhouse gas, the DOE has taken steps to develop the conversion of CO₂ to value-added products such as fuels and feedstocks. In order to do this effectively on a large scale, cost and material availability must be considered. Moving away from precious metals to main-group elements as catalysts has enabled us to develop a catalytic system for CO₂ reduction which would not only be relatively cost-efficient, but also support the DOE & LANL Grand Challenges.

The DOE has recently been making major efforts to develop research on the conversion of CO₂ into useful feedstocks and fuels. To this end, it is essential that LANL becomes an innovative leader in this area of basic energy science. Investments in low-cost (i.e. non-precious metal) catalytic routes to reduce CO₂ are also a key component in developing a secure domestic energy portfolio. With a wealth of experience in main-group chemistry and building upon the Lewis acid/base chemistry already developed with ammonia borane, Andrew Sutton and Nathan Smythe have strived to develop non-metal based catalytic systems for the reduction of CO₂ to methanol and additional substrates of important synthetic utility. This will help develop the current synthetic capabilities for clean, sustainable energy technologies currently at LANL and will not only mitigate the environmental effects of CO₂, but it will also help reduce our Nation's dependence on foreign energy sources. The proposed work supports the Energy and Earth Systems grand challenge, which is expected to remain a core LANL mission in the years to come.

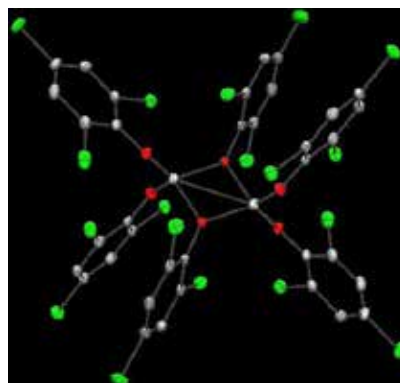

Figure 1. X-Ray crystal structure of (I) with hydrogen atoms and toluene omitted, 50% thermal ellipsoids.



Figure 2. X-Ray crystal structure of PPh⁻ with hydrogen atoms omitted and 50% thermal ellipsoids.

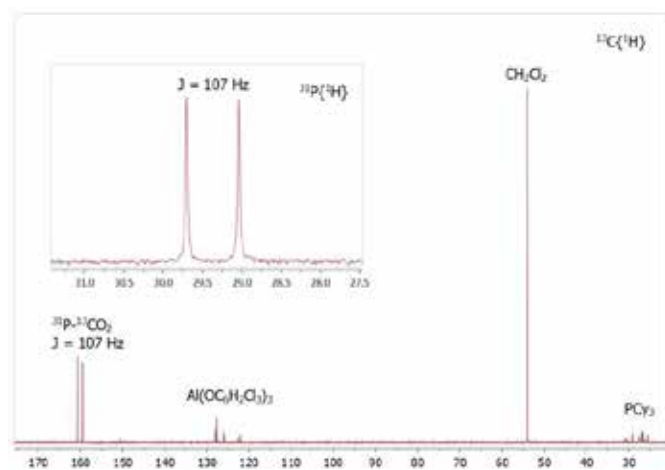

Figure 3. $^{13}\text{C}\{^1\text{H}\}$ and $^{31}\text{P}\{^1\text{H}\}$ NMR spectra (inset) of CO addition to a 1:1 mixture of PCy:Al(OCHCl) in CHCl₃ showing P-C coupling.

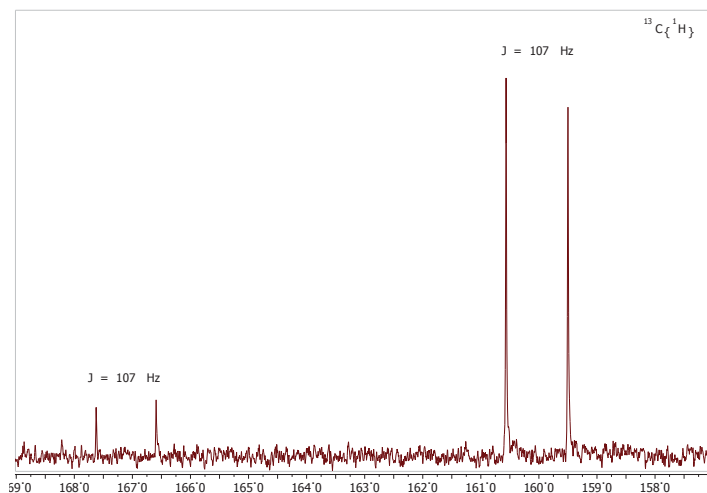

Figure 4. $^{13}\text{C}\{^1\text{H}_3\}$ and $^{31}\text{P}\{^1\text{H}\}$ NMR spectra (inset) of CO addition to a 1:1 mixture of PCy:Al(OCHCl) in CHCl₃ showing P-C coupling.

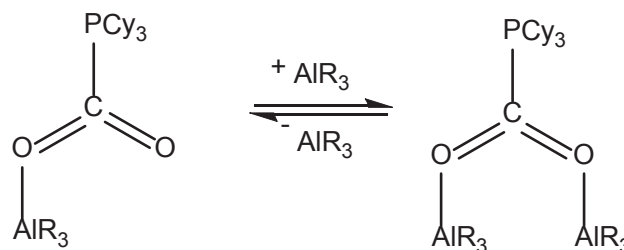

Figure 5. Interconversion of mono- and bis-acid complexes. AIR = (est. 5-9%), (est. ca. 1:1), and (est. 23-26%).

References

1. Aresta, M., and A. Dibenedetto. Utilisation of CO₂ as a chemical feedstock: opportunities and challenges. 2007. Dalton Trans. Dalton Trans.. (28): 2975.

Publications

- Mendez, M., A. D. Sutton, N. C. Smythe, and D. A. Dixon. Interconversion of mono- and bis-acid complexes. AIR₃ = Cl-3 (est. 5-9% bis), Cl-5 (est. ca. 1:1 bis:mono), and F-5 (est. 23-26% mono). Journal of Physical Chemistry A.
- Mendez, M., N. C. Smythe, A. D. Sutton, and D. A. Dixon. Interconversion of mono- and bis-acid complexes. AIR₃ = Cl-3 (est. 5-9% bis), Cl-5 (est. ca. 1:1 bis:mono), and F-5 (est. 23-26% mono). Journal of Physical Chemistry A.
- Smythe, N. C., D. A. Dixon, E. B. Garner, M. Rickard, B. L. Scott, B. Zelenay, and A. D. Sutton. Interconversion of mono- and bis-acid complexes. AIR₃ = Cl-3 (est. 5-9% bis), Cl-5 (est. ca. 1:1 bis:mono), and F-5 (est. 23-26% mono). Chemical Communications.
- Zelenay, B., N. C. Smythe, and A. D. Sutton. Interconversion of mono- and bis-acid complexes. AIR₃ = Cl-3 (est. 5-9% bis), Cl-5 (est. ca. 1:1 bis:mono), and F-5 (est. 23-26% mono). Polyhedron.

Laboratory Study of Cosmically-Relevant Collisionless Shocks

Scott C. Hsu
20120200ER

Abstract

This project aimed to produce and study collisionless shocks in a laboratory plasma experiment. Although collisionless plasma shocks were first proposed in the 1950's and observed via space satellites in the earth's magnetosphere in the 1960's, much remains unknown about the shock formation mechanisms, structure, and particle energization dynamics, on which laboratory experiments could shed light and provide valuable data for benchmarking state-of-the-art numerical simulations. This project was successful in adapting an existing laboratory and upgrading and fielding new diagnostics to carry out successful plasma shock studies, although whether we successfully produced collisionless shocks is still an outstanding question subject to further analysis of large datasets collected toward the end of this project. Major published results include (1) the detailed characterization of supersonic plasma jets that were used in generating plasma shocks, (2) generation and detailed characterization of collisional plasma shocks, and (3) observation of a unique regime in which merging plasmas initially undergo collisionless interpenetration followed by a transition to collisional stagnation. A fourth result being written up for publication is the detailed observation of magnetic Rayleigh-Taylor instability growth and evolution, a result which was unplanned but appeared in our experiments fortuitously.

Background and Research Objectives

Collisionless shocks play an important role in energy transport and the evolution of particle distribution functions in space and astrophysical environments. However, many research questions relating to the microscopic physics of collisionless shock formation, evolution, and shock acceleration of particles to very high energies still remain unanswered. Although laboratory studies of collisionless shocks have been conducted since the 1960's, a recent renaissance of laboratory collisionless shock studies stems from the recognition (and resulting excitement) that modern laboratory plasmas can

satisfy key physics criteria for the shocks to have "cosmic relevance." This project aimed to establish a new and unique experimental platform for creating/studying collisionless shocks and shock-particle interactions with cosmic relevance. We used the head-on collision of two high velocity plasma jets formed/launched by plasma railguns to generate/study plasma shocks across collisionality regimes. Compared to other modern experiments, the proposed experiments have: (1) larger shock spatial size (up to 30 cm wide and a few cm thick) and longer shock time duration (several μs), allowing for detailed diagnosis and characterization of shock structure, evolution, downstream plasma parameters, and shock-particle interactions; and (2) independent application of magnetic field via coils that can be oriented either parallel or perpendicular to the direction of shock propagation. Obtaining physical insights into and experimental data on the scaling of collisionless shock structure, evolution, and their effects on particle dynamics were the primary objectives of the proposed work.

Scientific Approach and Accomplishments

We studied the merging of two railgun-driven supersonic plasma jets in two different geometries: oblique and head-on merging. The oblique merging was deliberately performed in a more collisional regime in order to form and study collisional plasma shocks, important to have a baseline but also of relevance to the application of plasma-jet-driven magneto-inertial fusion [1]. Experiments were conducted on the Plasma Liner Experiment (PLX), which was built under the sponsorship of the DOE Office of Fusion Energy Sciences.

We first studied and documented the parameters and evolution of a single propagating plasma jet [2], both to benchmark numerical simulations [3] of our plasma jets and merging experiments and to build confidence in our knowledge of the jet parameters upon merging. The latter is critical for establishing whether the jet interaction is collisional or collisionless.

Next, we studied oblique jet merging in a collisional regime (Figure 1), where we observed a very interesting multi-layer emission structure in the stagnation layer that formed between the merging jets. Through detailed analysis of the fast-framing images (Figure 1) in coordination with multi-chord interferometer and visible spectroscopy, and in comparison with shock theory and multi-fluid plasma simulations, we were able to establish that these observations are consistent with collisional oblique plasma shocks [4,5]. These observations constitute quite possibly the most detailed laboratory characterization of a collisional plasma shock in the published literature.

Following the oblique merging studies, we re-arranged our plasma jets into head-on merging geometry, which allowed us to access more collisionless regimes by nature of the lower density due to longer jet propagation distance (and expansion) before merging, and the gain in relative velocity due to elimination of the oblique merging angle. These experiments led to a set of very interesting results (Figure 2). Again, through careful analysis of interferometer and spectroscopy data and comparisons with plasma collisionality theory, we were able to establish that, at early time in the interaction, the plasma jets interpenetrated in a collisionless manner but then transitioned to collisional stagnation due to a dynamically rising mean-charge state Z [6]. The latter arose due to frictional heating of the electrons in one jet by the directed ions of the opposing jet. The counterstreaming ion collisionality depends on Z , and thus even a small rise in Z led to a very quick transition from a collisionless to collisional interaction. Because we used argon plasma jets, and had a sizable impurity population, the equation-of-state (EOS) was complex, i.e., the ionization state as a function of local density and temperature was not easily predictable. Thus, our dataset offers a unique opportunity to validate state-of-the-art plasma physics models of collisionality in the presence of complex EOS. In fact, collaborator Tech-X, which sells a commercial radiation-magnetohydrodynamics (MHD) code USIM, has asked to use our data for validation of their code in a DOE proposal they are writing.

Upon completion of these initial head-on merging experiments, we installed an in-chamber Helmholtz coil to introduce a magnetic field to the head-on jet-interaction region and performed a series of scoping experiments to get to even lower density and higher velocity for magnetized collisionless shock generation. During these scoping experiments with the Helmholtz applied magnetic field, we encountered a result for which we had not planned: a trailing portion of a plasma jet decelerated against the stagnated plasma that formed initially from the head-on merging of the leading portions of each jet. The decelerat-

ing plasma interface clearly showed the growth and evolution of Rayleigh-Taylor (RT) instability “fingers” (Figure 3). Furthermore, the RT fingers progressed toward longer wavelength, possibly due to a combination of magnetic stabilization and viscous damping. This multi-frame data of RT-instability evolution is completely unique and can be used to validate a multitude of ASC codes used for stockpile stewardship. University of New Mexico graduate student Colin Adams, who worked full-time on PLX for his Ph.D. dissertation research, is writing up this result for publication.

Our final experimental campaign, conducted over the final two months of this three-year project, focused on the highest velocity and lowest-density experiments we could perform while still being able to detect useful diagnostic signals. Data analysis is still ongoing to see whether we were able to successfully generate a collisionless magnetized plasma shock. The difficulty in generating a collisionless plasma shock was higher than expected due to the level of impurities present in our railguns. The impurities led to $Z > 1$, even in experiments using injected hydrogen,

Impact on National Missions

This work supports HEDPF (High-energy-density plasmas and fluids) strategy of the NPF (Nuclear and Particle Futures) Pillar by advancing plasma physics, plasma astrophysics, and experimental capability. It also supports the Lab’s energy security mission through the connection of this work to a potential low-cost development path to fusion energy (both through Office of Science and ARPA-E programs).

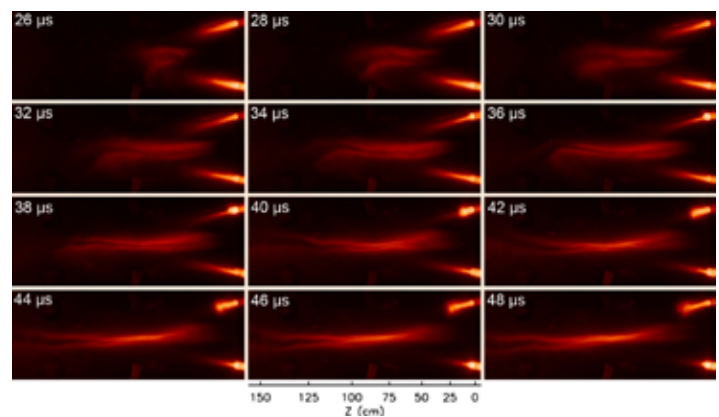

Figure 1. Fast-framing camera images of oblique merging of two supersonic plasma jets in a collisional regime.

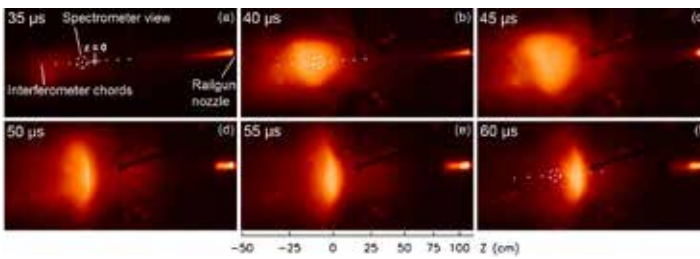

Figure 2. Fast-framing camera images of head-on supersonic jet merging in an initially collisionless regime (a) that then transitions to collisional stagnation and collisional shock formation (d-f).

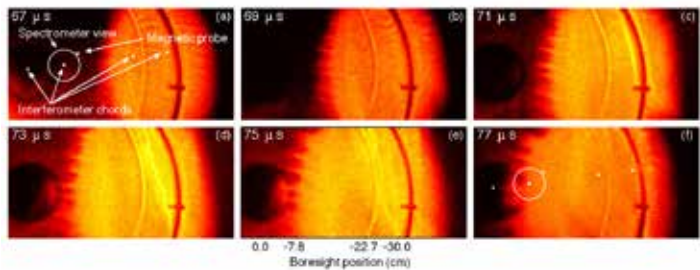

Figure 3. Fast-framing camera images of Rayleigh-Taylor instability evolution at a decelerating plasma interface.

References

- Hsu, S. C., T. J. Awe, S. Brockington, A. Case, J. T. Cassibry, G. Kagan, S. J. Messer, M. Stanic, X. Tang, D. R. Welch, and F. D. Witherspoon. Spherically Imploding Plasma Liners as a Standoff Driver for Magnetoinertial Fusion. 2012. IEEE Transactions on Plasma Science. 40 (5): 1287.
- Hsu, S. C., E. C. Merritt, A. L. Moser, T. J. Awe, S. J. E. Brockington, J. S. Davis, C. S. Adams, A. Case, J. T. Cassibry, J. P. Dunn, M. A. Gilmore, A. G. Lynn, S. J. Messer, and F. D. Witherspoon. Experimental characterization of railgun-driven supersonic plasma jets motivated by high energy density physics applications. 2012. Physics of Plasmas. 19: 123514.
- Thoma, C.. Particle-in-cell simulations of collisionless shock formation via head-on merging of two laboratory supersonic plasma jets. 2013. Physics of Plasmas. 20: 082128.
- Merritt, E. C., A. L. Moser, S. C. Hsu, J. Loverich, and M. Gilmore. Experimental characterization of the stagnation layer between two obliquely merging supersonic plasma jets. 2013. Physical Review Letters. 111: 085003.
- Merritt, E. C., A. L. Moser, S. C. Hsu, C. S. Adams, J. P. Dunn, A. M. Holgado, and M. A. Gilmore. Experimental evidence for collisional shock formation via two

obliquely merging supersonic plasma jets. 2014. Physics of Plasmas. 21: 055703.

- Moser, A. L., and S. C. Hsu. Observation of ionization-mediated transition from collisionless interpenetration to collisional stagnation during merging of two supersonic plasmas. To appear in Physics of Plasmas.

Publications

Hsu, S. C., A. L. Moser, E. C. Merritt, C. S. Adams, J. P. Dunn, S. Brockington, A. Case, M. Gilmore, A. G. Lynn, S. J. Messer, and F. D. Witherspoon. Laboratory plasma physics experiments using merging supersonic plasma jets.

Hsu, S. C., E. C. Merritt, A. L. Moser, T. J. Awe, S. J. E. Brockington, J. S. Davis, C. S. Adams, Case, J. T. Cassibry, J. P. Dunn, M. A. Gilmore, A. G. Lynn, S. J. Messer, and F. D. Witherspoon. Experimental characterization of railgun-driven supersonic plasma jets motivated by high energy density physics applications. 2012. PHYSICS OF PLASMAS. 19 (12).

Merritt, E. C., A. L. Moser, S. C. Hsu, C. S. Adams, J. P. Dunn, A. M. Holgado, and M. A. Gilmore. Experimental evidence for collisional shock formation via two obliquely merging supersonic plasma jets. 2014. PHYSICS OF PLASMAS. 21 (5).

Merritt, E. C., A. L. Moser, S. C. Hsu, J. Loverich, and M. Gilmore. Experimental Characterization of the Stagnation Layer between Two Obliquely Merging Supersonic Plasma Jets. 2013. PHYSICAL REVIEW LETTERS. 111 (8): -.

Moser, A. L., and S. C. Hsu. Observation of ionization-mediated transition from collisionless interpenetration to collisional stagnation during merging of two supersonic plasmas. To appear in Physics of Plasmas.

Thoma, C., D. R. Welch, and S. C. Hsu. Particle-in-cell simulations of collisionless shock formation via head-on merging of two laboratory supersonic plasma jets. 2013. PHYSICS OF PLASMAS. 20 (8): -.

Separation of Time Scales at High Latitudes: Fundamental Science and Numerical Method Development

Robert E. Ecke
20120206ER

Abstract

Understanding and characterizing oceans and atmospheres is very challenging owing to the vast range of spatial and temporal scales and the highly nonlinear nature of fluid flows. Rotation and stratification heavily influence these geophysical flows, leading to further challenges in their simulation, even with the fastest modern supercomputers. Further, many systems of equations that govern science important to the DOE exhibit similar properties; this LDRD project has had impacts on both the particular rotating/stratified problem and on the general algorithmic approach to a broad class of physics problems. This project has advanced the field in the at least three directions. First, we developed a new understanding of the separation of slow and fast time scales in rotating and stratified fluids and provided new diagnostics and a new way of viewing three (rather than two) time-scale interactions. We also developed new understanding, through laboratory experiments, of the nature of the structures of heat transport in rotating flow. Finally, we developed a novel method for numerically computing a 'locally slow' solution for systems of equations that exhibit scale separation including, for example, important problems in plasma physics and magnetohydrodynamics. This approach leads to a highly efficient parallel-in-time algorithm that could enable a far higher degree of parallelism for exascale computing than previously possible. The general nature of the algorithm is supported by theorems that bound the convergence rate for all systems of equations that exhibit this phenomenon. The algorithm has been tested for rotating and stratified flows with promising results and is already the topic of active research for climate and Tokamak simulations.

Background and Research Objectives

The ocean and atmosphere exhibit an enormous dynamical range in temporal scales, which makes the analysis and numerical simulation of such systems challenging. Charney [1] derived the first tractable model for weather

prediction by filtering out the fast (acoustic and gravity) waves. The neglected fast waves, however, feedback into the slow wave dynamics and can have physical significance, and using such reduced systems can lead to incorrect physics. Unfortunately, the large range of temporal scales in the ocean and atmosphere imposes unreasonably small time numerical constraints and represents a fundamental barrier to higher fidelity simulations.

A major goal of this LDRD is to understand the effect of this slow/fast wave interaction, and, in particular, the manner in which the fast waves transfer energy into the large-scale, slow wave dynamics. To accomplish this goal, a decomposition into regimes of behavior dominated by rotation, stratification, or both is essential and provides a basis for exploring these interesting regimes of parameter space. A portion of this work also uses laboratory experiments to investigate the structures that participate in heat transport. A second goal is the development of time-stepping methods that take advantage of the slow behavior in order to capture the full dynamics without sacrificing either important physical effects or with the speed of using less accurate reduced models.

Scientific Approach and Accomplishments

Motivated by these questions, this LDRD project has three parts: 1) a new theoretical framework for understanding the interaction between slow and fast waves (see [2] and [3]) and the nature of structures in different limits, and 2) a new parallel-in-time numerical integrator that utilizes the slow asymptotic structure to yield orders of magnitude speedup (see [4] and [5]), and 3) new experiments that explore the role of localized structures, e.g., tornados, in the transport of heat and momentum in rapidly rotating fluid flows.

We analyzed the effect of non-slow (typically fast) components of a rotating, stratified Boussinesq flow on the dynamics of the slow part (manifold) [1]. To do so, a decomposition that isolates the part of the flow living

on the slow manifold is used to investigate three distinct asymptotic limits (with corresponding reduced equations): rapid rotation, strong stratification, and simultaneously strong stratification and rapid rotation (quasi-geostrophy). Numerical simulations are also performed for each of these limits. The numerical experiments indicate that for the geometry considered (triplly periodic) and the type of forcing applied, the fluctuations act as a conduit, moving energy onto the slow manifold. This decomposition also clarifies how the energy is exchanged when either the stratification or the rotation is weak. In the quasi-geostrophic limit most of the energy transfer is between slow potential energy and slow kinetic energy, but the energetics owing to fluctuations are less clear. It is also observed that in each case the energy on the slow manifold equilibrates to a quasi-steady value. In addition, we extended this analysis to the case of three separated time scales [3].

We developed a new time-stepping method to integrate nonlinear PDEs that exhibit scale separation in time of a highly oscillatory nature [3] called Asymptotic-Parallel-in-Time. The algorithm combines the parareal method - a parallel-in-time scheme - with on-the-fly temporal homogenization, which makes use of the locally slow asymptotic structure of the equations. It is demonstrated in [3] that orders of magnitude parallel speedup are obtained relative to exponential integrators and Strang splitting (both of which solve the stiff oscillatory part exactly and therefore serve as a stringent comparison). To make this algorithm practical for general domains and spatial discretizations, a new (independent) time-parallel method for applying the operator exponential was also developed [4]. Principal advantages of this new method include: stability even for large time-steps, the ability to parallelize in time over many characteristic wavelengths, and large speed-ups over existing methods.

In order to go beyond the mathematical ideas of the theory and carefully examine the physics, we also devised an experiment to measure the structure and dynamics of fluid flow structures that form because of strong rotation in a weakly stratified environment. Such a system is rotating convection in the so-called “geostrophic” regime [6] where heat is transported locally via thin vertical structures with high internal vertical velocity, a mini tornado if you will. Outside of these localized structures, the flow is in geostrophic balance where pressure differences balance the effects of rotation. We have demonstrated the vertical coherence of these structures using particle-tracking techniques to obtain the local velocity field. We find that rotation greatly enhances the vertical coherence of thermal structures. By simultaneously measuring the temperature, we can compute the local heat transport in a

structure and construct the probability of strong localized transport via these thermal structures. Finally, we have measured the lateral separation of structures and varied the forcing of buoyancy and rotation to determine the dependence of the structure characteristics on the balance of those forcings. In Figure 1 we show a time-lapse image of the flow of one of these structures in which the lateral inflow and vertical up flow is visible in the particle streaks. Although not visualized well in this image, the flow is circulating around the centerline of the up flow in a rotating sense (as in a tornado). These measurements are giving us confidence that the typical phenomena observed in the reduced equations for strong rotation are also observed in related physical systems.

Impact on National Missions

This project has contributed to the fundamental underpinnings of climate modeling for which the influences of rotation and stratification are critically important. Through the discovery of a new slow/fast framework and novel computational algorithms, our results are beginning to influence other research groups to expand on our advances. We have been asked to speak about our results in numerous high profile venues around the world, significant indication of the impact our project is having. Because the world is poised to move from petascale computing to exascale computing, the discovery of the Asymptotic Parallel-In-Time method, along with the new linear propagator, has had an international impact. Nationally this work is a part of the DOE Exa-Math Report from the DOE Advanced Scientific Computing Research workshop in 2013, where it is called out as an important new idea to achieve exascale computing for climate and weather prediction, magnetohydrodynamics, plasma physics, and many other applications of interest to the DOE. The generality of the approach suggests that this novel algorithm will impact many DOE programs from energy production in magnetic fusion to understanding and predicting climate change impacts.

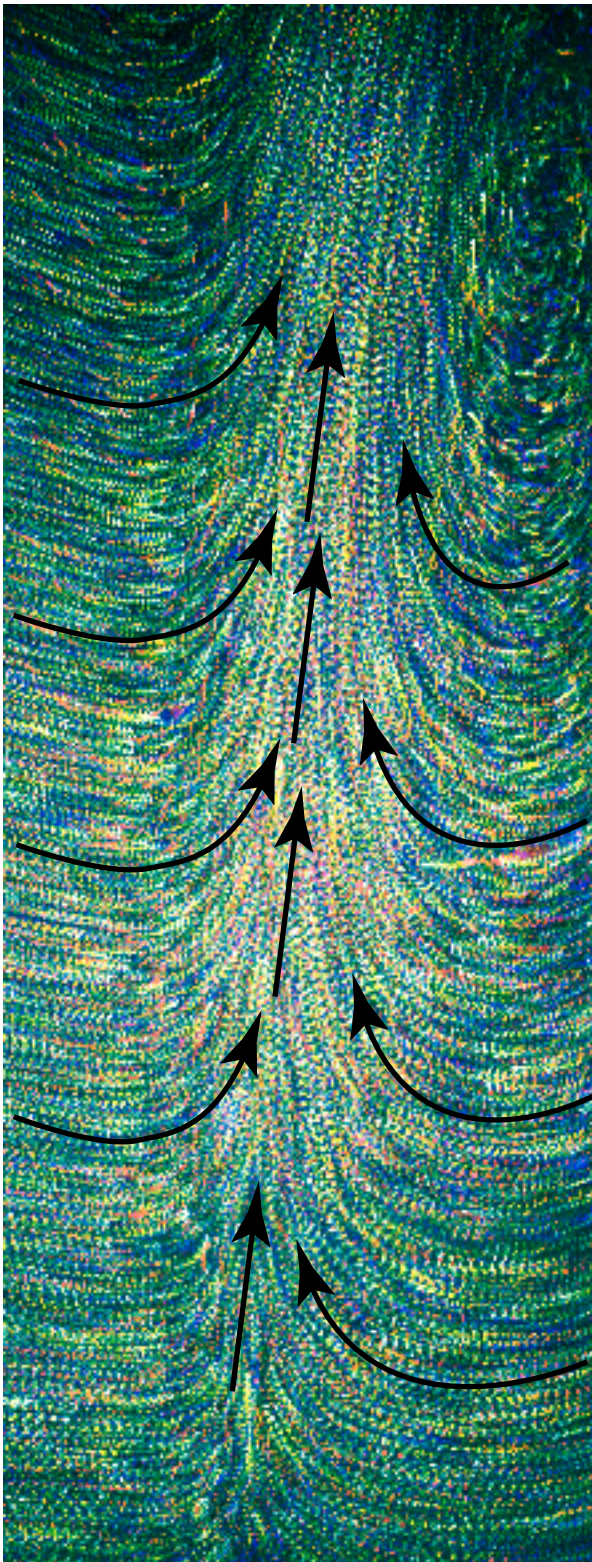

Figure 1. Streak representation (false color) of experimental convective thermal transport structure in rotating convection. Arrows indicate the up flow direction of the warm fluid.

References

1. Charney, J.. On the scale of atmospheric motions. 1948. Gofysiske Pulikasjoner. 17 (2): 3.

2. Whitehead, J., and B. Wingate. The influence of fast waves and fluctuations on the evolution of the ‘slow manifold’. To appear in Journal of Fluid Mechanics.
3. Whitehead, J., T. Haut, and B. Wingate. The effect of two distinct fast time scales in the rotating stratified Boussinesq equations. Nonlinearity.
4. Haut, T., and B. Wingate. An asymptotic parallel-in-time method for highly oscillatory PDEs. 2014. SIAM Journal of Scientific Computing. 36 (2): A693.
5. Haut, T., T. Babb, G. Martinsson, and B. Wingate. A high-order scheme for solving wave propagation problems via the direct construction of an approximate time-evolution operator. IMA Journal of Numerical Analysis.
6. Ecke, R. E., and J. Niemela. Heat transport in the geostrophic regime of rotating Rayleigh-Benard convection. 2014. Physical Review Letters. 113: 114301.

Publications

Haut, T. S., and B. A. Wingate. An asymptotic parallel-in-time method for highly oscillatory PDEs. 2014. SIAM Journal of Scientific Computing. 36 (2): A693.

Haut, T., T. Babb, G. Martinsson, and B. Wingate. A high-order scheme for solving wave propagation problems via the direct construction of an approximate time-evolution operator. IMA Journal of Numerical Analysis.

Whitehead, J. P., T. Haut, and B. Wingate. The effect of two distinct fast time scales in the rotating stratified Boussinesq equations. Nonlinearity.

Whitehead, J. P., and B. Wingate. The influence of fast waves and fluctuations on the evolution of the ‘slow manifold’. To appear in Journal of Fluid Mechanics.

A Novel Mo-99 Separation Process Designed for Next Generation Medical Isotope Production

Iain May
20120255ER

Abstract

Tc-99m, the daughter product of Mo-99, is the most commonly utilized radioisotope in nuclear medicine. The majority of the US supply of Mo-99 for nuclear medicine is produced in aging foreign reactors using highly enriched uranium (HEU) targets, with 6 % of U-235 fission events resulting in the formation of Mo-99. Recent maintenance and repair shutdowns of these reactors have significantly disrupted the supply of Mo-99 in the US and most of the rest of the world, with one reactor scheduled to cease production completely in 2016. To compound the problem, the short 66 h half-life of this radioisotope prohibits the build-up of reserves.

New technologies have been proposed for domestic US production of Mo-99, none of which requiring the use of HEU, the use of which creates proliferation concerns. These technologies include low enriched uranium (LEU) acidic solution fuel approaches, such as the Aqueous Homogenous Reactor concept. Equally, certain LEU solid targets could be dissolved in nitric acid, providing another potential acidic feed solution for the chemical recovery of Mo-99. In this context there is both interest in developing domestic Mo-99 production and chemical processing facilities based on LEU solid targets, and an ongoing overseas HEU to LEU solid target conversion programs. In all cases, using LEU vs. HEU will result in higher uranium to Mo-99 ratios in the fuel solutions post-irradiation. For irradiated uranium nitrate solutions we have developed a novel separations flow sheet that begins with a uranium nitrate crystallization step to remove the majority of the LEU. Once the majority of the LEU has been removed the Mo-99 can then be recovered using a conventional alumina column separation process. Our results indicate that high yield recoveries of both Mo-99 and LEU can be obtained using this combination of separation techniques. Such a Mo-99 recovery process is equally applicable to production methods based on uranium nitrate solution fuels and appropriate solid target fuels.

Background and Research Objectives

Mo-99 is a radioactive isotope that decays to Tc-99m, the most important radioisotope in nuclear medicine. Tc-99m is uniquely suited to a wide range of medical imaging procedures and accounts for >80% of radiotracers used in diagnostic nuclear medicine and > 85 % of all radioisotope procedures (> 13 million procedures per year in the US). The majority of the world's supply of medical isotope Mo-99 is produced from the fission of U-235 in high enriched uranium (HEU) in overseas reactors, many of which are aging and increasingly unreliable. The use of HEU raises proliferation concerns, while the lack of domestic production of Mo-99 here in the US leads to supply concerns. Apprehension related to such issues is heightened by the fact that a major producer, The National Research Universal Reactor in Chalk River (Canada), will cease production in 2016. To address these issues the NNSA Global Threat Reduction Initiative (GTRI) effort is focused on accelerating the establishment of a reliable supply of medical isotope Mo-99 produced without HEU by establishing partnerships with South Africa, Belgium and the Netherlands to convert Mo-99 production from HEU to LEU targets, and with domestic commercial entities to produce Mo-99 in the United States with non-HEU technologies.

There are multiple technologies proposed for the production of ^{99}Mo without the use of HEU. A number of these technologies, such as the Aqueous Homogenous Reactor, require LEU fuel in solution form. The target solution would typically contain uranium as the uranyl(VI) dication as nitrate or sulfate salts in dilute acid. Titania based sorbents have been applied to the initial recovery of Mo-99 from the vast excess of uranium present in such solutions, a material not commonly utilized in separations for medical isotope Mo-99 chemical processing. In addition, the conversion from the irradiation of HEU to LEU solid targets, and thus to a uranium fuel source with less U-235, leads to an increase in number of targets, processing runs and waste volume. Finally,

while uranium recycle can more readily be applied to solution target concepts most current solid target flow sheets are not well suited to uranium recycle. In all the aforementioned cases the design of novel chemical processes that simplify the recovery of Mo-99 from irradiated LEU, while minimizing the generation of uranium containing waste, would be extremely beneficial.

In this project we proposed to develop a novel process that would allow efficient Mo-99 recovery after production, and present the potential for the recycle of LEU. The process we envisioned comprised steps that are known individually but have not previously been integrated into a technology applicable to Mo-99 recovery. The initial research involved installation and validation of all aspects of the chemical separation processes: the evaporation, crystallization and solid sorbent separation stages. This was achieved using simplified solution matrices. Specialized apparatus was evaluated for several of these individual operations, including utilizing automation where possible. Our objective was to prove that this “inventive application” of apparatus and individual chemical separations could result in an integrated process that could successfully separate Mo-99, at the bench top scale in a radiochemistry facility, from LEU solutions irradiated at LANSCE (Los Alamos Neutron Science Center). Irradiated solutions would be tested (variation in uranium concentration, nature of the dilute acid) to evaluate the best solution conditions for both Mo-99 production and separation.

Scientific Approach and Accomplishments

The “inventive application” of individual separation processes that we successfully demonstrated is outlined in Figure 1. This figure is very similar to the one produced in the initial proposal, a good indication that most of our technical challenges were overcome in the course of the research. Our aims were three-fold:

- An initial separation of the majority of the LEU from a solution rich in Mo-99.
- The subsequent chemical column recovery of Mo-99 using the ‘industry standard’ sorbent, alumina.
- The minimal use of additional chemicals, in this case we proposed to only use nitric acid and alumina.

The initial step of this process was the dissolution of a solid irradiated LEU target in nitric acid, or the conditioning of irradiated LEU in a dilute nitric acid solution target. In both cases the goal was to produce a solution rich in nitric acid but, based on the original solution target focus of the project and 3 year project timescale, we worked only with irradiated LEU nitrate solutions. However, we believe that

the flow sheet could work equally as well with an irradiated LEU solid target that could readily be dissolved in nitric acid. The high nitric acid and uranium concentration solution could then be evaporated under reduced pressure and/or the temperature lowered to crystallize out uranium as a hydrated di-nitrate product. Our hypothesis was that the majority of the uranium would now be present in a solid phase which could be separated from a solution containing the majority of the Mo-99. The uranium product would then be in a chemical form that could be readily converted into new target ‘fuel,’ if recycle were an option, or a stable waste form if recycle were not required. The remaining Mo-99 rich solution would contain excess nitric acid which would need to be removed through evaporation, but the much lower uranium concentration of this solution would allow for Mo-99 recovery using an alumina column. Alumina is a sorbent used almost exclusively in Tc-99m generators, the Mo-99 binding to this material as molybdates (HMoO₄⁻/MoO₄²⁻) while the Tc-99m is ‘milked’ from the generator in saline solution as pertechnetate (TcO₄⁻). Alumina can also be used for Mo-99 purification during recovery from irradiated LEU, but a vast excess of uranium (and hence nitrate) prevents efficient binding to alumina in dilute acid prior to recovery of the isotope by elution in basic solution. Through the initial crystallization of excess uranium we hypothesized that a high yield recovery of further purified Mo-99 could be obtained through alumina column separation from the remaining uranium.

In the early stages of the project LDRD-ER funds provided support towards the purchase of both a Buchi Multivapour P-12 and a Syrris™ Atlas Potassium Reactor System, providing automation capabilities for the evaporator and crystallization stages of the flow sheet respectively. In particular, the reactor system proved extremely useful for careful optimization of uranium crystallization conditions, development work undertaken with depleted uranium, and for reproducibility control of the crystallization of LEU during irradiated solution tests. Another vital early ‘proof of concept’ experiment led to the confirmation that Mo-99 largely stayed in the supernatant after crystallization of depleted uranium from a nitric acid solution spiked with Mo-99 that had been milked from a Lantheus™ generator. Finally, a key capability development early in the project related to realization of a new capability for LEU solution sample irradiation at Target 4, LANSCE. The project helped support the development of this capability, which included the design and build of both sample containment and a remote sample delivery and retrieval system. Pictures showing some of the technical capabilities developed for this project are shown in Figure 2.

With all of the key capabilities in place, and “show stop-

per” experimental parameters tested, it was possible to undertake experiments to validate the full flow sheet outlined in Figure 1 from stage 1a through stage 5. This flowsheet was both tested, and subsequently refined, using LEU target solutions irradiated at LANSCE. The crystallization process proved to be successful, with the recovery of the majority of the uranium as a crystalline solid product leaving almost all the Mo-99 in solution (Figure 3). In addition, most of the other radioisotopes produced during irradiation, that we could readily measure, remained with the Mo-99 product (Figure 3). This resulted in a partially purified uranium product, the comparatively low level of radionuclide contaminants of value both in terms of ease of recycle and/or ease of waste disposal. The Mo-99 rich solution could then be further purified using an alumina column after solution conditioning to remove excess nitric acid, as had been proposed. The comparatively low uranium concentration in the column feed solution allowed for near quantitative Mo-99 recovery (Figure 4). While numerous modifications were made to the process during the three sample irradiations, and subsequent separations chemistry, the most valuable process enhancement involved the maximization of % Mo-99 recovery – particularly during the crystallization and subsequent initial uranium separation step.

Removal/addition of water and/or nitric acid from processing solutions was a key component of this project. In practice simple, well defined, fume hood based stirrer hot plate operations were employed to undertake this task when working with irradiated LEU samples. However a more automated evaporator system could also be deployed for these relatively simple chemical operations. To this end we utilized a Buchi Multivapour P-12 to confirm that both nitric acid and water could be efficiently removed from uranium solutions (using depleted uranium) under both reduced pressure and lower temperatures.

Originally we had planned to develop the flow sheet outlined in Figure 1 for LEU sulfate solutions. However, experimental work studying uranium sulfate crystallization revealed complexities in the uranium sulfate chemistry that were not present with uranium nitrate chemistry. When writing the original proposal we acknowledged that the sulfate chemistry would likely be more challenging. Due to these chemistry challenges and the more general applicability of developing our flow sheet idea for uranium nitrate vs. uranium sulfate, sulfate fuel being applicable only to certain solution target concepts for Mo-99 production and of limited applicability to solid LEU target processing, we focused our attention on the nitrate system.

At the start of the project we submitted an IDEA through the LANL system and towards the end of the second year

of the project we had enough results to prove that the key components of the proposed flowsheet could be realized, at least at the laboratory scale. This allowed us to develop, and submit, two patent applications based on this work. Until this point our desire to protect the intellectual property generated both in the initial proposal, and the subsequently obtained results, had stopped us from publishing experimental details in peer reviewed scientific journals. However, in the Spring and Summer of 2014 we have presented our results in a non-enabling format as talks at three major conference: - the 38th Actinide Separations Conference (May, Albuquerque), the Mo-99 Topical Meeting (June, Washington D.C.) and at the 8th International Conference & Expo on Isotopes (August, Chicago). We have received positive feedback regarding our work from within the Mo-99 production community, including interest from a company seeking to produce Mo-99 domestically here in the US. We are currently working through a CRADA (Cooperative Research and Development Agreement) with this company with the aim of initiating a cooperative research program which will include aspects of this LDRD-ER research. In addition, we have drafted manuscripts for submission to peer reviewed journals as, and when, we believe that the timing is appropriate.

This LDRD-ER project has provided training and career development for a postdoctoral researcher, Dr Roy Copping. Copping has made major contributions to this work over the past 3 years, more often than not leading the chemical component of the technical effort. In June 2014 he received an award for the quality of the poster he presented at the Los Alamos post-doc day, an award that only 10 % of all the participants received. Dr Copping will soon be employing many of the skills he has developed and honed working on this LDRD-ER proposal in his new role as a Research and Development Staff Member within the Nuclear Science and Engineering Directorate at Oak Ridge National Laboratory.

Impact on National Missions

The US requires domestic production of medical isotope Mo-99 from LEU, both to ensure continuous supply of this important medical isotope and to eliminate dependence on the international use of HEU for Mo-99 production. Developing a US Mo-99 domestic supply thus addresses two national security needs, secure medical isotope production and lowered proliferation concerns through elimination of HEU use. Additionally, the elimination of HEU use for Mo-99 production in overseas reactors would also lower proliferation concerns. It is with such a national security background that the NNSA Global Threat Reduction Initiative (GTRI) effort is focused on the Mo-99 production related missions outlined previously. It is in this context that

we have provided regular updates of the research results we have obtained through this LDRD-ER project to the GTRI program, primarily through the appropriate program leads at LANL.

This LDRD-ER funded project has allowed us to develop a novel separation science solution to the recovery of Mo-99 from a vast excess of irradiated LEU. If developed from our proof-of-principle lab scale to commercial application this separation scheme could be applied to the recovery of Mo-99 from either irradiated solid or irradiated aqueous solution LEU targets. It could also be used to convert existing HEU chemical processing capabilities for Mo-99 recovery to LEU processing. We have thus demonstrated LANL's capability in developing technical solutions to chemical processing problems of direct relevance to interlinked challenges related both to medical isotope production and lowering nuclear proliferation concerns.

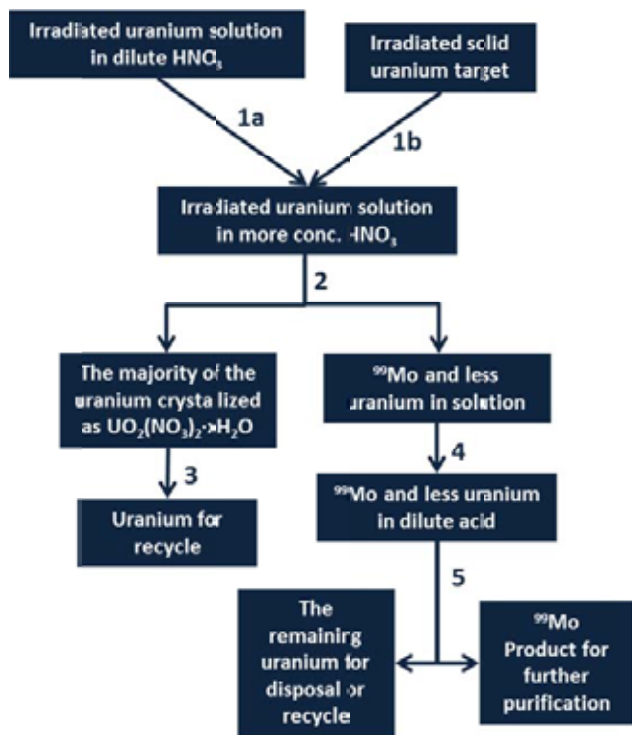

Figure 1. Flowsheet outlining the "Inventive Application" of Individual Separation Processes for the recovery of medical isotope Mo-99 from an excess of Low Enriched Uranium.



Figure 2. Examples of experimental apparatus used during the course of this project. Top left – the Target 4 capability at LANSCE for LEU solution sample irradiations. Top center – the sample containment for the irradiated LEU solutions, as shown being placed into a Viking shipping container for return to the radiochemistry laboratories for separation chemistry. Top right - the Syrris Atlas Potassium Reactor System used to carefully control the LEU uranium crystallization process. Bottom – a close up of the Syrris Atlas Potassium Reactor System showing the crystallized hydrated uranyl nitrate solid product under a supernatant solution containing significantly less uranyl (and hence uranium) in solution.

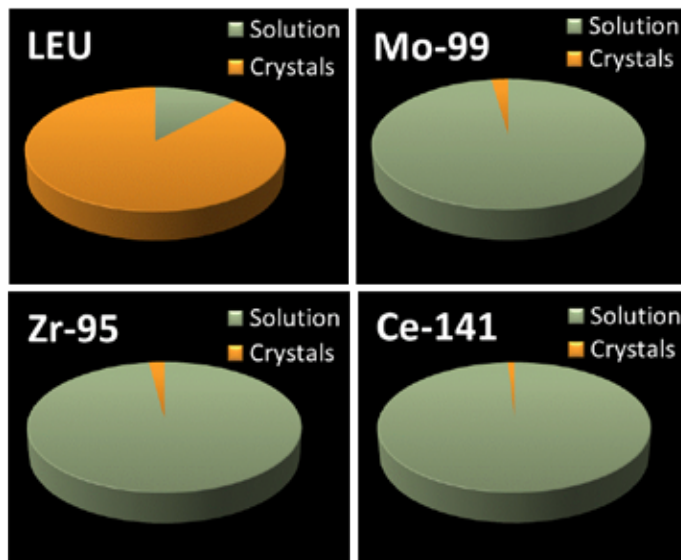

Figure 3. Pie charts that indicate the distribution of low enriched uranium, Mo-99, Zr-95 & Ce-141, between crystallized hydrated uranyl nitrate and the remaining supernatant (solution) after the crystallization process was used to remove the majority of uranium from an irradiated LEU solution.

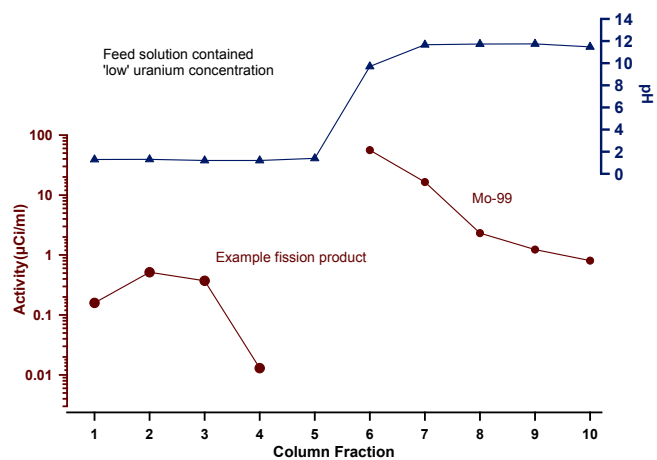

Figure 4. Alumina column separation experiment undertaken on the Mo-99 rich solution fraction that remained after crystallization of the majority of the uranium present in an irradiated uranium nitrate solution. Fraction 2 contained the feed solution that had passed through the column. As base was passed through the column the Mo-99 was stripped as a relatively high concentration/low solution volume product that would then require only final purification.

Biofuel Enzymes by Design

William M. Chalacombe
20120256ER

Abstract

This work uniquely combines novel $O(N)$ methods for Quantum Chemistry with recent progress in Neutron Crystallography with the goal of understanding extremely complex enzyme mechanisms that are delocalized over 100s of atoms. This approach works well when the underlying data is of a high quality. Unfortunately, a serious lack of quality was only discovered after extensive efforts to reconcile related data sets. The defects in the data have been addressed through a consensus approach combined with Monte-Carlo simulation. This and a number of other setbacks will delay publication of our results by probably one year. However, the outlook for positive results is high, and the difficult lessons learned are extremely valuable going forward.

Background and Research Objectives

The goal of this research was to exploit the overlapping synergy between neutron/x-ray crystallography and large scale electronic structure theory applied to biomolecular simulation: Is it possible to employ knowledge of proton positions and theory to model important reaction sub-states, including bound intermediates and transition states, and to use this information in enzyme engineering. Originally, this approach was focused on just Xylose Isomerase. After experimental collaborator Andrey Kovalevsky left LANL, the project was refocused around Carbonic Anhydrase and experimental collaborator Zoe Fisher. After Zoe Fisher left LANL, the project was refocused on DFPase and experimental collaborators Bob Williams and Julian Chen.

Scientific Approach and Accomplishments

Our approach to modeling involves large quantum only subsystems, typically involving 300-500 atoms in size, and using optimization techniques to locate mechanistically and energetically meaningful results that explain enzyme mechanism, and ideally provide insights that can be turned into engineering principles. For the large,

multi-step problem of Xylose Isomerase, we were able to achieve this objective for the isomerization step, but not for the ring opening step. This resulted in a paper explaining seven unrelated experimental observations of the isomerization, including a second hidden water position in one of the intermediates. However, after intense scrutiny of the ring opening mechanism (due to bad energetics), we discovered that two of our neutron data sets were each missing different water molecules towards the edge of our models. We were able to make this discovery only through by hand curation involving ~20 structures. Now partially based on very high resolution x-ray data from the '90s, the corrected model is being re-annealed by Monte-Carlo optimization, so far showing dramatically decreased water RMSD positions between open and closed ring substructures, which are encouraging. It remains to be seen if our conclusions regarding isomerization remain valid, or if they must be revised in light of the more complete model. Despite many setbacks (collaborators leaving, bad initial data, budget reduction), the outlook for this work is still very positive, and is set to achieve results with minimal effort, involving primarily collecting data from long-running calculations.

With DFPase, significant progress has been made towards developing new and testable mechanistic hypotheses, based on recent x-ray data from the work of Julian Chen (unpublished), existing neutron data and large quantum-only models. Preliminary data show that existing models for the mechanism of this enzyme are almost certainly incorrect. Publications for this work will hopefully be forthcoming in 2015, again resulting from in place, long running calculations.

Impact on National Missions

This work involves a high impact biofuels enzyme, Xylose Isomerase, and a high impact biothreat countermeasure, DFPase. It is the first work to explore the use of large quantum-only enzyme models, and amongst the first

based on neutron data. While faster quantum chemical methods would have helped this effort, the big challenge has been to build high confidence models based on many overlapping crystallographic data sets. These results suggest the need and opportunity for structural informatics & curation protocols, which are currently unavailable. Although still probably a year out, we remain positive that this work will provide engineering level understanding of large delocalized enzyme mechanisms for the design of enzymes critical to biofuels and biothreat countermeasures.

Publications

Kovalevsky, A. Y., B. L. Hanson, S. A. Mason, T. Yoshida, S. Z. Fisher, M. Mustyakimov, V. T. Forsyth, M. P. Blakeley, D. A. Keen, and P. Langan. Identification of the Elusive Hydronium Ion Exchanging Roles with a Proton in an Enzyme at Lower pH Values. 2011. *Angewandte Chemie*. 123 (33): 7662–7665.

Waltman, M. J., Z. K. Yang, P. Langan, D. Graham, and A. Kovalevsky. Engineering Acidic *Streptomyces rubiginosus* D-Xylose Isomerase by Rational Enzyme Design. 2014. *Protein Engineering Design and Selection*. 27 (2): 59.

High-Energy Segregated Fuel-Oxidizer Solid Rocket Propulsion System

Bryce C. Tappan
20120285ER

Abstract

Current solid propellant systems have proven reliable over the decades but have long since reached their limit in terms of achievable system safety and performance. Despite this, the US DoD, NASA and commercial organizations continue to request increasingly higher-energy systems with an increased level of safety. The demand for safer systems is becoming more relevant with the recent boom in commercial space endeavors, particularly when considering space tourism with manned flights. This safety consideration has brought forth a revival in solid fuel/liquid oxidizer hybrid rockets, despite the inherent problems of these systems such as low mass-burning rates requiring large surface areas in the fuel section to achieve the same thrust as solid propellants. The two characteristics of increased safety and higher performance, however, are almost always mutually exclusive, being that typically the higher energy systems almost always have the penalty of being higher hazard. The aim of the proposed effort is to develop a segregated fuel/oxidizer propellant system that would be a major break-through in solid rocket propulsion in terms of safety and energy. The proposed system is a combination of novel materials that allow for a radically new engineering design. Because of the development of high-nitrogen/high hydrogen energetics at LANL that contain little or no oxygen, a segregated tandem system can be designed such that the burning energetic materials will provide fuel from their decomposition that will be oxidized in a separate chamber by reaction with a solid oxidizer. Because the fuel and the oxidizer will remain separated until combustion of the fuel is initiated, and are both are relatively (or completely) insensitive to shock, the chance of accidental detonation or initiation of the rocket is dramatically reduced. This provides an unprecedented level of safety, opening up previously inaccessible utilization of higher energy components, thereby exceeding performance of state-of-the-art solid propellants.

Background and Research Objectives

The field of chemical rocket propulsion has become highly developed only in the past century (even though the Chinese had used rockets over 800 years ago) and has not seen a fundamentally different concept since nearly WWII.[1] Currently, the term propulsion is used very loosely in the aerospace field in terms of forces propelling an object through a medium. Fundamentally, propulsion is defined as the process of changing the motion of an object (e.g. rocket, missile) that is initially at rest or changing velocity to overcome incident forces while passing through a specific environment. Jet propulsion, a subset of general propulsion, is defined by the movement of a body or object generated by the momentum resultant force of ejected matter out of the tail end. Although rocket propulsion is indicated as a form of jet propulsion, the matter ejected out of the nozzle is stored on board. This matter is called propellant. The most widely used source of energy for rockets is chemical combustion, as is the case in the proposed work. Diagrams for three types of existing chemical propulsion rockets including liquid propellant, solid propellant, and hybrid rockets are shown in Figure 1, along with the segregated energetic fuel/oxidizer concept proposed here.

Chemical reactions between the propellant components release thermal energy in the combustion chamber that is then converted to kinetic energy by the expansion of the combustion products through the nozzle. The overall efficiency and performance parameters of the rocket depend largely on the choice of fuel and oxidizer, which are considered as the two reacting components of most chemical propulsion systems. When a system is considered a liquid or bi-propellant rocket, both the fuel and oxidizer are in liquid form, and are often amongst the most poisonous, unstable and generally hardest to handle ingredients used for large-scale engineering applications. Commonly used liquid oxidizers include liquid oxygen (LOX), liquid fluorine (LF2), hydrogen peroxide (H2O2), various nitric acids [HNO3, red fuming nitric

acid (RFNA), inhibited red fuming nitric acid (IRFNA), and nitrogen tetroxide (N₂O₄). Bi-propellant fuel ingredients, like the liquid oxidizers, often include a witches brew of dangerous chemicals including liquid methane (LCH₄), ethanol, methanol, kerosene, liquid hydrogen (LH₂), hydrazine (N₂H₄), unsymmetrical dimethylhydrazine [(CH₃)₂NNH₂ or UDMH], and monomethylhydrazine (CH₃NHNH₂ or MMH). If the fuel and oxidizer are combined in solid form, either chemically in the case of homogeneous propellants or physically for heterogeneous propellants, the rocket is called a solid propellant rocket.[2] Ammonium perchlorate (AP), a solid oxidizer, is commonly used with a solid fuel of hydroxyl-terminated polybutadiene (HTPB) to form a composite propellant. The third type is hybrid rocket propulsion. The classical hybrid propulsive system combines an inert solid fuel contained within a combustion chamber with a separately stored liquid, gaseous or gel oxidizer, flowed through porting within the grain at the time of ignition. Once ignited, pyrolyzing solid fuel mixes and combusts with atomized liquid oxidizer producing high pressure, high temperature propellant gas. The attractiveness of hybrid system applications becomes evident when observing the simplicity of design, high level of operational safety, the diverse spectrum of applications, on/off and throttle tailoring capability, storage life and production costs.[2-5] Despite the many safety and operational advantages inherent in the hybrid propulsive system, low solid fuel regression rates requiring a relatively large fuel surface area to attain a given level of thrust is the primary drawback in addition to a tendency to not completely react before the products exit the chamber.

The aim of this effort was to develop a segregated fuel-oxidizer propellant system (SFOS) that could be a major breakthrough in solid rocket propulsion in terms of safety and energy. The proposed system is a combination of novel materials that allow for a radically new engineering design. Because of the development of high-nitrogen/high hydrogen energetics at LANL that contain little or no oxygen, a segregated tandem system can be designed such that the energetic material will provide fuel from their decomposition that will be oxidized in a separate chamber by reaction with a solid oxidizer. Because the fuel and the oxidizer remain separated until combustion of the fuel is initiated, and are both relatively (or completely) insensitive to shock, the chance of accidental detonation or initiation of the rocket is dramatically reduced. These technologies that will allow for both a higher energy and much safer solid propellant propulsion system then is currently offered the state-of-the-art. The primary advantage in this system will be in the safety gained from having physically separated fuels and oxidizers. Because of the safety gain, standard ingredients such as AP and Al can be replaced by ADN and

Al-hydride. Nano Al can also be used to modify burning rates without safety penalty, and in fact will decrease sensitivity when added to an energetic fuel, where as formulations with an oxidizing mixture will become prohibitively sensitive.[6]

Scientific Approach and Accomplishments

LANL is one of the world's foremost institutions in the synthesis and characterization of new high-nitrogen (HiN) energetic materials. This class of C, H and N compounds has little or no oxygen, but retain energetic material properties as a result of their inherently high-energy due to nitrogen in a highly strained state. Therefore, the decomposition lacks secondary oxidation reactions of carbon and hydrogen, and any fuel molecules present are thus available for secondary oxidation. This is important for two reasons: one being that because of efficient crystal packing the fuel content, particularly hydrogen, can be extremely high; commonly exceeding that of liquid hydrogen. And secondly, because oxygen is not carried on the molecule, high-energy additives such as nanoparticulate aluminum and aluminum hydride can be formulated with HiN fuel; which when added to a typical solid propellant would result in a mixture with extreme explosive sensitivity. One such material is triaminoguanidinium azotetrazolate (TAGzT), which served as the initial fuel material in formulations for the project.[7] As the project progressed, other materials were evaluated, and more cost-effective formulations were developed based on triaminoguanidinium nitrate (TAGN), which produced the same level of hydrogen fuel, but with much greater combustion stability, resulting in more reliable motors.

A simplified model was developed to determine nozzle specifications and instantaneous pressure-time profiles for solid rocket experiments. This was then used to predict a series of nozzle diameters and pressure profiles for TAGzT burning under specific operating conditions and propellant geometry. As the nozzle size is decreased, the chamber pressure increases, thus decreasing burning time. Continued testing is ongoing to find the correct nozzle geometry to provide a neutral pressure-time profile using TAGzT end burner grains. One of the key observations of this project is that high-nitrogen/hydrogen fuels are subject to greater combustion instability than classic propellants, which often leads to over or under-pressurization in the chamber. This problem is being addressed by evaluation of new propellant formulations, a number of which have been evaluated and pressure vs burning rate graphs have been determined. To aid in the more rapid completion of this work, a new strand burner was built and provided by Penn State.

Additionally, the mechanism of this instability leading to

failure is under investigation in collaboration with C-PCS using their fast x-ray imaging technique. For this an x-ray transparent motor built and utilized to capture images of the motor interior during combustion, as experiment rarely utilized in rocket motor combustion.

A series of opposed flow tests at atmospheric pressure to determine the burning rate of TAGzT as a function of oxygen flow rate were performed. It was demonstrated that there is a critical amount of oxygen that is required to accelerate the burning rate until the heat transfer overwhelms the energy liberated by the combustion process. Finer resolution testing between 0 and 1 liter/minute oxygen flow will commence in the near future. As the delivery rate of the oxygen supplied to the surface is increase, the slope of the position time profile also increases; indicating the available oxygen to the surface increases the heat feedback to the surface. Under high pressures, this phenomenon may be less significant. A solid propellant opposed flow burner for elevated pressures was designed and fabricated at Penn State. This is currently being used to examine gap distance and pressure effects on burning rate of the fuels and oxidizers, and will provide kinetic data of interactive reaction of the two materials. Interestingly, in the full motor testing of TAGzT formulations feeding product gases into AP pellets has shown that the rate of AP reaction is dependant mostly on the rate of the fuel products delivery to the oxidizer material, which was one of the main goals of this work, and will greatly simplify future utilization of this technology. The solid propellant opposed flow burner should be able to quantify this effect with various different fuels and oxidizers.

Utilizing lessons learned and testing in the duel chamber thrust stand motor, fuel and oxidizer ratios were optimized as well as fuel and oxidizer formulations. It was found that the best oxidizer performance was obtained with a small amount of various catalysts added to the grain, and when motor pressures were around 800-1000 psi. With successful lab tests in hand with motors up to 2" in diameter, a flight motor was designed, Figure 2, built and tested in static firings. Specific impulse of the baseline LANL motor combination was ~220 seconds, which compared ~217 seconds for the ammonium perchlorate/hydroxy-terminated polybutadiene (AP/HTPB) baseline motor, but thrusts were roughly 2-3 times greater, Figure 3.

The close out experiments of the project involved assistance from New Mexico Tech, with students and advisement from Prof. Michael Hargather. A 2" diameter by 41" high rocket was built from a commercially available body, and carried a telemetry package for velocity and altitude measurements, as well as an onboard camera. Figure 4 shows a frame sequence of the commercial (AP/HTPB)

baseline motor lifting off the pad vs the LANL SFOS motor, with two notable differences, the LANL system has much less visible exhaust products, and the time for the rocket to leave the field of view is ~0.1 seconds compared to the ~0.3 seconds of the AP/HTPB motor. Review of the telemetry data in Figure 5 provides graph of velocity versus altitude shows that the LANL motor accelerates to a significantly higher velocity shortly after liftoff than the commercial motor. This high velocity is due to the large thrust and short duration of the LANL motor. The high velocity decays quickly after the motor burns out, which happens in less than 1 second, and an altitude of just less than 200 ft. The velocity decays faster than the commercial motor because of the higher initial speed, thus greater drag, and the fact that the commercial motor continues to burn for 1.5 seconds, through an altitude of almost 300 ft, shown in the right hand side of Figure 5. The LANL motor achieves a lower apogee because of the larger drag due to the initially higher velocity compared to the commercial motor.

The technology was submitted for a US patent application and two follow-on patent disclosures will be submitted. Technical papers produced based on the basic research performed in this project have been submitted or accepted, most notably the cover issue of *Angewandte Chemie* published in August of this year.

Impact on National Missions

With the introduction of this project to the lab, the capability of propulsion system development has also been introduced, which did not exist at the level at which it does now. This has lead to new project aimed at in-house development of satellite propulsion systems, and will certainly lead to larger development projects in the future. The applicability of this work to the US DoD, NASA and commercial organizations is due to the higher-energy systems with an increased level of safety. The DoD runs the Joint Insensitive Munitions Technology Program, with a specific topical area to fund 6.2-6.3 levels of development of insensitive propellants systems, which will be a perfect fit for transition of this work owing to the safety of this system. NASA has various programs such as NextGen Concepts and Technology Development Project or Heavy Lift Propulsion Technology that could also benefit from the transitioning of research gains from this program.

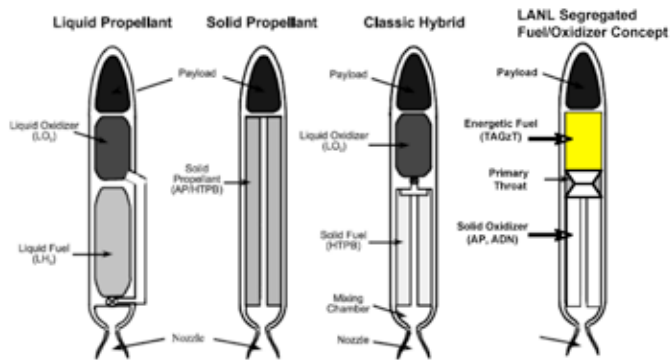

Figure 1. The three existing methods for chemical rocket propulsion in addition to the LANL energetic fuel/solid oxidizer system.

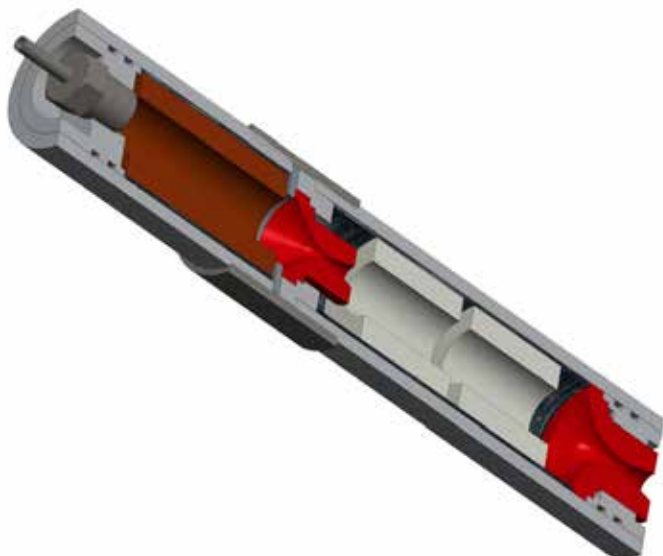

Figure 2. LANL SFOS flight motor

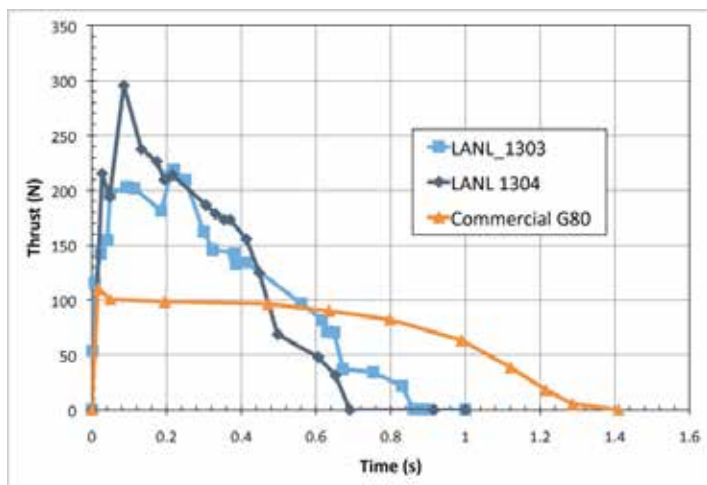

Figure 3. Thrust curves for LANL SFOS and ammonium perchlorate/hydroxy-terminated polybutadiene (AP/HTPB) baseline motor



Figure 4. Frame sequence of the commercial (AP/HTPB) baseline motor lifting off the pad vs the LANL SFOS motor.

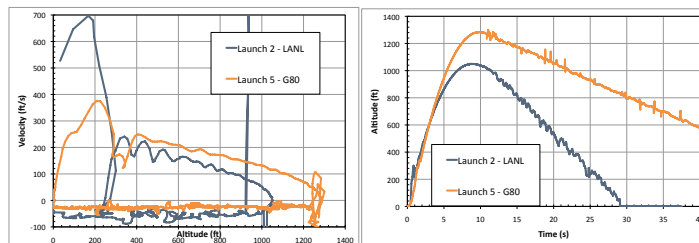

Figure 5. Data from on-board telemetry showing, left, velocity versus altitude and, right, altitude, of rockets with a commercial "G80" AP/HTPB motor vs the LANL SFOS motor.

References

Sutton, G. P.. Rocket Propulsion Elements: An Introduction to the Engineering of Rockets. 1992.

Chiaverini, M. J.. Fundamentals of Hybrid Rocket Combustion and Propulsion. 2007. Prog. Astronaut. Aeronaut.. (218): 2007.

Chiaverini, M. J., K. K. Kuo, A. Peretz, and G. C. Harting. Regression-rate and heat-transfer correlations for hybrid rocket combustion. 2001. Journal of Propulsion and Power . (17): 99.

Risha, G. A.. Enhancement of hybrid rocket combustion performance using nano-sized energetic particles. 2003. Pennsylvania State University, Ph.D. Thesis.

Risha, G. A., A. Ulas, E. Boyer, S. Kumar, and K. K. Kuo. Hybrid rocket combustion . Presented at 221st ACS National Meeting. (San Diego, 1-5 April 2001).

Tappan, B. C., S. F. Son, and D. S. Moore. Nano-aluminum reaction with nitrogen in the burn front of oxygen-free energetic materials. 2006. In AIP Conference Proceedings.

(Baltimore, 28 July 2006). , p. 1022. Baltimore: American Institute of Physics.

Tappan, B. C., A. Ali, S. F. Son, and T. B. Brill. Decomposition and ignition of the high-nitrogen compound triaminoguanidinium azotetrazolate (TAGzT). 2006. *Propellants, Explosives and Pyrotechnics*. (31): 163.

Publications

Risha, G. A., B. C. Tappan, A. M. Novak, E. V. Baca, and D. M. Oswald. Regression rate of TAGzT with various oxidizers in a stagnation flow configuration. *Journal of Propulsion and Power*.

Risha, G. A., B. C. Tappan, A. M. Novak, E. V. Baca, and D. M. Oswald. Combustion performance of HTPB-based solid fuels containing TAGzT. *Journal of Propulsion and Power*.

Tappan, B. C., M. R. Dirmyer, and G. A. Risha. Evidence of a kinetic isotope effect in nanoaluminum and water combustion. 2014. *Angewandte Chemie International Edition*. 53 (35): 9218.

Tappan, B. C., and D. E. Chavez. Combustion properties of amino-substituted guanidinium 4,4',5,5'-tetranitro-2,2'-biimidazolate(N4BIM) salts . *Propellants, Explosives and Pyrotechnics*.

Co-Evolution of Protoplanets and Transitional Protoplanetary Disks - Pathway to Giant Exoplanet Formation

Hui Li
20120399ER

Abstract

The past 20 years have witnessed the astonishing discoveries of nearly 2000 exoplanets and they have stimulated an explosive growth in studying the basic processes that regulate the planet formation. An equally dramatic discovery is that some protoplanetary disks show large (tens of astronomical unit) gaps and holes that are likely caused by the forming giant planets (e.g., Jupiter masses). Very recently, dust vortices have now been discovered along with their gaps. Studying the co-evolution of protoplanets and their nascent disks can hold the key to understanding the planet formation.

With this project, we have built new theoretical and computational capabilities to study these exciting systems. We have developed new 3D codes that study the disk-planet interactions. By implementing different viscosity in different disk regions in 3-D, we were able to examine how protoplanets have migrated in more realistic disk geometries and conditions. We found that protoplanets can undergo convergent migration into special regions of the disk and built up their masses through either accretion or mergers. This project has also enabled us to implement a new, efficient numerical algorithm that handles the dust dynamics in disks. Motivated by the new discoveries of dust vortices in protoplanetary disks, we have carried out extensive simulations to study the formation of vortices along with the dust dynamics. We discovered a new dynamic instability when the dust accumulation within a vortex exceeds the gas concentration. On one hand, this instability leads to the eventual disruption of the vortex. On the other hand, it offers a new exciting opportunity for the enhanced dust coagulation that leads to the formation of planetismals and eventual planets. Our simulations have been compared very favorably to the available observations and predictions for future observations are being tested as they become available.

Background and Research Objectives

The ~ 2000 discovered exoplanets have revealed an astonishing amount of diversity in their orbital properties (e.g., planet mass, semi-major axis and eccentricity). Because these properties are believed to originate from the early phases of planet formation when the protoplanets are still embedded in the protoplanetary disks, it is imperative to study the co-evolution of planet formation and their nascent disk evolution. Giant planets (Jupiter mass or higher) occupy a special place in the study of the planet formation. Their large masses (mostly gas) require that their formation timescale must be within the relatively short lifetime of the protoplanetary disk (a few million years) before the gas gets dispersed. At the same time, their large masses offer the unique opportunity of observing their influence on their nascent disks. It is this mutual interaction that is the primary focus of the proposed studies in this proposal.

A new chapter in protoplanet formation research is being written with the first light of ALMA in late 2011 (<http://www.almaobservatory.org/>). It is generally known that protoplanets are formed in the gaseous, dusty protoplanetary disks around young stars during the first few million years of the star's evolution. Thus far, some of the astonishing discoveries of ALMA include: a large-scale "horseshoe" feature in one disk that is believed to be "a formation site of giant planetary system"; and a major asymmetric "dust trap" in another disk. These pronounced features observed in the dusty protoplanetary disks are possible "signposts" of different stages of protoplanet formation. On one hand, these discoveries by ALMA are quite pleasant because our previous studies have predicted the production of vortices and non-axisymmetric features in disks. On the other hand, they are quite surprising because of the enormous size and presumed longevity of these asymmetries. The fact that dust is being trapped in these asymmetric features has profound implications for planet formation. Ever since the 70's, it is argued that it is impossible to

retain dusts in disks because they experience rapid radial drift (< 105 yr) and/or suffer fragmentation via collisions. Observations seem to support this idea. No dust growth, no planets.

The proposed work has been computationally intensive and it builds upon the unique strength at LANL where we have developed advanced disk+planet simulation tools. With the adaptive mesh refinement capability especially, we will be able to simultaneously capture the global protoplanetary disk dynamics together with resolving the accretion through a much smaller circumplanetary disk around the planet. Utilizing LANL's advanced capabilities in theory and computing, we have produced several important new results that are making an impact in this rapidly developing field, especially when a new era has started with the advent of ALMA and EVLA observations with unprecedented sensitivity and spatial resolution.

Scientific Approach and Accomplishments

With this project, we have performed extensive numerical simulations of disk+planet systems both in 2-D and 3-D, examining a range of key physics processes that directly determine the co-evolution of protoplanets and their disks. These include: first, how will the disk structure formation (gaps, holes and vortices) depend on the disk viscosity, planet mass and planet orbital eccentricity and how will they in turn affect the planet migration? Second, how will the disk evolution affect the formation and migration of multiple protoplanets and their final orbital distributions? Third, how will the dust evolve in the presence of disk gas vortices and will dust accumulate in vortices? These numerical studies have been compared with several observations that lead to important constraints on the planet formation processes. The confluence of advanced theory/numerical modeling with the new observations has enabled us to make an important contribution to this thriving field.

With this LDRD project, we have made progress on several fronts:

New simulation capability development

We developed a new 3D simulation code using C++ for 3D planet-disk interaction problem. We solve the full 3D Navier-Stokes equations by directional split Godunov method. We extend the FARGO scheme of Masset and modified by ourselves to our 3D code to accelerate the transport in the azimuthal direction. We also use a sub-cycling technique for the azimuthal sweep to alleviate the time step restriction. We have implemented a reduced 2D and a fully 3D self-gravity solver on a uniform disk grid, which extends our 2D method to 3D. This solver uses a mode cut-off strategy and combines FFT in the azimuthal direction and

direct summation in the radial and meridional direction. We do not need any softening in the disk self-gravity calculation as we have used a shifted grid method to calculate the gravitational potential. We also develop a method to generate an initial axis-symmetric equilibrium disk via iteration between the disk density profile and the 2D disk-self-gravity.

We have also developed and implemented a new bi-fluid model for dusty protoplanetary disks for both our 2D and 3D codes. The dust particles are treated as a pressureless fluid and evolved according to the hydrodynamic equations. The coupling between the gas and dust in a disk is through the drag force, which causes the dust particles to drift inward in the radial direction. We have performed extensive tests of our model and code using the theoretical results in the literature and our numerical results are in good agreement with the theoretical prediction. In addition, we have implemented dust diffusion due to the turbulent motion of the gas in a disk. We have modified the dynamic equations of the dust so that they are consistent with the dust diffusion. This procedure removes the possible instability caused by the dust diffusion. We have performed simulations to study the dust settling in the vertical direction of 3D disk due to the dust diffusion and obtained similar results to the theoretical prediction. In summary, the numerical package we have developed for studying planet-disk interaction as well as dust dynamics, we believe, is state-of-the-art. We have been able to perform much longer simulations compared to what have been published by other groups. We have found that some key previous conclusions based on short-time runs by other groups were not correct.

3-D density feedback effects

A large set of 3-D simulations were performed to study the density feedback effect which influences the rate of planet migration in low viscosity disks. We have shown that this feedback effect is still present in 3-D, similar to what we have discovered before in 2-D disks. The effectiveness in 3-D, however, is different from 2-D. These results have been published. This represents the first 3-D study on the density feedback effect in low viscosity disks and it has important implications for the Type-I migration problem.

Multiple Planets

By carefully analyzing the existing database of exoplanets, we found that, among 160 of the multiple exoplanetary systems confirmed, about 30% of them have neighboring pairs with a period ratio less than 2. An interesting feature is that a significant fraction of these pairs are around mean motion resonance (MMR). This means that, when there are multiple planets in one system, they eventually migrate together and through experiencing each other's

gravitational forces, they eventually locked into resonances in their orbits. More interestingly, many of them are locked with orbital frequency ratios of 2:1 and 3:2, but with a clear absence of more closely packed MMRs with period ratios less than 4:3, regardless of planet masses. By performing extensive numerical simulations of multiple planets with various mass groups, we have demonstrated that such MMR behavior places important constraints on the disk evolution stage out of which the observed planets formed. In particular, we concluded that the dynamical architecture of most low-mass-planet pairs (tens of Earth masses) was established late in the disk evolution stage, just before it was dispersed completely [1].

Rossby vortices

We have studied the 3-D Rossby vortices associated with the partial gap boundaries generated by the planets. These vortices were shown to be excited by our earlier work and it has now been confirmed by our 3-D studies and numerous other groups. We found that when the planet is massive enough, it carves out a deep gap around its orbit. Due to its significant density variations and the corresponding angular velocity adjustments, the gap edge can typically excite the Rossby wave instability. We have examined the long-term evolution of these vortices by carrying out high-resolution two-dimensional hydrodynamic simulations that last more than 10000 orbits as measured at the planet's orbit. This is shown in Figure 1. We find that the disk viscosity has a strong influence on both the emergence and lifetime of vortices. In the outer disk region where asymmetric features are observed, our simulation results suggest that the disk viscosity needs to be low in order to sustain vortices to thousands and up to 10000 orbits in certain cases [2]. These studies are quite timely because of the newly discovered vortex features in several protoplanetary disks by ALMA. Our results show that vortices excited by massive planets can be a good candidate for explaining such observations.

Dust Dynamics

We have performed many simulations to study the asymmetric dust distribution observed by ALMA and other telescopes. In particular, we have studied how the banana-shaped dust distribution can be formed via the interaction among dust, gas, and the planet. We have found the Rossby wave instability (RWI) is a robust mechanism to form banana-shaped gas blobs in a disk. Furthermore, we have investigated two mechanisms to generate the RWI. Both of them require relatively low viscosity. One mechanism is using large planets to induce the RWI around the planet. We use Saturn-, Jupiter-, and two-Jupiter-mass planet in our simulations. In 2D simulations, we clearly see the banana-shaped distribution of the gas and dust. The banana-

shaped density blob can be maintained for hundreds of orbits. In 3D simulations, however, we find that the evolution of RWI and banana-shaped density blobs are short-lived and quickly become ring-shaped distribution. In addition, we have performed simulations to study the RWI in a disk without planets. The RWI can be produced with an initial density bump. We study how the vortices are generated via RWI and how they are merged and combined into one big vortex. We also study the RWI dependence on the disk self-gravity. The RWI caused by the initial density bump is short-lived and quickly disappear due to migration or diffusion. To have a long-lived RWI vortex, we set up a disk with non-uniform disk viscosity, where a region of disk has very low viscosity, similar to the dead-zone configuration. Even without initial density bump, the non-uniform viscosity can produce a density bump near the low viscosity region in a few hundreds of orbits. With small perturbation, the RWI can be produced and vortices can be generated. We can see the banana-shaped density distribution generated and maintained for a long time.

A New Dynamic Instability

Our simulations of protoplanetary disks with both gaseous and dust components reveal that: 1) dust particles which are migrating inward towards the star can be trapped by gas vortices very efficiently; 2) when the surface density of the accumulated dust exceeds that of the gas surface density, a new dynamic instability is excited, as shown in Figure 2. This instability gradually dissipates the gas vortices, shortening its lifetime [3]. Interestingly, however, the much enhanced concentration of dust particles inside the vortex can lead to strong dust coagulation, a favorable condition for planetesimal formation. These studies are helping us to make direct comparisons between our simulations and the new observations. This allows us to constrain the disk properties and provides more detailed understanding on how the planet + disk interactions evolve in a dusty protoplanetary disks.

Impact on National Missions

Understanding the formation of exoplanets is one of the grand challenges for the coming decade in astronomy and astrophysics, as evidenced by the recent Decadal Survey (Astro2010): "New Worlds, New Horizons in Astronomy and Astrophysics" ("New Worlds" refers specifically to exoplanet research). The critical physics that underpins this field include high Reynolds number turbulence and shear flow instabilities, all of which match with LANL's strength, both in theory and large-scale computing. With the advent of ALMA and EVLA, LANL is making a critical impact now, building on our existing expertise in disk+planet computational studies.

In addition, this project has strengthened our ties with top universities and researchers in this thriving field, including UCSC, STSCI, VLA and Harvard. Several students and postdocs from these institutions have collaborated with us. Overall, we have published 10 papers in the refereed journals (with several more in preparation) and have given many invited talks at various conferences.

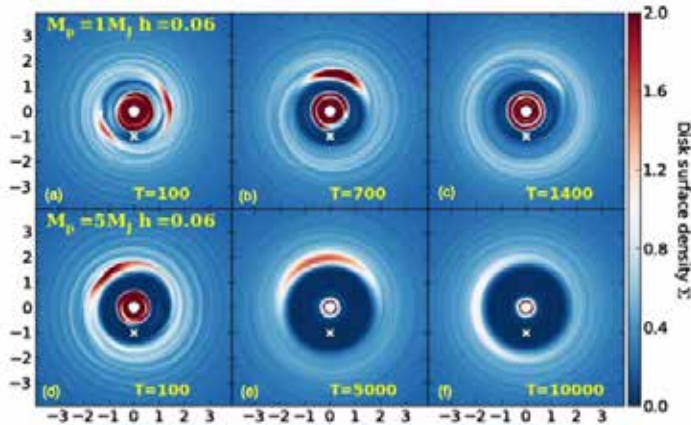

Figure 1. Evolution of disk surface density showing how the vortex develops and evolves for two different planet masses (top: 1 Jupiter mass; bottom: 5 Jupiter mass). Planet is marked by x and the star is located at the center. The planet gradually carves out a gap (dark blue regions) around its orbit. The edges of the gap then undergo Rossby wave instability, leading to the formation of large-scale vortices (as indicated by the density enhancement). Over long periods of time, these vortices gradually dissipate and disappear. The lifetime of these vortices is important to determine the observability of these features. Furthermore, their survival also has important implications for the dust accumulation. (Figure taken from Fu et al. 2014a).

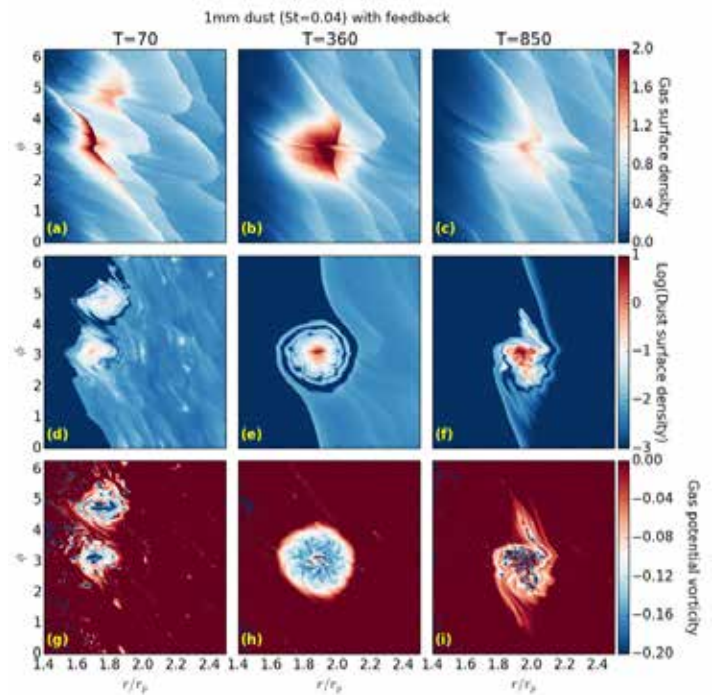

Figure 2. Evolution of gas surface density (top row), log of dust surface density (middle row) and gas potential vorticity (bottom row) in the $\{r, \phi\}$ plane. The star is to the left and the planet is placed at $r/r_p = 1$. While gas vortices are excited and finally merged into one large vortex (top row), this vortex also serves as an efficient dust trap that collects nearly all the dust that are migrating from larger radial distances towards the star (middle row). Dust accumulates so much that its surface density exceeds that of the gas component, leading to the excitation of a new dynamical instability (as indicated by the pinwheel features in the middle panel of the middle row). This instability eventually causes the destruction of gas vortex. The existence of these vortices and their role in accumulating large amount of dust could have important consequences for planetesimal formation.

References

1. Zhang, X., H. Li, S. Li, and D. Lin. RESONANCES OF MULTIPLE EXOPLANETS AND IMPLICATIONS FOR THEIR FORMATION . 2014. ApJ Letters. 789: 23 .
2. Fu, W., H. Li, S. Lubow, and S. Li. LONG-TERM EVOLUTION OF PLANET-INDUCED VORTICES IN PROTOPLANETARY DISKS. 2014. ApJ Letters. 788: 41.
3. Fu, W., H. Li, S. Lubow, and S. Li. Effects of dust feedback on vortices in protoplanetary disks. To appear in ApJ Letters.

Publications

Aluie, H., Shengtai Li, and Hui Li. Conservative Cascade of Kinetic Energy in Compressible Turbulence. 2012. Astrophysical Journal, Letters. 751 (2): L29 (6 pp.).

Collins, D., A. Kritsuk, P. Padoan, H. Li, H. Xu, S. Ustyugov,

-
- and M. Norman. THE TWO STATES OF STAR-FORMING CLOUDS. 2012. ASTROPHYSICAL JOURNAL. 750 (1): 13.
- Fu, W., H. Li, Lubow, and Li. LONG-TERM EVOLUTION OF PLANET-INDUCED VORTICES IN PROTOPLANETARY DISKS. 2014. ASTROPHYSICAL JOURNAL LETTERS. 788 (2).
- Fu, W., H. Li, S. Lubow, and S. Li. Effects of dust feedback on vortices in protoplanetary disks. To appear in ApJL.
- Johnson, J. L., and H. Li. Constraints on planet formation via gravitational instability across cosmic time. 2013. Monthly Notices of Royal Astronomical Society. 431: 972.
- Johnson, J., and H. Li. THE FIRST PLANETS: THE CRITICAL METALLICITY FOR PLANET FORMATION. 2012. ASTROPHYSICAL JOURNAL. 751 (2): 81.
- Li, H., and S. Li. 3D Simulations of Type-I Migration in Nearly Laminar Disks. 2013. European Physical Journal. 46: 05003.
- Liu, B., X. Zhang, D. Lin, and S. J. Aarseth. MIGRATION AND GROWTH OF PROTOPLANETARY EMBRYOS II: EMERGENCE OF PROTO-GAS-GIANTS'S CORES VERSUS SUPER-EARTHS' PROGENITOR. To appear in ApJ.
- Zhang, , H. Li, Li, and D. N. C. Lin. RESONANCES OF MULTIPLE EXOPLANETS AND IMPLICATIONS FOR THEIR FORMATION. 2014. ASTROPHYSICAL JOURNAL LETTERS. 789 (1).
- Zhang, X., B. Liu, D. Lin, and H. Li. Migration and Growth of Protoplanetary Embryos I: Convergence of Embryos in Protoplanetary Disks. To appear in ApJ.

Metabolic Engineering of an Algal Lipid Bioswitch

Chris M. Yeager
20120400ER

Abstract

The ability to control or monitor gene expression in algae, via an engineered bioswitch, would be a tremendous advance in the state of the science and aid in the development of engineered algal strains for large-scale biofuel production systems. The overall goal of this project was to develop a bioswitch/sensor for the unicellular model green algae, *Chlamydomonas reinhardtii*. Specifically, we aimed to engineer *C. reinhardtii* strains that were capable of sensing intracellular concentrations of fatty acids and responding through expression of a reporter gene. The *Escherichia coli* transcription factor FadR was characterized, modulated and inserted into *C. reinhardtii* as the fatty acid sensing module. It was determined that the FadR consensus operon is quite similar to the consensus operon of another transcriptional regulator, PdhR (a global transcriptional regulator that responds to pyruvate). Follow-up *in vivo* experiments indicated that these two transcriptional regulators can co-regulate gene expression from shared DNA binding sites. This is the first evidence that fatty acid metabolism and central metabolism are linked through the coordinated action of transcriptional regulators in *E. coli*. Amino acid mutations were identified in FadR that led to enhanced binding of the fatty acid effector molecule, palmitoyl-CoA, and other mutations that severely diminished binding of palmitoyl-CoA to the FadR/DNA operator complex. These results support our view that FadR and other transcriptional regulators with similar structural folds can be engineered to affect the binding of their effector molecules (in this case, long-chain length fatty acyl CoA molecules), making them suitable for engineering to create dynamic sensor-regulators systems for the biosynthesis of biofuels and commodity chemicals. Lastly, we describe the construction and evaluation of a FadR lipid biosensor in *Chlamydomonas reinhardtii*.

Background and Research Objectives

The ability to control or monitor gene expression in algae, via an engineered bioswitch, would be a tremen-

dous advance in the state of the science and aid in the development of engineered algal strains for large-scale biofuel production systems. Recent attempts to engineer biological systems for enhanced fatty acid production have highlighted that FadR, or similar transcriptional regulators, play a critical role in these endeavors [1, 2]. Indeed, FadR-directed research has been used to enhance production of fatty acids in *E. coli* [3] and to engineer a whole cell, dynamic sensor-regulator system that responds to fatty acyl-CoA concentrations [2]. Despite the intrinsic adaptability of wild type FadR for bioengineering purposes, tailoring and optimizing its regulatory characteristics (i.e. enhanced or decreased sensitivity to the effector molecules, fatty acyl-CoAs) will expand its use as a dynamic sensor-regulator system. For example, FadR variants with lower acyl-CoA binding affinities could be a useful component of a dynamic sensor-regulator system to trigger a response once a threshold concentration of free fatty acids is exceeded. In this project, we set out to develop a FadR-based bioswitch/sensor for the unicellular model microalga, *Chlamydomonas reinhardtii*.

The specific goals of this project were: 1) characterize the transcriptional regulator, FadR, in *Escherichia coli*, with an emphasis on its potential as a biosensor for fatty acid detection in algae, 2) use computational prediction tools to identify FadR variants that are expected to require higher concentrations of acyl-CoA to elicit DNA release, and 3) demonstrate a functional FadR-based biosensor that is operational in *C. reinhardtii*. During the first phase of the project, we discovered that the FadR regulon in *E. coli* consists of more genes/operons than has previously been reported. It was also discovered that the FadR consensus operon is quite similar to the consensus operon of another transcriptional regulator, PdhR (a global transcriptional regulator that responds to pyruvate). Follow-up *in vivo* evidence indicated that these two transcriptional regulators can co-regulate gene expression from shared DNA binding sites. This is the first evidence that fatty acid metabolism and

central metabolism are linked through the coordinated action of these transcriptional regulators in *E. coli*. For goal #2, we identified amino acid mutations in FadR that led to enhanced binding of the fatty acid effector molecule, palmitoyl-CoA, and other mutations that severely diminished binding of palmitoyl-CoA to the FadR/DNA operator complex. For goal #3, we genetically transformed reporter protein under the control of the FadO/ FadR regulatory system. The expression of the fluorescent reporter responded to increased lipid accumulation in *Chlamy* demonstrating a lipid-responsive biosensor.

Scientific Approach and Accomplishments

Goal 1: Characterization of the FadR regulon in *E. coli*. An improved consensus operator (DNA) binding sequence for FadR (ANTGGTCNGACCAG) was determined using a protein binding array. To date, there are twelve known binding sites (12 operons, 15 genes) of FadR, that regulate multiple genes involved in fatty acid synthesis and catabolism (*fab* and *fad* genes, respectively), the glyoxylate shunt of central metabolism (*iclR*), and a universal stress response regulator (*uspA*) [4]. Using the newly identified FadR binding motif, we searched the *E. coli* genome and identified a number of potential new FadR binding sites upstream of coding regions. Interestingly, 5 of the top 59 suspected FadR binding sites are known operator sequences for the pyruvate-responsive, transcriptional regulator, PdhR (Figure 1). Furthermore, the FadR operator consensus sequence that we identified using the protein binding array is quite similar to that of PdhR (ATTGGTAANACCAT) [4].

Results of in vitro and in vivo experiments indicate that FadR exhibits near maximal binding to the consensus FadR operon in *E. coli*. Additionally, we found that one half of the operator (it occurs as a palindrome) is sufficient for tight binding. Binding of FadR to known PdhR operator sequences in vitro was confirmed by gel shift assays, and binding was inhibited in the presence of fatty acyl-CoA molecules. Reverse transcriptase quantitative PCR assays were developed for four *E. coli* genes that we believed could be dually controlled by FadR and PdhR. Gene expression analysis revealed an inverse relationship between the effects of a *fadR* deletion versus a *pdhR* deletion on the expression of three of these genes (Figure 2). Overall, our results suggest that FadR and PdhR act conversely on gene expression at a number of loci in *E. coli* to coordinate fatty acid and central metabolic activities of the cell. A manuscript describing this work, Transcriptional Regulators Involved in Fatty Acid and Pyruvate Metabolism Recognize Nearly Identical Operator Sequences in *Escherichia coli*, will be submitted in 2014.

Accession #	GENE	E-VALUE	FadR regulon	PdhR regulon
YP_001731278	<i>fadI</i>	0.87	█	
YP_001730812	<i>yebV</i>	1.8	█	
YP_001729170	<i>fadE</i>	2.9	█	
YP_001730727	<i>yjgX</i>	3	█	
YP_001732644	<i>fadB</i>	4.3	█	
YP_001733089	<i>deoB</i>	4.4		█
YP_001729460	<i>ybcV</i>	4.6		█
YP_001731847	<i>gldD</i>	4.9		█
YP_001731465	<i>csiE</i>	6.9		█
YP_001729349	<i>fadM</i>	7.2	█	
YP_001732981	<i>yfjK</i>	8.8	█	
YP_001731380	<i>fadL</i>	9.5	█	
YP_001731612	<i>ascB</i>	12		█
YP_001732055	<i>lptB</i>	15		█
YP_001729189	<i>ykfI</i>	17		█
YP_001731600	<i>srIB</i>	17		█
YP_001732324	<i>pitA</i>	24		█
YP_001732178	<i>fusA</i>	27		█
YP_001732722	<i>clpQ</i>	29		█
YP_001731255	<i>usc</i>	32		█
YP_001730080	<i>ndh</i>	32		█
YP_001731803	<i>pgk</i>	33		█
YP_001730109	<i>yecX</i>	38		█
YP_001729392	<i>cueR</i>	39		█
YP_001730953	<i>yodB</i>	39		█
YP_001732476	<i>cpzA</i>	40		█
YP_001730191	<i>oppB</i>	43		█
YP_001729811	<i>gsiD</i>	46		█
YP_001730697	<i>thrS</i>	48		█
YP_001730202	<i>exo</i>	48		█
YP_001730123	<i>minD</i>	48		█
YP_001730654	<i>ydhY</i>	50		█
YP_001732070	<i>ybdD</i>	53		█
YP_001732413	<i>yaiT</i>	54		█
YP_001733064	<i>nanS</i>	58		█
YP_001733046	<i>fecR</i>	59		█
YP_001729686	<i>kdpF</i>	59		█
YP_001732163	<i>gspC</i>	61		█
YP_001729282	<i>yaiV</i>	61		█
YP_001730808	<i>mscC</i>	64		█
YP_001733082	<i>yjIA</i>	64		█
YP_001729895	<i>ycaR</i>	68		█
YP_001729221	<i>yagK</i>	68		█
YP_001732005	<i>yraN</i>	69		█
YP_001731054	<i>yehC</i>	77		█
YP_001729832	<i>ybjN</i>	78		█
YP_001731011	<i>wzh</i>	78		█
YP_001729994	<i>yadL</i>	81		█
YP_001729440	<i>ybcC</i>	82		█
YP_001729154	<i>metQ</i>	83		█
YP_001730799	<i>yobF</i>	85		█
YP_001731716	<i>lgt</i>	91		█
YP_001733075	<i>yjiZ</i>	93		█
YP_001732102	<i>ybdH</i>	96		█
YP_001729070	<i>pdhR</i>	96		█
YP_001730456	<i>narV</i>	98		█
YP_001729266	<i>frmB</i>	98		█
YP_001729337	<i>cyoB</i>	99		█
YP_001732047	<i>mlaD</i>	100		█

Figure 1. *FadR* motif search of the genome using the Motif Alignment and Search Tool [5]. Sequences with an E-value score are reported. Genes known to be in the FadR or PdhR regulon are indicated.

Goal 2: Construction and analysis of FadR variants. The computational efforts, which were led by Ramesh Jha and Charlie Strauss, have achieved two primary goals. First, we have identified several mutations that have the potential to reduce the affinity of FadR for fatty acyl-CoAs. With a FadR mutant exhibiting reduced affinity for fatty acyl-CoAs in hand, we hope to develop a FadR-controlled switch that only responds when cell lipid concentrations are high. Using the crystal structure of FadR bound to myristate (C14 fatty acid) as a guide, we demonstrated that the community modeling software, Rosetta, could accurately predict the ligand-protein conformation. We then identified two promising mutations, L102A and L165N, that were predicted to result in weakened interactions between FadR and fatty acyl-CoAs, without disrupting the overall structure of the protein or interfering with the communication between the inducer binding pocket and DNA binding domain of FadR. Thus, mutants at the L102/L165 positions were constructed with the purpose of expanding the binding pocket of the lipid ligand to accommodate longer lipids. It was also determined that the A213 of FadR should be directly involved in the binding of the CoA moiety of fatty acids; we included mutations at this position in an attempt to decrease FadR's affinity for the CoA moiety of the ligand.

Accession #	GENE	E-VALUE	FadR regulon	PdhR regulon
YP_001731278	fadI	0.87		
YP_001730812	yehV	1.8		
YP_001729170	fadE	2.9		
YP_001730727	yjyX	3		
YP_001732644	fadB	4.3		
YP_001733089	deoB	4.4		
YP_001729460	ybcV	4.6		
YP_001731847	gldD	4.9		
YP_001731465	csiE	6.9		
YP_001729549	fadm	7.2		
YP_00172981	yfK	8.8		
YP_001731280	fadL	9.5		
YP_001731612	ascB	12		
YP_001732055	lptB	15		
YP_001729189	ykfI	17		
YP_001731600	strB	17		
YP_001732324	pitA	24		
YP_001732178	flaA	27		
YP_001732722	clpQ	29		
YP_001731255	usg	32		
YP_001730080	ndh	32		
YP_001731803	pgk	33		
YP_001730109	yegX	38		
YP_001729392	cueR	39		
YP_001730933	yodB	39		
YP_001732476	tpoZ	40		
YP_001730191	oppB	43		
YP_001729811	gstD	46		
YP_001730697	thrS	48		
YP_001730202	exo	48		
YP_001730123	minD	48		
YP_001730654	ydhY	50		
YP_001732070	yhdD	53		
YP_001732413	yiaT	54		
YP_001733064	nanS	58		
YP_001733046	fecR	59		
YP_001729686	kdpF	59		
YP_001732163	gspC	61		
YP_001729282	yaiV	61		
YP_001730808	mstC	64		
YP_001733082	yjyA	64		
YP_001729895	ycaR	68		
YP_001729221	yagK	68		
YP_001732005	yraN	69		
YP_001731054	yehC	77		
YP_001729832	yjyN	78		
YP_001731011	wb	78		
YP_001729094	yadL	81		
YP_001729440	ybcC	82		
YP_001729154	metQ	83		
YP_001730799	yobF	85		
YP_001731716	lgt	91		
YP_001733075	yjyZ	93		
YP_001732102	yjyH	96		
YP_001729070	pdhR	96		
YP_001730456	narV	98		
YP_001729266	frmB	98		
YP_001729337	eyoB	99		
YP_001732047	miaD	100		

Figure 2. Relative expression of genes known to belong to the FadR () and PdhR () regulons in *C. reinhardtii* cells grown on galactose (A, B) or glycerol (C, D). Gene expression was normalized against expression of (A, C) or (B, D). Blue bars represent gene expression in deletion mutants versus wild type and red bars show gene expression in deletion mutants versus wild type. Bars represent the average of three biological replicates.

Led by Ricardo Marti-Arbona (an early career LANL staff member), we developed and optimized an experimental assay applying fluorescence anisotropy to measure the binding constant of FadR (wild type and variants) for its palmitoyl-CoA ligand and DNA operator sequence (FadO). Under the experimental conditions we obtained a Kd value of 2 nM of FadR at 1 nM labeled-FadO and 600 nM for the palmitoyl-CoA ligand at 10 nM of FadR at 1 nM labeled-FadO. The mutant protein containing the R213A mutation was purified and exhibited drastically decreased binding for palmitoyl-CoA ligand (Kd >5 μM; wild type 600 nM). In contrast, the L102A mutant protein exhibited increased affinity for palmitoyl-CoA (Kd 390 nM) (Figure 3). Some of the FadR mutant proteins have proven exceedingly difficult to purify (e.g. the R213M protein was not stable following purification). Mutations that replaced the arginine at position 213 dramatically affected the binding of palmitoyl-CoA, presumably by eliminating the guanidine positive charge necessary to bind the di-phosphate moiety of the acyl-CoA effectors. Also the mutation of the leucine at position 102 enhanced the binding of the palmitoyl-CoA

Accession #	GENE	E-VALUE	FadR regulon	PdhR regulon
YP_001731278	fadI	0.87		
YP_001730812	yehV	1.8		
YP_001729170	fadE	2.9		
YP_001730727	yjyX	3		
YP_001732644	fadB	4.3		
YP_001733089	deoB	4.4		
YP_001729460	ybcV	4.6		
YP_001731847	gldD	4.9		
YP_001731465	csiE	6.9		
YP_001729549	fadm	7.2		
YP_00172981	yfK	8.8		
YP_001731280	fadL	9.5		
YP_001731612	ascB	12		
YP_001732055	lptB	15		
YP_001729189	ykfI	17		
YP_001731600	strB	17		
YP_001732324	pitA	24		
YP_001732178	flaA	27		
YP_001732722	clpQ	29		
YP_001731255	usg	32		
YP_001730080	ndh	32		
YP_001731803	pgk	33		
YP_001730109	yegX	38		
YP_001729392	cueR	39		
YP_001730933	yodB	39		
YP_001732476	tpoZ	40		
YP_001730191	oppB	43		
YP_001729811	gstD	46		
YP_001730697	thrS	48		
YP_001730202	exo	48		
YP_001730123	minD	48		
YP_001730654	ydhY	50		
YP_001732070	yhdD	53		
YP_001732413	yiaT	54		
YP_001733064	nanS	58		
YP_001733046	fecR	59		
YP_001729686	kdpF	59		
YP_001732163	gspC	61		
YP_001729282	yaiV	61		
YP_001730808	mstC	64		
YP_001733082	yjyA	64		
YP_001729895	ycaR	68		
YP_001729221	yagK	68		
YP_001732005	yraN	69		
YP_001731054	yehC	77		
YP_001729832	yjyN	78		
YP_001731011	wb	78		
YP_001729094	yadL	81		
YP_001729440	ybcC	82		
YP_001729154	metQ	83		
YP_001730799	yobF	85		
YP_001731716	lgt	91		
YP_001733075	yjyZ	93		
YP_001732102	yjyH	96		
YP_001729070	pdhR	96		
YP_001730456	narV	98		
YP_001729266	frmB	98		
YP_001729337	eyoB	99		
YP_001732047	miaD	100		

Figure 3. Determination of (A) FadO Kd (DNA binding) and (B) Palmitoyl-CoA Kd values for wild type (WT) and FadR mutants. WT is represented by black circles, L102A by red diamonds, R213A by green squares and R213M by dark green triangles.

effector, seemingly by expanding the size of the binding pocket and facilitating the binding of the effectors' hydrocarbon side chain. These findings suggest that fatty acid metabolism regulator (FadR) and other TRs with similar structural fold can be engineered to affect the binding of their effector molecules and therefore control the release of the DNA operators, making them suitable for engineering to create dynamic sensor-regulators systems for the biosynthesis of biofuels and commodity chemicals. A portion of this research was presented by Ramesh Jha at LANL Postdoc Research Day, June 2012 (the poster won Honorable Mention). Ramesh Jha has since been converted to a LANL staff member in the Bioscience Division. A manuscript describing this work, Rational Design and In-vitro Characterization of Alterations to the Lipid Recognition Site of the Lipid Metabolism Transcriptional Regulator, will be submitted to Protein Science in October 2014.

Goal 3: Establish a functional fluorescent-based/lipid-responsive biosensor in *C. reinhardtii*. The effort to incorporate the FadR-based biosensor components into *C. reinhardtii* was led by Scott Twary and Ricardo Marti-Arbona. Our functional lipid-based biosensor will utilize a fluorescent marker to report when the lipid levels in *C. reinhardtii*

Accession #	GENE	E-VALUE	FadR regulon	PdhR regulon
YP_001731278	fadI	0.87		
YP_001730812	yebV	1.8		
YP_001729170	fadE	2.9		
YP_001730727	ydjX	3		
YP_001732644	fadB	4.3		
YP_001733089	deoB	4.4		
YP_001729460	ybcV	4.6		
YP_001731847	gldD	4.9		
YP_001731465	csiE	6.9		
YP_001729349	fadM	7.2		
YP_001732981	ytkK	8.8		
YP_001731280	fadL	9.5		
YP_001731612	ascB	12		
YP_001732055	lptB	15		
YP_001729189	ykfI	17		
YP_001731600	stfB	17		
YP_001732324	pitA	24		
YP_001732178	fusA	27		
YP_001732722	clpQ	29		
YP_001731255	usg	32		
YP_001730680	ndh	32		
YP_001731803	pgk	33		
YP_001730109	yegX	38		
YP_001729592	cueR	39		
YP_001730933	yodB	39		
YP_001730123	rpoZ	40		
YP_001730191	oppB	43		
YP_001729811	gsiD	46		
YP_001730697	thrS	48		
YP_001730202	exo	48		
YP_001730123	minD	48		
YP_001730654	ydbY	50		
YP_001732070	yhcD	53		
YP_001732413	yiaT	54		
YP_001733064	nanS	58		
YP_001733046	fecR	59		
YP_001729686	kdpF	59		
YP_001732163	gspC	61		
YP_001729282	yaiV	61		
YP_001730808	mecC	64		
YP_001733082	yjiA	64		
YP_001729895	ycarR	68		
YP_001729221	yagK	68		
YP_001732005	yraN	69		
YP_001731054	yhcC	77		
YP_001729832	yjhN	78		
YP_001731011	wzb	78		
YP_001729094	yadL	81		
YP_001729440	ybcC	82		
YP_001729154	metQ	83		
YP_001730799	yobF	85		
YP_001731716	lgt	91		
YP_001733075	yjiZ	93		
YP_001732102	yhdH	96		
YP_001729070	pdhR	96		
YP_001730456	narV	98		
YP_001729266	frmB	98		
YP_001729337	cyoB	99		
YP_001732047	miaD	100		

Figure 4. A) Wild type B) + Construct 1. C) + Construct 2. The image on the left (for each set in A, B, and C) is using white light to observe the whole cell. The middle image uses fluorescent excitation of chlorophyll A to locate the chloroplast. The right image specifically excites the green fluorescent protein inserted as a reporter for the FadO constructs. These images show the directed expression of the GFP in the chloroplast.

raises over a certain threshold. To achieve this we are taking advantage of the ability of the transcriptional regulator FadR to control expression of genes downstream from the DNA regulatory sequence FadO. We placed the fluorescent reporter under the control of a constitutive promoter, which at the same time will be under control of the FadR module. There are two primary steps to be completed in order to obtain a functional lipid-based biosensor. First, the biosensor reporter needs to be incorporated into the chloroplast genome under dual control. The first control will be a constitutive promoter that will allow the continuous expression of the reporter (in this case a green fluorescent protein: GFP); the second control point will be a FadR binding site. In the second step, the FadR regulator needs to be incorporated into the chloroplast genome under the control of a constitutive promoter. In order to achieve these goals two successful chloroplast transformations and genomic incorporations were needed, one for the reporter and one for the regulator.

To accomplish the first goal (reporter incorporation) we utilized a chloroplast specific plasmid called pSE 3HB Kan D2 gfp D1, which was kindly provided by Dr. Stephen May

Accession #	GENE	E-VALUE	FadR regulon	PdhR regulon
YP_001731278	fadI	0.87		
YP_001730812	yebV	1.8		
YP_001729170	fadE	2.9		
YP_001730727	ydjX	3		
YP_001732644	fadB	4.3		
YP_001733089	deoB	4.4		
YP_001729460	ybcV	4.6		
YP_001731847	gldD	4.9		
YP_001731465	csiE	6.9		
YP_001729349	fadM	7.2		
YP_001732981	ytkK	8.8		
YP_001731280	fadL	9.5		
YP_001731612	ascB	12		
YP_001732055	lptB	15		
YP_001729189	ykfI	17		
YP_001731600	stfB	17		
YP_001732324	pitA	24		
YP_001732178	fusA	27		
YP_001732722	clpQ	29		
YP_001731255	usg	32		
YP_001730680	ndh	32		
YP_001731803	pgk	33		
YP_001730109	yegX	38		
YP_001729592	cueR	39		
YP_001730933	yodB	39		
YP_001730123	rpoZ	40		
YP_001730191	oppB	43		
YP_001729811	gsiD	46		
YP_001730697	thrS	48		
YP_001730202	exo	48		
YP_001730123	minD	48		
YP_001730654	ydbY	50		
YP_001732070	yhcD	53		
YP_001732413	yiaT	54		
YP_001733064	nanS	58		
YP_001733046	fecR	59		
YP_001729686	kdpF	59		
YP_001732163	gspC	61		
YP_001729282	yaiV	61		
YP_001730808	mecC	64		
YP_001733082	yjiA	64		
YP_001729895	ycarR	68		
YP_001729221	yagK	68		
YP_001732005	yraN	69		
YP_001731054	yhcC	77		
YP_001729832	yjhN	78		
YP_001731011	wzb	78		
YP_001729094	yadL	81		
YP_001729440	ybcC	82		
YP_001729154	metQ	83		
YP_001730799	yobF	85		
YP_001731716	lgt	91		
YP_001733075	yjiZ	93		
YP_001732102	yhdH	96		
YP_001729070	pdhR	96		
YP_001730456	narV	98		
YP_001729266	frmB	98		
YP_001729337	cyoB	99		
YP_001732047	miaD	100		

Figure 5. Two clones containing the FadR lipid-responsive regulatory insertion show an increase in GFP fluorescent signal during nitrogen depletion growth and induced lipid accumulation.

field from the University of California at San Diego. This chloroplast vector utilizes the psbD promoter to control the expression of the green fluorescent protein (GFP) reporter. In order to obtain the dual control, we need place the FadO operator sequence within the psbD promoter, without disrupting its constitutive promoter function. We created four variants of the psbD promoter by introducing the 17 bp FadO operator sequence at key positions. We obtained successful transformation and reporter incorporation for the 4 constructs as confirmed by PCR experiments. Nevertheless, only two of the constructs yielded stable and constitutive expression of the GFP reporter. The results indicate that addition of the FadO sequence around the TATAATAT site of the promoter did not affect the function of the psbD promoter while the addition of the FadO sequence around the 3' side of the -10 PRB1 and the 5' side of the -40 PRB2 sites of the promoter disrupted its function. Figure 4 shows three panels for each of our working GFP reporter constructs, the first panel is the white light image for the cells, the second panel shows the fluorescent excitation (red) of chlorophyll A to locate the chloroplast and the third panel shows the engineered GFP (green) emission. These results confirm that the GFP reporter protein has been introduced into the chloroplast

genome of *C. reinhardtii*; it is expressed constitutively and is localized to the chloroplast.

To accomplish the second goal (FadR regulator incorporation) and to complete the biosensor we utilized a chloroplast specific plasmid, pLM20, which was kindly provided by Dr. Michel P. Goldschmidt-Clermont from Université de Genève, Switzerland. The pLM20 plasmid incorporated the FadR regulator gene - under the control of the *atpA* constitutive promoter - into the *C. reinhardtii* chloroplast genome that was previously modified by the incorporation of the GFP reporter. Successful transformations yielded the incorporation of active FadR. When active FadR is expressed in the chloroplast of the GFP-*C. reinhardtii* (FadR-GFP-*C. reinhardtii*), it binds to the FadO regulatory sequence and down-regulates the expression of the GFP marker under low lipid conditions. As explained above, FadR binds to FadO in the absence of acyl-CoA lipids, therefore it is hypothesized that expression of the GFP reporter would be blocked by FadR until the concentration of lipids in the chloroplast surpassed a certain threshold. Like other lipid producing strains of algae, *C. reinhardtii* is capable of producing and accumulating lipids under nitrogen starvation conditions. To test the functionality of our lipid-based biosensor, we performed an experiment in which the FadR-GFP(FadO)-*C. reinhardtii* mutant was grown in nitrogen rich medium. Algae growth depleted the nitrogen concentration in the medium triggering lipid accumulation. As the nitrogen concentration dropped, the FadR-GFP-*C. reinhardtii* mutant started producing and storing lipids. Figure 5 shows the normalized increase of fluorescence over time as the biosensor is activated by the increase in lipid concentration. The increased GFP fluorescence over time (1.5 fold) reflects the activity of the engineered lipid responsive bioswitch. These results confirm that the biosensor is capable of recognizing increased chloroplast lipid concentrations and that after three days maximal response was achieved. A portion of this research was presented as a poster, "Development of a Fatty Acid Inducible Algal Bioswitch", at the 4th International Conference on Algal Biomass, Biofuels and Bioproducts in Santa Fe, NM, June 2014.

Impact on National Missions

The project builds LANL capability in engineering cellular factories and specifically aims to reduce the cost of biofuel production by simplifying oil extraction. Proof-of principle demonstration in this project has positioned us to acquire external funding from the biofuels industry, from DOE EERE, or the DoD for further optimization, expansion, and potentially commercialization of our concept. Two LANL postdoctoral students involved in this project, Tuhin Maity and Ramesh Jha, leveraged experience gained through this

work to obtain full time employment. Dr. Jha was converted to a LANL staff member and Dr. Maity accepted an algal biofuels R&D position in industry.

References

1. Salgado, H., M. Peralta-Gil, S. Gama-Castro, A. Santos-Zavaleta, and J. Callodo-Vides. RegulonDB v8. 0: omics data sets, evolutionary conservation, regulatory phrases, cross-validated gold standards and more.
2. Zhang, F., M. Ouellet, T. S. Bath, P. D. Adams, C. J. Petzold, A. Mukhopadhyay, and J. D. Keasling. Enhancing fatty acid production by the expression of the regulatory transcription factor FadR. 2012. *Metabolic engineering*. 14 (6): 653.
3. Zhang, F., J. M. Carothers, and J. D. Keasling. Design of a dynamic sensor-regulator system for production of chemicals and fuels derived from fatty acids. 2012. *Nature biotechnology*. 30 (4): 354.
4. LiCata, V. J., and A. J. Wowor. Applications of fluorescence anisotropy to the study of protein-DNA interactions. 2008. *Methods in Cell Biology*. 84: 243.
5. Bailey, T. L., M. Boden, F. A. Buske, M. Frith, C. E. Grant, L. Clementi, J. Ren, W. W. Li, and W. S. Noble. MEME Suite: tools for motif discovery and searching. 2009. *Nucleic Acids Research*. 37 (suppl 2): 1.

Publications

Marti-Arbona, R., S. N. Twary, R. K. Jha, and C. M. Yeager. Development of a fatty acid inducible algal bioswitch. Invited presentation at 4th International Conference on Algal Biomass, Biofuels and Bioproducts . (Santa Fe, 15-18 June, 2014).

A New Class of Antibody-like Molecules that Signal Upon Binding

Geoffrey S. Waldo
20120449ER

Abstract

Antibodies are used in every biology lab for binding target molecules. For detection, antibodies need labels (such as a fluorescent molecule), so the excess labeled antibody must be washed away to see just the antibody that bound. Biology needs antibody-like binders that give a signal only when bound to the target.

Our two-piece split green fluorescent protein (GFP) acts like a signaling anti-body/antigen pair. One 15 amino acid piece of the GFP acts as an antigen (piece of a target molecule), and it is bound by the remainder of the GFP 'detector' to become fluorescent GFP (acts like a signaling antibody). But this GFP detector only recognizes itself. We trained GFP to recognize pieces of other proteins. This involved making a library of GFP mutants, each made in a different cell, changing the amino acids on the area of the GFP that binds the new protein, and looking for mutants that turned fluorescent with the new protein.

We were the first to: (1) apply Rosetta in silico design to GFP containing its chromophore; (2) show this model could predict the stability of different GFP mutants; (3) experimentally generate hundreds of mutations at the interface of the detector GFP and the peptide it binds, and correlated the stability of these with in silico Rosetta predictions; (4) engineer a GFP detector that recognizes a peptide containing the most challenging sequence of a pathogenic protein from *M. tb* CFP-10, involved in virulence and early infection; (5) discover photoswitching mutants of a thermostable fluorescent protein that could lead to signaling antibodies whose binding is controlled by light.

We showed that novel fluorescent proteins can act as signaling antibodies. This will transform high-throughput/high-content biological assays in living cells. The likelihood of follow on funding for this cutting-edge project is high: NIH has a strong interest in antibodies for

live cell biology, and DTRA and DHS need stable assays for specific biological agents.

Background and Research Objectives

Modern biology needs tools to specifically label target proteins in living cells so that their movements and activities can be watched and better understood. Our long-term objective is to make a new class of antibody-like proteins based on fluorescent proteins that become fluorescent when they bind to a specific peptide or protein surface. Unlike conventional antibodies, these reagents would be straightforward to make, and would be expressed functionally in living cells. They would give a signal only when they bound their intended target. Long-term objectives include (1) making signaling antibodies that recognize linear epitopes by structural complementation with a peptide sequence, restoring folding and creating fluorescence; (2) making signaling antibodies that bind to surfaces of folded proteins, restoring fluorescence by shielding the chromophore of the fluorescent protein.

Conventional antibodies and single chains cannot be functionally expressed in living cells. Cells must be permeabilized for antibodies to get in from outside, preventing many types of experiments. Once introduced, they give a signal whether they bind their target or not, requiring removal of unbound labeled antibody. We propose two new classes of antibody mimics that signal with fluorescence when they recognize their target. One class is well suited for linear epitopes, including the intrinsically disordered regions recently recognized to occur in up to 40% of all eukaryotes. The second class is best suited for binding patches on folded proteins. Key advantages are that they can readily be expressed in situ and signal only when they recognize their targets. Furthermore, the sequence of the linear epitope can be used to guide the in silico design of specific binders. If successful, these signaling binders should revolutionize antibody technology, enable countless new applications

in living cells, such as monitoring intrinsically disordered proteins, high-content high-throughput assays, and new modes of target detection.

How our project goes beyond existing and competing work: Our work is distinct from fluorobodies, fluorescent proteins displaying binding loops in turns of the scaffold. Work continues at LANL and elsewhere to make these sufficiently robust to tolerate diverse loops. It is not immediately obvious how to make the fluorescence dependent on binding. Our new signaling antibodies omit a peptide strand of GFP, and then remodel the inter-face to recognize a new linear epitope. Binding results in fluorescence by restoring folding. The challenge here is to remodel the inter-face to specifically recognize and fold with a new peptide in lieu of the original native strand. This is also very different (and more challenging) than our on-going work with split GFPs, which has been focused on optimizing the solubility and stability of the native split fragments, increasing the repertoire of known split protein scaffolds from different species, and using them for protein detection and protein interactions. Work elsewhere using our split protein mutants, has mostly been of a confirmatory nature, further demonstrating the remarkable folding robustness of our split GFP system. Other GFP biosensor work has been focused on allosteric detectors incorporating a binding protein into a structurally sensitive region of the GFP scaffold. Examples include GFPs incorporating anti-beta lactamase binding protein and metal binding sites, and the like. To be useful, the signaling binders need to be generalizable, specific, and have a very high on/off ratio. Most of these allosteric reporters show very modest changes in absolute signal (a factor of 2) going from unbound to fully bound state. But our split GFP shows a > million-fold increase in fluorescence on peptide binding. Our new reporters based on custom structural complementation would be expected to have a similarly impressive dynamic range. Our GFP reagents are in use in hundreds of labs. If we succeed in making the antibody mimics proposed here, they would have an even greater impact on cell biology.

Key Objectives identified during the course of this project that were required to achieve the maximum of the long-term goals include: (1) devising a reliable in silico model (Rosetta program) of the stability of various GFP mutants (needed to help guide evolution of the new detector GFP). Previously no one had figured out how to incorporate the chromophore (the part of the GFP in the center of the 11-stranded barrel that actually fluoresces); (2) Validate the new Rosetta model by testing its ability to in-silico rank the stability of a set of several different GFP mutants of known experimental stability. This was needed to ensure the model could guide evolution by accurately suggesting

stabilizing mutations; (3) Use the model to evaluate the stability of a comprehensive set of mutations of known stability of the existing small peptide of GFP. This would be a further test to see how well the in-silico model would perform to guide evolution of the existing strand into the sequence of the new protein target; (4) gradually morph the GFP S11 strand to match the sequence of a disordered region of CFP-10 from *M. tb.* all the while mutating the GFP 1-10 detector to 'catch up' and recognize the new sequence. This would establish the feasibility of finding GFP based signaling antibodies against real targets of interest, in this case, a pathogen protein involved in virulence and TB infection; (5) Discover mutations of thermal green protein that could lead to efficient light-activated dissociation association of the GFP detector strand (signaling antibody) and the target protein (antigen). This could lead to tools to control detection and neutralization of proteins using light.

Scientific Approach and Accomplishments

Our robust protein tagging and detection system is based on the 11 beta-strand GFP scaffold. The 15 amino acid strand 11 (S11) tags proteins, GFP beta strands 1 to 10 (GFP 1-10) serve as a detector. Neither fragment alone is fluorescent but recombine to generate fluorescence. Features pertinent to Goal 1: (1) The S11 acts like an epitope tag, and the GFP 1-10 acts as an antibody; (2) unlike existing antibodies it lights up only when it binds its epitope tag; (3) importantly the GFP 1-10 detects its epitope target (S11) in living bacteria and eukaryotes. We used GFP 1-10 as a signaling antibody in a parallel study vs. conventional antibodies in cell applications, where it increased the signal-to-noise in flow cytometry sorts up to 100-fold, due to the fact that the unbound GFP 1-10 is non-fluorescent. The greatest challenge remains: the specific S11 'epitope tag' needs to be attached to proteins. What is needed is a new kind of GFP 1-10 that can detect any peptide, not just the original S11 strand. Then we could go after a large fraction of the numerous linear epitopes already known from conventional antibody work as well as the challenging class of intrinsically disordered proteins. The extended disordered regions should be rich in accessible linear epitopes, and our ability to predict these regions in proteins has dramatically improved in the last few years further increasing the impact of the proposed research.

Rosetta Prediction of Stability of Known Fluorescent Protein Mutants

We evolved several versions of a fluorescent protein from *Corynactis California* GFP, by selecting for stable fragment reassembly. These had varying stabilities, including some that were exceptionally stable to chemical denaturation (Figure 1, right). Since no one had ever used Rosetta to estimate fluorescent protein stability, we had to devise an

approach to include the chromophore of the GFP inside the barrel (numerous combinations of constraining it on its ends, allowing some relaxation). Once we devised a good approach we tested Rosetta's ability to rank the stability of the *Corynactis California* GFPs. Excellent agreement was observed (Figure 1, left)

Rosetta Prediction of Stability of Interaction between GFP 1-10 and mutants of S11

GFP1-10 was treated as a protein and S11 was treated as a peptide. Several approaches were tried, in the most successful method; the energy function had a damped repulsion term. This "soft repulsion" has been successful in capturing the effects of bulky substitutions in monomeric proteins, by allowing for low penalty upon atomic clashes, which otherwise are actually relieved in proteins by subtle perturbations in the backbone. 3 rounds of packing and minimization of the interface residues for GFP1-10 and S11 gave baseline binding energy for GFP 1-10/native S11. Binding energy was calculated by subtracting the energy score of repacked GFP 1-10 and S11, placed 1000 Å from the energy score of the complex modeled. Each residue of S11 was mutated to one of the 20 amino acids, and we calculate the binding energy for GFP 1-10/mutant S11. We calculated the difference in binding energy of GFP 1-10/native S11 and GFP 1-10/mutant S11 (Figure 2, left side). Experimental results were obtained by constructing all 20 possible mutations at each of the 16 positions of S11 and expressing in *E. coli* containing GFP 1-10. Higher fluorescence was considered to indicate greater stability (recognition of the S11 mutant by GFP 1-10) (Figure 2, right side). Results: Overall, for outer pointing residues such as D216, V219, H221, Y223 and N225: binding energy predicted for single point mutations by Rosetta is quite consistent with experimental results. For outer residues: H217, A227 binding energies predicted by Rosetta is slightly different from experimental results due to flexibility at the ends of the peptide in Rosetta model (Figure 2).

High-profile target

CFP-10 C-terminal disordered tail is essential for the secretion of the ESAT-6/CFP-10 heterodimer complex by the ESX-1 secretion system (aka the RD1 region). *M. tb* uses this ESX-1 secretion system to deliver virulence factors into host macrophage and monocyte white blood cells during infection (Figure 3, left side). Our Goal: develop GFP1-10 to recognize the C-terminal disordered tail of *M. tb* CFP-10 and turn on fluorescence with goal of eventually using it to inhibit the secretion of ESAT-6/CFP-10 complex and to detect the presence of this complex in *M. tb* infected patients. Process: Referring to Figure 4, the sequence of S11 is replaced with a 1 or a few amino acids of CFP-10, and then GFP 1-10 was mutated to catch up. 35 libraries

of all possible single point mutations on GFP 1-10 within 5 Å of GFP S11 were constructed and recombined onto a single GFP 1-10 scaffold. Each mutant had approximately 2-3 changes. Several rounds were performed, and then another mutation was made on S11 to make it an ever-closer match to CFP 1-10. Key residues of GFP most sensitive to mutation (see Figure 2) were targeted first. Results: A new GFP 1-10 that recognizes a new S11 in which key residues have been changed to match CFP-10. Referring to Figure 3, right side, the original GFP 1-10 does not recognize the new S11. The new GFP 1-10, carrying up to 15 new mutations, recognizes the new S11.

Photoswitching mutants of thermotolerant green fluorescent protein (TGP)

During the course of this project we included additional scaffolds with superstability as potential candidates for ultra-robust fluorescent signaling antibodies. During the course of this work Patricia Langan and co-workers discovered new mutants of TGP previously developed in Andrew Bradbury's lab, that could be switched repeatedly between strongly and weakly absorbing states, or strongly and weakly fluorescent states (Figure 5). The significance is, that this is expected to be associated with cis/trans or protonation/deprotonation of the chromophore: accompanied by a change in stability. We expect to be able to extend the results of this project to include signaling antibodies whose binding can be turned on and off with light.

Impact on National Missions

By providing new in vivo detection reagents with 'zero-background' and ease of production, and a means to engineer them, we will position LANL to be competitive in gaining funding for two major future mission areas, the first in the specific detection and monitoring of protein targets in living cells, and the second the detection and analysis of protein trafficking and expression during physiological processes including baselines and responses to environmental factors or disease states including biothreats or cancer. We would define a new class of detection reagents, more generally the concept of 'completeins', or 'signaling antibodies' generated by perturbation co-evolution. We plan to carry this work to the next level in our recently submitted NIH R01.

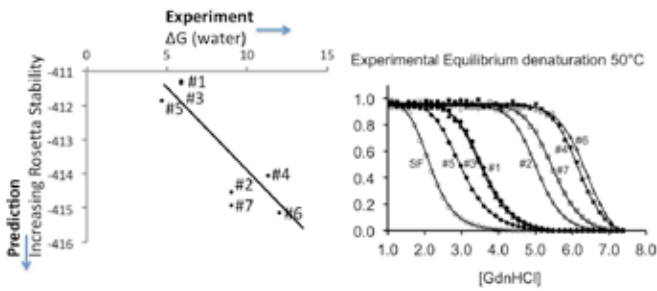

Figure 1. Rosetta predicted stability of mutants of *Corynactis californica* fluorescent protein (y axis) vs. experimental stability derived from chemical unfolding profiles (x axis) (left panel). Chemical unfolding profiles of the stability mutants (right panel).

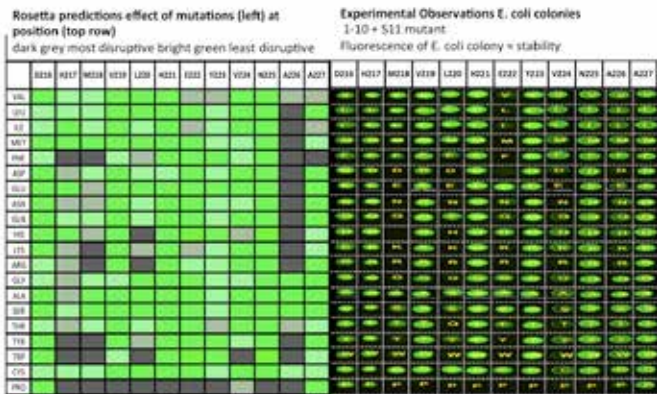

Figure 2. Effect of single point mutations of strand 11 (S11) on stability of GFP 1-10 + S11 complex. All possible mutations were made (rows) at each of the positions of S11 (columns). Left panel shows Rosetta stability, color coded black (very detrimental) to bright green (very stable). Right panel shows experimental complementation of *E. coli* colonies corresponding to each mutant/

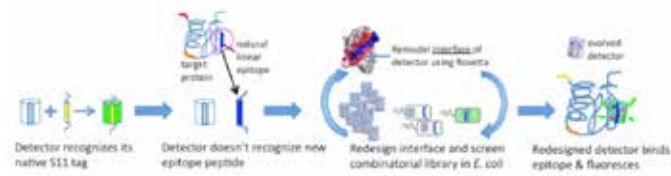

Figure 3. Schema for engineering new versions of the GFP 1-10 strand that recognize disordered regions of proteins.

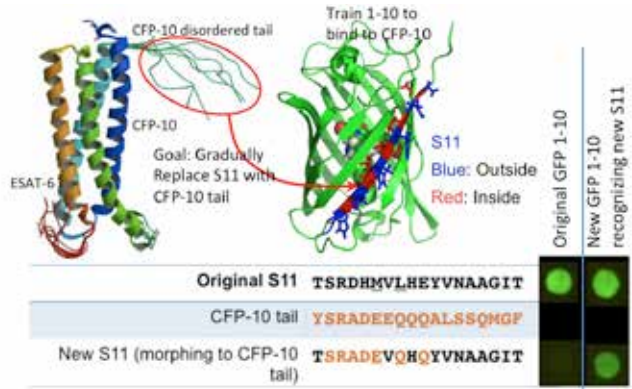

Figure 4. CFP-10 from (left) is used to guide the replacement of amino acids in S11 one-by-one (right). The new GFP 1-10 recognizes the S11 containing CFP-10.

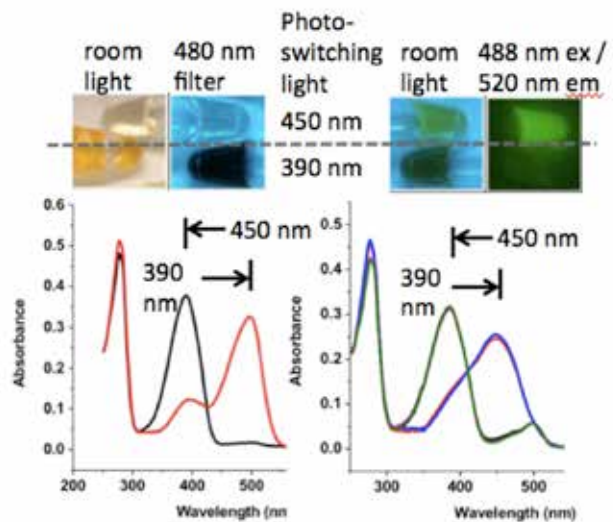

Figure 5. Photoactivated mutants of thermal green protein (TGP). Left panel, photochromic shifter, right panel, fluorescent photoactivated protein. These can serve as templates for making signaling antibodies that can be activated to bind a protein using light.

Publications

Cabantous, S., H. B. Nguyen, J. D. Pedelacq, F. Koraichi, A. Chaudhary, K. Ganguly, M. A. Lockard, G. Favre, T. C. Terwilliger, and G. S. Waldo. A New Protein-Protein Interaction Sensor Based on Tripartite Split-GFP Association. 2013. Scientific Reports. : 1.

Energy Efficient, Inducible Harvesting of Microalgae for Biofuels Production

Richard T. Sayre
20120535ER

Abstract

In the production of microalgal biofuels, an effective harvesting strategy that results in high biomass yields at low energy costs has yet to be optimized. Currently, microalgal pond biomass represents only ~0.1% of pond volume, and harvesting strategies relying on water removal have high fuel and energy costs. The small particle size and cell density of microalgae is a physical impediment to cell removal. Therefore, a cost-effective strategy to induce microalgae to self-aggregate is desirable. We compared and contrasted two different strategies to induce auto-flocculation in *Auxenochlorella protothecoides*, a common production strain of microalgae:

- Self-recognition and aggregation: We have identified target cell surface proteins by trypsin digestion of whole cells and mass spectrometry (MS) analysis. Binding protein sequences specific to cell wall targets were fused to algal cell wall proteins in an attempt to induce aggregation.
- Cell surface charge induced aggregation (Figure 1): Expression of hyaluronic acid, a polyanion, was attempted in *A. protothecoides*. Aggregation that is induced with polycations or a drop in pH.

Background and Research Objectives

A significant constraint for the large-scale commercialization of the emerging algal biofuels industry is the financially and energetically costly process of harvesting biomass from ponds. There are two constraints that limit the efficiency of microalgae harvesting. These include, the small size (2-10 μm) of microalgal cells, and their very low densities in ponds ranging from 0.1-0.5% of the total mass. As much as 30% of the cost of producing algal biofuels is associated with the concentration of cells to a level that is workable for oil extraction. We proposed to take advantage of the biology of the algae to facilitate harvesting by expressing surface-exposed, self-aggregating biomolecules. These molecules were chosen for their

ability to induce auto-flocculation of algae into macro-scale aggregates that can be cheaply harvested using low energy, high throughput, and commercially scalable technologies (acoustic focusing, straining, settling). We expected to develop: 1) innovative technologies to control gene expression in Algae, 2) Expression of novel biomolecules that will efficiently flocculate algal biomass with virtually no energy costs. These results will lead to and energy efficient, economical methods for harvesting algae.

Scientific Approach and Accomplishments Hyaluronic acid production in *Auxenochlorella protothecoides*

Paramecium bursaria Chlorella virus (PBCV-1) contains 3 genes that it expresses upon infection of *Chlorella* NC64A that produce extruding HA chains from the algae. We searched the recently genome sequence of *A. protothecoides* (JGI) for genes necessary for the synthesis of HA. *A. protothecoides* contains homologs to all but the hyaluronic acid synthase, HasA (Figure 2).

To constitutively express HasA and A609L, we created a vector containing with the multiple cloning site connected to the paramomycin resistance gene, AphVIII (for selection in *A. protothecoides*), with a self-cleaving FMDV-1 linker. We placed our gene of interest for expression: HasA alone or HasA and A609L connected with the FMDV-1 linker to ensure that both proteins are expressed at similar levels.

A transformation protocol was developed and optimized for *A. protothecoides*. This is the first time the transformation of this organism has been reported. Transformants were screened by PCR for gene insertion and qPCR for mRNA expression. All transformants had HasA expression, but few expressed both HasA and A609L, most likely due to A609L following the antibiotic-resistance gene.

We tested for the extracellular expression of HA using hyaluronin binding protein (HABP)-biotin and avidin-FITC. Some cells stained green, an indication of hyaluronic acid on the surface, but not ubiquitously (Figure 3).

With our collaborator at Washington University, Robyn Roth, we examined mutant and wild-type cells for hyaluronic acid chains on the surface of cells using Deep Etch Electron Microscopy (DEEM) (Figure 4).

Mutants appear to have surface structure that differs from wild-type. In order to test for hyaluronic acid, we attempted several times to detect hyaluronic acid by agarose gel and ethidium bromide and Stains-All staining with a hyaluronic acid molecular weight marker (HA MW) and treatment with hyaluronidase to confirm hyaluronic acid presence in samples. The different stains help differentiate between DNA and protein or hyaluronic acid. Unfortunately, no long-chain hyaluronic acid was detected.

In order to induce flocculation, we added varying levels of cations and dropped pH in samples and observed them over time. Although we observed no obvious cell clumping or aggregation, cells were more sensitive to lysis. We are currently examining this characteristic for future studies. Easier cell lysis may be an advantageous quality when removing lipids for biofuel production.

After multiple unsuccessful attempts to show hyaluronic acid synthase protein expression in our lab, we have now sent samples to Kendrick Labs in Madison, WI for 2D SDS-PAGE for proteome comparison of wild-type cells to hyaluronic acid synthase-expressing mutants. These data should provide a conclusion to this portion of the ER, and provide the final piece of information for publication.

Cell wall proteome determination and tagging in *Auxenochlorella protothecoides*

A. protothecoides, obtained from Phycal, was grown in a 1 L flask of Sueko's HS media until stationary phase. Cells were centrifuged, washed twice with HS media and PBS, and centrifuged again. Cells were resuspended in a small volume of PBS and digested with trypsin for varying lengths of time, 30 min – 3 hr. Cells were removed from samples on a 50000 MWCO filter spin column. Samples were frozen at -80°C and sent to PNNL for mass spectrometry analysis. 10 µL was run on an SDS-PAGE gel. For one time point, 45 unique peptides were identified. In total, 233 protein sequences were found. Found 40 peptides in 30 min PBR digestion samples corresponding to 23 sequences. We BLASTed each sequence in the *A. protothecoides* genome, transcriptome, and the NCBI database; we also ran hydropathy plot analysis on potential candidates. We selected a protein that appeared repeatedly in digest-

ed samples and could be found in the transcriptome:

```
MEVEPSSTHRRVVNKEFQPKMVSARAFVLVVAISL-  
WAGVHADEVDSLLSTKKEWVDEALSSWEKVLAPVPKVETPPAK-  
VPKYVWPVPVPKEEPEVPSKDDLESELFAKFDLKPATPSPKPKPE-  
VELPAVTLPPKPEVEVKSVLPPVPEIKLPAVTLPIPEIKLPAVTLPP-  
VPEITLPAVTLPPVPEITLPAVTLPLPEFTLPAITLPLPEFTLPT-  
FTSP
```

Due to the presence of >45% PVKCYT residues, this protein is defined as a proline-rich protein. It has sequence similarity to mammalian periaxin and plant cell wall protein. Hydroxyproline-rich glycoproteins occur predominantly at the cell surface and are implicated in network formation, disease resistance, cell differentiation and morphogenesis (essential in root-hair growth). These proteins are extended rod-like molecules with highly repetitive peptide motifs. They are generally extensively post-translationally modified by hydroxylation of proline, O-glycosylation of Ser and Hyp residues, and both intra- and intermolecular cross-linking. Hydropathic analysis of the sequence indicated that it may have an extended rod-like structure.

We attempted two different protein-tagging experiments. In the first, we used a chitin-binding protein. Due to high chitin-content (~40%) in the cell wall of *A. protothecoides*, we attached a chitin-binding domain to induce cell flocculation:

```
MEVEPSSTHRRVVNKEFQPKMVSARAFVLVVAISL-  
WAGVHADEVDSLLSTKKEWVDEALSSWEKVLAPVPKVETPPAK-  
VPKYVWPVPVPKEEPEVPSKDDLESELFAKFDLKPATPSPKPKPE-  
VELPAVTLPPKPEVEVKSVLPPVPEIKLPAVTLPIPEIKLPAVTLPP-  
VPEITLPAVTLPPVPEITLPAVTLPLPEFTLPAITLPLPEFTLPT-  
FTSPGSGSGTTPNGVSAWQVNTAYTAGQLVTYNGKTYK-  
CLQPHTSLAGWEPSNVPALWQLQSRK
```

The sequence was inserted into our *A. protothecoides* expression vector, and transformants were screened for expression. We also expressed and purified GFP-CBP in *E. coli* to test binding of CBP to *A. protothecoides* with fluorescence microscopy compared to *C. reinhardtii* (a microalgae with no chitin in its cell wall) to confirm the CBP ability to bind to the *A. protothecoides* cell wall. Cells stained green, showing GFP-CBP binding (Figure 5).

Unfortunately, although we confirmed transformants with PCR and mRNA expression, we saw no noticeable flocculation of algal cells with this expression. In our second experiment, we tagged the cell surface protein with negatively or positively charged peptides, E-coil (glutamate polymer) or K-coil (lysine polymer). When combined, these coils bind to one another with very tight affinity (60 pM). By expressing each coil in two different mutants and combin-

ing them, we aimed to achieve flocculation by cells sticking to one another. These are utilized in Andrew Bradbury's lab for protein purification, immobilization, and antibody tagging. Although we successfully transformed with PCR and mRNA confirmation, we saw no noticeable flocculation of algal cells when combining E-coil tagged cells to K-coil tagged cells in the presence of cation, with a shift in pH, or in media alone.

This work was presented at the Los Alamos Postdoc Research Day in 2012 and 2013, receiving an Outstanding Poster Award Honorable Mention. It was also presented at the Algal Biomass, Biofuels, & Bioproducts conference in both 2012 and 2013. Lastly, this work was presented in multiple seminars, such as the Summer Science Lecture Series at LANL, invited talks to the Society of American Military Engineers and the Military Order of World Wars, and at site visits to the New Mexico Consortium Entrada building by multiple groups.

Impact on National Missions

As recognized in the final report of the NAABB Consortium, one of the major constraints limiting the economic and sustainable production of fuels from algae is the cost of harvesting algae. In ponds, algae account for 0.1% of the total mass, so substantial quantities of water need to be removed prior to fuel conversion. It was our hypothesis that the most efficient way to recover microorganisms at low density was to induce auto-flocculation. To meet this challenge we brought new capabilities to the lab to genetically engineer algae and to target gene expression to various compartments of the cell. Dr. Amanda Barry was hired to carry out this project as a postdoc and made substantial contributions to the overall algal biofuels program in addition to her ER project. She set up and maintains an array of 33 environmental Photobioreactors that are heavily used throughout LANL for phenotyping algae. Amanda has also been active in the LANL Postdoc Program.

At this stage, we have not yet identified an appropriate ligand to induce autoflocculation under constitutive gene expression. That being said, in the last month, we have developed a unique gene switch that is controlled by exogenously added xenobiotics. This gene switch technology will allow us to turn on the autoflocculation factors only at the time of harvest and reduce potential growth impairment associated with continuous expression of the transgenes. This advancement prepares for going forward for external funding opportunities to induce autoflocculation of cells to harvest biomass economically.

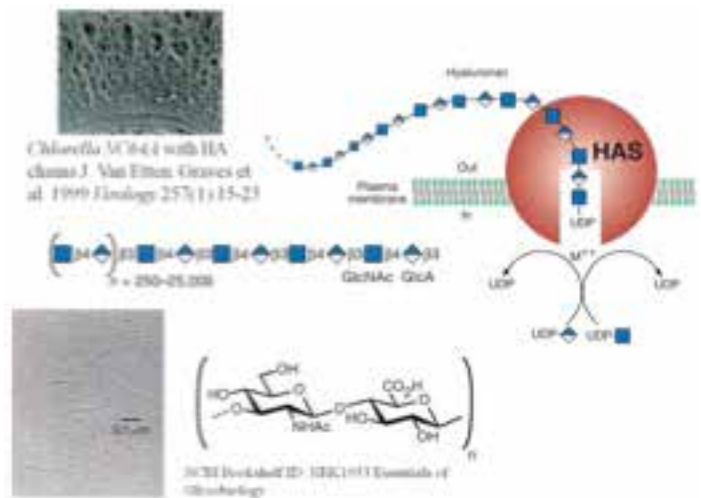

Figure 1. (A) Expression of hyaluronic acid on the cell wall of algal cells; (B) Cartoon of the structure of the membrane spanning protein, HasA and hyaluronic acid structure; (C) Expression of hyaluronic acid in *Bacillus subtilis*; (D) Molecular structure of hyaluronic acid.

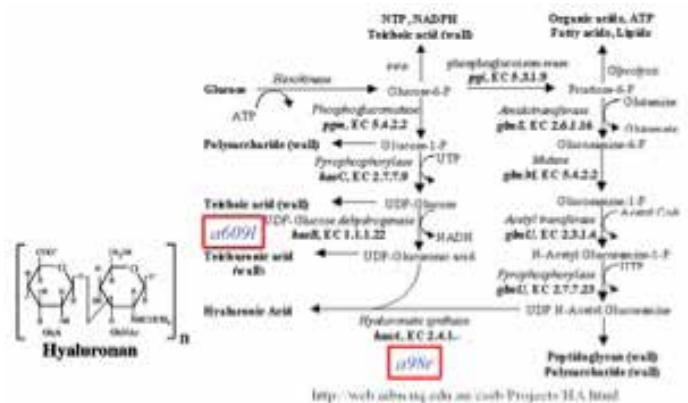

Figure 2. Pathway for the synthesis of hyaluronic acid (hyaluronan). Red-boxed proteins are those selected from the virus expressing hyaluronic acid to be expressed in *A. protothecoides*.



Figure 3. Detection of hyaluronic acid on the surface of wildtype (wt) or transformed (A1 mutant) algal cells using HABP-biotin and avidin-FITC. Cells appear green if stained

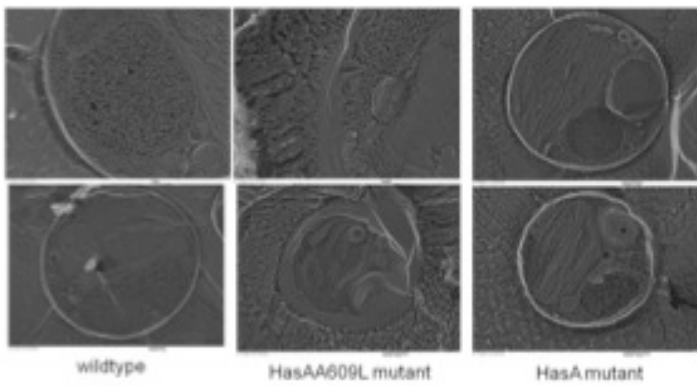

Figure 4. DEEM images of wildtype and transformed *A. protothecoides* cells. Two representative images of each.

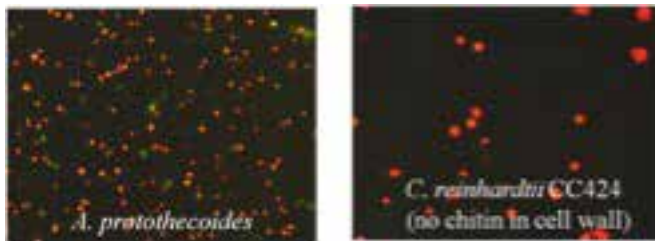

Figure 5. Algal cells examined for the presence of chitin in the cell wall utilizing chitin binding protein bound to fluorescent protein, GFP. Cells stain green if chitin is accessible

Publications

- Barry, A., S. Negi, N. Appuhamilage, S. Subramanian, N. Friedland, S. Pieris, T. Schaub, and R. Sayre. Impact of nitrogen limitation on biomass, photosynthesis, and lipid accumulation in *Chlorella sorokiniana* using a pond-simulated environment. *Bioresource Technology*.
- Barry, A., S. Starckenburg, and R. Sayre. Strategies for optimizing algal biology for enhanced biofuel production and carbon capture. *Frontiers in Energy Research*.
- Negi, S., A. Barry, N. Friedland, N. Sudasinghe, S. Subramanian, S. Pieris, F. Holguin, B. Duncan, T. Schaub, and R. Sayre. Impact of nitrogen limitation on biomass, photosynthesis, and lipid accumulation in *Chlorella sorokiniana* using a pond-simulated environment. *Bioresource Technol.*
- Subramanian, S., A. N. Barry, S. Pieris, and R. T. Sayre. Comparative energetics and kinetics of autotrophic lipid and starch metabolism in chlorophytic microalgae: implications for biomass and biofuel production. 2013. *BIOTECHNOLOGY for BIOFUELS*. 6 (1): 150.

Integrated Biosurveillance

Benjamin H. McMahon

20130810ER

Abstract

This project was a pilot study, demonstrating how to integrate three complementary disease detection approaches, from early diagnosis to complete characterization, in a human population with a high disease burden, and to generate a quantitative model that can improve our ability to combat the emergence of invasive and drug resistant pathogens. We successfully established a collaboration with a research group conducting a decade-long clinical research study in Siaya, Kenya, measured patient samples from this research study with all three of our diagnostic techniques, and produced an epidemiological model of circulating co-morbidities in the presence of complex mitigations of sufficient realism to guide the development and application of diagnostic assays in the full study. For the diagnostic development portion of the project, we simultaneously identified three distinct pathogens (non-Typhi Salmonella, HIV, and Plasmodium falciparum) and a drug resistance marker (the CAT-A chloramphenicol resistance gene) directly from a patient serum sample. We obtained strong positive signals in a novel molecular diagnostic assay for tuberculosis in several patients, matching their presumptive clinical diagnosis. We produced draft genomes of thirty representative Streptococcus and Salmonella isolates cultured from archived patient samples, identified and validated PCR reagents to identify these organisms, and identified several antibiotic resistance markers which have a presence / absence profile with high concordance to the antibiotic resistance profile measured in the clinical laboratory. For the modeling portion of the project, we developed a hybrid code to combine statistical analysis of clinical records of 1,652 patients making 18,853 visits to the clinic with an epidemiological model of nine co-circulating disease over a fifteen year period, from 2000 to 2015. This model was both a proof-of-concept and sufficiently detailed to inform prospective sample collection in the follow-on project.

Background and Research Objectives

Biosurveillance (BSV) is a National priority to ensure suitable response in the event of a natural outbreak, deliberate biowarfare, or an emerging infectious disease. BSV requires the development of diagnostics and pathogen characterization methods that can be successfully used in complex human populations, along with the systematic integration of clinical, demographic, diagnostic and pathogen characterization data, to provide situational awareness, perhaps in the form of an epidemiological model.

The National Biosurveillance Strategy [1] and implementation plan identifies three major technological gaps that need to be overcome for BSV of emerging infectious diseases: 1) early point-of-treatment diagnostics, 2) predictive epidemiological and forecasting models and 3) effective integration and analysis of big data. The goals of our project were to develop methods to overcome the first two limitations identified in the strategy, and to demonstrate the cohesive integration of experimental (diagnostics, characterization), clinical and geographical data to derive a multi-disease epidemiological model capable of informing the decision making process in future outbreaks in real time: Integrative Biosurveillance (Figure. 1).

To overcome existing limitations in point-of-treatment diagnostics, and to provide pathogen characterization for epidemiological modeling, we developed a tiered approach encompassing four types of diagnostics (Figure. 2). Clinical examinations (Tier 0 in Figure 2) are most frequently utilized for categorizing disease, but cannot reliably diagnose all conditions, such as systemic infection with drug-resistant Salmonella. Point-of treatment diagnostics (Tier 1 in Figure 2), currently used only for a small subset of diseases (e.g., influenza), can provide a reliable measurement of active infection, and guide treatment. For this, we want to develop and deploy fieldable assays for globally emerging human health threats: non-Typhi

Salmonella (NTS), Streptococcus sps, Staphylococcus sps (Staph), and Mycobacterium tuberculosis (TB), using the highly sensitive, rapid and fieldable LANL Biosensor. Critical information such as pathogen strain and drug-resistance cannot always be obtained by Tier 1 diagnostics, and PCR-assays (Tier 2 in Figure 2) for the amplification and detection of DNA fragments were developed and validated for this purpose. Finally, detection of low-prevalence emerging pathogens and drug-resistance is critical for BSV. For this, we applied DNA and Smart RNA Sequencing (SRS) (Tier 3 in Figure 2) to identify and further characterize the pathogens. Depending on the scenario, one can imagine a variety of combinations by which these measurements, shown in Figure 2, can be deployed to achieve situational awareness.

One of the most challenging aspects of our project is the direct investigation of diagnostics and modeling in a human population with a high prevalence of co-morbidities (e.g., invasive bacterial, viral and parasitic diseases, malnutrition). Co-morbidities, together with the indiscriminate use of antimicrobials, are primary pressures driving pathogen evolution, and consequently, the emergence of new invasive species and drug-resistant super-bugs [2,3]. For a diagnostic to be of value in humans and for the development of relevant models, inclusion of co-morbidities is critical, however technically and logistically challenging such a study may be. To address this challenge, we established a collaboration with a team of scientists in Kenya, led by Dr. DJ Perkins (UNM, KEMRI) [4]. This collaboration provides access to extensive clinical data and samples for one of the highest disease-burden populations in the world, Siaya (1652 pediatric patients, 18,853 clinical visits, 12 years), for retrospective study and method development, while allowing targeted prospective sample collection, uniquely positioning us to evaluate Integrative BSV using the SoS strategy (Figure 1). Our specific aims were to evaluate the feasibility in a full study to:

Discover novel disease signatures in clinical samples and develop rapid, field deployable assays for early detection of pathogens in complex backgrounds. Hypothesis: The human immune system is capable of recognizing specific pathogen signatures within hours of infection. Discovery of these 'conserved' signatures can enable development of rapid diagnostics for early detection of infection, both known and novel. This would be accomplished by: a) discovery of relevant biochemical signatures (lipids, sugars, proteins, and nucleic acids), b) developing sampling methods and reagents for assays, and c) selecting signatures for selectively discriminating between active infection and exposure and d) developing a sampling pipeline.

Validate disease signatures that measure active infec-

tion, disease prevalence and drug resistance in a high disease-burden population. Hypothesis: Diagnostics based on signatures discovered above can be utilized in clinical cohorts with confounding co-morbidities and complex backgrounds. Validation will be accomplished by measuring signatures in blinded clinical samples (deployment of Tier 1 and 2 assays in Kenya), and demonstrating: a) simultaneous detection of multiple pathogens, b) measuring low prevalence endemic pathogens (including select agents) and emerging drug resistant phenotypes by sequencing.

Develop epidemiological models to identify primary drivers of clinical outcome and drug resistance in a high burden population, through the integration of multiple data sources. Hypothesis: Integrating pathogen characterization data with diagnostic information, geospatial, demographic and longitudinal clinical outcome measures can identify important drivers of drug resistance and clinical outcomes, to guide resource allocation during an outbreak. We need to be able to: a) perform a systematic cost-benefit analysis of tiered diagnostics to optimize healthcare decisions, b) incorporate co-morbidities and intrinsic uncertainties in a human population into the decision making process, c) demonstrate an enhanced epidemiological model that can be readily deployed to inform decision makers in future epidemics.

BSV is defined as the continual observation of all aspects of disease pertinent for control, and involves the systematic study, collection, analysis, interpretation and dissemination of health data [5-7]. Historically, BSV in the US has focused on the intentional release of biowarfare agents [6]. This paradigm has, however, significantly changed with the release of the National Strategy [1] that identifies the need to survey all emerging infections, natural and engineered, especially drug-resistant strains. The latter concern is highlighted in the WHO Antimicrobial Resistance Report [8] that states that one of the greatest challenges today is the uncontrolled increase in drug resistance, and that transmission of super-bugs can be prevented by early diagnosis linked to decision support.

Effective BSV has been noted as the single most important instrument for identifying public health events [9]. Many BSV systems have been created with billions of dollars invested in the US alone, and successful examples include the Electronic Surveillance System for the Early Notification of Community-based Epidemics (ESSENCE), the CDC's BioSENSE [10], and BIOWATCH [11]. These systems provide syndromic or environmental surveillance [12], with limited application to novel outbreaks or unidentified pathogens. This is exemplified in recent cases: during the E.coli outbreak in Germany, it took weeks to identify the novel strain of the pathogen in bean sprouts [13]. With drug-

resistance, multi-drug resistant Staph aureus, first identified in E. Africa, is now common in the US and several other countries. Indeed, the National Academy of Sciences Global Infectious Disease Workshop identified that ‘diagnosis is the cornerstone of effective control and prevention efforts, including surveillance’ [14]. Thus, lack of early diagnosis is a critical limitation to BSV. Development of diagnostics for emerging threats, however, requires accurate pathogen characterization, which is not always included in BSV systems, posing a severe impediment to our ability to track such events in a timely manner. To facilitate sound decisions, information from multiple sources (clinical, geographical, laboratory) should be integrated into an epidemiological model that accounts for existing co-morbidities and pathogen characterization. Current models used in BSV [15] do not have the complexity necessary to characterize factors responsible for disease emergence in situ, limiting their application to surveillance of emerging infections. Integration of tiered diagnostics (Figure 2) with an epidemiological model grounded with clinical data and co-morbidities could overcome these barriers.

Scientific Approach and Accomplishments

In our 9-month feasibility study, we were successful at identification and procurement of clinical data and samples, creation of a baseline epidemiological model and preliminary evaluation of the tiered diagnostics. Integration of the diagnostics with the modeling will be achieved in the 3-year effort.

Epidemiological Model: We successfully analyzed data from 1,652 pediatric patients (18,853 visits), and produced a baseline epidemiological model with nine co-circulating diseases in 1,406 geographic compartments, and 5 age groups that can simulate three years of disease dynamics in one minute of computer time. This speed will enable sensitivity analysis and uncertainty quantification of the cost-benefit analysis of the deployment of the tiered diagnostics. The retrospective statistical analysis of the data resulted in some key findings that help constrain the epi-model. For example, Salmonella-bacteremia is a primary cause of mortality among pediatric patients and the type of habitation (screened vs. no windows) is the highest ranked demographic risk factor for malaria. We further discovered that two of the biggest information gaps for our modeling efforts are: lack of information on the composition of disease burden (prevalence) within the community; and lack of understanding of the transmission mechanisms for diseases and their drug-resistant profiles. This information will be derived from the tiered diagnostics.

Diagnostic Development: We developed methods for the three complimentary diagnostics, evaluated preliminary

sampling methods, procured required approvals, and received samples from Kenya. We successfully applied all three diagnostics to patient samples, as illustrated in Figure 3, demonstrating that we have both the required sample quantity and quality to achieve our goals.

PCR-assays (Figure 3a): We have identified bacteremia in patient blood using our real time (RT)-PCR (Figure 3a). PCR assays detected NTS in three samples, two of which were concordant with results from traditional microbial culture, and one (048-04C) in which Micrococcus, a likely skin contaminant, was identified through culture. To identify antibiotic resistance, we have used data from the published literature and our draft genomes to develop a panel of RT-PCR assays that detect a wide range of resistance genes.

Point of Treatment Diagnostics (Figure 3b): We successfully detected tuberculosis biomarkers in serum from pediatric patients with abnormal chest X-rays. If validated in a larger cohort, this can potentially be the first and only method for diagnosing active tuberculosis in children [16]. We developed antigenic lysates for Staphylococci and Salmonella sps isolated from patients in Siaya, and two assays for protein targets of Salmonella and Staphylococcus, and for lipopolysaccharide from Salmonella, using the LANL biosensor [17,18]. The precise choice of antigens for diagnostics requires further research.

Genome Sequencing (Figure 3c): We generated draft genomes of 21 samples selected for preliminary work. Using SRS, we have correctly identified HIV, NTS, and the malaria parasite, and bacteremia in blood, concordant with both the PCR results and clinical diagnostics performed at the hospital in Kenya (Figure 3a). We are confident that further optimization of the procedure as proposed has the potential of delivering a novel pan-diagnostic. Figure 3c shows that 100K pathogen genomic reads using RNA sequencing can be mapped onto a phylogenetic reference tree by Sequedex [19,20], further characterizing the transcripts for strain-typing, virulence, antibiotic resistance markers, and host immune responses²¹.

Impact on National Missions

The proposal integrates signature discovery with measurement in patients, and deployment of assays and models for BSV, corresponding to the SoS strategy. BSV has been a key SoS endeavor at LANL, and senior lab leaders organized a BSV Deep Dive in Sep 2013. During this, external experts (programmatic, academic, industrial) critically reviewed LANL strategy and investment in BSV, and the proposed concept was extensively appreciated as innovative, challenging and critical. Our effort requires the systematic integration of IS&T and experimental capabilities at LANL (Co-Design), which is not readily achieved in an academic

setting. This integration is not limited to BSV, and can be applied to other threats (nuclear, chemical, environmental) in the future. Multi-disciplinary research that harnesses our core expertise in experiment, modeling and computation is a critical niche for Biosecurity and a promising future area for LANL Bioscience.

This nine-month feasibility study has already generated several external grant proposals, two of which have already started work at LANL. Both are funded by the Defense Threat Reduction Agency (DTRA): one, on development of Smart RNA Sequencing, at the level of \$1,000k / year, and the other, delivery of a suite of epidemiological modeling tools, at the level of \$850k / year.

The ideas and code developed for this project enabled us to rapidly produce a coarse-grained model of the current West African ebola outbreak.

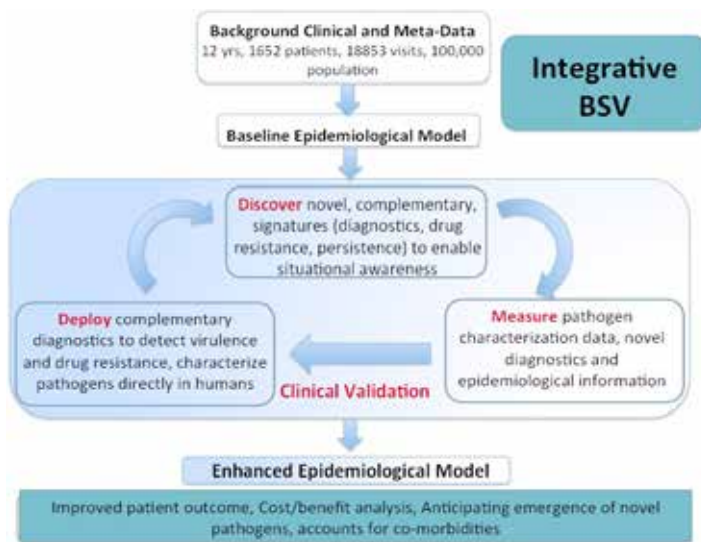

Figure 1. Overview of pilot project, illustrating how diagnostic development and deployment can be combined with mechanistic epidemiological modeling to provide integrative biosurveillance. The process begins with a baseline epidemiological model, fed by existing patient records and epidemiological characterizations of the study population. Over the course of the project, a process of discovering signatures of importance to measure, developing assays, and deploying assays occurs. As a result of this iterative process, an enhanced epidemiological model is produced, leading to improved patient outcome, cost / benefit analysis for the diagnostic assays, and an ability to anticipate emerging virulence and drug resistance among common bacterial pathogens.

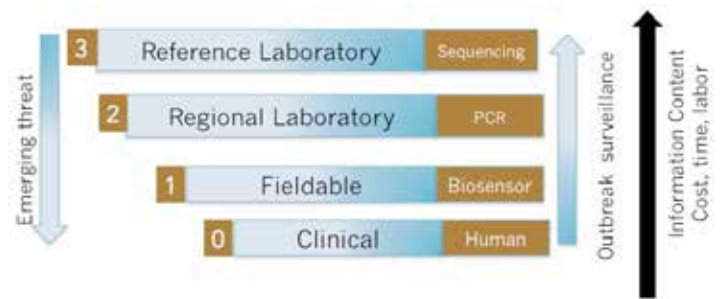

Figure 2. Schematic representation of our complimentary tiered diagnostics: The diagnostics developed in our project, RNA sequencing, PCR assays, and direct detection of pathogen biomarkers are designed to be representative of assays that may be deployed in a reference laboratory, regional laboratory, or in the field, respectively. All of the assays are understood to complement, not replace, clinical examination. The decision tree by which it is decided which samples are evaluated by each technique requires non-trivial optimization, and the information flow by which results inform epidemiological understanding is an important constraint informing our epidemiological model development.

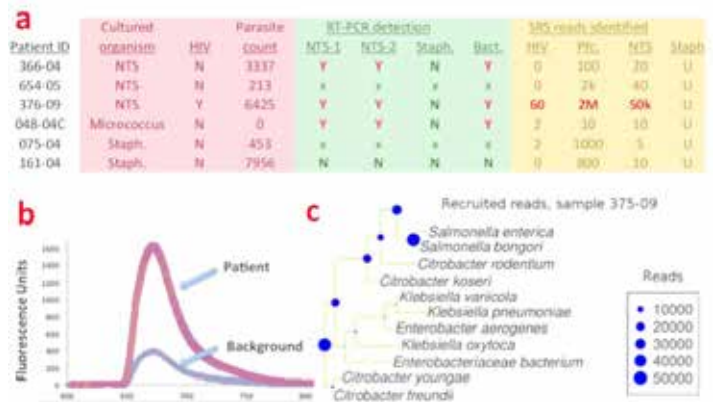

Figure 3. Data showing pathogen detection in patient serum, generated in this project: (a) compares results of multiple diagnostic assays on six serum samples. On the left are the bacterial pathogen identification, determined by culture, the results of HIV tests at the clinic, and the observed level of the parasite causing malaria. In the middle are the results of the LANL-measured PCR assays, showing positive detection of non-typhi Salmonella in three samples, the commensurate observation of bacteria (non-specific), and the lack of detection of Staphylococcus. To the right are the number of RNA sequence reads identified, for HIV, the malaria parasite, and non-typhi Salmonella. (b) shows the fluorescence emission spectrum for tuberculosis biomarker detection on our waveguide assay platform. (c) shows the phylogenetic profile of reads identified by our RNA sequencing effort, with over a million Salmonella reads sequenced directly from the RNA in patient serum. From these reads, we were able to assemble the chloramphenicol resistance gene.

References

1. National Strategy for Biosurveillance. 2012. White House.
2. Antimicrobial resistance: global report on surveillance. 2014. World Health Organization.
3. Pathogen evolution: microbial evolution and co-adaptation. A tribute to the life and scientific legacies of Joshua Lederberg: Workshop summary. 2009.
4. Were, T., G. C. Davenport, J. B. Hittner, C. Ouma, and J. M. Vulule. Bacteremia in Kenyan children with malaria presenting at a rural hospital in a holoendemic Plasmodium falciparum transmission area. 2010. J Clin Microbiol. : 671.
5. Last, J. M.. biosurveillance. 1995.
6. Biowatch and public health surveillance: evaluating systems for the early detection of biological threats: Abbreviated version. 2011. Institute of Medicine and National Research Council.
7. Report on global surveillance of epidemic-prone infectious diseases. 2000. World Health Organization.
8. Antimicrobial resistance: global report on surveillance. 2014. World Health Organization.
9. Castillo-Salgado, C.. Trends and Directions of Global Public Health Surveillance. 2010. Epidemiological Reviews. 32: 93.
10. Kman, N. E., and D. J. Bachmann. Biosurveillance: A review and update. 2012. Adv Preventive Medicine. : 10.1155/2012/301408.
11. Glodstein, B. D.. Biowatch and public health surveillance: Evaluating systems for the early detection of biological threats. 2011. National Academy of Sciences Report, Publication # 0-309-13971-6.
12. Buckeridge, D. L., X. Okhmatovskiaia, and M. Musen. Understanding detection performance in public health surveillance. 2007. J Biomed Informatics. 5: 760.
13. Vaidyanathan, G.. Better biosurveillance could halt disease spread. 2011. Nature.
14. Global infectious disease surveillance and detection: Assessing the challenges—Finding solutions, Workshop summary. 2007. National Academies Press.
15. Bian, L.. Spatial approaches to modeling dispersion of communicable diseases – A review. 2013. Trans. in GIS. 17: 1.
16. Marais, B. J., and M. Pai. Recent advances in the diagnosis of childhood tuberculosis. 2007. Arch Dis Child. 92: 446.
17. Martinez, J. S., W. K. Grace, K. M. Grace, N. Hartman, and B. I. Swanson. Pathogen detection using single mode planar optical waveguides. 2005. J. Mater. Chem.. 15: 4639.
18. Mukundan, H., A. S. Anderson, A. S. Grace, W. K. Grace, N. Hartman, J. S. Martinez, and B. I. Swanson. Waveguide-based sensors for pathogen detection, Invited Review. 2009. Sensors. 9: 5783.
19. Berendzen, J., J. D. Cohn, N. W. Hengartner, W. J. Bruno, C. R. Kuske, B. H. McMahon, M. A. Wolinsky, and G. Xie. Rapid phylogenetic and functional classification of short genomic fragments with signature peptides. 2012. BMC Res. Rep.. 5: 460.
20. Berendzen, J., J. D. Cohn, N. W. Hengartner, M. Dimitrijevic, and B. H. McMahon. Sequedex documentation. 2014. readthedocs.org.
21. Barczak, A. K., J. E. Gomez, B. B. Kaufmann, E. R. Hinson, and L. Cosimi. RNA signatures allow rapid identification of pathogens and antibiotic susceptibilities. 2012. PNAS, USA. 109: 6217.

Catalysts Containing Earth Abundant Metals for Energy Applications

John C. Gordon
20110752PRD3

Abstract

The focus of this research was on the chemistry of iron based catalysts pertinent to a variety of reactions with implications in energy research. Nature utilizes iron-based species for a wide array of demanding catalytic bond transformations (e.g. in extremely efficient hydrogenases), but our mechanistic understanding of these processes is poor. Expanding our knowledge of rudimentary organoiron chemistry would potentially have great impact in catalysis for energy using an earth-abundant metal.

Background and Research Objectives

Many industrial processes which underpin the production and utilization of feedstock chemicals are catalyzed by compounds containing precious metals. The global availability of these expensive metals is plummeting. It is paramount that in order to develop a sustainable chemical industry, such catalysts are replaced by examples containing earth-abundant elements. In light of this, the purpose of this project is to contribute an understanding of rudimentary organoiron and cobalt chemistry in a manner relevant to catalysis for energy using earth-abundant metals, which presents significant technical challenges compared with current technologies.

The primary research objective was to synthesize new coordination compounds based on iron and cobalt metals that have potential for catalytic activity. In particular, processes under examination included hydrogenation, hydrosilylation, hydroboration, aziridination and C-H activation.

Given the preliminary nature of this work, the molecular structure and properties of these compounds were examined in detail, in addition to their reactivity modes. Our secondary research objective was to study fundamental properties, including the electronic structure and stoichiometric reactivity, of these new complexes.

Scientific Approach and Accomplishments

A number of approaches were carried out experimentally, essentially varying the geometry, metal oxidation state and type of ligand. In particular, we used a variety of redox-active and -inactive ligands, in addition to proton shuttle type ligands based on basic amide donors. Several modes of reactivity were probed, including via metal-ligand multiply-bonded fragments and various types of metal-ligand cooperativity including bifunctional behavior.

Six main ligands were examined in detail. These were of the classes 6, 6''-disubstituted terpyridines (tpy-R2), N,N'-disubstituted-1,4-diaza-1,3-butadienes (DAB-R2), bulky diarylamines (R2NH), di-amino pyridine (PDA), phosphine-di-amine (PNP) and tri-amine (NNN). Tpy-R2 and DAB-R2 systems were investigated due to their potential redox-active nature, whereas R2NH, PDA and PNP were explored due to their potential bifunctional behavior as proton shuttle ligands. Tpy-R2, PDA, PNP and NNN ligands were designed in order to enforce a square-planar coordination geometry as recent results indicate this may be a key factor in promoting catalytic behavior for first row transition metals such as iron and cobalt.

As a result of the efforts of this project, a total of 21 new coordination complexes based on iron, cobalt and manganese have been fully characterized, including structural determination by single crystal X-ray diffraction, which represents a significant contribution to the field. The properties of these complexes have been probed by NMR, IR and EPR spectroscopies and cyclic voltammetry. This work showed that while some of these complexes have adopted the intended structure and have shown favourable properties for catalysis, several of the reactions characterized in this work demonstrated ligand and/or complex instability, effectively dead-ending some of our further studies on these compounds. Although less productive, valuable knowledge was also gained from these "negative" results which will inform future work for the

synthesis of similar compounds for catalysis.

Success was achieved with iron and cobalt complexes of the PDA ligand, as these compounds showed solution state stability, square-planar geometry (relatively rare for these metal centers) and contained an open site for substrate activation. These characteristics have previously been correlated to favorable catalytic reactivity for hydrogenation and hydrosilylation protocols. Future work will be required to fully appraise the catalytic properties of these compounds, but initial studies show that the iron derivative may catalytically transfer nitrene functionalities from organic azides. This work will be submitted for publication shortly in a manuscript entitled "Synthesis and reactivity of square planar diamido-pyridine complexes based on earth-abundant first row transition elements".

Catalytic activity has been unambiguously observed for a new cobalt PNP complex (hydrogenation, olefin isomerization) which provided a notable counterpoint to a related species which had a less acidic amine donor. This minor difference in these pro-catalyst structures led to a major difference in the structure of the active catalyst. The observed similarity in reactivity despite these differences indicated that these hydrogenation reactions may operate successfully via several different mechanisms.

Use of the NNN pincer ligand resulted in the formation of a new series of dimeric complexes which contain relatively rare Co=Co metal-metal bonds. It appears that these clusters cannot be easily broken up and therefore do not exhibit catalytic behavior, but nonetheless they represent a rare structural form which is of interest to the inorganic chemistry community and furthermore, outlines possible catalyst deactivation pathways. This work is detailed in a manuscript entitled "Metal-metal bonded transition metal dimers based on the diamino-amide ligand" and will be submitted for publication shortly.

In summary, as a result of this work, we have learned that numerous pathways for both activation and deactivation of first row transition metal complexes towards hydrogenation and hydrosilylation catalysis exist. This work has established new ligand frameworks for these metals which will undoubtedly guide future efforts towards realizing effective, robust catalysts based on earth-abundant elements.

Impact on National Missions

The impact of the ongoing development of earth-abundant catalysis is to create a sustainable chemical economy that is not reliant on diminishing mineral resources, and aims to liberate the US from escalating prices and political issues surrounding their import. Ultimately this work will lower

both environmental and economic costs of performing catalytic chemical production.

Determining Physiological Predictors of Climate-driven Forest Mortality

Nathan G. McDowell
20110756PRD4

Abstract

The response of the terrestrial carbon sink to the atmosphere is a major uncertainty in global change projections. Forests and woody vegetation, a major component of the terrestrial carbon pool, are vulnerable to die-off from drought. Improved projection of vegetation mortality and its effect on planetary climate could be achieved with algorithms accurately representing the physiological mechanisms of tree survival and mortality. We demonstrate in a multiple species data synthesis that xylem hydraulic failure was a nearly universal aspect of tree mortality physiology during drought, while reduced non-structural carbohydrates was not. However, such carbon starvation was a common process prior to death, especially for gymnosperms, and is therefore likely of particular importance in boreal forests. We also found a link between reduced non-structural carbohydrates at death to a lower xylem embolism resistance. These results illuminate a path forward for mechanistic prediction of tree drought mortality in a changing climate.

Background and Research Objectives

One of the greatest uncertainties in model predictions of global climate change is to what extent the biosphere will continue sequestering CO₂. Currently, forest ecosystems feed approximately 33% of all anthropogenic CO₂ emissions into organic matter but anticipated regional forest mortality events in response to rising temperatures and drought threaten positive feedbacks to atmospheric CO₂ and climate. Momentum in the field of plant mortality has been towards delving deeper into the physiology of mortality and a number of relevant experiments have been conducted. Yet no global model yet incorporates first-order physiological mechanisms, and there is a glaring, urgent need to transfer results into climate change models whose projections could influence global public policy

Our objectives were to synthesize the of tree drought mortality physiology data from around the world and

analyze species similarities and differences in how trees die from drought. Our goal is to provide the simplest, but strongest predictors of tree mortality across forest plant functional types for improved global change model development.

Scientific Approach and Accomplishments

We gathered data from studies published and unpublished that measured physiological responses at death of tree species. Data on non-structural carbohydrates and xylem embolism at death were then analyzed relative to control tree responses for each species in each study. We also related tree species mortality physiology to functional traits to enable prediction of mortality mechanism in species where we do not have at-mortality responses.

Impact on National Missions

This work directly supports DOE's Community Land Model. Addressing this key gap for coupled-vegetation climate models could lead to the rapid development of more accurate global change projections that are urgently needed to inform sound climate policy at a global level.

Publications

- Adams, T., and e. al. Nonstructural leaf carbohydrate dynamics of *Pinus edulis* during drought-induced tree mortality reveal role for carbon metabolism in mortality mechanism. 2013. *New Phytologist*. : 1142.
- Breshears, D., H. Adams, and e. al. The critical amplifying role of increasing atmospheric moisture demand on tree mortality and associated regional die-off. . 2013. *Frontiers in Plant Science*. 4: 266.
- Franz, T., and e. al. Ecosystem-scale measurements of biomass water using cosmic ray neutrons. . 2013. *Geophysical Research Letters*. : 3929.
- Zeppel, M., and e. al. Forest mortality due to drought:

latest insights, evidence and unresolved questions
on physiological pathways and consequences of tree
death. 2013. *New Phytologist*. : 372.

Nanosopic Recrystallization Dynamics and Phase Behavior in Liquid Crystals and Polymers

Juan Duque
20120770PRD3

Abstract

Composite systems, designed from the nanoscale up, are needed to successfully engineer the next generation of catalysts, sensors, and super-capacitors. A general challenge in generating composites from nano-scale “building-blocks” is integrating them so that they retain or enhance the properties of interest while obtaining microstructures with a useful layout. In this work, we aimed to understand material formation by monitoring the building blocks of formation dynamics. This was accomplished by building a microscope using a combination of three optical techniques superimposed on a diffraction-limited spot: Luminescence, Photothermal Imaging (PHI), and Raman Scattering (Scheme 1, Figure 1). Each of these well-established techniques brings a different element to structural analysis. Luminescence measures the position of fluorescent nano-sized objects and their interactions with the surrounding mesomaterial. PHI measures the position of non-fluorescent, absorbing nanoobjects and introduces local thermal agitation to measure properties of the surrounding mesomaterial. Raman measures nanoobject anisotropic properties, local temperature of the surrounding mesomaterial, and mesomaterial interactions with the incorporated nanoobjects. The combination of these three techniques allows selective probing of various aspects of the materials in question allowing for a broader scope of analysis. Understanding of the formation of materials will enable a control of material design that will put LANL at the forefront of material design.

Background and Research Objectives

Nanoparticles and nanomaterials have potential to dramatically surpass current technologies for catalysis, renewable energy systems, and environmental remediation, however, exploiting their valuable properties at more applicable length scales has been a difficult transition. Thus the current push to create mesomaterials; materials on length scales ranging from hundreds of nanometers to tens of microns. Recent advances in

mesocomposites have led to the development of a new class of materials formed by self-assembly of colloidal particles at liquid interfaces. These materials provide a powerful route to locking in non-equilibrium morphologies, through a process called interfacial jamming, while simultaneously opening up new interfacial chemistries, ultimately providing a robust and flexible design platform for the synthesis of multi-scale advanced materials with controlled functionality. The result is a bicontinuous emulsion with chemical functionality imparted by both liquids and the interfacial particle layer (a Bijel), where the phase separation becomes trapped far from thermodynamic equilibrium by a contiguous monolayer of nanoparticles that assemble along the interface to form a sample-spanning gel (Figure 1).

Since this is a non-equilibrium state, and the resulting structure is highly dependent on the path to completion, there is a need to develop simple, versatile methods to characterize these systems. This is not simple. Many mesomaterials incorporate nanoscale components, whether they are nanoparticles (spheres, sheets, or rods) or nanocavities (pores or channels). In some cases, these embedded nano-objects may only affect the local, nanoscale, properties of the matrix, while in other cases, nanoparticles affect the entire structure of the mesomaterial. Thus, new characterization techniques must accommodate various length scales while probing different aspects of the new mesomaterials to fully understand their properties. Moreover, direct visualization of material formation will offer information that can lead to new, application-specific design of materials (Figure 1).

Thus motivated, we built our new diffraction-limited, spatial resolution microscope combining correlated Raman, fluorescence, and photothermal imaging. We envision using these three powerful optical techniques as follows: Luminescence: measure the position of fluorescent nano-objects and track their interactions with the surrounding mesomaterial. Photothermal Imaging: measure

the position of non-fluorescent, absorbing nano-objects and measure thermal properties of its surrounding meso-material. Raman: measure the position of resonant nano-objects and indicate anisotropic properties and temperature of the surrounding mesomaterial. Importantly, our microscope not only couples these key optical techniques but has continuous laser excitation wavelengths ranging from 275 to 1000 nm and detection capabilities from the UV-visual to the near-infrared, making our microscope one of the few available world-wide to probe dynamics at the nanoscale (Figure 2).

Scientific Approach and Accomplishments

We developed the microscope and investigated the interaction between different nanomaterials and other molecules. During the microscope development, we spent a significant amount of time trying to understand nanoparticle/material systems to prepare for our microscope studies. That way we could develop the experiments necessary to interpret and properly track the dynamics of the material formation once the microscope was complete. Our results showed that we can track the aggregation of nanomaterial to composites, Figure 1 top right-hand.

Nanoparticles have been known to contribute to the bulk properties of materials. In most cases, these properties are beneficial. We used rheology (the study of fluid flows) to better understand the effect of the nanoparticles. Single-walled carbon nanotubes act as rigid rods in solution; the effect of rigid rods on solution viscosity is well understood. Thus, we developed a model that interprets the viscosity measurements in terms of a size distribution of nanotubes. We thus published (AIChE Journal) a technique to measure the length distribution of nanotubes, or any rigid rods for that matter, in solution. This model will be important in understanding the particle dynamics of asymmetric nanoparticles during material formation.

Conversely, nanoparticles are known to be highly sensitive to interaction with their local environment. To better understand this phenomenon, we focused on two areas of study. In both cases we used single-walled carbon nanotubes as sensitive, fluorescent probes. In order to disperse nanotubes in aqueous solution, wrappers are used. These wrappers sit in close proximity to the nanotube and thus can alter the optical signatures. First, we studied various wrappers by encasing the system in a silicon aerogel thereby removing influences from the water. We found that wrappings that hold tighter to the nanotube surface, and thus alter the optical properties in solution, are better suited for isolating them. This is important when designing materials for a particular optical signature. We are preparing these results for publication. Second, we looked at

molecular interactions of energy transfer molecules with the nanotubes in solution, also focusing on the wrappers used. For optically active wrappers, we found in some cases the energy can be transferred from the wrapper to the nanotube thereby creating nanotube fluorescence for previously inert nanotubes. We were also able to inject energy transfer molecules into the wrapped nanotubes to instigate energy transfer (Figure 3). Further experiments are still being conducted to understand how distance affects energy transfer, and an article is being written to report our findings. Knowledge of distances of electronic interaction will be important to future material design.

The last project was a collaboration that resulted in two publications in ACS Nano and NanoResearch. To stay at the forefront of nanomaterial design it is important to have nanoparticle additives with controlled properties. Single-walled carbon nanotubes come in two different electronic structures, metallic and semi-conducting, and vary in length and diameter, all of which dictates the fluorescent properties of the nanotubes. Because the nanotubes are such a mixed bunch, we cannot build efficient electronic devices. Our advance was to develop a simple bench top technique to isolate single-electronic property carbon nanotubes from all the rest, making them suitable for device design.

The development of our microscope and our improved understanding of nanoparticle/material interactions has put us in a position to create nanomaterials for the future.

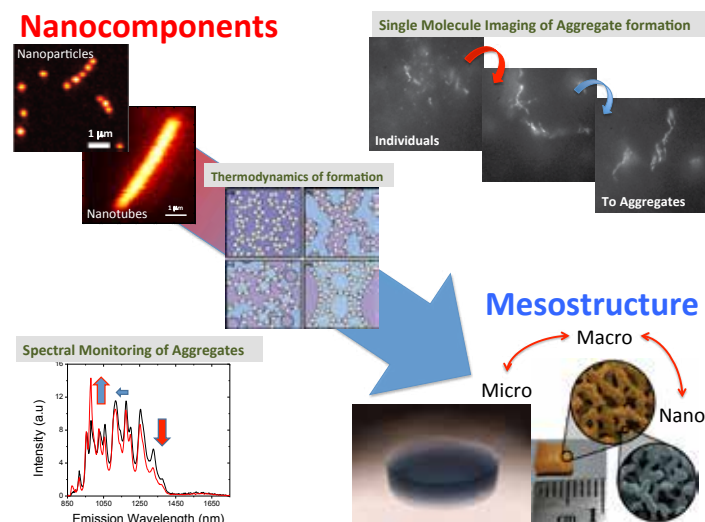

Figure 1. The transition from nanocomponents to mesostructures. The multiple measuring techniques enable us to image, for the first time, real-time location and mobility of various components within the meso-material elucidating formation dynamics, in particular, the transition from nano-structure to meso-structure. For instance: (top right) we are able to observed the aggregation dynamics of single-walled carbon nanotubes in solution indicating that we can monitor the transition from

building blocks to meso-structures. Finally, (bottom left), we see the changes in the photoluminescence as the aggregates form. In some cases, the photoluminescence of tubes decrease, while others increase accompanied by a shift in the peak location. These changes indicate the different interaction among nano-materials illustrating why the properties of the meso-composites in general are very different from those of the building-blocks.

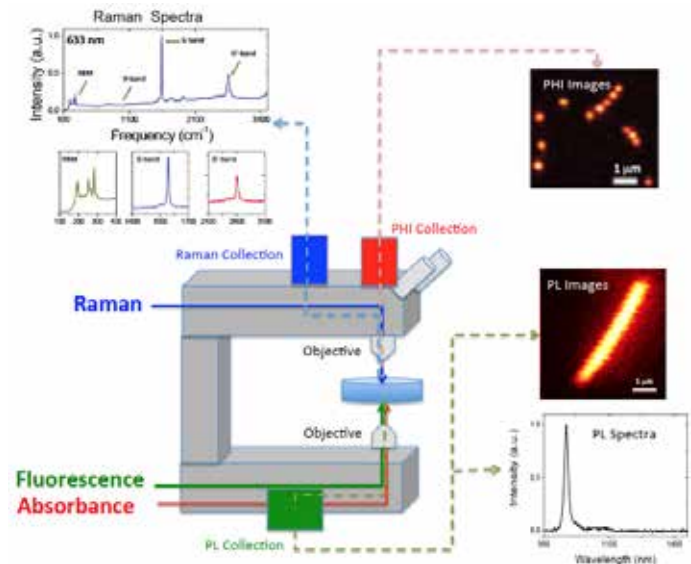

Figure 2. A representation of the diffracted-limited microscope with the 3 optical techniques (Raman, Fluorescence and absorbance). The microscope is capable of imaging emitting and non-emitting objects such as carbon nanotubes and gold nanoparticles, or any other semiconducting or metallic nanoparticle. Further more, we can obtain the photoluminescence and Raman spectra of desired materials. While the images allow us to track the building blocks and their formation kinetics, the spectra supply information on how the aggregation affects their intrinsic optical and electronic properties.

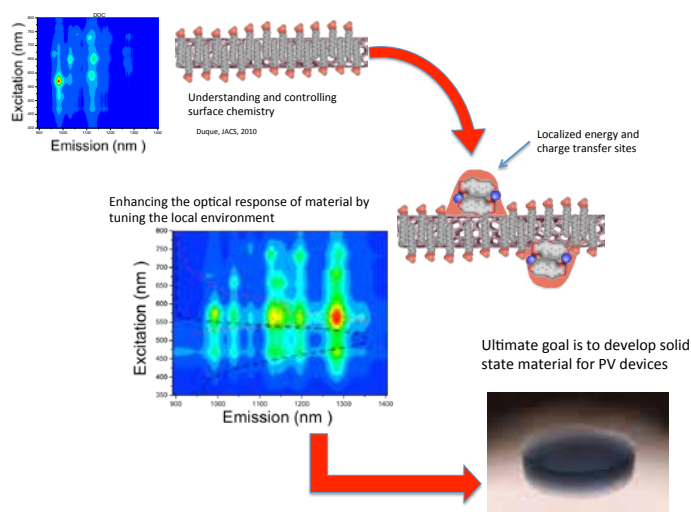

Figure 3. The energy transfer between carbon nanotubes and dye molecules. We see an increase in the optical properties of the tubes after these dyes are in contact with the nanotube surface. One of our future goals is to be able to develop solid state materi-

al that can potentially be important to understand new emergent signatures in complex mesocomposites. For these, the separation of specific electrical nanotubes is highly important.

Impact on National Missions

This research represents a transformative approach to designing the chemistry, morphology, and functionality of a material from the bottom-up; these systems are urgently needed to successfully engineer the next generation of catalysts, sensors, and super-capacitors where the microstructure matches with bulk properties.

The design of “next-generation” mesocomposites supported by this work is crucial to meet LANL’s National Security goals, for example advanced materials of interest to the DOE and DHS. For instance, our work has advanced our understanding of potential new materials capable of simultaneously sensing multiple agents. Furthermore, we are designing materials capable of self-healing after exposure to extreme conditions. More importantly we have developed a new laboratory capability by building a one-of-the-kind microscope system to enable new scientific discovery.

The findings of this work has been presented at national and international conferences as well as internally to program managers from global security and has resulted in a white paper on nanotube-based sensors. Moreover, the microscope developed is currently being used within the Chemistry Division to study oxygen isotopes and external to C-Division to study the homogeneous codispersion dispersion of materials. Finally, the work provided by Dr. Nicholas Parra-Vasquez has attracted the attention of MST-7, an applied materials science group, and he has joined that group with future conversion to staff a possibility.

Publications

Parra-Vasquez, A. Nicholas G., J. G. Duque, Micah J. Green, and M. Pasquali. Assessment of length and bundle distribution of dilute single-walled carbon nanotubes by viscosity measurements. 2014. Aiche Journal. 60 (4): 1499.

Subbaiyan, Navaneetha K., S. Cambre, N. Parra-Vasquez, E. Haroz, S. Doorn, and J. G. Duque. Role of surfactants and salt in aqueous two-phase separation of carbon nanotubes toward simple chirality isolation. 1619. ACS nano. 8 (2): 1628.

The Fate of the Three Dimensional Electron Far beyond the Quantum Limit

Ross D. Mcdonald
20120772PRD4

Abstract

Magnetic fields couple to the spin and charge of electrons in a metal in a very predictable manner; for most metals and available magnetic field strengths, this coupling is a small perturbation to the kinetic energy spectrum of the electrons, arising from quantization of the spin component along the field, and the orbital motion about the field. However, for the lowest carrier density metals, subjected to the highest experimentally available magnetic fields, the energy quantization from the magnetic field can exceed the electrons' kinetic energy – the materials quantum limit. Under these circumstances the interactions between electrons can dominate their behavior, giving rise to novel states of matter that are yet to be fully explored.

Background and Research Objectives

Under high magnetic fields, interacting electrons can exhibit numerous novel effects and states. In a two-dimensional electron gas, the non-trivial effect of electron-electron interactions can stabilize exotic states such as the fractional Quantum Hall effect, recognized by the 1998 Nobel Prize. To date, the fate of a three-dimensional (3D) gas of electrons beyond its quantum limit – where all electrons are orbitally quantized into a single Landau level – is an open subject for experimental exploration. In low-carrier semi-metals such as bismuth or graphite (stacks of graphene), the quantum limit ($H=9T$ and $7T$ along their highest symmetric axes respectively) is accessible with currently available magnetic fields. In bismuth, it is far from clear that non-interacting theory can explain all features resolved by experiment, including a resistivity minimum at 40 T and a peak in the Nernst (the transverse thermoelectric) effect, when the field is along the trigonal axis. By contrast, the electronic correlations in graphite are believed to cause it to undergo a high-magnetic-field-induced density-wave transition. Revealing the nature of this high field phase was the objective of this research.

Scientific Approach and Accomplishments

Measurement in the non-destructive 100 T pulsed magnetic system have allowed systematic exploration of these unknown phases of 3D electrons far beyond their quantum limit. At low temperature, magnetoresistance and magnetic susceptibility measurements on semimetal graphite and bismuth in pulsed field magnetic fields up to 92 T were employed to track quantum oscillations as Landau levels pass through the Fermi level below the quantum limit and search beyond it for abnormal phase transitions arising from correlations. Due to the anisotropy of electron and hole bands, varying the angle between the applied field and the crystalline axis tunes the strength of orbital quantization and magnetic length scales, and hence provides a means to tune the effect of correlations in high fields.

Tunable excitonic insulator behavior in quantum limit graphite: We have found that the magnetic field-induced insulating phase in the quantum limit of graphite exhibits the key features of an excitonic insulator phase, in which electrons and holes form tightly bound pairs across a semiconducting band gap. Angle-dependent magnetoresistance measurements reveal the peak transition temperature of the field-induced phase to be coincident with a critical point at which a Landau band gap is opened by the applied magnetic field. This excitonic insulator phase is asymmetric about the gap opening, consistent with a change from momentum-space pairing in the low field limit to a strongly coupled real-space pairing at high fields. We demonstrated that the orientation of the applied magnetic field tunes the effective electron-hole interaction strength. This provides an experimental system in which an excitonic condensate can be continuously tuned from the weak to the strong coupling limits. Our results show that ultra quantum graphite is a candidate material in which to explore broken symmetry states of matter such as a Bose-Einstein condensed superfluid and spatially ordered electronic crystal.

Impact on National Missions

Science and Technology Excellence: this work, and subsequent publications, demonstrates world leading experimental capabilities at LANL for materials characterization under extreme conditions supporting the Materials for the Future Science Pillar – specifically, expertise in performing resistance measurements at extremes of low temperature, high magnetic field and high rates of change of magnetic flux is vital to the National High Magnetic Field Laboratory User Program. The science of electronic correlations underlies our ability to understand actinide materials.

Publications

Lin, X., Z. W. Zhu, B. Fauque, and K. Behnia. Fermi Surface of the Most Dilute Superconductor. 2013. PHYSICAL REVIEW X. 3 (2): -.

Zhu, Z. W., A. Collaudin, B. Fauque, W. Kang, and K. Behnia. Field-induced polarization of Dirac valleys in bismuth. 2012. NATURE PHYSICS. 8 (1): 89.

Zhu, Z. W., B. Fauque, L. Malone, A. B. Antunes, Y. Fuseya, and K. Behnia. Landau spectrum and twin boundaries of bismuth in the extreme quantum limit. 2012. In PROCEEDINGS OF THE NATIONAL ACADEMY OF SCIENCES OF THE UNITED STATES OF AMERICA. Vol. 109, 37 Edition, p. 14813.

The Role of Microscopic Eye Movements in Visual Perception

John S. George
20120773PRD4

Abstract

Our eyes are constantly in motion, even during periods of fixation. Traditionally, the role of fixational eye movements has been difficult to study due to the small size of these eye movements and limited technologies to measure them. With advances in electrophysiological measurements and high-speed imaging, we have investigated the role of fixational eye movements. First, we simulated the smallest of these eye movements, called ocular tremor, on isolated retinal tissue and measured electrophysiological responses from retinal ganglion cells. We found that cells fired synchronously to the frequency of the stimulus jitter whereas cells randomly fired to a stationary stimulus. These findings suggest that ocular tremor may help encode visual information through synchronous firing of cells. Second, we developed the capabilities to measure intrinsic optical responses from isolated tissue. We simultaneously measured electrophysiological and optical response from retinal tissue following brief visual stimuli. Intrinsic optical responses have similar onset times to electrophysiological measurements but longer recovery times. Additionally, intrinsic optical responses preserve the spatial features of the stimulus pattern as well as the spatial features of the photoreceptors. Third, we measured fixational eye movements in live salamanders using high-speed video microscopy as a first step in characterization of the frequency and amplitude components. These studies have provided further insight into the role of ocular tremor in vision processing and leads to a better understanding of how the brain encodes information. Better interpretation of neural signals is important for diagnostics of pathological conditions, improvements of neural prosthetic devices, and developments of neural-inspired computation systems.

Background and Research Objectives

Eye movements are fundamental for processing and perceiving visual information about the surrounding world. Large-scale eye movements, called saccades, facilitate

exploration of the visual environment by successively positioning the fovea (the region of retina that provides greatest visual acuity) on areas of interest in the visual field. During periods of eye “fixation,” microscopic eye movements—shifts on the order of a photoreceptor cell—are observed in all vertebrate animals [1]. Due to complex experimental requirements, the role of these movements, called ocular tremor, is not well understood. We hypothesize that ocular tremor contributes to low-level visual processing by generating patterns of synchronous firing between neighboring retinal neurons, and that correlated firing encodes unique spatiotemporal visual information, improving signal-to-noise ratios and visual acuity. I studied neural firing in response to visual stimulation of isolated retina; ultimately we hope to characterize the perceptual consequences of eye movements in human subjects. These experiments are inspired by LANL computational models that simulate retinal and neural consequences of ocular tremor. The work exploits laboratory technologies for high spatial/temporal resolution measurement of neuronal function in order to provide further insight into visual signal encoding and processing.

Specific Aim 1: Simulate ocular tremor in an isolated amphibian retina by jittering a visual stimulus, while measuring electrophysiological activity of retinal neural populations. I used commercial microelectrode arrays, as well as high-density nano-pillar arrays developed and fabricated at CINT, for high fidelity neural measurements of neural ensemble firing patterns. The objective was to characterize neural firing patterns in response to moving stimulation patterns, and to confirm the proposed physiological foundation of perceptual enhancement.

Specific Aim 2: Correlate neural spiking activity to intrinsic optical responses of isolated retina. Electrophysiological activity alters the optical properties of neurons and can be used to measure subthreshold activity and responses of specialized “analog” neurons of retina, as

well as the spiking activity of the retinal ganglion cells that constitute the optic nerve. I combined high-speed video microscopy with high-density electrophysiological measurements to investigate the relationship between neural firing patterns and optical responses imaged in retina.

Specific Aim 3: Characterize and simulate ocular tremor in the human eye. I used high-speed optical imaging techniques to characterize optical tremor in a salamander eye, to assess the potential role of oscillatory encoding role of visual information.

Scientific Approach and Accomplishments

In order to simulate ocular tremor in isolated retinal tissue, as outlined in the first specific aim, we coupled a projector to a microscope and presented a series of visual stimuli that were either stationary or jittered at a frequency range on par with ocular tremor frequencies. The visual stimulus pattern and frequency was varied and while we recorded electrophysiological responses using microelectrode arrays. We found that retinal ganglion cells synchronized their firing patterns to the frequency of jitter whereas the firing patterns appeared random to stationary stimuli (Figure 1). These results corroborate findings from our computational models that suggest fixational eye movements may improve visual acuity by synchronizing retinal ganglion cell firing to help encode visual information [2].

Simultaneously we measured intrinsic optical responses and electrophysiological responses from isolated retinal tissue, as outlined in the second specific aim. Using the stimulus setup from the first specific aim, we stimulated the retina with a brief flash of light 50 μm in diameter. Intrinsic optical responses were measured as a change in light intensity divided by the background light intensity (dI/I) from the photoreceptors from the region where the stimulus light impinged on the tissue (Figure 2). The edges of the photoreceptors elicited the largest response with some edges having positive responses and some edges having negative measurements. Moreover, some photoreceptors showed both polarity responses on opposite edges of the cell. Electrophysiological data were simultaneously measured along with the intrinsic optical signals. The intrinsic optical responses had a fast onset similar to the electrophysiological measurement, but showed a long recovery (Figure 3). The optical signals may be due to cellular swelling and the long recovery may indicate a longer time period for the cell to return to chemi-osmotic equilibrium [3,4]. Intrinsic optical responses have a similar time course to electrophysiological measurements, but also preserve spatial information of the activated cells, which provides advantages over traditional electrical measurements. We measured responses from different stimulus

illumination intensities to tease apart the graded response from the photoreceptors as recorded optically from the all-or-none response from the retinal ganglion cells as recorded electrically. These data may provide more insight into the relationship between intrinsic optical and electrophysiological responses.

As a first step in specific aim 3, we recorded fixational eye movements in living salamanders using high-speed video microscopy. Following approval from IACUC, we restrained the animals and imaged the eye under a microscope, fixating on a feature such as a blood vessel and collected video at high frame rates. Post processing techniques can be applied to track features in the image and measure eye movement amplitudes and frequencies. This information can be used to improve the simulated tremor in isolated retina to better mimic natural eye movements from the animal. Furthermore, we can correlate the electrophysiological responses to different jitter frequencies with the actual eye movement frequencies. We expect that the largest synchronization of cell firing will occur at jitter frequencies similar to the natural eye movement frequencies such that the eye movement is tuned to generate the largest synchronous responses from cells and improving visual information encoding.

We have also explore possible future collaboration with Ethan Rossi, University of Rochester, which would allow us to extend these studies to human subjects, using a fundus camera with adaptive optics to allow us to correct aberrations in the physiological optics of the eye, in order to visualize photoreceptor location and physiological responses.

Impact on National Missions

The objective of the work is to better understand the mechanism that supports the encoding and processing of visual information by the retina and cortical visual systems of the brain. This work will enable better interpretation of neural signals for diagnostics of pathology, and facilitate treatment of retinal degeneration or neural injury via neural prosthetic devices such as those developed with DOE support in the Artificial Retina project and by NIH. The work will also enhance our understanding of neural mechanisms of visual cognition, supporting the development of neural-inspired computation systems for image processing and interpretation. Such efforts have been supported by recent and ongoing LDRD projects and are highly relevant for missions in DOE, DoD, and the intelligence community that rely on computer vision to process large volumes of imagery, e.g. from surveillance drones.

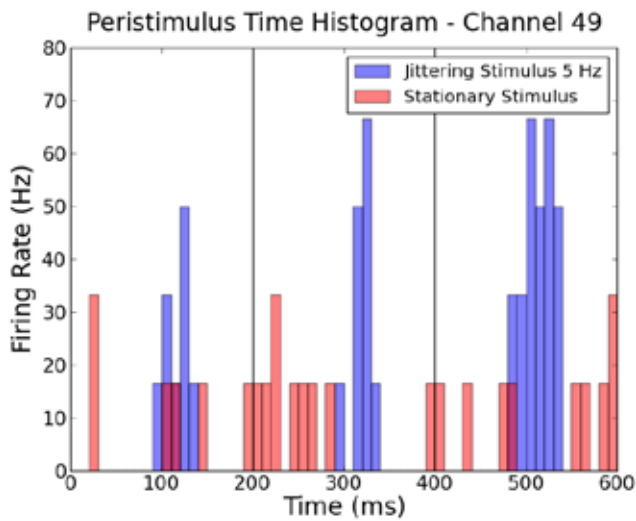

Figure 1. Peristimulus time histogram of electrophysiological spikes recorded in response to a stationary or jittering stimulus. Note that jitter imposed a temporally correlated pattern of activation, while the static stimulus elicited random spikes.

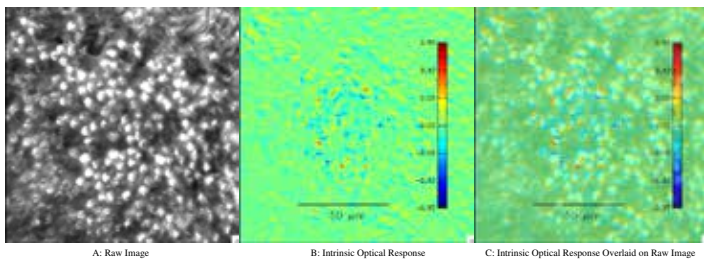

Figure 2. Intrinsic optical responses associated with visual activation of photoreceptors.

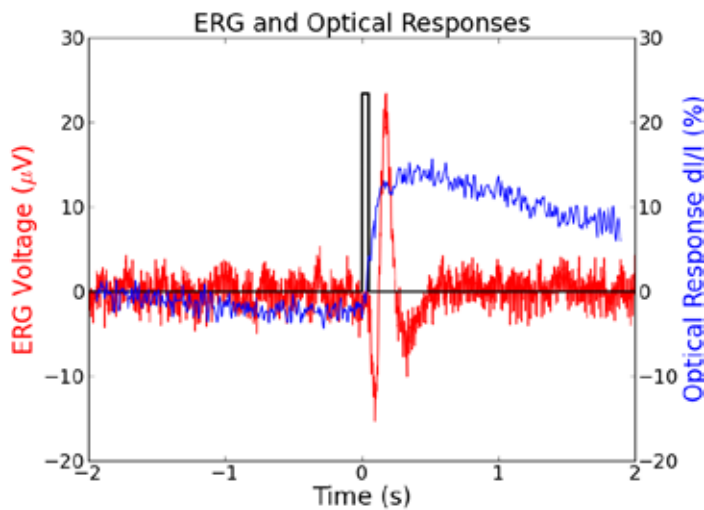

Figure 3. Timecourses of Electroretinogram (ERG) and optical physiological responses of retina elicited by light.

References

1. Martinez-Conde, S., S. L. Macknik, and D. H. Hubel. The role of fixational eye movements in visual perception. 2004. *Nature Reviews Neuroscience*. 5: 229.
2. Kenyon, G. T. Extreme synergy: Spatiotemporal correlations enable rapid image reconstruction from computer-generated spike trains. 2010. *Journal of Vision*. 10(3) (21): 1.
3. Yao, X. C., D. M. Rector, and J. S. George. Optical lever recording of displacements from activated lobster nerve bundles and *Nitella* internodes. 2003. *Applied Optics*. 42 (16): 2972.
4. Faust, A. J., and D. M. Rector. Optically teasing apart neural swelling and depolarization. 2007. *Neuroscience*. 145: 887.

Publications

George, J., J. L. Schei, P. Schultz, and G. Kenyon. Implications of microscopic eye movements for retinal encoding. 2013. In *Vision Sciences Society*. (Naples, FL, 10-15 May 2013). Vol. 13, 9 Edition, p. 1341. New York: *Journal of Vision*.

Schei, J. L., G. Kenyon, and J. George. Contributions of microscopic eye movements to retinal encoding. 2013. In *Optical Society of America Vision Meeting*. (Houston, 4-6 Oct. 2013). Vol. 13, 15:T Edition, p. 15. Washington, DC: *OSA Journal of Vision*.

Access to Industrially Important Chemical Compounds by Direct Hydrogenation of Biomass Derived Molecules Containing Carbonyl Fragments

John C. Gordon
20120774PRD4

Abstract

The development of new methods for mild and selective hydrogenations of polar functionalities contained within cheap and widely available biomass derived compounds would provide routes to highly desirable building blocks for the pharmaceutical, polymer and optoelectronic industries. In particular, the hydrogenation of ureas, organic carbonates, carbamates and formates is of significant global interest since these classes of compounds can be produced from CO₂ and CO.

Background and Research Objectives

In contrast to ketones and aldehydes, carbonyl containing moieties such as esters, carboxamides, as well as carbonic acid derivatives are extremely difficult to hydrogenate. Industrially important catalytic reduction of esters using molecular hydrogen, (the most atom-efficient and widely available reducing agent), into valuable chemicals is still carried out under extremely forcing conditions, typically over a heterogeneous catalyst at 20- 60 atm H₂ pressure and 200-300°C. Given the fact that biomass-based routes are expected to make a significant impact on the production of bulk chemicals within 10–30 years, and that a huge fraction of species will be derived from esters, carboxamides and carbonic acid derivatives mild, catalytic hydrogenation of these important compounds will influence the evolution of biofuels production in the upcoming years. Our aim is to develop new classes of effective hydrogenation catalysts containing earth abundant metals that can affect such transformations.

Scientific Approach and Accomplishments

A series of novel achiral and chiral ligands have indeed been prepared as well as a number of their metal complexes, including those of several earth abundant metals. Several of these systems appear to offer possible advantages over current ones with respect to their stability towards air and moisture. Due to these properties we believe that such molecules may exhibit greater

ease of use in their hydrogenation chemistries. We have filed an IDEAS disclosure to determine whether or not these complexes represent IP that LANL wants to protect. We will be publishing two or more papers on the chemistry that we have unearthed, but want to protect IP (and any potential licensing opportunities) as well. We believe that a number of the molecules we have prepared are promising candidates for the hydrogenation of a variety of ketonic substrates.

Impact on National Missions

The industrial homogeneous reduction of esters still relies mostly on the stoichiometric use of metal hydride reagents such as LiAlH₄ or NaBH₄ (where selectivity cannot be controlled and waste generation results), or by means of heterogeneous catalysis (high temperatures and pressures are required and selectivity cannot be controlled). Success in this chemistry could therefore have significant positive impact for LANL, vis-à-vis the application of sustainable approaches to new polymers and materials synthesis, in energy applications, and in health related (pharmaceutical) R&D. This is in line with the DOE's mission in the energy arena. New, more effective catalysts can result in less forcing reactions conditions (lower temperatures and pressures), thus saving cost in large scale catalytic processes. This kind of chemistry is of importance to DOE OBES and DOE EERE.

Publications

Dub, P. A., N. J. Henson, R. L. Martin, and J. C. Gordon. Unraveling the Mechanism of the Asymmetric Hydrogenation of Acetophenone by [RuX₂(diphosphine)(1,2-diamine)] Catalysts. 2014. *Journal of the American Chemical Society*. 136: 3505.

Chemically Modifying the Uranyl Ion

Jaqueline L. Kiplinger
20120750PRD2

Introduction

The uranyl ion, $[\text{UO}_2]^{2+}$, is the most ubiquitous form of uranium. The metal-oxygen bonds in this linear molecule are incredibly strong, making uranyl complexes very stable. Because uranyl complexes are so stable, they are resistant to modifications—modifications that could lead to easier separations, or improved nuclear fuel reprocessing, for example. In this context, chemically modifying a uranyl complex by connecting a carbon ligand to it is a very challenging but important goal. A molecular uranyl complex containing a metal-carbon bond, also called an organometallic uranyl complex, would be of interest because solid-state uranium carbide materials can be used in the new generation of safer nuclear reactors. We propose to prepare stable organometallic uranyl complexes using a straightforward method. These well-defined molecular compounds will be valuable because they enable a range of experimental and theoretical studies that are not available using solid-state materials.

Benefit to National Security Missions

The goals of this project are to synthesize and characterize a rare thorium and uranium fluoride complexes. Within the field of actinide chemistry, this work will have a considerable impact, not only because examples of these complexes are so uncommon, but also because the methods we propose will be adaptable for widespread use by the chemistry community, and across the actinides. Characterizing and studying the chemistry of these fluoride compounds could find relevance in the nonproliferation community.

From the fluoride chemistry we discovered how to prepare the first molecular thorium bis- and tris-azide complexes. An azide can be converted into a nitride by loss of dinitrogen. Actinide nitrides are alternative fuels for nuclear reactors; therefore, we need a better understanding of actinide nitrides for their safe storage, usage, and waste reprocessing. Organoactinide nitride com-

plexes can be studied to gain such understanding, and organoactinide azides are an entry to such studies.

Progress

The following discoveries were made:

New routes to uranium fluoride complexes

The complexes prepared are rare examples of well-defined uranium fluoride complexes. We plan to publish this work in *Chemical Communications*.

New C-Br, C-Cl and C-F bond activation chemistry mediated by a uranium metal center

This type of reaction chemistry is well known for transition metals but is exceedingly rare for actinide metals. This is new chemistry for uranium. We plan to publish this work in the *Journal of the American Chemical Society*.

Prepared the first organometallic thorium bis- and tris-azide complexes

This work is currently being written up and will yield at least three high-profile publications (*JACS*, *Chem. Sci*, *Nature Chemistry*). If these complexes can yield the first thorium nitride, then this reactivity would qualify for publication in *Science* or *Nature*.

Future Work

The original goal of this project was to prepare stable uranyl complexes of the type, $[\text{L}]\text{UO}_2\text{Cl}$ (where L = bulky ligand). Numerous bulky ligands were explored but all efforts produced results consistent with unwanted reaction chemistry of the supporting ligand and did not yield a monomeric uranyl fluoride complex. We therefore modified the scope of this project.

Planned tasks for this project are as follows:

- Finish the exploration of the chemistry of $[\text{L}]\text{ThF}_2$ and $[\text{L}]\text{Uf}_2$ (where L = bulky ligand) complexes

- Finish and publish a manuscript on the new synthetic method for the high-yielding preparation of thorium and uranium fluoride complexes. We will file a patent application for this work.
- Finish and publish a manuscripts on: the synthesis of the first thorium bis(azide) complexes, and the synthesis of the first thorium tris(azide) complexes.
- Obtain nitrogen K-edge spectroscopy on these thorium azide complexes and couple this with a theoretical study to understand the electronic structure of these novel compounds.
- Explore the reaction chemistry of these thorium azide complexes to see if they can yield the first thorium nitride complex.
- File a patent application on the thorium azide work.

Conclusion

The main project goals are (1) to synthesize and characterize a rare uranyl fluoride complex and (2) to use this uranyl fluoride complex to synthesize a uranyl complex containing a uranium–carbon bond. Within the field of actinide chemistry, this work will have a considerable impact, not only because examples of these complexes are so uncommon, but also because the methods we propose will be adaptable for widespread use by the chemistry community, beyond uranyl complexes and across the actinides.

Publications

Monreal, M. J., B. L. Scott, and J. L. Kiplinger.

Organometallic thorium azide complexes: using steric pressure to control structure . Invited presentation at LANL Postdoctoral Women's Group Colloquium. (Los Alamos, February 26, 2014).

Monreal, M. J., B. L. Scott, and J. L. Kiplinger.

Organometallic thorium azide complexes: using steric pressure to control structure. Invited presentation at LANL Women's History Month Panel and Poster Session. (Los Alamos, NM, March 31, 2014).

Monreal, M. J., B. L. Scott, and J. L. Kiplinger.

Organometallic thorium azides: metallocene sterics govern structure . Invited presentation at Laboratory Directed Research and Development Program Review. (Los Alamos, NM, ay 14, 2014).

Monreal, M. J., B. L. Scott, and J. L. Kiplinger.

Organometallic thorium azide complexes: steric pressure controls structure . Presented at LANL Postdoc Research Day. (Los Alamos, NM, June 11, 2014).

Monreal, M. J., B. L. Scott, and J. L. Kiplinger.

Organometallic thorium azide complexes . Invited presentation at 27th Rare Earth Research Conference.

(Squaw Valley, CA, 22-26 June 2014).

Monreal, M. J., R. J. Wright, J. T. Golden, D. E. Morris, B. L. Scott, P. P. Power, and J. L. Kiplinger . Thorium(IV) and uranium(IV) halide complexes supported by bulky β -diketiminato ligands. 2013. *Organometallics* (Invited Article – Special Issue: Recent Advances in Organo-f-Element Chemistry). 32: 1423.

Monreal, M. J., R. K. Thomson, B. L. Scott, and J. L. Kiplinger. Enhancing the synthetic efficacy of thorium tetrachloride bis(1,2-dimethoxyethane) with added 1,2-dimethoxyethane: Preparation of metallocene thorium dichlorides. 2014. *INORGANIC CHEMISTRY COMMUNICATIONS*. 46: 51.

Travia, N. E., M. J. Monreal, B. L. Scott , and J. L. Kiplinger. Thorium-mediated ring-opening of tetrahydrofuran and the development of a new thorium starting material: Preparation and chemistry of ThI₄(DME)₂. 2012. *Dalton Transactions*. 41: 14441.

Travia, N. E., M. J. Monreal, B. L. Scott, D. E. Morris , and J. L. Kiplinger. Developing the next generation thorium iodide starting materials. Invited presentation at 243rd American Chemical Society National Meeting. (San Diego, California, 25-29 March 2012).

Travia, N. E., M. J. Monreal, B. L. Scott, and J. L. Kiplinger. A new starting material for thorium chemistry: ThI₄(DME)₂. Presented at Gordon Research Conference on Inorganic Chemistry. (University of New England, Biddeford, Maine, 17-22 June 2012).

Catalytic Mechanism and Inhibition of Metallo-beta-lactamases (MBL): The Ultimate Threat Against Antibiotics

Ryszard Michalczyk
20120776PRD4

Introduction

The proposed work will utilize an innovative research strategy that is LANL-unique for novel antibiotics. We will combine neutron and X-ray diffraction to obtain high resolution structures and detailed information on how metallo beta-lactamases (MBLs) work to degrade clinically used antibiotics. Due to their readiness for horizontal transfer and evolution, MBLs entail a serious public health threat, with increasing antibiotic resistance found all over the world. Results will have direct implications for not only understanding how these enzymes work, but also to enable the design of clinically useful antibiotics not susceptible to breakdown by these harmful enzymes.

Benefit to National Security Missions

Metallo beta lactamases comprise a serious human health issue due to the innumerable complications associated with untreatable infections caused by some of the most dangerous bacteria present in clinical settings and intensive care units. This work, which can only be performed at LANL's world-class facilities, will provide the first neutron structures for antibiotic resistance enzymes found in multidrug resistant pathogens. This work will advance our basic understanding of enzyme mechanisms and drug binding. Neutron diffraction is underutilized for drug design and is the only technique that can give unique data on drug binding and degradation. This work may lead to novel compounds that will have an enormous impact on human health and disease. We also envision a scenario where detection methods can be developed to find bacteria expressing resistance genes in the environment. This work directly addresses mission relevance in the fields of basic health research, bioscience, and pathogen detection.

Progress

The project comprises three main objectives centered on structure-function relationships of metallo- β -lactamases

(MBLs): (1) Mechanism of water activation, (2) Mechanism of substrate binding, and (3) Inhibition. The third objective has been re-scoped to reduce safety and security risks. It replaces originally proposed enzyme evolution objective. The progress is detailed below.

Mechanism of water activation

Two MBLs are currently being studied: NDM-1 from *K. pneumoniae* and BcII from *B. cereus*. Both wild-type enzymes are being expressed under BSL-2 conditions under IBC-127-2013. This objective will be achieved through solving neutron structures, for which mm-size crystals are needed, which requires large amounts of pure protein. The wild-type NDM-1 enzyme proved to be difficult to express in *E. coli* BL21(DE3) in a native form due to proteolysis. After several unsuccessful attempts to determine conditions in which NDM-1 would express in a native form (adjusting induction growth temperature and length, use of IPTG or autoinducing media, use of protease inhibitor cocktails) we decided to focus first on the other MBL, BcII (which expresses very well), in order to pursue the neutron structure.

It was determined that BcII does not grow mm-size crystals using the vapor-diffusion method in 9-well plates and 0.5–1 ml drops. Instead, large BcII crystals grow using dialysis method, using commercially available dialysis buttons with 3,000-Da cutoff membrane. BcII crystals are prone to degradation through oxidation of residue Cys221 upon long incubation times (weeks to months). Since neutron beamtime is scarce, BcII crystals will need to be freshly grown close to the data collection time. I plan to grow mm-size BcII crystals for the upcoming neutron beam cycle starting in October 2014, for which the corresponding beamtime request application has been submitted and is pending approval.

Mechanism of substrate binding

For the reasons outlined above, this research is also focused on BcII. Two double mutants were designed,

cloned, purified, crystallized, and their structures were solved through x-ray crystallography, namely, BcII-DDE (Cys221Asp, His263Glu) and BcII-DDQ (Cys221Asp, His263Gln). As expected, both display an empty second-zinc site and no β -lactamase activity. The next step is to co-crystallize these mutants with different metals and intact β -lactam antibiotics. Crystals have already been grown in the presence of ampicillin and different concentrations of Zn²⁺ (as a negative control), Ca²⁺, Mg²⁺, Sr²⁺, Ba²⁺, Fe³⁺, Co²⁺, Mn²⁺, Ni²⁺, Cu²⁺, Al³⁺, and Sm³⁺, in order to screen conditions in which these metals would enable substrate binding but no catalysis. These crystals will be flash-frozen and shipped to the Stanford Synchrotron Radiation Lightsource (SSRL) for x-ray data collection, for which I have been awarded beamtime on July 8-9th, proposal SSRL 4B25A.

Inhibition of MBLs

This part of the project is focused on two families of potential inhibitors: sulfonamides and bisthiazolidines. The sulfonamides 3-[(2-oxo-1,3-oxazolidin-3-yl)carbonyl]-2-pyridinesulfonamide (OCPS), 6-methoxy-3-nitro-2-pyridinesulfonamide (MNPS) and 3-(4-methyl-5-oxo-4,5-dihydro-1,3,4-oxadiazol-2-yl)-2-pyridinesulfonamide (DOPS) are commercially available and were selected based on their central 2-pyridine sulfonamide moiety. These compounds have the potential to bind to the second-zinc of MBLs thereby inhibiting the enzyme competitively (through preventing substrate binding) or uncompetitively (through removing the second-site zinc). As a proof-of-concept, the structure of BcII complexed with 2-pyridine sulfonamide was solved at pH 6, showing the expected binding mode, i.e. bidentate binding to the second-zinc site through nitrogen atoms present in the probably deprotonated sulfonamide -NH₂ and the pyrimidine. Crystallization trials are in progress for BcII complexed with compounds OCPS, MNPS and DOPS. These crystals will also be shipped and data collected in the upcoming trip to SSRL.

The second group of compounds, bisthiazolidines (BTZs), are bicyclic heterocyclic compounds with two fused thiazolidine rings, thereby emulating penicillins. These compounds were obtained through a collaborative work with researchers from Uruguay and Argentina, who synthesized and isolated them. I have solved the x-ray structures of BcII complexed with three of them (CS319, GM256 and VC26), and measured their inhibition constants in vitro, which resulted to be in the micromolar range. These structures have shed light on possible modifications leading to improved inhibiting properties in these compounds, particularly VC26, which are being introduced by our collaborators in Uruguay.

Most of the inhibition results were presented as a poster in this year's LANL Postdoc Research Day, and as an oral presentation in the 2014 American Crystallographic Association Annual meeting.

Future Work

In FY13 the project has been re-scoped to reduce security and safety risks. Instead of enzyme evolution for monobactam resistance, the final part of the project now focuses on characterizing interactions of BcII enzyme with potential inhibitors on a path to rational inhibitor design. The re-scoped project has obtained IBC approval (IBC-127-2013).

In the remaining few months of the project, the following task will be accomplished:

Crystals of two double mutants of BcII metallo- β -lactamase have already been grown in the presence of ampicillin and different concentrations of Zn²⁺ (as a negative control), Ca²⁺, Mg²⁺, Sr²⁺, Ba²⁺, Fe³⁺, Co²⁺, Mn²⁺, Ni²⁺, Cu²⁺, Al³⁺, and Sm³⁺, in order to screen conditions in which these metals would enable substrate binding but no catalysis. These crystals will be flash-frozen and shipped to the Stanford Synchrotron Radiation Lightsource (SSRL) for x-ray data collection. Subsequently, the structures of the enzyme in the presence of various metals and ampicillin will be solved to shed light on the structure of enzyme-substrate complex.

As a proof-of-concept, the structure of BcII complexed with 2-pyridine sulfonamide was solved at pH 6, showing the expected binding mode, i.e. bidentate binding to the second-zinc site through nitrogen atoms present in the probably deprotonated sulfonamide -NH₂ and the pyrimidine. Crystallization trials are in progress for BcII complexed with three additional sulfonamides containing 2-pyridine sulfonamide core with different modifying groups. Structures for these crystals will also be solved. BcII metallo- β -lactamase inhibition by the three additional sulfonamides will also be characterized in vitro.

As a final task, large crystals of BcII enzyme will be grown and neutron diffraction data will be collected at Lujan Center in the upcoming beam cycle starting in October. Neutron structure of the enzyme will be solved revealing water molecules and their possible role in binding and catalysis.

Conclusion

We will characterize the enzymes NDM-1 and BcII: (1) Water activation, (2) Substrate binding, (3) Inhibition (1) we will solve the structure of NDM-1 through neutron crystallography, which will shed light on the H-bond networks in

the active site. (2) we will engineer NDM-1 to enable binding alkali earth metals in the second Zn(II) site. This will eliminate enzyme activity while retaining substrate binding for structural analysis. (3) We will investigate structures of BclI enzyme with potential inhibitors bound to get information needed for rational inhibitor design.

Publications

Gonzalez, J. M., M. M. Gonzalez, M. Kosmopoulou, C. Saiz, V. Castillo, G. Mahler, R. Bonomo, J. Spencer, and A. J. Vila. Inhibition of Metallo- β -Lactamases by Bisthiazolidines. . Presented at 2014 American Crystallographic Association Annual Meeting. (Albuquerque, 24-28 May 2014).

John, F. J. St, D. Dietrich, C. Crooks, E. Pozharski, J. M. Gonzalez, E. Bales, K. Smith, and J. C. Hurlbert. A Novel Member of Glycoside Hydrolase Family 30 Subfamily 8 with Altered Substrate Specificity. To appear in *Acta Crystallographica Section D*.

Marti-Arbona, R., J. M. Gonzalez, and C. J. Unkefer. Crystal Structure of Phosphoenolpyruvate Carboxylase from *Methylobacterium extorquens*. Presented at 2014 American Crystallographic Association Annual Meeting. (Albuquerque, 24-28 May 2014).

Turra, G., C. Faugel, J. M. Gonzalez, D. Presello, C. Andreo, and V. Campos-Bermudez. La glioxalasa I de maíz regula niveles de metilglioxal, una molécula señal de estrés en *Fusarium verticilloides*?. Presented at XXX Argentine Meeting of Plant Physiology. (Mar del Plata, Argentina, 21-24 September 2014).

Unkefer, C. J., J. Chen, S. Z. Fisher, J. M. Gonzalez, J. P. Bacik, and M. J. Waltman. Time-of-flight Laue Neutron Crystallography at the Protein Crystallography Station (PCS) at LANSCE. . Presented at 2014 American Crystallographic Association Annual Meeting. (Albuquerque, 24-28 May 2014).

Stimuli Responsive, Functional Biopolymers: Quinic Acid-Based Polymers and Their Assemblies

Hsing-Lin Wang
20130778PRD1

Introduction

This project aims to develop functional biomolecules with emergent (mechanical, optical, and electronic) properties that are not accessible through conventional synthetic methods. The approach uses molecules that are known to form polymers compatible with biological systems with side chains that are active to which functional groups can be attached. Depending on the distribution and density of these functional groups on the side chains, a wide spectrum of mechanical and optical properties, and electronic structures can be accessed. Our goal is to exploit the emergent properties, and through the analysis of structure-property relationships, obtain valuable insight regarding the design of biopolymers with enhanced functionality that can be used toward sensing, bioimaging, drug delivery, optical, electronic and energy applications. Such an approach has not yet been studied in a systematic manner mainly because multidisciplinary knowledge ranging from organic synthesis to materials chemistry to biochemistry is needed.

The challenge is to develop synthetic chemistry routes that are facile and effective. Further, we must control the distribution of functional groups on the side chains in order to render desired properties. Dr. Pradeep Cheruku is a researcher who has the unique combination of skills and knowledge to execute the project and offers the best opportunity for success.

Benefit to National Security Missions

We expect that these new classes of biopolymers may exhibit high temperature thermal transitions and strong mechanical properties due to the high degree of hydrogen bonding and rigid carbocyclic backbone. We hope to show the correlation between nanoassembly structures and their associated properties to obtain valuable insights on the interplay between structure, dynamics and functions of the materials. We also expect to develop

novel strategies for the design and synthesis of nanoassemblies with adaptive control to enable the materials with immense technological relevance in areas of optics, electronics, photovoltaic, and biomedical devices that impact our missions in energy security and threat reduction.

Progress

Synthesis and characterization of nonnatural fluorescent amino acid and their applications toward bioimaging

We have synthesized a series of fluorescent unnatural amino acids (UAAs) bearing stilbene and meta-phenylenevinylene (m-PPV) backbone and their optical properties were studied using a suite of spectroscopy probes. These novel amino acids were derived from protected diiodo-L-tyrosine using palladium-catalyzed heck couplings with a series of styrene analog. Unlike the other fluorescent UAAs, whose emissions are restricted to a narrow range of wavelengths, these new amino acids display the emission peaks at broad range wavelengths (from 400-800 nm); including NIR with QY of 4% in HEPES buffer. The incorporation of both pyridine and phenol functional groups lead to distinct red, green, and blue (RGB) emission, in its basic, acidic and neutral states, respectively. More importantly, these amino acids showed reversible pH and redox response showing their promise as stimuli responsive fluorescent probes. To further demonstrate the utility of these UAAs in peptide synthesis, one of the amino acids in this series was incorporated into a cell penetrating peptide (CPP) sequence through standard solid phase peptide synthesis. The general use of these UAAs for cell imaging has been demonstrated by applying CPP to two different cell lines using confocal fluorescence microscopy.

Water-soluble biopolymer for bioimaging

Water-soluble cationic conjugated polymers (WSCPs) show stronger affinity toward the negatively charged

cell membranes, staining cell surface using WSCPs is a relatively unexplored area due to the endocytosis problem. However, the ability to functionalize these polymers with specific recognition ligands enables selective detection among the various cell lines and different organelles. To date, only one report has appeared in literature disclosing the ability of WSCPs to be stable cell staining agents. Water soluble polythiophene polymer conjugated with lapatinib, an anticancer tyrosine kinase inhibitor, can be used to induce the polymer interaction with transmembrane proteins and thus achieve the stable cell membrane staining.

Cell membrane staining using WSCPs without any targeting ligands for bio recognition is not known. We have shown very exciting results using cationic poly(p- phenylene vinylene) (PPV), a WSCP for cell imaging. P2 as bioimaging polymer exhibits stability allowing long-term cell tracking, distinguishing live and dead cells, and multi- functional cell staining. Overall, our results show that using WSCP is far superior than state-of-the-art staining commercial dyes as WSCP has a much faster staining time at a much lower cost (100 times cheaper than existing commercial dye), while providing more details and imaging resolution as opposed to the commercial dyes. Such unprecedented properties suggest that certain WSCPs may serve as next generation imaging dyes for biomedical research.

Future Work

During the next fiscal year, we will perform synthesis and characterization of a series of unnatural amino acids (UAA) consisting of conjugated oligomers which can be incorporated into the biopolymers (peptides). These novel amino acids will be derived from protected diiodo-L-tyrosine using palladium-catalyzed heck couplings with a structure similar to the styrene analog. Unlike the other fluorescent UAAs, whose emissions are restricted to a narrow range of wavelengths, our UAAs are expected to display the emission peaks at broad range wavelengths (from 400-800 nm); including NIR.

Conclusion

We expect synthesis of a new class of biopolymers with thermal transitions and strong mechanical properties due to the high degree of hydrogen bonding and rigid carbocyclic backbone. We hope to show the correlation between nanoassembly structures and their associated properties to obtain valuable insights on the interplay between structure, dynamics and functions of the materials. We also expect to develop novel strategies for the design and synthesis of nanoassemblies with adaptive control to enable materials with immense technological relevance in areas of optics, electronics, photovoltaic, and biomedical

devices that impact our missions in energy security and threat reduction.

Publications

- Cheruku, P., J. H. Huang , H. J. Yen, R. S. Iyer,, Kirk D. Rector, J. S. Martinez, and H. L. Wang. Tyrosine-derived stimuli responsive, fluorescent amino acids . 2015. CHEMICAL SCIENCE. 6: 1150.
- Park, Y. I., O. Postupna, A. Zhugayevych, H. Shin, Y. -S. Park, B. Kim, H. -J. Yen, P. Cheruku, J. S. Martinez, J. W. Park, S. Tretiak , and H. -L. Wang. A new pH sensitive fluorescent and white light emissive material through controlled intermolecular charge transfer. 2014. CHEMICAL SCIENCE. : DOI: 10.1039/C4SC01911C.

Single Cell Genomics for Better Control of Plant Pathogens

Shunsheng Han
20130779PRD1

Introduction

The proposed research will use the rhizosphere-colonizing bacterium *Pseudomonas chlororaphis* strain 30-84. The strain is able to inhibit fungal pathogens and has become a model for a beneficial commensal bacterium. This strain demonstrates phenotypic variation resulting from spontaneous mutations. The goal of this research is to identify signature genomic and transcriptomic changes in response to environmental signals and investigate how these changes benefit the wild type populations using a plant associated bacterial as example.

Benefit to National Security Missions

The understanding of the relationship between plant and bacteria is directly linked to the DOE mission in the area of bioenergy. LANL, supported by DOE, has invested significantly in studying plant metabolism and algal biofuel. This work will enrich our portfolio in these areas and bridge the gaps between environmental microbiology and plant study.

Progress

The project seeks to understand microbial evolution at both genomic and transcriptomic levels. Specifically, we performed genome and RNA sequencing analysis of the biological strain *Pseudomonas chlororaphis* 30-84 and a spontaneous small colony (SCV) mutant derivative. Phenotypically, the SCV exhibited small cell size, decreased antibiotic production, reduced motility, but increased biofilm formation. Whole-genome sequence analysis (done in the Bioscience Division at LANL) identified the deletion of a 70 Kb genomic island and mutations in *yfiR* (cyclic-di-GMP production), *cyoE* (heme synthesis) as well as *fusA* (elongation factor) in the SCV mutant. Further genetic analysis (done at Texas A&M University, in collaboration with my previous advisors) revealed that the *yfiR* locus plays a major role in controlling colony size, growth, motility and biofilm formation. Moreover, point mutation in the *fusA* gene partially contributed to

kanamycin resistance. Transcriptomic profiling indicated that 1,098 genes (18.4%) have undergone substantial reprogramming of gene expression in the SCV mutant. These data have been summarized in a manuscript entitled "Adaptation genomics of a small colony variant (SCV) in the biofilm of *Pseudomonas chlororaphis* 30-84" which was submitted to the *Journal Applied Environmental Microbiology*, the #1 cited journal in microbiology.

I also sequenced two wheat-seed associated bacteria (done at LANL). The strains *Pseudomonas putida* S610 and *Enterobacter cloacae* S611 are strong colonizers of wheat rhizosphere and have potential in biological control applications. The genome sequences for both strains were available at National Center for Biotechnology Information (NCBI). The genome of *P. putida* S610 was also announced by the journal *Genome Announcement*.

I recently established international collaborations with researchers at Jilin University, China. The collaboration resulted in a publication on a stress-inducible maize promoter by the journal *Plant Molecular Biology Reporter*. We also plan to sequence 3 highly effective pesticide degrading bacteria.

On going projects

The SCV mutant can phenotypically switch back to the wild type morphology under specific conditions. The revertant strains showed similar growing characteristic, motility and biofilm formation to the wild type strain. We are currently characterizing the revertant strain using genomic and genetics approaches. To our best knowledge, this is the first genome-wide analysis of a bacterial phenotypic switching event. Our data will significantly enhance our understanding of bacterial adaptations to stress conditions in nature.

We are working on a USDA permit to receive biological control strains from Jilin University. Genome sequences of these pesticide degrading bacteria will laid a solid

foundation to further explore the pesticide degrading mechanisms.

Future Work

We are currently characterizing the revertant strain using genomic and genetics approaches. The spontaneous small colony (SCV) mutant can phenotypically switch back to the wild type morphology under specific conditions. The revertant strains showed similar growing characteristic, motility and biofilm formation to the wild type strain. To the best of our knowledge, this is the first genome-wide analysis of a bacterial phenotypic switching event. Our data will significantly enhance our understanding of bacterial adaptations to stress conditions in nature.

We are working on a USDA permit to receive biological control strains from Jilin University. Genome sequences of these pesticide degrading bacteria will lay a solid foundation to further explore the pesticide degrading mechanisms.

Conclusion

We expect to identify mutational events during *P. chlororaphis* colonization, to classify and identify the beneficial mutation that are involved in host association. We will also identify the role of these genomic changes in bacterial persistence. Understanding of molecular processes involved in bacterial adaptation could lead to better disease management strategies.

Publications

Sun, G., J. Liu, G. Li, X. Zhang, J. Chen, T. Chen, H. Zhang, D. Wang, F. Sun, and H. Pan. Quick and accurate detection and quantification of *Magnaporthe oryzae* in rice using Real-Time Quantitative Polymerase Chain Reaction. To appear in *Plant Disease*.

Tao, Y., F. Wang, D. Jia, J. Li, Y. Zhang, C. Jia, D. Wang, and H. Pan. Cloning and functional analysis of the promoter of a stress-inducible gene (*ZmRXO1*) in maize. 2014. *Plant Molecular Biology Reporter*. : 1.

Wang, D., J. M. Yu, R. J. Dorosky, L. S. III Peirson, and E. A. Pierson. The Phenazine 2-hydroxy-phenazine-1-carboxylic acid promotes extracellular DNA release and has broad transcriptomic consequences in *Pseudomonas chlororaphis* 30-84. *Molecular Plant-Microbe Interactions*.

Wang, D., R. J. Dorosky, C. Han, C. H. Lo, A. Dichosa, P. Chain, J. M. Yu, L. S. III Pierson, and E. A. Pierson. Genomic adaptations of a small colony variant in the biofilm of *Pseudomonas chlororaphis* 30-84. To appear in *Applied Environmental Microbiology*.

Exploring Doubly Parasitic Radioisotope Production Via Secondary Neutron Fluence From the 100 MeV IPF Irradiations

Eva R. Birnbaum
20130782PRD2

Introduction

The Isotope Production Facility (IPF) at Los Alamos National Laboratory (LANL) produces the radioactive isotopes strontium-82 and germanium-68 for use in medical imaging. The IPF's high proton beam current and lengthy irradiations produce a secondary neutron field with a utilitarian scale that is beyond the reach of medical cyclotrons and energetically distinct from reactor neutron fluences. There are currently no large facilities in the United States with access to such a significant, high-energy neutron flux, yet IPF secondary neutrons' potential for research in novel methods of isotope production and materials science remains unexploited. These radioisotopes are necessary to a variety of scientific and medical fields, and in many cases the stability of future uninterrupted supply is uncertain. Additionally, LANL's globally recognized expertise in the characterization and handling of radioisotopically and chemically diverse products of fast neutron irradiations is uniquely capable of facilitating such an exploration.

Current two week irradiations produce several tera-neutrons per second, approaching the scale of medium-sized research reactors. The Monte Carlo N-Particle eXtended (MCNPX) code, developed at LANL, has been used to simulate the secondary neutron field and optimize the design of research targets that can confirm predictions about the size and character of this neutron flux. Using these simulations, special activation foils have been introduced into the neutron field and the radioisotope products of neutron-initiated reactions. Once computational predictions have been confirmed by experiment, MCNPX codes will be further used to design future experiments in materials science development and to produce radioisotopes in the service of the larger scientific community.

Delivery of these and other isotopes whose study is proposed makes possible targeted radiotherapy for cancer patients, experiments in solid-state physics, diagnosis

of a wide range of pathologies, and the development of improved materials for civil and scientific purposes.

Benefit to National Security Missions

A comprehensive understanding of the secondary neutron flux at the Isotope Production Facility will expand the capabilities of the Isotope Program to study and produce a broader suite of isotopes for medical, national security, and basic science applications. Studies will also improve nuclear models and provide an avenue for study of materials under extreme environments.

Progress

Worked with Mike James (NEN-5), Stepan Mashnik (XCP-3), and others to investigate accuracy of evaluated data libraries and MCNP-implemented physics models, which are applied to the problem of computational predictions of isotope production using the IPF secondary neutron flux. Developed a computational toolkit for prediction of secondary neutron flux effects with respect to isotope production in various materials. Publication: Engle J W, James M R, Mashnik S G, Kelsey C T IV, Wolfsberg L E, Reass D A, Connors M A, Bach H T, Fassbender M E, John K D, Birnbaum E R, Nortier F M (2014). MCNPX characterization of the secondary neutron flux at the Los Alamos Isotope Production Facility. Nuclear Instruments and Methods in Physics Research, Section A. Accepted March 21, 2014.

Tailored the predictions of these models to experimental measurements of activation experiments using test foils and quantification of radioisotopes produced in the foils by neutron-initiated reactions, and applied these results to experimental measurement of the production potential for scandium-47 using enriched titanium (Ti) and vanadium (V) targets. Ti and V were irradiated at IPF and gamma spectroscopy was used to quantify radioactive products and impurities. Supervised a master's student to conduct experiments and data analysis.

Student presented work at the annual Society for Nuclear Medicine and Molecular Imaging meeting in St. Louis, MO: DeLorme, K A, Engle J W, Nortier F M, Birnbaum E R, John K D, Jackman K R, Marus L A, Kowash B R, McHale S, Clinton J C (2014). Production potential of scandium-47 using spallation neutrons at the Los Alamos Isotope Production Facility. Society for Nuclear Medicine and Molecular Imaging Annual Meeting, St. Louis, Missouri, June 8-12.

Finalized analysis of 40 – 200 MeV p + Tb residual cross sections to evaluate the potential for Gd-153 production at IPF. Publication pending completion of the compilation of the data.

Supervised student to characterize the proton beam energy and experimental proton flux measurement assisted by MCNPX predictions in routine high proton intensity irradiations for isotope production and in low-intensity irradiations for nuclear physics measurements. Manuscript in preparation. Work presented at the annual CoDA meeting in Santa Fe, NM: Marus L A, Maassen J R, Fassbender M E, Birnbaum E R, John K D, Engle J W, Nortier F M. Non-destructive proton beam monitoring (2014). Conference on Data Analysis, Santa Fe, New Mexico, March 5 – 7.

Continued to support efforts to produce Ho-163 for neutrino mass measurements (LANL LDRD-funded ER) via proton irradiation at the University of Wisconsin and the Los Alamos Isotope Production Facility. Abstracts resulting from this effort: Kunde, G J, Engle J W, Nortier F M, Birnbaum E R, Taylor W A, Mocko V, Croce M P, Hoover A S, Rabin M W. Transition edge sensor electron capture spectroscopy (2014). Symposium on Radiation Measurements and Applications (SORMA XV), June 9 – 12, Ann Arbor, Michigan, USA. Mocko V, Taylor W A, Nortier F M, Engle J W, Barnhart T E, Nickles R J, Rabin M W, Birnbaum E R (2014). Isolation of Ho-163 from Dy target material by HPLC for neutrino mass measurements. 17th Radiochemical Conference Book of Abstracts, Prague, the Czech Republic, May 11-16, SEP-V18 (Id: 141) p298.

Future Work

Utilize the developed toolkit for prediction of the effects of the secondary neutron flux to initiate use of the flux for isotope production, in particular Si-32 and other isotopes of current interest like Sr-90. Investigate the applicability of the secondary neutron flux to other large-scale international facilities with respect to the production of useful radioisotopes, in particular spallation neutron sources (e.g., ESS) and conversion target neutron sources (e.g., JPARC). Continue investigation of IPF's potential for contribution to fusion energy research program through testing of tritium breeding, chemical separation and migration through test

materials. If funding for students and/or research activities can be obtained, supervise expansion of aims to include the collection of nuclear excitation functions for fast-neutron initiated reactions. In particular, investigate the activation of samples of Ra-226 in the IPF secondary neutron flux for the simultaneous co-production of several actinide isotopes of interest to medical radiotherapy (e.g., Ac-225, Th-227 and Ac-227).

Continue spectroscopic analysis of 40 - 800 MeV p + Tm, Cu, V irradiation foils to calculate nuclear formation cross sections. Apply these cross sections to the evaluation of spallation-regime isotope production schemes.

Publish results pending publication of student work characterizing proton beam energy and flux determination during cross section measurements at LANL.

Complete publication of 40 – 800 MeV p + Th target residual cross sections.

Continue contributions in Rb metal targetry, production of Ho-163 for neutrino mass measurement, and supervision of students interested in radioisotope production using the IPF. Work towards identification and development of collaborative research efforts in the biological application of radioisotopes to the treatment of human disease within and without LANL.

Conclusion

The goal of this project is to elucidate a more complete understanding of the secondary neutron flux at the Isotope Production Facility. These experiments will define production methodologies that will supply radioisotopes on the cutting edge of research in several fields. Production of isotopes including scandium-47, actinium-225, and radium-225 for medical radioimmunotherapy will be investigated. The neutron flux can also be used to study the effects of high radiation environments and thus fuel development of materials and devices that can withstand the extreme conditions in space or power production devices such as fusion reactors.

Publications

Delorme, K. A., J. W. Engle, F. M. Nortier, E. R. Birnbaum, and B. R. Kowash. Production potential of Sc-47 using spallation neutrons at the Los Alamos Isotope Production Facility. Presented at Society of Nuclear Medicine and Molecular Imaging. (St. Louis, MO, 7-11 Aug. 2014).

Engle, J. W., C. T. Kelsey, Bach, B. D. Ballard, M. E. Fassbender, K. D. John, E. R. Birnbaum, and F.

- M. Nortier. Preliminary Investigation of Parasitic Radioisotope Production Using the LANL IPF Secondary Neutron Flux. 2012. 14TH INTERNATIONAL WORKSHOP ON TARGETRY AND TARGET CHEMISTRY. 1509: 171.
- Engle, J. W., C. T. Kelsey, H. Bach, B. D. Ballard, M. E. Fassbender, K. D. John, E. R. Birnbaum, and F. M. Nortier. Preliminary investigation of parasitic radioisotope production using the LANL IPF secondary neutron flux. 2012. In 14th International Workshop on Targetry and Target Chemistry. (Cancun, Mexico, 26-29 Aug. 2012). Vol. 1, 1 Edition, p. 1. New York: American Institute of Physics.
- Engle, J. W., E. R. Birnbaum, F. M. Nortier, J. A. Rau, K. D. John, and H. R. Trellue. Purification of (PU)-P-242 by irradiation with thermal neutrons. 2013. NUCLEAR INSTRUMENTS & METHODS IN PHYSICS RESEARCH SECTION B-BEAM INTERACTIONS WITH MATERIALS AND ATOMS. 298: 70.
- Engle, J. W., E. R. Birnbaum, F. M. Nortier, J. A. Rau, K. D. John, and H. R. Trellue. Purification of (PU)-P-242 by irradiation with thermal neutrons. 2013. NUCLEAR INSTRUMENTS & METHODS IN PHYSICS RESEARCH SECTION B-BEAM INTERACTIONS WITH MATERIALS AND ATOMS. 298: 70.
- Engle, J. W., E. R. Birnbaum, H. R. Trellue, K. D. John, M. W. Rabin, and F. M. Nortier. Evaluation of Ho-163 production options for neutrino mass measurements with microcalorimeter detectors. 2013. NUCLEAR INSTRUMENTS & METHODS IN PHYSICS RESEARCH SECTION B-BEAM INTERACTIONS WITH MATERIALS AND ATOMS. 311: 131.
- Engle, J. W., E. R. Birnbaum, H. R. Trellue, K. D. John, M. W. Rabin, and F. M. Nortier. Evaluation of Ho-163 production options for neutrino mass measurements with microcalorimeter detectors. 2013. NUCLEAR INSTRUMENTS & METHODS IN PHYSICS RESEARCH SECTION B-BEAM INTERACTIONS WITH MATERIALS AND ATOMS. 311: 131.
- Engle, J. W., J. W. Weidner, B. D. Ballard, M. E. Fassbender, L. A. Hudston, K. R. Jackman, D. E. Dry, L. E. Wolfsberg, L. J. Bitteker, J. L. Ullmann, M. S. Gulley, Pillai, Goff, E. R. Birnbaum, K. D. John, S. G. Mashnik, and F. M. Nortier. Ac, La, and Ce radioimpurities in Ac-225 produced in 40-200 MeV proton irradiations of thorium. 2014. RADIOCHIMICA ACTA. 102 (7): 569.
- Engle, J. W., M. R. James, S. G. Mashnik, C. T. Kelsey, L. E. Wolfsberg, D. A. Reass, M. A. Connors, H. T. Bach, M. E. Fassbender, K. D. John, E. R. Birnbaum, and F. M. Nortier. MCNPX characterization of the secondary neutron flux at the Los Alamos Isotope Production Facility. 2014. NUCLEAR INSTRUMENTS & METHODS IN PHYSICS RESEARCH SECTION A-ACCELERATORS SPECTROMETERS DETECTORS AND ASSOCIATED EQUIPMENT. 754: 71.
- Engle, J. W., S. G. Mashnik, Bach, Couture, Jackman, Gritz, B. D. Ballard, Fassbender, D. M. Smith, L. J. Bitteker, J. L. Ullmann, M. S. Gulley, Pillai, K. D. John, E. R. Birnbaum, and F. M. Nortier. Cross sections from 800 MeV proton irradiation of terbium. 2012. NUCLEAR PHYSICS A. 893: 87.
- Engle, J. W., S. G. Mashnik, J. W. Weidner, L. E. Wolfsberg, M. E. Fassbender, Jackman, Couture, L. J. Bitteker, J. L. Ullmann, M. S. Gulley, Pillai, K. D. John, E. R. Birnbaum, and F. M. Nortier. Cross sections from proton irradiation of thorium at 800 MeV. 2013. PHYSICAL REVIEW C. 88 (1).
- Engle, J. W., S. G. Mashnik, J. W. Weidner, L. E. Wolfsberg, M. E. Fassbender, K. Jackman, A. Couture, L. J. Bitteker, J. L. Ullmann, M. S. Gulley, C. Pillai, K. D. John, E. R. Birnbaum, and F. M. Nortier. Cross sections from proton irradiation of thorium at 800 MeV. 2013. PHYSICAL REVIEW C. 88 (1): -.
- Fassbender, M. E., Ballard, E. R. Birnbaum, J. W. Engle, K. D. John, J. R. Maassen, F. M. Nortier, J. W. Lenz, C. S. Cutler, A. R. Ketrings, S. S. Jurisson, and D. S. Wilbur. Proton irradiation parameters and chemical separation procedure for the bulk production of high-specific-activity Re-186g using WO₃ targets. 2013. RADIOCHIMICA ACTA. 101 (5): 339.
- Gott, M. D., B. D. Ballard, L. N. Redman, J. R. Maassen, W. A. Taylor, J. W. Engle, F. M. Nortier, E. R. Birnbaum, K. D. John, D. S. Wilbur, C. S. Cutler, A. R. Ketrings, S. S. Jurisson, and M. E. Fassbender. Radiochemical Study of Re/W Adsorption Behavior on a Strongly Basic Anion Exchange Resin. 2014. RADIOCHIMICA ACTA. 102 (4): 325.
- Jackman, K. R., J. W. Engle, F. M. Nortier, K. D. John, E. R. Birnbaum, and D. E. Norman. Synthetic spectra for radioactive strontium production QA/QC. 2014. JOURNAL OF RADIOANALYTICAL AND NUCLEAR CHEMISTRY. 302 (1): 347.
- Medvedev, D. G., J. W. Engle, F. M. Nortier, S. V. Smith, and L. F. Mausner. Theoretical approach to the production of Ti-44 (T-1/2=59.1 years) using high energy protons: Expanding Sc-44 availability. 2013. ABSTRACTS OF PAPERS OF THE AMERICAN CHEMICAL SOCIETY. 245.

Hybrid Nanostructures for Photoreduction of CO₂ to Hydrocarbons

Hongwu Xu

20130787PRD2

Introduction

The goal of this research is to develop novel hybrid nanostructures for photocatalytic conversion of carbon dioxide plus water into hydrocarbons. Semiconductor-based nanomaterials are promising materials that may enable this catalytic process, as they can couple single photon events with accumulation of multiple redox equivalents upon CO₂ reduction. However, most of the nanomaterials studied are single-component systems, and their conversion efficiencies are too low for practical application. In addition, these nanoparticles often suffer from instability due to light-induced anodic oxidation in aqueous solutions. Hybrid nanostructures composed of core/shell nanoparticles may have effectively separated charges and catalytic sites for enhanced conversion and also possess good stability at relevant conditions.

The core/shell nanoparticles contain a semiconductor core and a metal oxide shell, linked to a nanoparticle catalyst. An example is ZnTe/ZnO core/shell linked to Pt. The core/shell nanostructure serves for initial photo-induced charge separation, while the metallic component provides catalytic sites for subsequent chemical conversion. We will take the advantage of high reducing ability of photo-generated electrons in the semiconductor core to produce high hydrocarbons in high yields. Coating the nanoparticle surface with a metal oxide shell not only protects the nanoparticle from dissolution during the photoreaction, but also facilitates charge separation by forming a barrier for controlled back electron transfer.

This project represents cutting edge R&D with high potential science and promise for practical applications. The project involves controllable synthesis of hybrid nanostructures with wet-chemical methods, followed by characterization of their structures, morphology and compositions using XRD, SEM, and TEM. The charge separation and transfer properties will be measured by transient visible-pump/visible probe, and photoreduction of CO₂ with a photo-electrochemical system. The

goal is to determine the synthesis-structure-property relations, which will then be fed back to the design of new nanostructures with enhanced properties.

Benefit to National Security Missions

This project represents a research topic with great scientific value and tremendous potential for technological applications. Through controllable synthesis and systematic characterization of core/shell nanomaterials, the research is expected to lead to design and development of a novel class of hybrid nanostructures for efficient photocatalytic conversion of carbon dioxide plus water into hydrocarbon fuels and chemicals. The synthesis-structure-property-stability relationship to be determined in this research will lay the foundation for the ultimate development of solar-to-fuel conversion devices and have broad implications for rational design of functional materials in general. This project is tied to missions in DOE office of science, fossil energy and renewable energy as well as NSF, and to LANL's Materials Grand Challenge in the central themes of defects/interfaces and emergent phenomena.

Progress

Mechanism study of controlling ZnTe nanocrystal growth in solution

Magic sized nanoclusters have been found to play an important role in evolution and shape control of ZnTe nanocrystals. Three families of ZnTe magic-sized nanoclusters (MSNCs) were obtained exclusively with high yields using poly-tellurides as a tellurium precursor in one-pot reactions by varying the reaction temperature and time. These ZnTe MSNCs exhibit different self-assembly or aggregation behavior while forming hierarchical structures with the presence of excessive oleylamine, owing to different structures, cluster sizes, and dipole-dipole interactions. The smallest ZnTe MSNCs (F323) possessed a non-crystalline structure and were as-

sembled into lamellar triangle plates. Continuous heating of as synthesized ZnTe F323 assemblies resulted in transition into lamellar rectangle assemblies of ZnTe F398 MSNCs with the wurzite structure and organization of nanoclusters along $\langle 002 \rangle$ direction. Further annealing of ZnTe F398 assembled lamellar rectangles led to formation of larger ZnTe F444 NCs, which spontaneously formed into ultrathin nanowires through orientated attachment. Controlling the growth pattern of ZnTe F398 NCs - namely step growth and continuous growth was found playing an important role in determining the diameter distribution of ZnTe ultrathin nanowires. Phase transition was also an important factor in determining the MSNCs morphology during the growth of F398 MSNCs. Transient absorption (TA) measurements show that all the three families possess ultra-fast dynamics of photo generated electrons, in spite of their different crystalline structures.

Synthesis of ZnTe/CdS-Pt core/shell nanostructures

The three component nanostructure was prepared using a multi-step growth strategy. We first developed a synthetic method for ZnTe nanocrystals with the ability of fine tuning the morphology and phase. Then, ZnTe/CdS-Pt core/shell nanorods were synthesized using a successive growth method in organic solution. The morphology, structure, and chemical composition can be easily adjusted by tuning the reaction parameters. For example, the width and length of nanorods were controlled by varying reaction temperature and time, respectively, and the core/shell thickness ratio was controlled by changing precursor input amounts.

Spectroscopic study of charge dynamics in ZnTe nanostructures

The ultrafast internal and external charge separation dynamics in ZnTe/CdSe core/shell type II nanostructures have been studied through femtosecond transient absorption spectroscopy. The internal electron transfer time from a ZnTe core to a CdSe shell was found to be 0.67 ps, while the external electron transfer time from QDs to adsorbed molecules was found to be <0.2 ps. Such a fast external charge separation time is due to the extraordinarily high conduction band energy potential of ZnTe. The results indicate the preservation of high photo-driven reductive abilities in the ZnTe/CdSe core/shell type II heterostructures and strongly support the use of ZnTe nanomaterials for photocatalysis in CO₂ reduction.

Future Work

In FY2015, we will first optimize the synthetic procedures for ZnTe/CdS-Pt hybrid nanostructures with fine control over their nanoparticle sizes, shapes, and crystallinity. Then, we will modify the surfaces of the hybrid nanostructures

using a ligand changing strategy and establish a facial method to transfer the nanomaterials from the organic to water solution, while maintaining their properties of ultrafast charge transfer dynamics. The structure, morphology and composition of the obtained nanostructures will be characterized using synchrotron X-ray diffraction, differential scanning calorimetry, scanning and transmission electron microscopy. The photoreduction of CO₂ will be performed by using a gas-tight reaction cell containing the photocatalyst solutions. The photocatalytic performance will be evaluated by monitoring the concentration of product using a gas chromatograph. The mechanism of the photoreaction will be studied by monitoring intermediate radical species using EPR. The results of the mechanism studies will be incorporated into the design and synthesis of new photocatalysts with enhanced performance. In addition, we will continue to investigate the growth processes/mechanisms of ZnTE magic-sized nanoclusters, which eventually lead to ZnTe nanocrystal formation, using a newly developed reaction vessel, in combination with synchrotron X-ray small-angle and wide-angle scattering at CHESS. We anticipate publishing 2-3 peer-reviewed papers in high-profile journals.

Conclusion

Successful execution of this research will lead to design and development of a novel class of hybrid nanostructures for efficient photocatalytic conversion of carbon dioxide plus water into hydrocarbon fuels and chemicals. Through controllable synthesis and systematic characterization of the core/shell nanostructures, we will determine the synthesis-structure-property-stability relationship for this family of nanomaterials, which have implications for rational design of functional materials in general. The obtained results will lay the foundation for development of solar-to-fuel conversion devices and directly address LANL/DOE's grand challenges in energy and environmental materials research.

Complex Natural & Engineered Systems

Postdoctoral Research and Development
Continuing Project

Joint Inversions of Seismic and Gravity Data in Volcanic Areas to Advance Hazards Assessment: A Focus on the Alaskan Subduction Zone and Kilauea, Hawaii

Monica Maceira
20130807PRD3

Introduction

Three-dimensional passive-source seismic velocity tomography is a powerful technique that utilizes energy produced by earthquakes to image potentially complex subsurface structures, such as magma distributions beneath volcanoes or subducting slabs. However, the resolution of these studies are generally limited by the natural distribution of earthquakes. While active sources can expand coverage, they are generally only used to image the upper crust and are costly. Gravity data, however, provide alternate sources of information regarding subsurface structures, and are available at a variety of scales. Due to the inherent relationship between density and seismic velocity, gravity and seismic data can be jointly inverted, providing an understanding of Earth structures that is not limited by the distributions of seismicity and has stronger constraints on the temperature, compositional, fluid, and magmatic distributions in a study area.

The current distribution of seismic stations in Alaska is focused near the relatively two-dimensional volcanic arc located above the subducting oceanic plate, limiting the ability to resolve its seismic structure. The inclusion of gravity data in a joint inversion will markedly increase the ability to resolve these features in three dimensions. I will address questions regarding the sources of volcanism in the Alaska subduction zone.

Kilauea Volcano presents a unique opportunity to study one of Earth's most active volcanoes, in a location that has produced historical tsunamigenic earthquakes. While previous seismic studies have focused on studying the near-surface beneath the summit caldera, portions of Kilauea's rift zones, or the seismically active tsunamigenic decollement fault beneath the volcanic material and the underlying oceanic crust, the extent of these studies are limited by natural seismic distributions. By combining gravity and seismic data, I will address questions such as "Can the aseismic and seismic portions of

the decollement be imaged, constraining the maximum magnitude of earthquake this fault can produce?"

Benefit to National Security Missions

The proposed research will enhance the capability of the Laboratory through unique expertise in imaging Earth structure. This expertise has applications to Nonproliferation R&D under Nuclear Nonproliferation, where accurate Earth models are needed to locate, identify and determine yield for seismic events of interest such as underground nuclear explosions. The relationship to assessing hazards in volcanic zones could be of interest to DHS/FEMA as they are responsible for domestic preparedness and response regarding, among other things, natural disasters, and perhaps to the Department of the Interior's USGS. High-resolution Earth models are also required for characterization and monitoring within several other areas of LANL mission space including geothermal energy development (Applied Energy Programs Office) carbon sequestration (Fossil Energy, within the Office of Science Programs), and used fuel disposition and salt repository science (both within the office of Civilian Nuclear Programs).

Progress

In her first nine months at the Lab, Ellen has focused on the joint tomographic inversion of datasets from Akutan and Makushin Volcanoes in Alaska and from the Colombian National Seismic Network. This work began with her extending an algorithm that we use for joint inversion, JointTomoFDD, to accept an inversion grid defined in a local Cartesian coordinate system, versus a geographic coordinate system. This extension makes the code more versatile and more compatible with datasets that have been used in older versions of the body wave tomography code tomoDD.

In her work with Akutan and Makushin Volcanoes, she is applying JointTomoFDD to a smaller-scale region than

it has generally been applied previously. In this joint body/surface wave inversion, the body wave arrival times are from Alaska Volcano Observatory. She has derived the surface wave dispersion curves from ambient noise measurements. She has more extensively explored the tradeoffs between the relative weighting of the different data types, as well as regularization, with the intent that these results will help inform others on wise ways to choose input parameters for this algorithm in a more time-efficient way in future studies. The difference in spatial scale of velocity features recovered in the V_p versus the V_s models is helping us better understand how the different data types affect the inversion in a relatively small region. She has not yet added gravity data to the inversion due to additional challenges associated with the size of the region, but she will begin working on this problem soon. In addition to the improved understanding of the methodology coming from this work, the tomographic results are also helping us better understand the geology of these two volcanoes. Combined analysis of the velocity structure at each volcano and the distributions of relocated earthquakes are providing insight to the faulting and possible subsurface magma distributions and pathways. She has presented results from this work at several meetings and is currently writing a manuscript of this work.

Her work on Colombia involves the joint inversion of body waves, surface waves, and gravity data at a national scale. This work is ongoing: she has a high-quality body wave arrival time dataset based on Colombian analyst picks that has been supplemented and refined, she has prepared the gravity dataset, and she is currently in the process of developing the surface wave dataset. She has made surface wave measurements and will soon test a new code that will invert the measurements for a 3D surface wave model, which will be used as input to the joint inversion. Preliminary body-wave inversion results show a sharp discontinuity in slab seismicity separating the northern non-volcanic part of the subduction system from the southern volcanic part. A contrast in seismic velocities associated with the slab at this discontinuity suggests a possible different tectonic source of the northern and southern portions of the slab, which has been an ongoing topic of research for the region. She will present these results for the first time at the International Association of Seismology and Physics of the Earth's Interior (IASPEI) meeting in July.

Ellen has been working with a fellow postdoc (now staff member) at the Lab in his work to improve computational and regularization aspects of joint inversions. While he has a strong background in mathematics and programming, he had never previously worked with passive-source seismic data. Ellen has been working with him to help him better

understand the challenges of our field and identify aspects where he can make a valuable contribution to the community, as well as some of the mechanics of working with the datasets and visualizing results.

Ellen is also helping me – her mentor - with a summer student in her work using seismic data from Bhutan. The student comes to the lab with little experience in seismic research, and Ellen is helping her to conduct a joint tomographic inversion of surface wave and body wave data.

Besides her research, Ellen has participated in several activities at LANL and in the geosciences community. She has convened topical sessions at scientific meetings, peer-reviewed journal articles and NSF proposals; as well as disseminate her work through invited seminars at several institutions.

Future Work

Ellen will simultaneously invert two different data types to derive the Earth's 3D velocity structure beneath the Alaska subduction zone and the Kilauea volcano, Hawaii, as well as the complex subduction zone underneath Colombia. Seismic data will come from local, regional, and national networks and deployments, while gravity data will come from US satellite missions as well as in-land measurements. The research paths will be as follows: (1) develop code for efficient and robust multi-parameter inversion, (2) gather and pre-process the different data types, and (3) perform multi-parameter inversion to produce a validated high resolution high accuracy 3-D velocity image of the Alaska subduction zone, the Kilauea volcano, Hawaii, and the Colombian complex subduction zone. All these three tasks have been initiated during the first year of the project and will be continued and completed by the end of the second year.

Conclusion

The expected results from the research are: I. Development of the next-generation method for imaging the 3-D structure of the Earth and, II. A high-resolution high-accuracy 3-D velocity image of the crust and upper mantle beneath the Alaska subduction zone and the Kilauea volcano, as well as the complex Colombian subduction zone. Ellen is expected to submit two papers to high-impact journals addressing the scientific questions stated in the abstract.

Publications

Lin, Y., E. Syracuse, M. Maceira, C. Larmat, and H. Zhang. Joint inversion for Kilauea volcano with an edge-preserving constraint. 2014. In Seismological Society of America Annual Meeting. (Anchorage, 29 April - 2 May,

2014). Vol. 85, p. 502. El Cerrito: BSSA.

Lin, Y., E. Syracuse, M. Maceira, H. Zhang, and C. Larmat. Double-difference travel-time tomography with edge-preserving regularization and interface prior. To appear in *Geophysical Journal International*.

Syracuse, E., M. Maceira, H. Zhang, and C. Thurber. Seismicity and structure of Akutan and Makushin Volcanoes, Alaska, using joint body- and surface-wave tomography. To appear in *Journal of Geophysical Research*.

Syracuse, E., M. Maceira, and H. Zhang. Joint inversion of seismic and gravity data for velocity structure and hypocentral locations at Akutan and Makushin volcanoes. 2014. In *Seismological Society of America Annual Meeting*. (Anchorage, 30 April - 2 May, 2014). Vol. 85, p. 500. El Cerrito, California: BSSA.

Ultrafast Vacuum Ultraviolet Spectroscopy of Complex Materials

Dmitry A. Yarotski
20130814PRD4

Introduction

Exotic properties of strongly correlated electron materials, such as high-temperature superconductivity and multiferroicity, have inspired an extensive research effort to harness these properties for technological applications. However, the labyrinthine pattern of competing interactions between charge, spin and lattice has prevented the development of predictive theoretical frameworks and establishment of basic material design principles. In general, it is a rather elaborate task for regular time-averaging probes to decipher the nature of the quasiparticles and the interactions involved in collective material behavior because they give little information on the specific degrees of freedom and underlying microscopic physics. In contrast, ultrafast optical spectroscopy offers unsurpassed ability to discriminate the coupling between charge, spin, and lattice in the time domain because their dynamics differ by several orders of magnitude (e.g., tens of picoseconds for phonons vs hundreds of ps for spins).

In this research, we will apply novel ultrafast vacuum ultraviolet photon sources to perform time-resolved X-Ray magnetic linear (and circular) absorption dichroism spectroscopy of a number of strongly correlated electron materials and heterostructures where spin interactions with other degrees of freedom determine material functionality. These techniques will provide new insight into the spin dynamics in these materials with unprecedented time resolution, element specificity, and sensitivity to antiferromagnetic ordering and dynamics near buried interfaces. The results of our advanced characterization effort will directly feedback to the theoretical effort of our colleagues from Theoretical Division. We strongly believe that such a combined ultrafast theory and characterization approach aimed at resolving spin, charge and lattice interactions, as well as the associated quasiparticle dynamics, will ultimately result in a predictive framework for understanding emergent phenomena in strongly correlated electron materials. As such, this

work is poised to make a broad impact on condensed matter physics and will open new directions in complex materials research.

Benefit to National Security Missions

Our work directly addresses the Grand Scientific Challenges identified in the Basic Energy Sciences Advisory Committee report, which are central to DOE's missions in energy, science, and security in general, and to the LANL Materials Pillar in particular. Our thrust to couple modeling, complex materials synthesis and ultrafast optical/X-Ray science aligns well with MaRIE vision of "material co-design" and further develops new capabilities for MaRIE science. During this project, we anticipate to access large BES X-Ray facilities at LCLS and APS in accord with institutional priority in supporting national user facilities. The proposed experiments are critical to achieving design and synthesis of new materials with controlled functionalities. Materials with tunable and novel functionality are an enabling component in the development of next-generation devices for sensing, information storage, and spintronics applications. We believe that our integrated capabilities in complex material design, synthesis and characterization will be of great interest to multiple sponsors, including DOE-BES, DOD, IC, and industry.

Progress

The goal of this project is to probe ultrafast spin dynamics in strongly correlated materials using time-resolved X-ray magnetic linear/circular absorption dichroism (XMLD/XMCD) spectroscopy. First-year goal was to develop a table-top time-resolved XMLD source and detector, and verify their performance on model complex materials. We have modified existing soft X-Ray source to enable generation of 30 femtosecond pulses with photon energies ranging from 20 to 100 electronVolts (eV) and high photon fluxes. This source was integrated into an XMLD spectrometer to enable the studies of photo-induced spin dynamics at sample temperatures between

4 and 400 K under ultrahigh vacuum conditions.

Following setup and optimization of the experimental geometry, we have used it to study the dynamic response of several antiferromagnetic materials. The XMLD technique probes p-d transitions of magnetic ions and is a valuable tool for understanding how spin order is coupled to other order parameters (charge, orbital, lattice), because d orbitals of transition metal ions are usually the origin of the magnetism in complex materials. In particular, our ultrafast tabletop soft x-ray source is capable of spanning the 3p-3d transitions (M-edges) of the transition metal components of many strongly correlated electron compounds. To study the dynamics of spin degrees of freedom, it is initiated by photo-exciting (pumping) a sample with a femtosecond near-infrared laser pulse which takes the material out of equilibrium and modulates spin ordering by transient modulation of charge density or exchange interaction, or by lattice distortions. Subsequently, a soft x-ray pulse probes the dynamics by monitoring absorption dichroism (polarization dependence) of the magnetic ion of interest.

In the first year, we focused our efforts on the first demonstration of feasibility of ultrafast broadband (20-100 eV) XMLD measurements using antiferromagnetic (AFM) SmMnO_3 (SMO) as a test system. Preliminary studies of the time-averaged (no pump) XMLD signal temperature dependence show an increase in XMLD signal below 60K which is consistent with the onset of AFM spin ordering at Neel temperature of 59K. Subsequently, we have measured the transient XMLD response of SMO in the AFM state to ultrafast optical excitation. We demonstrated that a very fast (~ 1 picosecond) drop in the XMLD signal occurs after excitation and happens only at Mn^{3+} absorption edge around 47 eV. This serves as a clear indication that the observed signal originates from an ultrafast change in ordering of Mn spins. To eliminate the possibility of experimental artifacts, we are currently performing similar measurements on Cr (AFM below $\sim 311\text{K}$) and $\text{La}_{0.42}\text{Ca}_{0.58}\text{MnO}_3$ (AFM below $\sim 250\text{K}$). When combined with theoretical simulations from our collaborators, these results will provide novel and, importantly, element specific, insight into photo-induced spin dynamics in AFM complex materials. These results will then be used as a basis for studies of more complex systems, such as multiferroics and high-temperature superconductors. As a groundwork and guidance for these future ultrafast time-resolved studies, we have performed static XMCD/XMLD experiments at SLAC SSRL synchrotron facilities. Here, we have made temperature dependent measurements of element-specific spin structure in multiferroic heterostructures. In particular, we have measured the effects of proximity on exchange bias mediated coupling between AFM BiFeO_3 (BFO) and ferromagnetic (FM)

$\text{La}_{1-x}\text{Sr}_x\text{MnO}_3$ (LSMO) thin films in layered and nanopillar heterostructures. In comparison with pure BFO films, the XMLD measurements at Fe edges in BFO/LSMO heterostructures show an appearance of new magnetic transition temperature ($\sim 130\text{K}$) in BFO, below which XMLD signal is suppressed thus indicating onset of proximity-induced FM order in AFM BFO material. To our knowledge this is the first time such effects in BFO/LSMO heterostructures have been observed using XMLD spectroscopy. This peculiar sensitivity of XMLD to proximity-induced FM ordering will enable future studies of FM spin alignment in complex materials heterostructures using our tabletop setup, because LANL ultrafast X-Ray source is currently limited to generation of linear X-Ray polarization.

Future Work

Exotic properties of complex materials emerge from the strong interactions among spin, charge, and lattice degrees of freedom (DOF). Existing theories cannot predict the emergent behavior, largely because available time-averaging experimental probes cannot decipher the interactions between particular DOFs. In this regard, ultrafast optical spectroscopy (UOS) offers an unmatched ability to separate various DOF and coupling among them in time domain. Our goal is to apply advanced UOS techniques to study time-dependent and element-specific processes that are important for understanding the DOF interplay in complex materials.

Based on our previous experience, we will apply our optimized table-top ultrafast X-Ray linear absorption dichroism probe to directly reveal the dynamics of spin and its coupling to charge and lattice in a set of novel multiferroic materials. In these materials, magnetic and ferroelectric polarizations are strongly coupled and allow manipulation of electric polarization with magnetic field and magnetization with electric field. Initially, we will study the dynamics and timescales of magnetization switching following the photoexcitation with ultrashort optical pulses. We will start with TbMn_2O_5 and BiFeO_3 multiferroic crystals and disturb the magnetic ordering by excitation with ultrashort optical pulses and ensuing modulations in strain, charge or orbital orders. Time delayed X-Ray pulses will monitor the changes of spin alignment on particular ions and quantify the time required for re-establishment of spin alignment in the material. Epitaxial heterostructures will be of particular interest due to anticipated enhancement of multiferroic properties caused by proximity effects. In particular, we will interrogate magnetic order dynamics in multiferroic $\text{BiFeO}_3/\text{La}_{0.7}\text{Ca}_{0.3}\text{MnO}_3$ and $\text{BaTiO}_3/\text{CoFe}_2\text{O}_4$ heterostructures. In these experiments, we will study the effects of strain and film composition on the spin re-ordering timescales. These experiments will shed a new light on the

coupling between charge/lattice and spin systems responsible for emergence of magnetoelectric coupling in multiferroics.

Conclusion

We expect that experimental and theoretical insights developed here will lead to a leap in our comprehension of the competing interactions in complex materials. Our novel ultrafast coherent photon probes will allow direct visualization of the real-time formation of competing orders, and will ultimately enable manipulation and coherent control of materials functionality. Our approach will fill the urgent need in integrated modeling, synthesis, and ultrafast nanoscale characterization capabilities essential to address several challenges in materials science. The understanding of complex materials properties developed here will have a significant impact on wide ranging technologies from information storage to energy applications.

Discovery of Novel Bioactive Natural Products

Alexander Koglin
20130815PRD4

Introduction

Nature is the source of medicinal products and toxins for millennia. Following the isolation of penicillins, natural product discovery focused on microbial sources and many have been widely used since then. Due to increasing drug resistance of all kinds of pathogens, understanding natural products' biosyntheses, speeding up their discovery and evaluation of potential medical use is an important goal. The advent of fast, low cost DNA sequencing led to a plethora of genomic data of bacteria and fungi. Now we are in a position to exploit those data in a multidisciplinary approach towards fast natural product discovery and isolation from microbial sources. Our pioneering work allows insight of how microbes produce bioactive compounds using biosynthetic multi-enzymatic clusters. We develop technology to identify the genes encoding for natural product biosynthetic machineries within translated genomic DNA. In addition, this technology allows us to anticipate which building blocks are incorporated by using bioinformatics and computational chemistry, and subsequently postulate the natural product's structure. Research steps are: 1. Genome Mining of selected bacteria will identify natural product biosynthetic machineries and predict building blocks (e.g. amino acids). 2. Bacterial strains are cultivated, natural products are extracted from cultures and identified by Nuclear Magnetic Resonance (NMR) and high-res mass spectrometry (MS). The availability of high-field NMR and excellent MS resources will uniquely enable the project at LANL. 3. Available techniques will be applied to elucidate structures of newly identified compounds. 4. Isolated genes of clusters will be transformed, expressed and biochemically characterized in vitro to validate the underlying biosynthesis. 5. The bioactivity of newly isolated natural products will be evaluated to gain insights into the natural product's antimicrobial, antiviral, cytostatic and cytotoxic properties as well as into its medical potency, which translates to measure of biosecurity and threat reduction by known and unknown biological toxins.

Benefit to National Security Missions

This project supports the LANL public health mission (Homeland Security Act 2002, DOE Strategic Plan 2011, Public Health Security and Bioterrorism Preparedness and Response Act 2002) as well as its mission in global threat reduction. It also has direct appeal to our WFO sponsors and the base knowledge acquired can be applied to increasing efficiency of novel product synthesis to make it more cost effective. It will both leverage and strengthen our capabilities in computing, genomic/meta genomic analysis and isotopic enrichment in a multidisciplinary project utilizing Mattias's skills to bridge the disciplines in support of missions in renewable energy, biosurveillance and biosecurity.

Progress

For the bioinformatic part of the project, it was proposed to identify at least 10 new gene clusters encoding for biosynthetic machineries for natural product production. Instead, I used a more sophisticated approach by systematically analyzing all available microbial genomes deposited in the NCBI database. The analysis was carried out using an adapted stand-alone version of the publicly available bioinformatic tool, AntiSMASH (Blin et al., Nucl. Acids Res. 2013, 41, W204). Within the analyzed 2,773 genomes of bacterial strains, more than 19,000 of these gene clusters were found. From this vast amount of available strains, five were chosen (*Myxococcus xanthus* DK 1622, *Coralloccoccus coralloides* DSM 2259, *Streptosporangium roseum* DSM 43021, *Catenulispora acidiphila* DSM 44928, *Herpetosiphon aurantiacus* DSM 785) in which the biosynthetic clusters are unusual, i.e. not following the classical linear, multi-modular organization (Strieker et al., Curr. Opin. Struct. Biol. 2010, 20, 234). This approach significantly reduces the probability of isolating compounds similar to known or identified natural products. Within these five strains a total of 124 gene clusters have been identified. Bioinformatic analysis revealed that 25 of these clusters showed unusual

organization and hence are likely to yield bioactive natural products. Subsequently, these clusters were analyzed in-depth using additional bioinformatic tools, such as pfam (Finn et al., Nucl. Acids Res. 2014, 42, D222), nrpspredictor2 (Röttig et al., Nucl. Acids Res. 2011, 39, W362) and 2metdb (Bachmann et al., Meth. Enzymol. 2009, 458, 181) to facilitate structure and building block prediction of the natural products.

The practical goals were to establish growth of five different bacterial strains and the isolation as well as structural characterization of three novel natural products produced by these strains, facilitated by feeding isotopically enriched, predicted building blocks. To meet these goals, the five abovementioned strains were successfully cultured under laboratory conditions. In addition to the bioinformatic prediction of the amino acid building blocks, it is important to biochemically correlate the identified gene clusters to the 25 predicted natural products by cloning and expression of the amino acid building block activation enzymes. This gives valuable insights into natural product assembly mechanisms and allows estimation of how the predictions match the actual substrate building blocks. In total 197 genes and gene fragments within the 25 clusters were annotated to be involved in building block (amino acid) activation. 75 of these genes have been successfully cloned and the generated expression plasmids were used to transform *E. coli* BL21 (DE3) cells to yield expression strains for the building block activating enzymes. In initial test expression studies using 23 of these heterologous strains protein production was observed. In the subsequent large scale expressions (10 of the 23 constructs tested so far), soluble protein was obtained in sufficient amount for biochemical characterization. By carrying out photometric assays (Wilson et al., Anal. Biochem. 2010, 404, 56) with the 20 natural amino acids for each individual building block activating enzyme, it was possible to confirm the activation of the predicted building blocks in 90% of the cases.

The feeding experiments for fast natural products isolation are currently limited to stable isotope labels (¹³C), as I am still waiting for the radiological permit for the faster ¹⁴C-feeding experiments. Practically, this means the compounds within the cell/supernatant extracts are separated by liquid chromatography (HPLC), the individual fractions are freeze-dried, the yielded solids are analyzed by NMR (Nuclear Magnetic Resonance) spectroscopy for ¹³C-carbon enrichment and hence the proposed natural product. For one bacterial strain this whole process can take up to four months for one novel natural product. So far, ¹³C-cysteine was fed to *Streptosporangium roseum* in order to facilitate isolation of a natural product that was predicted to be composed of three cyclized cysteines. From analysis

of individual fractions by the procedure stated above, isolation conditions for that predicted natural product were established, large scale isolation without label was carried out and the structure was elucidated by NMR. The isolated natural product showed three cyclized cysteines and an additional aromatic amino acid. Due to the delay in obtaining the radiological permit, only one of the targeted three natural products has been structurally characterized yet, but I am confident that the remaining two can be obtained by the end of FY14.

Future Work

During the second fiscal year the 25 identified biosynthetic clusters coding for new natural product machineries will be validated biochemically and used to proof the concept of genome mining for accelerated natural product discovery. Key steps during the second year are:

1. Continuing the isolation of the predicted natural products. The five in-house, established bacterial strains will be fed with isotopically enriched (e.g. ¹³C, ¹⁵N, ¹H or ³H, ¹⁴C) predicted building blocks of the proposed novel natural products; these can then easily be extracted from the culture by following the metabolic fate of the label. Incorporated isotopes readily identify proposed compounds after chromatographic separation.
2. Structure elucidation of isolated, novel natural products. Once separation from small-scale, enriched cultures is achieved, large-scale culturing without labels will follow. Available techniques - NMR, elemental analysis, high-resolution MS - will be applied to elucidate chemical structures of newly isolated compounds. The biosynthesis of natural products is highly transcriptionally controlled and isolation will likely not be achieved for all identified clusters. Nevertheless, five novel natural products should be structurally characterized in FY15.
3. Validation of the biosynthesis clusters for the isolated natural products. In order to link the isolated natural product to the biosynthetic gene cluster proposed, the building block activating enzymes of the 25 individual clusters will be cloned and expressed in *E. coli*, followed by activity assays. This will provide an estimate how well the prediction of the building blocks works and will guide improving the predictive algorithm as well as giving valuable insights into how nature produces bioactive natural products in general.
4. Initial bioactivity assays for the isolated natural products. The isolated natural products will be tested initially for antimicrobial activity against Gram-negative and Gram-positive bacteria using paper-disk and

MIC90 assays. In addition, siderophore activity will be tested using CAS assays.

Conclusion

It is clear that Nature, especially microbes, continue as a major source for drug leads. This project elegantly couples the advances in DNA sequencing with biochemical techniques, methods of structure elucidation and advanced knowledge in biosynthesis. The presented strategy will significantly shorten the time span for natural product discovery, lead to faster evaluation of bioactivity and consequently accelerate drug development. This supports the mission of LANL Bioscience in biosecurity and the lab's mission in threat reduction and global security. It guides future developments of accurate prediction of natural product structures exclusively based on genomic DNA information and vice versa.

From Food to Fuel: Making Ammonia Synthesis Viable for Energy Storage Applications

James M. Boncella
20130817PRD4

Introduction

The goal of this project will be the preparation of a new class of catalyst compounds that will be used to synthesize ammonia from nitrogen and hydrogen or water. This fundamental work will result in new methods for attaching these and similar catalyst materials to electrodes that will convert nitrogen and water from the atmosphere directly into ammonia using electricity. By attaching the catalyst materials directly to the electrode, we believe that an effective electrocatalyst for the synthesis of ammonia will become possible.

Currently there is no practical way to store electricity from a wind or solar power plant over hours to days time, which is necessary to level out the electricity production of these sources through the time when they cannot produce (e.g., if the wind does not blow or at night). The electrochemical synthesis of ammonia offers the potential to store electrical energy as ammonia because ammonia can be consumed in a fuel cell to produce electricity, thereby regenerating the electricity that initially formed it. Such storage would make it possible to capture a much larger quantity of electricity generated from renewable, intermittent sources such as wind and solar energy. The electricity (stored as ammonia) can then be regenerated when demand is higher or when the renewable source cannot generate power (e.g., if the wind does not blow or at night). In this way, this project takes a first small step toward this goal by investigating how it may be possible to store electricity directly as the chemical bonds in ammonia.

Benefit to National Security Missions

This work will provide basic information on how electrocatalytic compounds can bind to the surface of electrode materials. This will have an impact on the basic understanding of surface-metal complex interactions as well as on the ability of these molecules to participate in electrochemical reactions as catalysts. Because of

the use of this class of materials in the electrochemical synthesis of ammonia, the work will impact renewable energy production. If successful, it may offer an avenue to store energy from intermittent sources such as wind or solar power. Clearly any enabler of renewable energy will have a positive impact on energy security because it will decrease dependence on fossil fuels and it will have a positive impact on the climate because it does not produce carbon emissions. The DoD has a need for energy storage; this work may provide some insight towards field-deployable energy storage.

Progress

We have initiated work on synthesizing new molecular complexes for effecting the electrocatalytic reduction of dinitrogen to ammonia. To date, three molecular complexes have been reported in the literature to perform N₂-to-NH₃ catalysis, all of which use chemical reductants. Our strategy has been to synthesize a variant of one of these catalysts, modified with a tether capable of being attached to an electrode surface so that the transformation can be carried out electrochemically.

Specifically, the ligand in question is 2,6-(tBu₂PCH₂)₂-pyridine, and we have designed and begun to implement a synthetic protocol for generating a variant, which can be chemically attached to an electrode. The synthetic route is a six step process which has never been carried out with this specific compound. We have achieved the first four steps, each of which occurs in high (85-90%) yield. We found alternative methods for producing the halomethyl intermediate 2,6-(XCH₂)₂-4-Br-pyridine (X = Cl, Br) that does not require the use of volatile and reactive reagents. We are currently investigating the final two steps of the process, phosphine alkylation reactions to generate [2,6-(tBu₂PHCH₂)₂-4-Br-pyridine][X]₂ (the reaction works and purification of the product is currently underway), which will be used to generate the desired compound that will be attachable to the electrode surface.

Our plan moving forward is to introduce the transition metal, which would be performed in a similar manner as the original homogeneous chemistry, and the success of this strategy will be gauged by performing spectroscopic studies on the generated materials. We are purposely targeting optically transparent, conductive materials to facilitate characterization of our products. With the successful formation of our surface-adhered molecular transition metal complex, we will perform a range of studies to test the ability of these species to undergo electrocatalytic dinitrogen reduction, using a combination of spectroscopic techniques and known analytical chemistry methods for characterizing the products.

Future Work

This year we will complete the synthesis of the ligand that will bind the catalytically active molybdenum complex to the surface of an electrode. There is only one step left in the 6 step synthetic process, so we fully expect to complete this part of the project. Studies of the binding efficiency will be followed by studies of the electro-catalytic reduction of ammonia at the catalyst modified electrode. We will also pursue the possibility of reduction of nitrogen using chemical reducing agents such as hydrogen. This may be possible because of the changes in the reactivity of the molybdenum complex that are caused by tethering it to a solid surface.

Conclusion

The overall goals of this project are to synthesize catalysts for ammonia formation that can be directly attached to electrode surfaces. Such electrodes will facilitate the study of the electrochemical synthesis of ammonia which will result in a greater understanding of the process. Such understanding will support development of this process, which could enable the storage of electricity as fuel (ammonia) from wind turbines or solar arrays. The ammonia could then be used to regenerate electricity or as a fuel for transportation.

Complex Natural & Engineered Systems

Postdoctoral Research and Development
Continuing Project

Genetically Encoded Tools for Light-controlled Molecular Assembly

Geoffrey S. Waldo

20140660PRD1

Introduction

Familiar cellular process of gene expression, protein movement and sensing, all involve protein-protein interactions. Tools for monitoring these (such as fluorescent protein fusions like green fluorescent protein tags (GFP)) are relatively mature. But tools for controlling them lag far behind. Light/oxygen/voltage sensor proteins (LOV) have been used to control cell motility with light, for example, but required complex, bulky proteins to be attached to cell receptors. Furthermore, these fusions were “invisible” and required GFP to be attached to them to visualize their positions. On the other hand, we have made a split GFP of three pieces that can be used to monitor protein interactions (two proteins that interact bring together small fragments of GFP, then this is ‘detected’ by adding the remaining large piece of GFP). This system has the advantage that it becomes fluorescent when the interaction occurs, and that only small pieces or tags are attached to the test proteins. However, it is only a passive reporter. We plan to use laboratory evolution to tune the stability of the split GFP so that the cis-trans isomerization (change of the chromophore shape that accompanies absorption of light) and its associated steric strain makes the GFP fold and unfold with light. Since our GFP is a split, this folding and unfolding will translate to assembly and disassembly of the 3 pieces. The efficient light-switchable split GFP will be used to study and control the infection cycle of influenza and its interaction with host hemagglutinin proteins. We will also use this system to control the nucleation and formation of crystals of the influenza serine protease and the host target protein, leading to the first X-ray crystal structure of this complex. Since this protease action is required for infection, this should further our understanding and ability to control this disease.

Benefit to National Security Missions

Light switchable protein assembly/disassembly modules that are genetically encoded can be expressed in

living cells. This impacts health research, and our ability to monitor and manipulate host/pathogen biology. It also lets us control when and where transcription, cell-signaling and sensing, and cell-cell contacts occur in organisms and tissues. This tool lets us perform what-if experiments on host-pathogen interactions, and test hypothesis about the spatial and temporal roles of protein-protein interactions, for example the serine-protease activity on hemagglutinin required for influenza to enter host cells. This same technology can be extended to use versions of fluorescent proteins that recognize pathogen signature peptides, and trigger this recognition and binding using light. Energy and synthetic biology programs can benefit by using light to activate pathways to enhance production of commodity products by programming organisms to turn on the required biosynthesis when and where it makes sense. This fundamental tool allows light to be used for exquisite spatial and temporal control of disease, infection, and host-pathogen biology, important to the biosecurity component of our national security mission.

Progress

Natasha has focused on engineering versions of the Green Fluorescent Protein (GFP) that can be used to induce new modes of lattice formation in crystallization with partner proteins. The goal is to allow researchers greater diversity and chances to grow useful crystals of trial proteins in order to solve their structure. A key new outcome would be the use of light to induce the formation of these crystals on demand. This would allow the nucleation (nacent formation of microcrystals to be controlled by light. She hopes to use these libraries to (1) discover photoactivatable/dissociable split GFPs that also (2) induce new modes of lattice formation in crystallization trials. She has (1) engineered mutants of GFP 1-10 + S11 and GFP 1-9 + 10-11 that are depleted of natural cysteines in order to eliminate off-pathway dimer formation; tested dimer-inducing mutations in the split GFP

format in collaboration with Todd Yeates & David Leibly at UCLA. They had already made a set of split GFPs with new cysteines to create 'designed' contact points between the GFP molecules in the crystal. Natasha characterized these as GFP 1-9 + GFP 10-11 split proteins, and measured their stability and reassembly rates. Natasha has attached several proteins from mycobacterium tuberculosis to the GFP 10-11 fragment and complemented with the above GFP 1-9 mutants. Crystallization trials are currently underway. She is designing mutant libraries around the chromophore, which will be synthesized by GeneScript and screened at LANL to identify photodissociable/photoassociable split GFPs.

Future Work

The first year was focused on a two-body GFP, and the second year is focused on the a three-body GFP. The tasks seem similar on the surface, but the focus is on a completely different protein, yielding different results.

Task 1. Evaluate the ability of our existing split GFP (a green fluorescent protein broken into three pieces, "three-body") to come apart and reassemble after exposure to different colors of light. This will be facilitated by using two versions of the small pieces, one of which leads to green, the other a yellow version after assembly with the remaining large piece of GFP. Outcome: This way we can measure how much is converted (green/yellow ratio). We will have a table of light color, intensity, time, and fraction of the GFP that is disassembled/reassembled.

Task 2. Make libraries of mutants of this three-piece split GFP and express them in *E. coli*. We will look for color change signifying the displacement of the small strands, by the new color strands. This can only happen if the light activates disassembly and reassembly. Outcome: We hope to find mutants with enhanced ability to undergo this assembly and disassembly.

Task 3. The best performing mutants of Task 2 (best light switchable split GFPs) will be tested using the same protocol as Task 1. We will use these to bring together hemagglutinin substrate and the serine proteases of influenza, and measure the enhanced cleavage. We will extend this work using the *E. coli* membrane-associated RND pump. We will also test model protease/substrates including tobacco-etch virus protease and a substrate. Outcome: We expect light-activated assembly of the protease and substrate to enhance this cutting rate and efficiency. The effect of locking together the components of the RND pump will be determined by using resistance to tetracycline.

Conclusion

Development of an efficient light-controlled modular protein that can be assembled and disassembled with light. This tool could revolutionize experimental biology by leveraging all the existing work on full-length and split fluorescent proteins as reporters of protein interactions, giving the key added function of controllers of protein interactions. Transcription, signaling cascades (passing biochemical signals between interacting proteins), caging and releasing substrates with light (to turn on signals at a whim) will all benefit by the exquisite temporal and spatial control afforded by light. Optical imaging (superresolution microscopy) can be extended to spy on protein-protein interactions beyond conventional optical resolution.

Tracking Microbial Activity to Predict the Impacts of Climate Change on Ecosystem Function

Cheryl R. Kuske
20140662PRD1

Introduction

Ecosystem processes such as nutrient cycling sustain life on earth, and are controlled in large part by communities of fungi and bacteria (collectively termed microbes) that reside in the soil. Global changes, such as nitrogen deposition, warming, elevated CO₂, and altered precipitation, alter the abundance and biodiversity of microbial communities and significantly alter ecosystem functions. Soil microbial communities largely determine whether terrestrial ecosystems act as carbon sources or sinks under elevated CO₂. However, biochemical processes mediated by complex microbial interactions in the soil remain a black box in terrestrial ecosystem models. A major hurdle in linking complex soil communities to major ecosystem processes is the ability to distinguish among the active and dormant members of the community. Understanding how dormancy structures microbial communities is of particular concern because it is a strategy for survival under unfavorable environmental conditions, and could be a pathway for resiliency of microbial communities to climate changes. I will use a combination of high-throughput DNA and RNA sequencing with targeted measures of activity in field-scale experiments and contrived community experiments in the laboratory to determine the relative contributions of the active populations, as well as the constraints on the ability of microbial populations to enter and exit from dormancy. Collectively, these studies will help us understand how the microbial community regulates climate change responses and feedbacks in the soil.

Benefit to National Security Missions

First, this project will help fill a significant information gap in our knowledge of and ability to predict the outcomes of processes that are mediated by complex microbial communities in soils. Soils are an enormous reservoir of carbon (C) on Earth, and the concerted activities of soil microbes regulate the storage or release of this C. Second, the project directly contributes to

DOE missions in biological systems science and climate change responses. It also advances metagenomics technologies and basic environmental surveys that enable more accurate, specific detection of target microorganisms in environmental samples, thus contributing to a technology base supporting biothreat detection. Third, this project advances our understanding of fungal and bacterial biomass and metabolic capabilities; these are organisms from which we have historically derived most of our antibiotics, as well as other pharmaceuticals and industrial enzymes. Fourth, many of the fungi we will be studying also have potential in processing C for biofuels applications.

Progress

A soil microcosm experiment that compares microbial community responses to increased moisture, increased nitrogen, and warming temperatures is nearly complete. Measures of soil respiration have been collected over the time-course experiment. Extraction of soil RNA and DNA are currently underway.

In addition to manipulating soils with the above additions, we used three different stresses in order to determine which community members are able to survive harsh environmental conditions, including heating to 65C, freezing at -80C and long-term dessication. Measurements of soil respiration and community composition are planned for the next two months. In addition, we are in the process of constructing contrived communities of known composition to link known functional genes to ribosomal genes to gain a greater understanding of using rRNA as an indicator of activity.

We have a predicted timeline for sequencing and community analysis for the first phase of this experiment of two months. Completion dates for subsequent experiments are projected for 6 months.

Expected publications. We expect to generate two publications from the initial experiment, one linking soil respiration with community composition of fungal and bacterial communities, and another examining the dynamic rank abundance curves of active and dormant fungal and bacterial communities, which will include data from the stress experiments currently underway. Results from analysis of the contrived communities will result in an additional publication.

Future Work

Objective: To investigate how dormancy determines community response to global change and the implications of dormancy on soil processes.

Rationale: The major goal of the SFA is to understand how global change, primarily nitrogen deposition, will affect microbial communities, and in turn, important ecosystem functions, such as carbon cycling. Understanding how dormancy structures microbial communities is important for understanding both the long- and short-term impacts of global change on microbial biodiversity because it is a strategy for survival under unfavorable environmental conditions, and is a potential pathway for resiliency of microbial communities to global change.

Approach: We are using controlled laboratory approaches to study the response of natural microbial communities, in two contrasting soils, to multiple environmental manipulations (e.g., increased water availability, increased temperature and increased nitrogen availability). The responses to these perturbations are tracked over time by quantifying soil respiration using gas chromatography. The active and total communities will be measured using molecular analysis of rRNA and rDNA in order to both link the composition of the active community to measures of soil respiration, as well as to quantify shifts in the active community over time. These measures will allow us to determine the short-term community responses to predicted global changes, and to link those shifts with ecosystem function.

Conclusion

The goals of this project are to understand the relative contributions of active soil bacterial and fungal populations, and constraints on their ability to enter and exit from dormancy, to enable accurate predictions of C or N fluxes from the soil. By quantifying microbial activity and dormancy under dynamic environmental conditions, my proposed studies will determine how the microbial community regulates climate change responses and feedbacks in the soil, which are critical for development of soil process models and to define appropriate input variables in

regional climate models.

Publications

Mueller, R. C., M. M. Balasch, and C. R. Kuske. Contrasting soil fungal community responses to experimental nitrogen addition using the large subunit rRNA taxonomic marker and cellobiohydrolase I functional marker. 2014. *MOLECULAR ECOLOGY*. 23 (17): 4406.

Complexes Containing Redox-active Ligands for the Synthesis of Fuels from Readily-Available Carbon Sources

John C. Gordon
20140664PRD2

Introduction

The proposed work will investigate the development of catalytic systems that convert readily available, highly oxidized precursors such as carbon dioxide, acetic acid, and glycerol into higher-order compounds containing more carbon atoms that can readily be converted into alkanes, which are the main components of transportation fuels. This work addresses both the synthesis of the higher order fuel precursors and their defunctionalization to produce hydrocarbons that would be suitable as fuels. This has the potential to convert biorenewable and abundant molecules into molecules with potential use as fuels.

Benefit to National Security Missions

The goal of the project is the synthesis of molecules that can serve as fuels from readily available and sustainable molecules such as CO₂, acetic acid, and glycerol. These goals are directly in line with DOE OBES's interests in fundamental chemistry and catalysis science and DOE EERE's interests in sustainable and biorenewable chemistry. This work also directly impacts the area of climate and energy impact vis-a-vis the conversion of biorenewable and abundant small molecules into higher order carbon containing species with potential use as hydrocarbon fuels for transportation applications.

Progress

The concomitant rise in global energy demands and growing concerns over climate change have spurred interest in the development of less-expensive synthetic methods for high-value chemical feedstocks. To address this challenge, we are developing a system that converts readily available, highly oxidized C_n ($n \leq 3$) precursors such as CO₂, acetic acid, and glycerol into higher-order C_m ($m \geq 6$) compounds that can readily be converted (via hydrogenation/dehydration reactions) into alkanes, which are the main components of transportation fuels. This technology will be comprised of two separate

chemical concepts: the reductive coupling (via C-C bond formation) of the carbon precursor(s) and defunctionalization (oxygen atom removal) of the coupled product. Not only are there relatively few reports detailing homo- or hetero-coupling of C_n precursors, but the defunctionalization of highly oxidized C_m compounds is still an emerging field.

Our approach to the challenges outlined above involves the use of earth-abundant, first-row transition metals supported by ligands that possess redox reactivity. While first-row transition metals typically undergo one-electron redox changes, the coordination of redox active ligands to first-row transition metals permits the storage of extra electrons on the metal complex without the need to access energetically unfavorable metal oxidation states. The lower energy input is expected to directly translate to more efficient catalysts for the reductive coupling of carbonyl compounds and the reduction of highly oxygenated substrates.

To this end, a series of six redox active ligands and the corresponding divalent first-row transition metal complexes (V, Cr, Mn, Fe, Co, Ni, Cu, Zn) have already been synthesized. The spectral, structural, and electrochemical characterizations of these compounds are now currently underway. Spectral and structural data not only will reveal the identity of these compounds but also will validate electronic structure calculations. The electrochemical studies will not only guide subsequent synthetic efforts towards the one-, two-, and three-electron reduction congeners but will identify stoichiometric reaction conditions that facilitate carbon-carbon bond coupling and reduction of highly oxygenated substrates. Finally, once promising transformations are found, catalytic reactions will be developed and the responsible mechanisms evaluated with regard to both kinetics and thermodynamics.

Future Work

We will continue to develop synthetic routes towards new redox active metal complexes. As alluded to in the progress section, we have already prepared a series of divalent first-row transition metal complexes. Physical characterization of these molecules is presently underway. The spectral and structural characteristics of these molecules will be used in conjunction with electronic structure calculations to evaluate their potential in promoting chemistries of interest.

The use of electrochemistry will not only guide subsequent synthetic efforts towards one-, two-, and three-electron reduction congeners, but will also be useful in identifying stoichiometric reaction conditions that facilitate carbon-carbon bond coupling and the reduction of highly oxygenated substrates. Finally, once promising transformations are found, catalytic reactions will be developed and the responsible mechanisms evaluated with regard to both kinetic and thermodynamic considerations.

Conclusion

The goal of the project is the synthesis of molecules suitable as fuels from readily available and sustainable molecules such as carbon dioxide (CO₂), acetic acid, and glycerol. This has the potential to convert biorenewable and abundant molecules into molecules with potential use as hydrocarbon fuels.

Bottom-up Chemical Synthesis of Large, Well-Defined, and Organo-Processable Nanographene-based Triarylamine for Optoelectronic Applications

Hsing-Lin Wang
20140666PRD2

Introduction

The main focus of this project is to develop synthetic strategies for making triarylamine-based nano-graphene (TAA-NG), a small piece of graphene with well-defined molecular structure. NG with flexible alkyl chains attached to the periphery of NG renders solubility in organic solvents and allows self-assembly of NGs with phase separation into nanoscaled morphology in composite materials. More importantly, the incorporation of heteroatoms such as triarylamine (TAA) into the graphene frameworks leads to a triangular shape and charge transfer characteristics, which, to the best of our knowledge, have never been attempted. The challenge of this project lies in the fact that the organic synthetic scheme for TAA-NG requires more than 20 steps. This is a costly and time-consuming process. Although synthesis of simple NGs have been demonstrated, synthesis of TAA-NG remains a challenge and the final yield of this compound may be low, which could impede us from developing applications using this materials. Therefore, our challenges are not only in the synthesis of TAA-NG, but also in finding ways to increase the yield of the final product.

We expect the as-prepared TAA-NG will reveal fine-tuned optoelectronic properties tailored for the applications in electrochromic, memory device, LED, photovoltaic cell, fuel cell, lithium battery, and super-capacitor. Success in demonstrating derivatized NGs in the above devices could have intellectual property value and warrants publications in high impact journals.

Benefit to National Security Missions

This project aims at developing nanographenes with tunable electronic structures and optical properties. The integration of functional NGs into clean energy technologies could bridge the gap between basic research and commercialization of graphene based energy devices. Further developing NG-based materials will strengthen

our leadership role in NG research, which has strong ties to laboratory mission in the areas of exotic materials and energy security.

Progress

We propose a bottom-up organic synthesis approach to create organosoluble, functional graphenes with well-defined molecular structure, spanning sizes from benzene molecule to nanographenes. The novel nanographenes have been synthesized by FeCl₃-assisted oxidation cyclization of the hexaphenylbenzene-based triarylamine derived from triphenylamine by subsequent stepwise iodination, Sonogashira coupling, and Diels-Alder cycloaddition. Branched alkyl side chains are attached to render solubility in organic solvents for further chemical reactions. The synthesized triarylamine is called nanographene consisting of three flakes, each flake consists of 13 fused benzene rings with a dihedral angle of around 109.5 degrees between them. The covalently triarylamine-attached nanographenes have been confirmed by X-ray, SEM, TEM, NMR, MALDI-TOF MS, and IR spectroscopy.

These nanographenes with strong donor-acceptor nature have revealed great promises for organic electronics and their optical and electronic properties. Of particular interest is the optical properties as they exhibit blue and yellow emission before and after fusion of benzene rings, respectively. These results validate an extended conjugation upon fusion of benzene rings through oxidation reaction using FeCl₃. These nanographenes also self-assembled into higher ordered crystalline structure with controlled d-spacing from 3.5 to 4.36 Angstrom. Such precise control of d-spacing in nanographenes has never been demonstrated.

These as-synthesized nanographenes have been incorporated into the anode in lithium ion batteries, exhibiting superior charge capacity and charging-recharging

cycle stability. The decay of charge capacitance is less than 30% and the battery performance remains stable for more than three months. In contrast to our nanographenes, the graphene oxide (GO) and RGO have a capacitance decay for more than 70 percent in 30 cycles. Therefore, nanographenes have emerged as one of the most exciting battery anode materials. We will continue to explore various nanographene structures and try to establish structure-property relationships between nanographene structure and Li ion battery performance.

Future Work

In the next fiscal year, we will focus on the synthesis of heteroatom (N, or B) doped nano-graphenes through a newly designed synthetic route. Such synthesis includes Curtis rearrangement, Sonogashira coupling, Suzuki coupling, Diels-Alder cycloaddition, and Ullmann reactions. The molecular structures and crystallinity of these nitrogen/boron doped nanographenes will be characterized by X-ray diffraction, scanning electron microscopy, scanning tunneling microscopy, atomic force microscopy, MALDI-TOF Mass spectroscopy, infrared spectroscopy and nuclear magnetic resonance spectroscopy. Electronic and optical properties of these nitrogen doped nanographene will be determined by UV-Vis spectrometer and fluorescence spectrometer. We will measure the redox potentials of these nanographenes by cyclic voltametry, coupled with the absorbance spectra to construct the band diagram of nanographenes. The incorporation of nitrogen/boron in the nanographene is expected to increase the incorporation of metal atoms and rate of diffusion. Therefore, we will incorporate these nitrogen-doped nanographenes as part of anode material in lithium ion battery (LIB) and evaluate the performance characteristics in terms of capacity, stability through hundreds of charging-recharging cycles. We will also evaluate the use of these novel nanographenes as new electrochromic material, and demonstrate the use of these materials for memory devices.

Conclusion

We expect to achieve synthesis of processable nano-graphene. Our proposed synthesis promises ways to control NGs with size-dependent band gap, optical absorptivity, and charge transfer functionality. Success of this project is likely to generate a new class of materials with emergent functionality previously not accessible through fabrication methods. The integration of functional NGs into clean energy technologies could bridge the gap between basic research and commercialization of graphene based energy devices. Further developing NG-based materials will strengthen our leadership role in NG research, which has strong ties to laboratory mission in the areas of exotic ma-

terials and energy security.

Publications

- Kuo, , Nie, Tsai, Yen, A. D. Mohite, Gupta, A. M. Dattelbaum, D. J. William, K. C. Cha, Yang, Wang, and Wang. Structural Design of Benzo[1,2-b:4,5-b']dithiophene-Based 2D Conjugated Polymers with Bithienyl and Terthienyl Substituents toward Photovoltaic Applications. 2014. *MACROMOLECULES*. 47 (3): 1008.
- Park, Y. I., O. Postupna, A. Zhugayevych, S. W. Kyu, , Y. S. Park, B. Kim, H. J. Yen, P. Cheruku, J. S. Martinez, J. Park, S. Tretiak, and H. L. Wang. A new pH sensitive fluorescent and white emissive material through controlled inter-molecular charge transfer. 2014. *CHEMICAL SCIENCE*. : DOI: 10.1039/C4SC01911C .
- Yen, , Tsai, Kuo, Nie, A. D. Mohite, Gupta, Wang, Wu, Liou, and Wang. Flexible memory devices with tunable electrical bistability via controlled energetics in donor-donor and donor-acceptor conjugated polymers. 2014. *JOURNAL OF MATERIALS CHEMISTRY C*. 2 (22): 4374.

Mesoscopic Lattice Boltzmann Modeling and Investigation of Boiling Multiphase Flows

Qinjun Kang
20140669PRD2

Introduction

Boiling multiphase flows are ubiquitous in nature as well as in many industrial applications. Nucleate boiling, a well-known boiling phenomenon, has been recognized as one of the most effective heat transfer modes and used in a wide field of high-tech devices and systems such as nuclear reactors, heavy-vehicle engines, computer chips, and micro-electronic devices. However, despite years of tremendous research effort, many aspects of boiling are still not well understood, e.g., the physical mechanism causing the critical heat flux is not revealed. Novel methods are highly demanded for a better understanding of boiling multiphase flows. In the past years, the mesoscopic lattice Boltzmann (LB) method has been developed into an alternative approach for simulating multiphase flows, in which the interfaces can arise, deform, and migrate naturally as a result of particle interactions, without needing a cluster of marker points to track the interfaces or capturing the interfaces via the evolution of an order parameter. In this project, we will develop a novel, physics-based thermal LB model for modeling boiling multiphase flows to obtain new insights into the mechanisms of boiling heat transfer. We plan to approach the target in three stages by: (I) developing a novel thermal LB model for multiphase fluids with phase change, capable of treating large density ratios and a wide range of temperature variations, which is not achievable with existing models; (II) investigating boiling multiphase flows at the macroscale level, focusing on the topics of bubble formation with different wall properties, changes of flow patterns, the mechanism of the critical heat flux, as well as boiling flow in a rod-bundle geometry, which is the situation of important interest in nuclear reactors; (III) investigating the mechanism of boiling heat transfer in microchannels, focusing on key issues of the effect of surface tension, contact angle, and micro-structured surfaces.

Benefit to National Security Missions

The successful accomplishment of the proposed research will provide (1) an improved understanding of boiling phenomena, e.g., new insights into the physics of critical heat flux at different scales through mesoscopic modeling based on statistical-analysis and (2) an innovative technique, which can be coupled with molecular dynamics simulations and continuum models, leading to multi-scale modeling of thermal multiphase flows. The proposed work supports physics-based prediction models of departure from nucleate boiling, one of the grand challenge problems of the DOE Consortium for Advanced Simulation of Light Water Reactors (CASL). The approach will also have significant implications in other research areas including spray cooling, nucleate boiling heat transfer of nanofluids, and cooling of micro-electronic devices. It will support LANL Grand Challenge to develop transformative new energy technologies and to significantly enhance and extend the use of current technologies in a manner that is sustainable and that mitigates negative environmental, social, and national security impacts. It will also support DOE's goals in promoting energy security.

Progress

At the time of this report, the Director's Postdoctoral Fellow, Dr. Qing Li is expected to join the Laboratory in July, 2014.

Future Work

The overarching goal of this project is to develop a novel, physics-based thermal lattice Boltzmann (LB) model for modeling boiling multiphase flows to obtain new insights into the mechanisms of boiling heat transfer. We plan to approach the target in three stages by: (I) developing a novel thermal LB model for multiphase fluids with phase change, capable of treating large density ratios and a wide range of temperature variations, which is not achievable with existing models; (II) investigating boiling

multiphase flows at the macroscale level, focusing on the topics of bubble formation with different wall properties, changes of flow patterns, the mechanism of the critical heat flux, as well as boiling flow in a rod-bundle geometry, which is the situation of important interest in nuclear reactors; (III) investigating the mechanism of boiling heat transfer in microchannels, focusing on key issues of the effect of surface tension, contact angle, and micro-structured surfaces. In the next fiscal year, we will focus on stage 1. We will build upon our extensive expertise in the theory and applications of the interparticle potential multiphase LB model, as well as our experience with large-scale parallel computing. Specifically, we will implement physics-based equation of state into the multiphase LB model to enable the simulation of multiphase flow with large density ratio between the liquid and gas phase, representative of nucleate boiling phenomenon. We plan to publish 2-3 journal articles in the novel model and its numerical implementation on a computer.

Conclusion

The primary goal of this research is to develop a novel thermal lattice Boltzmann model for modeling boiling multiphase flows to obtain new insights into the mechanisms of boiling heat transfer. The successful accomplishment of the project will provide an improved understanding of boiling phenomena and an innovative mesoscopic technique. This project supports physics-based prediction of departure from nucleate boiling, one grand challenge problem of the DOE Consortium for Advanced Simulation of Light Water Reactors. The approach will also have significant implications in other research areas including spray cooling, nucleate boiling heat transfer of nanofluids, and cooling of micro-electronic devices.

Publications

Li, Q., K. Luo, Q. Kang, and Q. Chen. Contact angles in the pseudopotential lattice Boltzmann modeling of wetting. To appear in Physical Review E.

Access to Industrially Important Optically Active beta-X-alcohols via Direct Enantioselective Ester Hydrogenation

John C. Gordon
20140672PRD2

Introduction

Contrary to ketones, limited progress in the hydrogenation of less-electrophilic esters has been made during the last few decades. Industrial homogeneous reduction of esters still relies mostly on the use of metal hydride reagents such as LiAlH_4 or NaBH_4 . Using these reagents, hydrogenation selectivities cannot be controlled and such spent (waste) reductants require energetically intensive regeneration input or disposal. Also the use of heterogeneous catalysis dictates the use of high temperatures and pressures and again selectivities cannot be controlled.

No reports describe detailed enantioselective ester hydrogenation despite the tremendous potential for synthetic organic chemistry. Current "state-of-the-art" catalysis in this area of chemistry has required complicated multi-step ligand synthesis as well and these ligands once synthesized often exhibit air-sensitivity. This work will thus focus on developing new well-defined chiral bifunctional molecular catalysts incorporating air-stable ligands for the enantioselective hydrogenations of esters via dynamic kinetic resolution.

Benefit to National Security Missions

Success in this chemistry could have significant positive impact for LANL, vis-à-vis the application of new approaches to polymers and materials synthesis, in energy applications, and in health related (e.g. pharmaceutical) R&D. This work if successful will potentially lead to high profile publications (*Angew. Chemie.*, *JACS*, etc.) for the Laboratory and will place LANL at the forefront of this developing area of chemistry.

Progress

In contrast to ketones, limited progress has been achieved with respect to the hydrogenation of carboxylic (anhydride, imide, ester, carboxylic acid, carboxamide) and carbonic (carbonate, carbamate, urea) acid deriva-

tives, despite the tremendous potential for synthetic organic chemistry and industrial applications. Reduction of these less electrophilic carbonyl compounds (for example to manufacture alcohols or amines) still relies mostly on heterogeneous hydrogenation catalysts operating under very harsh reaction conditions (for esters, for example 140–210 atm hydrogen pressure, 200–300 °C) or the stoichiometric use of metal hydride reagents, such as LiAlH_4 , NaBH_4 , and their derivatives. The latter have poor compatibility with functional groups, and are atom uneconomical due to waste generation. During the past decade, significant and rapid progress in (particularly) ester molecular hydrogenation has been achieved by utilization of conceptually new bifunctional molecular catalysts originating from the metal–ligand cooperation effects.

The aim of our work is to develop novel ligands and their corresponding transition metal complexes that will be used as novel catalysts for the catalytic hydrogenation of carboxylic and carbonic acid derivatives. In this regard, we have prepared a series of novel and new multidentate achiral ligands as well as chiral ligands from readily available, cheap commercial precursors. In contrast to traditional phosphorus containing ligands that are widely used in the area of catalytic homogeneous hydrogenation and have been significantly commercialized for the last two decades, many of our ligands are air-stable. We believe that our novel ligand scaffolds will open up new possibilities in bifunctional molecular catalysis. Using a number of these ligands, we have also prepared and structurally characterized a series of well-defined metal complexes and have begun to explore the hydrogenation characteristics of these molecules.

Recently we filed a provisional patent related to this work ("Ligands and Complexes for Catalytic Hydrogenation of Carboxylic and Carbonic Acid Derivatives", US Provisional Patent Application No. 62/009,483, filed June 9th, 2014).

Future Work

We will incorporate newly developed and synthesized air-stable chiral ligands onto metals such as Cu in order to perform catalytic asymmetric ketone hydrogenation. These new well-defined robust Cu complexes can potentially be used in other important asymmetric transformations as well, (e.g hydrosilylations, hydroborations, transfer hydrogenations, allylic substitutions, Michael additions, Henry reactions, etc.), so if time permits we will examine some of these reaction as well.

Conclusion

In addition to the environmentally benign processes outlined above, our goals will go further: currently, the ruthenium (Ru) catalyzed asymmetric hydrogenation of ketones (R. Noyori, Nobel Prize 2001) is the main route to produce optically active secondary alcohols. The utilization of expensive Ru catalysts however is unattractive in terms of cost. It is envisioned that if the enantioselective hydrogenation of ketones could be catalyzed by less-expensive base metal complexes. We will incorporate newly developed and synthesized air-stable chiral ligands onto cheap metals such as copper in order to perform catalytic asymmetric ketone hydrogenation.

Synthesis and X-ray Spectroscopy of Actinide Thiocyanates

Stosh A. Kozimor
20140677PRD3

Introduction

As the need to develop a closed nuclear fuel cycle grows, there are a number of technological challenges that need to be overcome. One of the most difficult challenges is the separation of the minor actinides (Am^{3+} and Cm^{3+}) from the trivalent lanthanide fission products as they share many physical properties. A number of studies have shown that this separation is possible by employing soft ligands (such as those containing S or N donors), which preferentially bind the actinides (An) over the lanthanides (Ln). One particularly promising extractant is the SCN^{1-} anion that provides enhanced separation of An over Ln. Although little is understood about why the SCN^{1-} extractant is successful, it seems likely to be associated with the propensity of NCS^{1-} to form more covalent An–NCS vs Ln–NCS bonds. We propose to characterize the M–NCS interactions by synthesizing $\text{An}(\text{NCS})_{xy}$ (An = Pu, Am, Cm) complexes and subsequently analyzing the $\text{An}(\text{NCS})_{xy}$ compounds using ligand K-edge X-ray absorption spectroscopy (XAS) and DFT calculations.

Benefit to National Security Missions

This investigation will develop a fundamental understanding of bonding for plutonium and the other actinide elements. The results will be applied to DOE's efforts to design practical and efficient separations of the lanthanides and minor actinides. Moreover, the research will provide discrete probes for quantifying covalency that will be used in future efforts to analyze strategically important actinide materials and aid the DOE in its mission to support the national nuclear agenda that includes expanding nuclear power for energy security, preventing the spread of nuclear weapons, securing nuclear materials against theft, reducing the size of nuclear arsenals, and cleaning up the legacy of the Cold War.

Progress

At the time of this report, the postdoc was recently hired at the Laboratory.

Future Work

Work in FY15 will focus on developing a synthetic route to trivalent f-block SCN^{1-} complexes, and (b) establishing the bonding character of these complexes through multiple spectroscopic and theoretical techniques, primarily S, N, and C K-edge XAS and TDDFT.

Conclusion

Completion of this work will mark the first synthesis of trivalent $\text{An}^{3+}(\text{NCS})_{xy}$ compounds and the first transplutonium S, N, and C K-edge XAS experiments. Developing an understanding of the bonding in these complexes will shed light on both the differences in Ln/An–NCS interactions and highlight how An–NCS bonding varies as the 5f series is traversed from Pu to Cm.



Information Science & Technology

Disruptive Innovation in Numerical Hydrodynamics

Jacob I. Waltz
20130005DR

Introduction

This project researches and develops innovative approaches for the numerical modeling of high-speed material flows that leverage emerging computer architectures and are applicable to a wide range of scientific and national security problems. The technologies under consideration are designed to enhance fidelity and computational efficiency relative to existing methods, especially in the areas of vorticity, time accuracy, and thermodynamic consistency. The specific focus is high-fidelity three-dimensional algorithms that have not been previously applied to LANL and NNSA problems but have significant potential should they be successfully developed.

In addition to the above this project is investigating approaches for emerging computer architectures such as the Graphics Processing Unit (GPU). Effective use of this computer hardware requires a large shift in both the design of numerical algorithms and the use of simulation tools. The research performed under this project is intended to address both issues and thereby create a path forward for emerging architectures and Exascale concepts, for example by emphasizing accuracy over memory.

The development of transformative numerical algorithms that are simultaneously optimized for new computer architectures carries significant technical risk, but if successful will enable a dramatic leap forward in predictive simulation capability.

Benefit to National Security Missions

We expect our research to lead to orders of magnitude improvements in fidelity and computational efficiency for work related to NNSA Defense Programs, Non-proliferation, and Science Campaigns. The impacts of these improvements will include faster responses to programmatic questions; increased population sizes for

Uncertainty Quantification and other sensitivity studies; greater detail in discovery-scale simulations; and an enhanced ability to model realistic 3D features. Our work will also enable the use of commodity mesh generation software, which could lead to cost savings of several million dollars per year, and reduce problem setup time. Lastly, our work will allow future compute platforms to be used earlier and more effectively.

Future Mission: The jump in simulation capability that results from our research will enable the solution of entirely new classes of problems and therefore has the potential to significantly expand the scope of the Laboratory's simulation tools. New application areas might include design of blast mitigation structures for urban environments, energetic disablement calculations of Improvised Explosive Devices, anti-personnel and anti-structural analysis, and high-resolution studies of mix and ignition in Inertial Confinement Fusion targets.

Progress

During the past 12 months the project made important breakthroughs related to Lagrangian and arbitrary Lagrangian-Eulerian hydrodynamic algorithms. Specifically, a fundamental error in traditional Lagrangian hydrodynamic algorithms was discovered. After in-depth theoretical analysis, new algorithms which are free of this error were developed, implemented, and tested. Two peer-reviewed journal articles describing the new algorithms were submitted; one is in press and the second is under review.

Journal articles on arbitrary Lagrangian-Eulerian hydrodynamics, efficient use of computer hardware, and innovative test problems also were published or submitted during the past 12 months. A total of four conference presentations were given along with one invited presentation at a high-level internal review.

The project made significant progress towards its major FY14 goal involving domain-decomposed parallelism. This work is expected to be completed around the end of the FY, and associated documentation will be produced in FY15. The project also completed preliminary work in support of its major FY15 goal involving multi-material simulation capabilities.

Future Work

The major 2015 milestone for this project is to demonstrate multi-material simulations with strength, including convergence analysis, comparison to experiment, and timing studies.

This work will be documented with journal papers, internal reports, and/or presentations at technical conferences.

Conclusion

The goal of this project is to develop innovative approaches for the numerical modeling of high-speed material flows that leverage emerging computer architectures and will form the basis of next-generation simulation tools. The impacts of this work will include significant enhancements in simulation detail and accuracy; reduced uncertainty in simulation-based responses to programmatic issues; advances in scientific understanding in the broader numerical modeling community; and increased diversity in the suite of methods that are trusted for LANL and NNSA problems.

Publications

Canfield, T. R., M. R. J. Charest, N. R. Morgan, L. D. Risinger, J. Waltz, and J. G. Wohlbier. Simulation of multi-material flows using a finite element Riemann solver and adaptive unstructured grids. Presented at Conference on Numerical Methods for Multi-Material Flows. (San Francisco, CA, 2-6 Sep. 2013).

Canfield, T. R., N. R. Morgan, L. D. Risinger, J. Waltz, and J. G. Wohlbier. Manufactured solutions for the three-dimensional Euler equations with relevance to inertial confinement fusion. Presented at American Society of Mechanical Engineers Verification and Validation Symposium. (Las Vegas, NV, 22-24 May 2013).

Long, A. R., T. R. Canfield, M. R. J. Charest, N. R. Morgan, J. Waltz, and J. G. Wohlbier. Implicit Monte Carlo discretizations for tetrahedral meshes with node-based unknowns. Presented at Nuclear Explosives Code Developers Conference. (Los Alamos, NM, 20-24 Oct. 2014).

Morgan, N. R., J. Waltz, D. E. Burton, M. R. J. Charest, T. R. Canfield, and J. G. Wohlbier. A Godunov-like point-centered essentially Lagrangian hydrodynamic approach. To appear in *Journal of Computational Physics*.

Morgan, N. R., J. Waltz, D. E. Burton, M. R. J. Charest, T. R. Canfield, and J. G. Wohlbier. A point-centered arbitrary Lagrangian Eulerian hydrodynamic approach for tetrahedral meshes. *Journal of Computational Physics*.

Morgan, N. R., J. Waltz, D. E. Burton, T. R. Canfield, L. D. Risinger, J. G. Wohlbier, and M. R. J. Charest. A Godunov-like point-centered ALE finite element hydrodynamic approach. Presented at Conference on Numerical Methods for Multi-Material Fluid Flow. (San Francisco, CA, 2-6 Sep. 2013).

Morgan, N. R., J. Waltz, D. E. Burton, T. R. Canfield, M. R. J. Charest, and J. G. Wohlbier. Application of a multi-dimensional approximate Riemann solution to point centered hydrodynamics on tetrahedral meshes. Presented at Nuclear Explosives Code Developers Conference. (Los Alamos, NM, 20-24 Oct. 2014).

Waltz, J.. GPU and multicore acceleration of a 3D unstructured mesh Eulerian-AMR hydrocode. Presented at Nuclear Explosives Code Developers Conference. (Livermore, CA, 22-26 Oct. 2012).

Waltz, J., J. G. Wohlbier, L. D. Risinger, T. R. Canfield, M. R. J. Charest, A. R. Long, and N. R. Morgan. Performance analysis of a 3D unstructured mesh hydrocode on multi- and many-core architectures. To appear in *International Journal for Numerical Methods in Fluids*.

Waltz, J., N. R. Morgan, T. R. Canfield, M. R. J. Charest, L. D. Risinger, and J. G. Wohlbier. A 3D finite element arbitrary Lagrangian-Eulerian method for shock hydrodynamics on unstructured grids. 2014. *Computers & Fluids*. 92: 172.

Waltz, J., N. R. Morgan, T. R. Canfield, M. R. J. Charest, and J. G. Wohlbier. A nodal Godunov method for Lagrangian shock hydrodynamics on unstructured tetrahedral grids. 2014. *International Journal for Numerical Methods in Fluids*. 76: 129.

Waltz, J., N. R. Morgan, T. R. Canfield, M. R. J. Charest, and J. G. Wohlbier. A Godunov ALE method for 3D unstructured grids. Presented at Nuclear Explosives Code Developers Conference. (Los Alamos, NM, 20-24 Oct. 2014).

Waltz, J., T. R. Canfield, M. R. J. Charest, N. R. Morgan, L. D. Risinger, and J. G. Wohlbier. Operator splitting and time accuracy in Lagrange plus remap methods. Presented at Conference on Numerical Methods for Multi-Material Fluid Flow. (San Francisco, CA, 2-6 Sep. 2013).

Waltz, J., T. R. Canfield, N. R. Morgan, L. D. Risinger, and J. G. Wohlbier. Verification of a three-dimensional unstructured finite element method using analytic and manufactured solutions. 2013. *COMPUTERS & FLUIDS*. 81: 57.

Waltz, J., T. R. Canfield, N. R. Morgan, L. D. Risinger, and J. G. Wohlbier. Manufactured solutions for the three-dimensional Euler equations with relevance to Inertial Confinement Fusion. 2014. *Journal of Computational Physics*. 267: 196.

Wohlbier, J. G., L. D. Risinger, T. R. Canfield, M. R. J. Charest, N. R. Morgan, and J. Waltz. Programming for modern architectures in the CHICOMA hydrocode. Presented at Conference on Numerical Methods for Multi-Material Fluid Flow. (San Francisco, CA, 2-6 Sep. 2013).

Empowering the Expert: Machine Learning with User Intelligence

Reid B. Porter
20130013DR

Introduction

Scientists and intelligence analysts are very good at understanding and exploiting the specialized datasets with which they work; the problem is that there is too much of this data for them to look at. Data processing tools help to clean up, filter and identify the most relevant subsets of data, but recent developments in machine learning have indicated that there is a grand opportunity to dramatically enhance the efficiency and accuracy of this process, by involving the user in a more interactive dialog.

Traditional machine learning employs a fixed set of labels, supplied up-front by the user, to optimize data processing tools before they are applied to a larger dataset or data archive. This approach has proven successful both in theory (rigorous proofs) and in practice (commercial applications). Machine learning with user intelligence pushes the state of the art in two directions.

From up-front learning to interactive learning

Traditional machine learning tools stop when the human steps in. This means the expert is still the bottleneck in data exploitation: spending too much time in tedious and repetitive post-processing tasks and not enough time on validation and research. Machine learning with user intelligence starts when the human steps in, and tools are a force multiplier, where the user's intelligence is the force to be multiplied, not an expense to be minimized.

From label learning to relational learning

Machine learning with user intelligence formalizes the interactive dialog with relational objects, stated in terms of motifs, clusters, alignments, matches and other generalizations of standard labels. By providing additional interface "bandwidth" between the domain expert and the data processing tool (and thus creating a better expression of the dialog in terms of graphical models), higher quality associations are produced, and more ef-

fective tools can be built.

Benefit to National Security Missions

This project empowers scientists and defense analysts to exploit specialized data in less time, and with greater accuracy, both by automating tedious and repetitive tasks and by enabling them to focus on validation and higher-level objectives. This general capability will be valuable to a large number of government agencies and missions. This project will also develop specific tools for (at least) two LANL applications:

Nuclear Material Forensics

Experts draw upon a vast understanding of the nuclear fuel cycle to quantify spectroscopy images, but they spend weeks each year manually correcting tool estimates of particle and grain boundaries. This project's image quantification advances will be valuable to DOE, DHS, and DOD.

Cyber-security

Analysts draw upon a deep understanding of the computer network as well as attacker behavior to determine if anomalous network traffic requires further investigation. However there is simply too many anomalies for analysts to perform even the most cursory triage. This project's cyber-security tools will be valuable to DOE, DHS and DOD, in particular for the protection of the NNSA complex itself.

Progress

In March of this year we hosted a mini-workshop on Interactive Machine Learning as part of the project appraisal. The two day event attracted 8 external speakers from industry (Google, Microsoft Research), academia (Caltech, Cornell, CMU, Indiana and UCSC) and government (JPL) who are at the forefront of Interactive Machine Learning. All participants were engaged, and we believe the event was productive and successful. Spe-

cifically, it helped our team develop a new collaboration with Indiana University in the area of Interactive Relational Learning. We are hosting an Indiana University PhD student in this area over the summer, and he is helping apply Indiana's expertise in these methods to LANL applications.

In other work, progress continued along the two main technical thrusts that we articulated in our roadmap / review article on Interactive Machine Learning that was published at the start of this year. We call the first thrust the 'Training Dialog', and it moves us from up-front learning to interactive learning (as described in the project description). Progress included:

- We presented our experiments comparing 'user-in-the-loop' training to traditional batch learning at the Visualization and Data Analysis Conference (VDA-2014), and received a Best Paper award. An extended version of this paper is in preparation for the Journal of Information Visualization.
- We developed a framework for Matched Pair machine learning that can potentially expand the range of tools and applications for Interactive Machine Learning and showed that in a plume detection application learning in the deployed environment outperformed learning offline.
- We also derived and implemented a set of learning methods, which unlike popular methods, solve supervised classification, robust (min-max) classification, Neyman-Pearson detection, anomaly detection and hemi-supervised classification with the same time and memory complexity. We used these methods to develop a hemi-supervised Neyman-Pearson detector to find encrypted chat traffic in cyber network traffic. The resulting detectors significantly outperformed traditional signature based detectors on real computer network traffic. In the next year we plan to use these methods within a prototype interface we have developed with the LANL Cyber-security team for user-in-the-loop triage of network traffic anomalies.

We call the second thrust the 'Training Vocabulary, and it moves us from label learning to relational learning (as described in the project description). Progress included:

- We developed a new mechanism to incorporate expert knowledge into Bayesian network structure learning algorithms. This was presented at the Los Alamos Postdoc Research Day and received a Best Poster Award.
 - We developed a new graph-based optimization technique for finding optimal epitope coverage in aligned sequences, and presented it at the Conference on Data Analysis, where we also received a Best Poster Award.
- We continued to develop theory and algorithms for the interactive image quantification prototype. We identified and formalized the interactions of most interest, which we call Semantic Interactions and they include: Labeling, Grouping, Ungrouping and Matching. We extended our learning to merge (group) algorithms from Year 1 into two new algorithms that enable us to learn from Labeling and Ungrouping. We call these algorithms Deep Max Min Networks and Deep Segmentation Networks respectively. Initial results were presented at our March workshop and publications are in preparation. We also recently made a new connection between supervised classification and perfect matchings which may help us develop new methods for the 'Matching Interaction'.
 - We also continued to make theoretical advances on Loopy Belief Propagation algorithms. Specifically we developed a Bootstrap Belief Propagation method that is exact for perfect matchings on bipartite graphs, and bounded for more general graphs.
 - We also applied Loopy Belief Propagation to a number of image problems relevant to the Labeling interactions, and compared its performance to a number of other approximate inference methods including Pseudo-Likelihood and Mean-Field approaches.

Building on the LDRD we secured new projects from DHS DNDO and the Intelligence Community. Both of these projects involve specialized analysts (in the DNDO project, chemists and microscopists, and in the IC project, non-proliferation and arms control experts). The methods we are developing for interactive image quantification and interactive network alarm triage are directly applicable to the DNDO and IC analysts respectively, and we are identifying opportunities to develop these programs further.

Future Work

Task: Develop methods for structured output prediction.
Goal: Efficient and general purpose learning algorithms to support increased user interaction.

Task: Develop interactive learning strategies for Graphical Models.

Goal: Algorithms that are robust to missing data and/or limited training examples.

Task: Identify and develop efficient strategies for combining inference and learning.

Goal: A better understanding of the accuracy and robustness of interactive learning with graphical models.

Task: Implement initial tools for image quantification and cyber-security applications.

Goal: Software that domain experts can use on practical datasets and an experimental platform for the project.

Task: Develop synthetic and benchmark experimental frameworks for interactive learning.

Goal: An ability to evaluate the accuracy and utility of tools for practical applications at various levels of interaction.

Conclusion

Our goal is to provide a general framework for data processing tools that directly targets the post-processing bottleneck. We emphasize graphical models in this development, as these provide a balance of rigor and flexibility on the learning front and domain adaptability on the interactivity front. An additional goal is to develop new tools, optimized for specific applications in nuclear material forensics and cyber-security, where there is a critical need to make data exploitation more accurate and more efficient.

Publications

Burr, T., and A. Skurikhin. Conditional Random Fields for inverse problems in structured data. 2014. Encyclopedia of Information Science and Technology, 3rd Edition Encyclopedia of Information Science and Technology, 3rd Edition.

Burr, T., and A. Skurikhin. Pseudo-likelihood inference for Gaussian Markov Random Fields. 2014. Statistics Research Letters Statistics Research Letters. 2 (3): 63.

Chertkov, M., A. E. Gelfand, and J. Shin. Loop Calculus and Bootstrap-Belief Propagation for Perfect Matchings on Arbitrary Graphs. Presented at International Meeting on 'Inference, Computation, and Spin Glasses'. (Sapporo, Japan).

Gelfand, A. E., J. Shin, and M. Chertkov. Belief Propagation for Linear Programming. Presented at IEEE International Symposium on Information Theory (ISIT). (Istanbul, Turkey).

Harvey, N., and R. Porter. User-Driven Sampling Strategies in Image Exploitation. Presented at IS&T / SPIE Visualization and Data Analysis VDA'2014. (San Francisco).

Harvey, N., and R. Porter. User-Driven Sampling Strategies in Image Exploitation. 2014. Information Visualization-Information Visualization.

Johnson, J., D. Oyen, P. Netrapalli, and M. Chertkov. Learning Planar Ising Models. Presented at In revision.

Loxley, P.. Learning dictionary statistics from natural images. Presented at Neural Computation.

Matteoli, S., M. Diani, and J. Theiler. An overview of background modeling for detection of targets and anomalies in hyperspectral remotely sensed imagery. 2014. Selected Topics in Applied Earth Observations and Remote Sensing (JSTARS) Selected Topics in Applied Earth Observations and Remote Sensing (JSTARS). 7: 2317.

Odom, P., T. Khot, R. Porter, and S. Natarajan. Knowledge Based Probabilistic Logic Learning. Presented at AAAI'15..

Oyen, D.. Discovery of Bayesian network structure from data and prior knowledge (poster). Presented at Conference on Data Analysis (CoDA). (Santa Fe, NM).

Oyen, D.. Discovery of Bayesian network structure from data and prior knowledge (poster). Presented at LANL Post-doc day.

Oyen, D., A. Niculescu-Mizil, R. Ostroff, and A. Stewart. Controlling the Precision-Recall Tradeoff in Differential Dependency Network Analysis. 2014. Nature Medicine Nature Medicine.

Oyen, D., and T. Lane. Bayesian structure discovery of multitask Bayesian networks. 2014. Knowledge and Information Systems Knowledge and Information Systems.

Oyen, D., and T. Lane. Bayesian discovery of multiple Bayesian networks via transfer learning. Presented at IEEE International Conference on Data Mining.

Porter, R., J. Theiler, and D. Hush. Interactive Machine Learning in Data Exploitation. 2013. Computing in Science and Engineering Computing in Science and Engineering. 15 (5): 12.

Porter, R., N. Harvey, and C. Ruggiero. Investigation of Segmentation Based Pooling for Image Quantification. Presented at IS&T / SPIE Image Processing: Machine Vision Applications VII. (San Francisco).

Porter, R., S. Lundquist, and C. Ruggiero. Learning to Merge: A New Tool for Interactive Mapping. 2013. In Algorithms and Technologies for Multispectral, Hyperspectral, and Ultraspectral Imagery XIX.

Porter, R., and B. Zimmer. Links Between Binary Classification and the Assignment Problem in Ordered Hypothesis Machines, . Presented at IS&T/SPIE Electronic Imaging. (San Francisco).

Porter, R., and C. Ruggiero. Data Integration and Entity Resolution: Challenges and Opportunities for Nonproliferation and Arms Control. Presented at Information Analysis Technologies, Techniques and Methods for Safeguards, Nonproliferation and Arms Control Verifi-

cation. (Portland, Oregon).

Sentz, K., and F. Hemez. The Future of Intelligent Systems for Safeguards, Nonproliferation, and Arms Control Verification. Presented at INMM Information Analysis Technologies, Techniques and Methods for Safeguards, Nonproliferation and Arms Control Verification. (Portland, OR).

Sentz, K., and S. Ferson. Natural Language of Uncertainty: Numeric Hedge Words. 2014. International Journal of Approximate Reasoning International Journal of Approximate Reasoning .

Shin, J., A. E. Gelfand, and M. Chertkov. A Graphical Transformation for Belief Propagation: Maximum Weight Matchings and Odd-Sized Cycles . Presented at NIPS 2013. (Lake Tahoe, NV, USA).

Skurikhin, A. N.. Learning tree-structured approximations for Conditional Random Fields. Presented at IEEE Applied Imagery Pattern Recognition Workshop.

Theiler, J.. Transductive and Matched-Pair Machine Learning for Difficult Target Detection Problems. Presented at SPIE 9088 (90880E).

Theiler, J.. By Definition Undefined: Adventures in Anomaly (and Anomalous Change) Detection. Presented at 6th IEEE Workshop on Hyperspectral Image and Signal Processing: Evolution in Remote Sensing (WHISPERS).

Theiler, J.. Spatio-spectral anomalous change detection in hyperspectral imagery. Presented at 1st IEEE Global Signal and Information Processing Conference .

Theiler, J.. Matched-pair machine learning . 2013. TechnometricsTechnometrics . 55: 536.

Theiler, J., and B. Korber. Epigraph: optimal epitope coverage for aligned sequences (poster). Presented at Conference on Data Analysis (CoDA). (Santa Fe, NM).

Vaish, R., S. Lundquist, R. Porter, and J. Davis. Crowd-sourcing bounding box annotations for computer vision . . Presented at HCOM 2013: Human computation. (Palm Springs, California).

Wallstrom, T.. Clustering Algorithms for HIV Antibodies (poster). Presented at Mini-Workshop on Interactive Machine Learning. (Los Alamos).

Wolpert, D., and D. Rajnarayan. Using Machine Learning to Improve Stochastic Optimization. Presented at Late breaking papers in AAAI.

Zimmer, B., and R. Porter. Hemisupervised Expectation maximization for rare category detection . 2014. Knowledge Discovery and Data MiningKnowledge Discovery and Data Mining.

Information-Driven Materials Discovery and Design

Turab Lookman
20140013DR

Introduction

The goal of this project is accelerated materials discovery by advancing the state-of-the-art statistical inference and optimization tools to find materials with desired or targeted properties. This data-centric approach narrows the possible search space for improved prediction by teasing out hidden information that is present in the data for known materials. Until very recently, new materials have almost exclusively been discovered by intuition and costly trial and error. However, literally overnight the use of simple statistical inference tools is just starting to define the new field of materials informatics. Our key innovation is an integrated design loop - an excellent example of the paradigm of codesign. It is a departure in how to think about the problem of Materials Discovery by using sophisticated information theoretic tools developed in various contexts including pattern recognition, operations research, bioinformatics, but applying them in a unique way to materials science issues. As an example, we will focus on the class of functional materials known as piezoelectrics. These are materials which produce a large strain if an electric field is applied, or a large polarization if stress is applied. The need is to find materials with a large response and high working temperatures. Such materials have numerous applications, from energy harvesting devices to sensors, and N. America has been gradually and continuously losing market share in these markets. These predominantly lead based compounds are now banned in many parts of Europe. Our objective will be to search for new lead free piezoelectrics. However, the paradigm we will develop will also be applicable to other materials classes with their own targeted properties, and where possible, we will examine within this project other related materials classes.

Benefit to National Security Missions

Accelerated materials discovery is of strategic importance and relevance to DOE/SC initiatives. Moreover,

the development of information science predictive tools to enable accelerated materials discovery is also a fundamental aspect of innovation in the above agencies. These tools are based on machine learning methods and are widely applicable to fields such as pattern recognition, statistical analysis and operation research, areas that are also of interest to these agencies. Our focus in this proposal is to demonstrate the new capability on the class of materials known as piezoelectrics and other functional materials. These are of interest to DOE/SC as they find applications as sensors and energy harvesting devices. More broadly, we will pioneer a new approach to materials discovery using information science predictive tools that will impact all missions that depend on materials, including the weapons program. The design loop we propose is also an example of the paradigm of codesign (which is gaining greater traction within DOE, for example,) - where learning a "model" is performed iteratively guided by experiments and computer calculations, which in turn are guided by statistical analysis.

Progress

The project, initiated 10/1/14, is an interdisciplinary project with IS&T and materials aspects. The key elements are to demonstrate materials design by using materials data on complementary materials where available, by performing experiments and calculations as part of the design and data acquisition strategy and, and by using and developing information science tools. We consider these aspects below.

Information Science

Previous analysis of materials data, e.g. for piezoelectrics, did not take into account uncertainties in predictions. By using bootstrap methods from the statistical sciences, we have not only validated previous findings, but have improved predictions of transition temperatures that agree much better with experimental findings. The merit of this work is that it emphasizes the impor-

tance of uncertainty quantification in materials design – an aspect largely ignored.

We used machine learning tools, such as support vector regression, for the first time on extensive materials data on perovskite compounds. Over the years, a structural stability map has been proposed by physicists to predict a priori whether a new compound will be stable or not. Such a classification, with hand-drawn boundaries between compounds, does not provide any idea of out-of-sample errors, a key yard-stick for determining how predictive a model can be. Our machine learning analysis, using cross validation, not only reproduces the existing classification but also predicts out-of-sample errors. We are also able to show how other features or descriptors of the data (that have not so far been considered by others) can also successfully classify the same data.

Prompted by procedures used in genomics, we have generalized a method for data visualization published by Tsafirir et al. [Bioinformatics 21, 2301 (2005)] and applied it to the datasets on hand. This method produces a visual representation of the clustering among correlated materials or features. The analyses shows that some features in the data mask the ability of others to generate physically natural clustering amongst the materials. This initial study prompted us to explore new machine learning methods called collective learning for feature reduction. These methods have previously not been used in the sciences and have the advantage of showing multi-relational ships amongst the data and will provide us with a means to construct prior probabilities for use in Bayesian analyses.

We have demonstrated a component of our proposal – adaptive experimental design- by using the knowledge gradient method to predict estimates of displacements for many ions for which ab initio data is not available.

We have written a manuscript entitled “Optimal Bayes Classification of stochastic dynamics”. Our classification approach goes beyond that of Dalton and Dougherty in that we are not restricted to Gaussian Processes, we make a connection with the well understand “Bayes decision function” approach and this sets the stage for applying Bayesian techniques to materials data.

Materials Science

To discover new lead free piezoelectrics, we have formulated a design strategy to use appropriate end components of a solid-solution. These components need to be mixed in specific volume fractions. The design space is therefore large. We synthesized several bulk ceramic compounds with varying fractions of components in order to build a

data base of 11 phase diagrams, and by down selecting certain features, a learning model has been constructed to make predictions on volume fractions of components that will optimize the slope of the morphotropic phase boundary (MPB) – a key design criterion as this is where the property-piezoelectricity is a maximum. Three compounds have been synthesized, based on our predictions, and these compounds have measured characteristics consistent with our model. It is remarkable that the model is linear. Further experiments in the target window are being performed. Ab initio calculations are also ongoing to acquire data and identify key physics to feed into the domain knowledge.

Ab initio calculations have been performed to down select substrates and film compositions to fabricate and characterize layered non lead piezoelectric systems. This will drive experiments at MPA.

We have identified a new materials design system for further study on which we can perform experiments and ab initio work. This is the layered electrocaloric material system important for energy applications– whereby a change in temperature is obtained by applying an electrical field.

Future Work

The materials design problems we have so far established in FY14, for bulk and layered materials, will be forcefully pursued so that we continue to iterate between the synthesis, characterization and machine learning tasks. The bulk materials will use standard ceramic techniques and the layered compounds will use pulsed laser deposition techniques.

Abinitio calculations in bulk and on layered systems will be performed as a means to not only integrate with our defined materials systems and experiments, but also to generate data towards using machine learning on calculation/synthetic data.

We will continue to apply and develop the machine learning approaches we are using on our materials data. It has become apparent that there are significant challenges in dealing with small materials data sets (where powerful machine learning tools are not applicable), with appropriate feature selection, and with applying materials domain knowledge. To expand our data sets, we will explore the idea of “semi-supervised learning”, whereby a small labeled data set can be augmented with a potentially much larger *unlabeled* data set. The performance is better than traditional learning approaches, but incorporation of more materials domain knowledge will be important to meet our overarching goals of targeted materials

discovery. We will also lay the foundations of a Bayesian approach in materials science which will provide a robust analysis tool for materials science.

Although we have executed only parts of our proposed design loop so far in FY14, one of our goals will be to exercise this loop using an extensive database that allows for a large, virtual space of possible compounds with targeted properties. We will use methods such as knowledge gradient and its variations, which we have already begun to refine.

Conclusion

If successful, we will establish a new paradigm for addressing complex optimization problems that include multiple sources and choices to incorporate domain knowledge. Further, we will have developed tools and algorithms to deal with error estimation, with experimental design and employing materials domain knowledge in machine learning. Our success will be measured by our discovery of new materials with desired properties and greater insight into the dominant mechanisms (structure-property relationships) underlying materials phenomena. A main deliverable will be an Information Science & Technology based materials discovery capability for accelerated materials discovery.

Publications

Gubernatis, J.. Data Visualization and Structure Identification. 2014. LA-UR-14-22628.

Lookman, T.. Heterogeneities, The Mesoscale and Multifunctional Materials Codesign: Insights and Challenges. 2014. In *Mesosopic Phenomena in Multifunctional Materials*. Edited by Saxena, A., and A. Planes. Vol. 198, First Edition, p. 57. Berlin: Springer.

Pilania, G., T. Lookman, and J. Gubernatis. Structure classification and melting temperature prediction in AB solids via machine learning. 2014. *Physical Review B* -preprint.

Pilania, G., and T. Lookman. Electronic structure and biaxial strain in RbHgF₃ perovskite and hybrid improper ferroelectricity in (Na,Rb)Hg₂F₆ and (K,Rb)Hg₂F₆ superlattices. 2014. *Physical Review B (Condensed Matter and Materials Physics)* . 90 (11): 115121.

Next Generation Quantum Molecular Dynamics

Anders M. Niklasson
20140074DR

Introduction

Quantum mechanical Born-Oppenheimer molecular dynamics (QMD) provides a highly powerful, but computationally expensive, multidisciplinary tool to predict, understand and design materials and processes directly from the fundamental principles of quantum physics. Merging QMD with future extreme-scale computing therefore holds the promise of a major paradigm shift in materials science, chemistry, and biology. Unfortunately, this potentially revolutionary opportunity will never be realized without a radical re-design of current approaches to QMD, overcoming a number of interconnected fundamental shortcomings. Based on several LANL-unique innovations, including a conceptually new graph-based approach to quantum mechanics, we propose a major coordinated interdisciplinary effort to develop a truly transformative computational framework for a new generation QMD that is specifically tailored for extreme-scale computing on heterogeneous architectures and allows simulations for time and length scales that are multiple orders of magnitude beyond current capacity. A key element of the proposed work is the development of a radical alternative to the traditional computational algorithms that are unsuited to large-scale simulations. Our new graph-based approach for solving the electronic structure problem will enable us to combine, for the first time, high on-node computational efficiency with massive parallelism for QMD simulations, including on-the-fly interrogation of the electronic degrees of freedom for visualization or quantum response properties. We will develop and demonstrate this capability on two testbed applications (involving aspects of nuclear fuels, and protein structures and dynamics) where classical MD methods are inadequate or fail, and where QMD simulations have thus far been too expensive. This unique computational capability will strengthen LANL's leadership in numerous mainstream priority areas in materials science, chemistry and biology, and it will have a lasting multidisciplinary impact on diverse applications that advance our missions.

Benefit to National Security Missions

This project will provide a new capability that will (a) benefit our mainstream Laboratory missions in weapons science and energy security by enabling the predictive modeling of fundamentally quantum mechanical processes occurring in energetic materials, nuclear fuels, actinide chemistry, and fuel cells; and (b) provide a competitive advantage to LANL as we target new opportunities in emerging areas such as the Materials Genome Initiative, biofuels, and partnerships with industry. To give one example, equations-of-state and opacities in highly nonequilibrium conditions important to the weapons mission rely increasingly on quantum mechanical molecular dynamics simulations, but are constrained by the small length and short time scales presently accessible. A number of recent DOE workshops have highlighted "the need to advance theoretical models of physical and chemical objects and processes, and to develop algorithms that effectively enable those models to be simulated on modern computing systems", in particular: 1) advancing the speed and accuracy for quantum chemistry modeling on extreme-scale platforms, and 2) bridging length and time scales to enable seamless multiscale chemical reactivity modeling.

Progress

Quantum-based models of interatomic bonding based explicitly on electronic structure provide by far the most accurate and reliable descriptions of molecules and solids. Molecular dynamics (MD) is a powerful and broadly applied atomistic simulation methodology, the performance of which is dependent on the rapid computation of interatomic forces. The project will unite quantum-based models of interatomic bonding with large-scale, long-duration MD simulations by slashing the computational burden associated with the computation of interatomic forces in the former. The project is on-track to fully meet or exceed all of its deliverables for its first year.

Our primary breakthroughs both involve the development of new methods for reducing the complexity of electronic structure calculations from cubic scaling with the number of atoms, $O(N^3)$, to linear scaling, $O(N)$. While we have previously shown $O(N)$ performance in Born-Oppenheimer MD using sparse matrix algebra, our algorithm was limited to execution on a single CPU core. A parallel and highly efficient algorithm has been developed in sparse matrix algebra that scales nearly ideally with the number of CPU cores. We have also ported this code to graphics processing units (GPUs) using Nvidia's cuSPARSE library. A radically new approach to parallelizing $O(N)$ electronic structure calculations in an MD simulation has also been developed. This is based on a novel graph-based partitioning of the workload that we believe will scale well on even the largest computational platforms.

The graph-based partitioning of the density matrix construction in electronic structure theory permits trivial parallelism by identifying localized interactions between atoms. In some respects it is a divide-and-conquer approach that avoids the pitfalls associated with a distance-based cut-off on the range of matrix elements. Furthermore, we have developed mathematical proofs that our new approach leads to small and controllable errors, unlike traditional divide-and-conquer algorithms.

Our primary deliverable a software package, PROGRESS, (Parallel, Rapid $O(N)$ and Graph-based Recursive Electronic Structure Solver) that in principle can be compiled into any electronic structure code. The development of PROGRESS is well underway and combines standalone code, code implemented in LATTE, as well as algorithms for GPUs based on Nvidia's libraries or our own kernels in OpenCL.

The accelerated molecular dynamics (AMD) techniques pioneered by Voter and co-workers require very rapid force computations (< 0.1 s) and as a result the combination of AMD with electronic structure theory has been a challenging goal. We have performed the first proof-of-principal parallel replica AMD simulations of shock-induced chemical reactions using the LATTE code that included novel methods for detecting the onset of chemistry. We have also implemented three different thermostats in LATTE (Langevin, Andersen, and Nose-Hoover) that enable us to run trajectories in the canonical ensemble in which AMD is usually performed. Here, the combination of thermostats with fast, low-prefactor microcanonical extended Lagrangian Born-Oppenheimer MD has now been developed and demonstrated for the first time.

The LATTE code was extended to enable the use of traditional reciprocal space methods in the construction of the

density matrix. The use of k-space integration is required in the development of a new atomistic model for uranium dioxide - one of our test-bed applications for PROGRESS. Access to k-space integration has also enabled us to develop new methodologies for the parameterization of tight binding models via matching electronic densities of states to the results of first principles calculations. Most significantly, this approach makes the automated, machine-based optimization of interatomic potentials possible - an area of research we are currently pursuing.

The application of quantum-based MD to biomolecular systems is another test-bed for PROGRESS. Here we have focused mainly on the DFTB+ code developed by Thomas Frauenheim's group in Germany. We found that semi-empirical calculations of the electron density required for the computation of X-ray diffraction patterns compared very favorably with much more expensive first principles calculations. We are working with Frauenheim's group on interfacing DFTB+ with PROGRESS to accelerate the performance of this heavily used code.

Finally, a GRA is working with us on the development of a novel scheme for switching between fast, zero electronic temperature $O(N)$ methods and finite electronic temperature algorithms on-the-fly in order ensure smooth and continuous potential energy surfaces during the making and breaking of covalent bonds. We are currently making excellent progress toward this goal.

Future Work

Building on our progress during year 1, our tasks and goals for year 2 include:

- The exploration, development, and proof-of-principle application of schemes for the efficient partitioning of computational work from a graph theoretical approach
- Application of accelerated MD to organic systems (liquids and biological) based on both adaptive self-consistent field calculations and parallelism
- Investigation of the utility of TB+U in obtaining good electronic densities of states for actinide-based materials.
- The continued development of the PROGRESS package to multi-core and multi-node architectures, including graphics processing units.
- The continued exploration of sparse matrix methods on traditional architectures as well as graphics processing units (via the cuSPARSE libraries)
- Further work on the computation of charge densities from density functional tight binding for the simulation of protein structures and associated X-ray diffraction patterns.

Conclusion

Our chief result will be a general, interdisciplinary, computational capability that will enable us to analyze, understand, predict and design materials and processes directly from quantum theory, at time and length scales that are multiple orders of magnitude beyond current capacity. This will be delivered in the form of the portable and openly available program package that can be used with a broad class of electronic structure codes. The development will be guided through two testbed application systems of LANL mainstream mission relevance: 1) protein structures and 2) nuclear fuels.

Publications

Cawkwell, M. J.. Fast quantum molecular dynamics simulations of shock-induced chemistry in organic liquids. Invited presentation at American Physical Society March Meeting 2014. (Denver, 3-7 March 2014).

Cawkwell, M. J., A. M. N. Niklasson, and D. M. Dattelbaum. Extended Lagrangian Born-Oppenheimer molecular dynamics simulations of the shock-induced chemistry of phenylacetylene. 2014. To be submitted to the Journal of Chemical Physics.

Cawkwell, M. J., J. D. Coe, S. Yadav, X. Y. Liu, and A. M. N. Niklasson. Extended Lagrangian formulation of charge-constrained tight binding molecular dynamics. *Physical Review B*.

Cawkwell, M. J., M. A. Wood, A. M. N. Niklasson, and S. M. Mniszewski. Computation of the density matrix in parallel on multiple graphics processing units. *Journal of Chemical Theory and Computation*.

Martinez, E., M. J. Cawkwell, A. F. Voter, and A. M. N. Niklasson. Thermostating extended Lagrangian Born-Oppenheimer molecular dynamics. 2014. To be submitted to *Journal of Chemical Physics*.

Mniszewski, S. M., M. J. Cawkwell, J. Mohd-Yusoff, N. Bock, T. C. Germann, and A. M. N. Niklasson. Parallel linear scaling calculation of the density matrix in electronic structure theory. 2014. To be submitted to *Journal of Chemical Theory and Computation*.

Niklasson, A. M. N., M. J. Cawkwell, E. H. Rubensson, and E. Rudberg. Canonical density matrix perturbation theory. 2014. To be submitted to *Phys. Rev. B*.

Niklasson, A. M. N., and M. J. Cawkwell. Generalized extended Lagrangian Born-Oppenheimer molecular dynamics. Accepted for publication in *Journal of Chemical Physics*.

Optimization and Control of Dynamic Networks

Robert E. Ecke
20140565DR

Introduction

Network science research has been primarily focused on the simplification of dynamic graphs to static graphs and their topological characteristics. But processes on networks such as the spread of a virus on a social network, traversal through a cyber network, and cascading failures in a power grid are critically dependent on the dynamic nature of the underlying network.

These dynamic graphs are at the heart of technological and scientific problems in electrical power grids. Deployment of new technologies, such as renewable generation and electric vehicles, is rapidly transforming electrical power networks by coupling previously distinct spatiotemporal scales and challenging traditional approaches for designing, analyzing, and operating power grids. The interactions of spatiotemporal scales in power systems are pushing the limits power engineering best practices and we need to develop general complex system models at the appropriate level of network detail necessary to isolate and analyze the relevant static, dynamic, and stochastic phenomena.

Computer networks are also inherently dynamic and non-stationary. Capturing the dynamics of user activity through coarse-level and high-fidelity modeling is critical to understanding normal activity and detection of anomalous activity. Only recently has a network-wide (graph theory) viewpoint been taken.

The CNLS brings a unique perspective in the integration of interdisciplinary approaches and ideas to the subject of network science. The CNLS has been a leader and innovator in Information Science and Technology. In particular the CNLS has helped provide new approaches in theory and modeling of networks for more than 10 years. The CNLS has helped nucleate efforts at LANL for applications of networks in neurocomputation, smart grid, and cybersecurity.

Benefit to National Security Missions

Information Science and Technology is a Laboratory strategic pillar that touches a broad spectrum of science at LANL from discovery science to pivotal program needs. This proposal directly addresses Complex Networks capabilities through the modeling of dynamic networks and with applications to cybersecurity and power systems ("smart grids").

This proposal develops core information science and technology capabilities needed to address the open questions of the Office of Electricity that intersect with the scientific goals of DOE's Office of Advanced Scientific Computing Research (ASCR) Applied Mathematics Program such as uncertainty quantification in complex engineered networks.

This project will innovate with basic research supporting LANL's internal cybersecurity programs and Global Security programs. Effective cyber defense of the weapons complex is essential to its security and effectiveness.

Progress

We studied random intersection graphs which are random bipartite graphs projected onto one set of the bi-partition. Such graphs capture the bipartite nature of many real world networks, such as some cyber networks, and social networks. Notably, they allow the description of sparse random graphs with tunable clustering, while at the same time are mathematically tractable. Recent work in network science has explored the "tree-like" properties - such as hyperbolic geometry, k -core decomposition, and tree decomposition - of real world networks. We proved that the simplest model of random intersection graphs has unbounded hyperbolicity in the sense of Gromov.

We published the article by Garcia, Giani, Poolla "Partial state estimation for electricity grids," as part of the

Decision and Control (CDC), 2013 IEEE 52nd Annual Conference. Power system operators rely critically on state estimation for verification, fault detection and localization, and re-dispatch under contingency operations. In current practice, power system data within a control area such as voltages, phases, real and reactive power flows and injections, are relayed to the operator using SCADA systems. We formulated the problem as an over-determined weighted nonlinear least squares problem and used the formulation to explore techniques to accelerate state estimation. Our techniques, inspired by uncertainty quantification methods, compute state estimates at a small subset of buses using limited measurements from the power subsystem of interest.

We developed algorithms for placement of phasor measurement units to prevent unobservable attacks. This work was presented in the lecture “Phasor Measurement Unit Placement for Unobservable Attack Detection” at the International Conference on Critical Infrastructure.

Using a partial differential equation model for the electrical load flow, we have analyzed the induction motor dynamics in a distribution feeder under the effect of a fault/disturbance. We have found that the steady state behavior of the rather complex dynamics of inductor motor stalling in a distribution feeder can be predicted with reasonable accuracy at the end of a fault. This result could be used to accurately estimate the critical fault clearing time to avoid instability. This work was presented in a poster titled “Critical Clearing Times and Simplified Models for Fault-Induced Delayed Voltage Recovery.”

Future Work

For FY15 we will seek the following goals:

- Create comprehensive ODE/PDE models for power systems that incorporate the different devices and controls that are making inroads into electrical distribution networks, e.g., PV systems, electric vehicle charging, and frequency responsive loads. The ODE/PDEs approach will address the interaction of emergent phenomena arising from the interaction of new smart-grid components.
- Develop reduced-order stochastic models of the short-term dynamics that are key to understanding power outage cascades. We will develop new approximate statistical methods to capture underlying interactions and scale separations and seek effective parallel control algorithms to mitigate cascades.

We will model cybersecurity systems as dynamic networks and seek to incorporate rich-data such as time-series

of observations of authentication, web-surfing, or file-sharing. We will develop techniques including hierarchical models to handle the statistics of the bursty network communication patterns commonly observed.

Conclusion

We expect to develop research results with three interlocking themes:

Dynamic Networks

Develop models and algorithms for temporal random graphs; seek theorems for connectivity and reachability in the models; and explore the range of possible temporal correlation patterns.

Power Systems

Create comprehensive ODE/PDE models for power systems; develop reduced-order stochastic models of network power-outage cascades; develop mathematical tools to capture system energy and thermal states.

Cybersecurity

Model as dynamic networks; develop techniques including hierarchical models to capture statistics of bursty network communication patterns; create inference methods and fit cyber authentication network data to the temporal random graph models.

Publications

- Farrell, M., T. Goodrich, N. Lemons, F. Reidle, F. Villaamil, and B. Sullivan. Hyperbolicity, degeneracy, and expansion of random intersection graphs. 2014. arXiv.
- Generous, N., G. Fairchild, A. Deshpande, S. Y. Del Valle, and R. Priedhorsky. Global disease monitoring and forecasting with Wikipedia. . 2014. arXiv.
- Kundu, S., and I. A. Hiskens. Overvoltages due to Synchronous Tripping of Plug-in Electric-Vehicle Chargers Following Voltage Dips. 2014. IEEE Transactions on Power Delivery. 29 (3): 1147.
- Kundu, S., and I. Hiskens. Nonlinear dynamics of hysteresis-based load controls. To appear in The 19th World Congress of the International Federation of Automatic Control. (Cape Town, South Africa, 24-29 Aug. 2014).
- Tapia, A., N. LaLone, E. MacDonald, R. Priedhorsky, and M. Hall. Crowdsourcing rare events: Using curiosity to draw participants into science and early warning systems. . To appear in International Conference on Information Systems for Crisis Response and Management (ISCRAM), 2014. (University Park, Pennsylvania, 18-21 May, 2014).

Turcotte, M.. Detecting localised anomalous behaviour in a computer network . To appear in Advances in Intelligent Data Analysis XIII, LNCS 8819 . (Leuven, Belgium, 30 Oct - 1 Nov, 2014).

Yamangil, E., R. Bent, and S. Backhaus. Designing Resilient Electrical Distribution Grids. 2014. arXiv:1409.

Optimization Principles for Co-Design Applied to Molecular Dynamics

Stephan J. Eidenbenz
20110710DR

Abstract

We developed a framework for hardware-software codesign as a semi-formal optimization problem. While the modeling framework is applicable to other problem domains, we focused on accelerated molecular dynamics (AMD) as an application that features the need for computational scaling. We view codesign as search and selection from a vast space of hardware and software designs that map to performance metrics. The objective function that we optimized for has as main components run time (or computational rate), problem size, and hardware cost. We define software designs in a hierarchical fashion with the main hierarchy levels of Application/Problem, Model/Equations, Algorithms, and Software implementation, where changes to higher levels are more fundamental than lower level changes of, say, a specific data structure. The hardware architecture is defined as a hierarchical set of components that interact with each other and offer services to an application through operating system and system software. Our performance prediction methods model at different levels of detail, thus covering the trade-off space of accuracy vs. scalability in both time and size.

From our chosen applications domain perspective, our results have brought within reach atomistic simulation tools that enable the study of processes such as ductile spall failure under shock conditions and the evolution of radiation damage. Achieving this required a two order of magnitude increase in simulated time over current state-of-the art computing.

Background and Research Objectives

After many years of Moore's Law processor speeds have leveled out and advances in computational power are now coming from massive parallelization, architectural heterogeneity, and increasing programmer-level architectural complexity. In almost every scientific field, without radical modification of algorithms to adapt them to the hardware, harnessing the full theoretical speed

of next-generation computers will be impossible. As a specific example, consider the application focus of this proposal, molecular dynamics (MD) methods, a standard workhorse in materials science and many other fields. Given the linear scaling of MD with respect to the number of atoms, system size and total simulation time can in principle be traded for one another given a perfectly scaling MD code. Using a traditional parallel MD code based on spatial decomposition, i.e., where contiguous groups of atoms are assigned to each processor, this ideal scaling is compromised by two factors: first, for very large numbers of atoms per node and hence short simulation times, the total system size is limited by the available memory; second, for small numbers of atoms per node, the communication overhead required to pass the position of the atoms across the interfaces between domains severely limits the achievable simulation time. For infrequent-event systems, which make occasional transitions to a new state (e.g. the diffusive jump of a vacancy in a solid), accelerated molecular dynamics (AMD) methods developed at Los Alamos can be employed to reach longer time scales. The AMD methods, which are described below, are typically most effective for small systems of up to $\sim 10^4$ atoms. In the case of the parallel-replica dynamics (ParRep) method, many replicas of the entire system are evolved simultaneously and independently, eliminating the need for inter-domain communication except when a transition occurs. ParRep gives exact state-to-state dynamics if it is implemented carefully, and this re-casting of the work amounts to a parallelization of time. The chief overhead in ParRep is associated with the preparation of the new replicas after each transition, so for a system with very infrequent events, long-time simulations are possible

The severity of the problem facing us becomes obvious when we estimate the behavior of MD or ParRep on an anticipated realization (in say 2020) of an exascale machine with 10^8 processing cores (Fig. 1). The increased memory will allow simulations up to $\sim 10^{14}$

atoms for ps time scales, and ParRep for very small systems might reach second time scales if the events were very infrequent (once per 10 ns for 1000 atoms), but essentially no new territory is covered in the middle range. The important regime of 10⁶ to 10⁹ atoms for microseconds to milliseconds is still totally inaccessible, meaning we will have no direct way to simulate processes such as ductile spall failure, dislocation pileup and release at grain boundaries, or radiation damage annealing involving multiple cascades, all of which are important materials science problems and critical to the DOE mission. In short, if we do not find a new paradigm for implementing MD methods onto advanced computer architectures, critical problems in materials science that could in principle be addressed in a powerful way with MD or AMD will remain utterly out of reach for the indefinite future. We believe the answer to this problem lies in the development of a formal co-design capability that optimizes hardware and software simultaneously.

Scientific Approach and Accomplishments

The scientific approach and accomplishments are best presented along the two major tasks : (i) building the Accelerated Molecular Dynamics (AMD) simulator AMDSim and (ii) developing a detailed Profile-Parallelize-Predict (PPP) approach for automatic parallelization.

We have developed the AMDSim code suite, consisting of TADSim to simulate temperature accelerated dynamics simulations, and ParRepSim to simulate parallel replica dynamics simulations as well as several combinations and extensions of these two basic methods, such as speculative execution of transition branches, alternate variations of checking for transitions, multiple high-temperature settings.

The codes have been thoroughly tested and validated against the real code using a metallic surface diffusion system. The validation process took longer than we had anticipated due to a few software errors but also due to the physics of the studied system, which turned out to be more complex than we expected. We developed a model for the escape rates (e.g., a diffusive jump of an atom on the surface) that includes an additional temperature dependence to account for anharmonicity. We also found it was important to include a temperature dependence in the number of steepest-descent iterations required to detect transitions. With this more refined model of the physics built into the TADSim code, a very satisfactory set of validation results was obtained. After the validation period, we started large parameter scans.

AMDSim is the first member of a new class of tools called application simulators, parameterized fast-running proxies

of large-scale scientific applications using parallel discrete event simulation (PDES). Parameterized choices for the algorithmic method and hardware options provide a rich space for design exploration and allow us to quickly find well-performing software-hardware combinations.

The TADSim simulator models the Temperature Accelerated Dynamics (TAD) method, an algorithmically complex and parameter-rich member of the Accelerated Molecular Dynamics (AMD) family of molecular dynamics methods. The essence of the TAD application is captured without the computational expense and resource usage of the full code. We accomplish this by identifying the time intensive elements, quantifying algorithm steps in terms of those elements, abstracting them out, and replacing them by the passage of time. Our perhaps most spectacular result is the predicted scaling of a combination of ParRep and TAD, which is shown in Figure 2: ParRepTAD will achieve a speed-up of up to 100,000 over the traditional TAD method. ParRepTADSim is an application simulation of an unimplemented AMD method that combines two established AMD methods. ParRepTAD achieves speedups of more than 100,000 at a count of 1000 replicas, compare to the 1000 speedup of the base TAD method. ParRepTAD successfully uses thousands of replicas and thus compute cores, allowing us to trade off smaller speed-ups with smaller core counts as shown in the figure with the different plots lines for different replica counts

The PPP component is an automatic parallelization scheme of serial programs via a multi-step tool chain. The tool chain itself consists of several discrete components, some freely available open-source software (most significantly the LLVM compiler infrastructure), and some developed by this project. In brief: a program in any language that LLVM or GCC can accept (C, C++, Fortran, etc.) is transformed to the LLVM intermediate representation, then transformed to introduce and maximize parallelism, essentially by respecting exactly the data dependencies, and otherwise ignoring the control dependencies that are often largely artifacts of the sequential programming language. In this form the program exhibits a theoretically maximal degree of parallelism. Subsequent analysis and transformation schedules the instructions with respect to a processor budget, memory access constraints, data transfer costs, etc., in other words, optimally or near-optimally on an arbitrary, hypothetical computer architecture.

Typically the goal is to minimize make span--the time for all computations to complete, but other metrics are possible, such as total energy consumption. In this way we can answer such questions as "Given an architectural specification, what is fastest a given program could possibly run on it?" or "Given a program, what is the fastest it could run

with current semiconductor technology but with unlimited budget?” In the context of the whole project, this gives us the automated performance prediction needed in the co-design optimization loop. Independently, we believe that the PPP capability has the potential to be a game-changer in automated program parallelization.

Impact on National Missions

Our optimization framework consisting of the concept of an application simulator (such as AMDSim) and the automatic parallelization tool chain PPP provides the unique capability of co-designing hardware and software on a sound semi-formal basis. It will enable effective implementation of physics simulations on future novel computer architectures. For our molecular dynamics application domain, the framework is enabling us to reach regimes to study a wealth of poorly understood phenomena of critical importance to the lab mission, including nuclear weapons, energy systems, and armor, to name but a few.

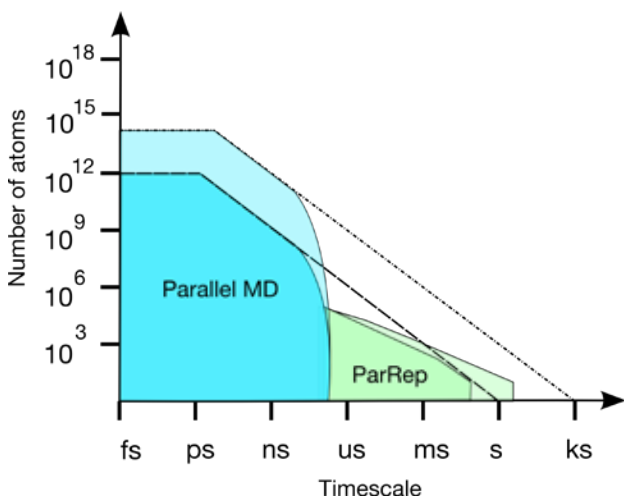

Figure 1. The need for codesign in Next Generation HPC Systems for (Accelerated) Molecular Dynamics

ParRepTADSim Results

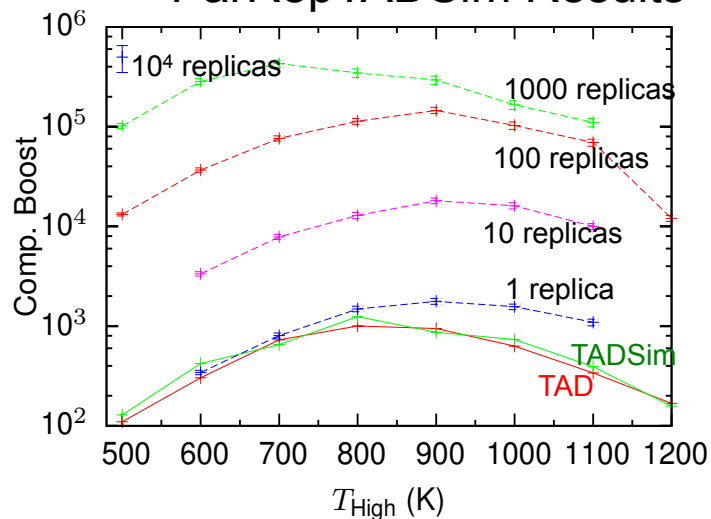

Figure 2. ParRepTADSim is an application simulation of an unimplemented AMD method that combines two established AMD methods. ParRepTAD achieves speedups of more than 100,000 at a count of 1000 replicas, compare to the 1000 speedup of the base TAD method.

Publications

Optimization Principles for Hardware/Software Co-Design with Applications in Molecular Dynamics. 2012. In Poster at Supercomputing conference SC'11. (Seattle, WA, 12-18 Nov. 2011). , p. 1. Seattle, WA: ACM.

Delengov, V., Y. Li, J. Thompson, and L. Kroc. Hardware-Software Codesign. 2012. Claremont Graduate University Mathematics Clinic - Final Report.

Eidenbenz, S., A. Voter, K. Davis, S. Mniszewski, D. Perez, N. Santhi, S. Thulasidasan, H. Djidjev, L. Gurvits, and C. Junghans. Optimization Principles for Codesign applied to Molecular Dynamics: Design Space Exploration, Performance Prediction, and Optimization Strategies. 2012. In DOE ASCR/ASC Exascale Research Conference 2012. (Portland, NY, 16-18, April, 2012). , p. n.a.. Portland, OR: DOE.

Eidenbenz, S., A. Voter, K. Davis, S. Mniszewski, D. Perez, N. Santhi, S. Thulasidasan, H. Djidjev, L. Gurvits, and L. Kroc. Optimization Principles for Hardware/Software Co-Design with Applications in Molecular Dynamics. 2011. Los Alamos National Laboratory Unlimited Release.

Eidenbenz, S., K. Davis, A. Voter, S. Mniszewski, H. Djidjev, L. Gurvits, C. Junghans, D. Perez, N. Santhi, and S. Thulasidasan. Optimization Principles for Computational Co-Design with Applications to Molecular Dynamics . 2012. Poster at LANL Materials Capability Review.

Eidenbenz, S., N. Santhi, S. Mniszewski, and M. K. Davis.

Performance modeling at Multiple Interacting Scales: hierarchical generalized instructions sets to move through different abstraction levels using stochastic substitution. 2013. LA-UR 13-24444.

Gurvits, L.. Simulating one Markov Process based on a Black Box for another: Rigorous Proofs. 2012. Draft version.

Kroc, L., N. Santhi, L. Kroc, V. Delengov, Y. Li, J. Thompson, and S. Eidenbenz. Optimization Principles for Arithmetic Functions in Hardware-Software Co-Design - Extended Abstract. 2012. In The Winter Simulation Conference. (Berlin, Germany, 9-12 December 2012). , p. 337. Berlin, Germany: SCS.

Mniszewski, S.. TADSim: Discrete Event Simulation of Temperature Accelerated Dynamics Performance. 2011. Los Alamos National Laboratory Unlimited Release Report.

Mniszewski, S. M., C. Junghans, A. F. Voter, D. Perez, and S. Eidenbenz. TADSim: Discrete Event-based Performance Prediction for Temperature Accelerated Dynamics. To appear in ACM Transactions on Modeling and Computer Simulation.

Mniszewski, S., S. Eidenbenz, A. F. Voter, D. Perez, and C. Junghans. Parametrized discrete-event-based application simulators for performance modeling. 2013. LA-UR 13-24386.

Santhi, N., M. K. Davis, and S. Eidenbenz. Graphical models and a scalable methodology for exascale performance prediction. 2013. LA-UR 13-24435.

Thulasidasan, S., S. Eidenbenz, and L. Kroc. Developing Parallel, Discrete Event Simulations in Python: First Results and User Experiences with the SimX Library. To appear in Proceedings of 4th International Conference on Simulation and Modeling Methodologies, Technologies and Applications, SIMULTECH 2014. (Vienna, Austria, August 28-30, 2014).

Williams, S., and S. Eidenbenz. Extensible design for multi-agent serial processes. 2013. LA-UR 13-27222 .

CoCoMANS: Computational Co-design for Multi-scale Applications in the Natural Sciences

Dana A. Knoll
20110737DR

Abstract

We have evolved a qualitatively new predictive-science capability exploiting emerging high-performance computer architectures for multiple national-security-critical application areas—including kinetic plasma simulation, and free-surface ocean simulation—by simultaneously evolving domain science, applied math and numerical methods, software, and hardware in an integrated computational co-design process. We have further developed new, self-consistent, two-way, scale-bridging methods that have broad applicability to the targeted science, will map well to emerging heterogeneous computing models (while concurrently guiding hardware and software to maturity), and provide the algorithmic acceleration necessary to probe new scientific challenges at unprecedented scales. The results of our project include 1) a paradigm shift in the pursuit of world-class science at LANL by bringing a wide spectrum of pertinent expertise in the computer and natural sciences in to play; 2) a computational co-design knowledge-base, built upon an evolving software infrastructure; and 3) a deeper understanding of, and experience-base with, consistent, two-way, scale-bridging algorithms.

Background and Research Objectives

Our goal has been to define, develop, and employ a computational co-design process, encompassing at one end, non-trivial computational physics problems, and at the other a range of current, emerging, and to some degree hypothetical, hardware architectures. This required defining at a high level the co-design process we followed, and in more detail, the methodology. The process broadly prescribes functional areas—domain science, numerical algorithms and solvers, computer science, and hardware (processor and node-level architecture)—and the communication and feedback among them. The methodology distills our philosophy for this largely uncharted territory. The results and deliverables of this project fall into three main categories: a paradigm shift in multi-scale physics on emerging architectures, a

knowledge base for computational co-design, and the development of a community—both internal and external—around LANL’s approach to co-design.

CoCoMANS is a computational co-design project with an algorithms focus. Our basic premise is that hierarchical algorithm development is key to gaining computational efficiency on next-generation architectures. This hierarchical approach is designed to match the hierarchy of these expected machines—vastly increased arithmetic ability with relatively stagnant network bandwidth. It is our view that traditional vendor interactions via proxy applications and effective “code porting” are important, but not sufficient, in achieving this goal. In the end, we advocate for new algorithm development that allows for effective use of emerging architectures and provides a clear advancement in predictive simulation—the proverbial “win-win.”

Scientific Approach and Accomplishments

People working in three main functional areas staffed our project team. First are the domain scientists whose main task is to build applications that generate “real” scientific results. Second are the people that focus on solvers and numerical algorithms that are then used to build domain science applications. Third, computer scientists are concerned with implementing the applications, solvers, and numerical algorithms in the most efficient manner on a variety of hardware platforms. Note that there is often significant overlap in these areas that facilitates our co-design process. For example, numerical algorithms people often have deep knowledge of multiple scientific domains and our computer science staff have detailed knowledge of many different hardware architectures.

We evolved a process of iterative refinement based on cyclical co-design interactions between these functional areas. Domain scientists have interacted with numerical methods experts to develop optimal multi-scale physics

algorithms. Computer scientists have implemented these methods on various hardware, run tests and experiments, and feed results back to the numerical methods staff who then may need to provide feedback to domain scientists. While co-design interactions naturally focus on “nearest neighbor” relationships, there must be some notion of the “big picture” to facilitate a broader co-design loop when necessary.

Our accumulated co-design knowledge base consists of artifacts created during the project life cycle. Most importantly, we have built a software infrastructure for HO codes that allows us to target multiple, architecturally divergent, hardware devices with a single source code base. This framework lets us express our algorithms at a level of abstraction that can be understood by a domain scientist (e.g. PDEs) while simultaneously allowing computer scientists to transparently generate efficient code for these varying architectures.

In addition, we have produced a persistent, organized, history of our co-design process. This history is first captured as an evolving source code repository of the many test codes we have written—from simple micro-benchmarks to our final compact applications. Second, we capture the tests we have run and their results, also tying these tests to the actual codes that were run to generate the test results. This combined knowledge base enables us to duplicate, partially or in total, our co-design iteration cycles for future, as yet unexplored, system architectures.

We have significantly advanced the concept of moment-based scale bridging algorithms which we have referred to as Higher-Order / Lower-Order (HO-LO) methods. We have two distinct yet closely related approaches to this idea. One that utilizes the Jacobian-Free Newton-Krylov (JFNK) method and the concept of nonlinear elimination. The other involves a Picard iteration between the HO and LO problem with the possible use of Anderson acceleration. Both approaches use a reduced space problem (LO) to algorithmically accelerate the convergence of the fine scale HO problem. Simultaneously, due to their hierarchical nature, the HO-LO algorithms map naturally to emerging architectures. This natural mapping allows us to maximize use of arithmetic capability while simultaneously minimizing data motion. In essence, we are maximizing our use of the plentiful resource, flops, while minimizing our use of the scarce resource, network bandwidth). Additionally, both HO and LO algorithms exploit multi-level parallelism wherever possible. These HO-LO algorithms have a much broader application base than what we have explored this far, especially within the LANL ASC program.

Within our plasma physics application we have clearly

demonstrated a “Win-Win”. Using the HO-LO approach we have developed a 2-D electromagnetic implicit PIC solver. This solver conserves energy and is not required to spatially resolve Debye lengths, all while being second order accurate in time. This is an algorithmic first, and very important. However, in addition, the approach allows for significant use of on-node flops with minimal node-to-node communication. With this 2-D compact app software in place, we are expecting a number of important new physics simulations to evolve while efficiently using emerging architectures.

For the most part, we have also achieved a “Win-Win” in free-surface ocean models with tracers driving thermohaline circulation. We have established that a modern JFNK-based solver, with nonlinear elimination and sub-cycling, can achieve second-order accuracy in time simulations using time steps noticeably larger than the standard split-explicit method. The standard split explicit method sub-cycles an explicit LO problem with in Picard iteration. Our new approach sub-cycles the HO problem within an implicit LO solver. It has been demonstrated that as a result of the hierarchical nature of the algorithm, significant on-node HO solver flops can be achieved for minimal node-to-node HO problem communication. This will be crucial for the efficient use of these emerging architectures.

Finally, we have defined a plan for moving forward with these concepts within the LANL ASC program with the goal of impacting the next generation integrated codes. An argument has been made for evolving the HO-LO concept to multi-physics simulation involving multiple HO problems. An advanced HO-LO algorithm could enable a task-based parallelism programming model where individual HO problems could be executed concurrently. This is in direct contrast to the current ASC multi-physics approach where individual HO problems are advanced sequentially. This latter approach will most likely run into severe synchronization & communication bottlenecks that will limit efficient use of emerging architectures. It remains to be seen if the LANL ASC program will invest in the development required for this advanced HO-LO concept.

In addition to these accomplishments this project has supported the research of three US citizen PhD students. These students are Jeff Willert (Applied Math, NCSU, Spring 2013), Will Taitano (NucE, UNM, Spring 2014), and Chris Liebs (Applied Math, Univ. of Colorado, expected Fall 2014). Two of these PHD students (Willert and Taitano) are currently LANL post-docs both involved with the LANL ASC program.

Impact on National Missions

The architectural changes in computing systems that we addressed in CoCoMANS are expected to continue well into the future. To effectively utilize these forthcoming systems many of the algorithms used in current computational simulations will need to change. Our HO-LO approach, proven successful in CoCoMANS, shows promise for many related areas include nuclear weapons, fusion and fission energy, and climate/energy effects. The research results of this project prepare for a LANL leadership role in the DoE Exascale Initiative and can be applied effectively to urgent needs within the NNSA ASC program. By demonstrating a paradigm shift in our specific application areas, we have defined a computational co-design blueprint—the HO-LO algorithmic approach, high-performance software frameworks, and a pragmatic co-design process—that can be applied to other applications requiring fine-scale physics fidelity.

Publications

- Chen, , and Chacon. An analytical particle mover for the charge- and energy-conserving, nonlinearly implicit, electrostatic particle-in-cell algorithm. 2013. *JOURNAL OF COMPUTATIONAL PHYSICS*. 247: 79.
- Chen, , and Chacon. An energy- and charge-conserving, nonlinearly implicit, electromagnetic 1D-3V Vlasov-Darwin particle-in-cell algorithm. 2014. *COMPUTER PHYSICS COMMUNICATIONS*. 185 (10): 2391.
- Chen, G., L. Chacon, C. A. Leibs, D. A. Knoll, and W. Taitano. Fluid preconditioning for Newton-Krylov-based, fully implicit, electrostatic particle-in-cell simulations. 2014. *JOURNAL OF COMPUTATIONAL PHYSICS*. 258: 555.
- Knoll, D. A.. Computational co-design of multi-scale-applications in the natural sciences: CoCoMANS. 2013. LANL Computational physics and applied math external capability review.
- Knoll, D. A., L. Chacon, W. Daughton, and J. Payne. Plasma paradigm shift document for the CoCoMANS project. 2013. LA-UR-13-22126.
- Newman, , and D. A. Knoll. PHYSICS-BASED PRECONDITIONERS FOR OCEAN SIMULATION. 2013. *SIAM JOURNAL ON SCIENTIFIC COMPUTING*. 35 (5): S445.
- Payne, J., D. A. Knoll, A. McPherson, W. Taitano, L. Chacon, G. Chen, and S. Pakin. Computational co-design of a multiscale plasma application: a process and initial results. Presented at International Parallel and Distributed Processing Symposium. (Phoenix AZ, May 19-23, 2013).
- Taitano, W. T., D. A. Knoll, L. Chacon, J. M. Reisner, and A. K. Prinja. Moment-based Acceleration for Neutral Gas Kinetics with BGK Collision Operator. To appear in *Journal of Computational and Theoretical Transport*.
- Taitano, W. T., D. A. Knoll, L. Chacon, and G. Chen. DEVELOPMENT OF A CONSISTENT AND STABLE FULLY IMPLICIT MOMENT METHOD FOR VLASOV-AMPERE PARTICLE IN CELL (PIC) SYSTEM. 2013. *SIAM JOURNAL ON SCIENTIFIC COMPUTING*. 35 (5): S126.
- Taitano, W. T., D. A. Knoll, and L. Chacon. Charge-and-energy Conserving Moment-based accelerator for a Multi-species Vlasov-Fokker-Planck-Ampere System, Part II: Collisional Aspects. To appear in *Journal of Computational Physics*.
- Willert, , C. T. Kelley, D. A. Knoll, and Park. Scalable Hybrid Deterministic/Monte Carlo Neutronics Simulations in Two Space Dimensions. 2013. 2013 12TH INTERNATIONAL SYMPOSIUM ON DISTRIBUTED COMPUTING AND APPLICATIONS TO BUSINESS, ENGINEERING & SCIENCE (DCABES). : 7.
- Willert, , C. T. Kelley, D. A. Knoll, and Park. HYBRID DETERMINISTIC/MONTE CARLO NEUTRONICS. 2013. *SIAM JOURNAL ON SCIENTIFIC COMPUTING*. 35 (5): S62.
- Willert, J., C. T. Kelley, D. A. Knoll, H. Dong, M. Ravishankar, P. Sathre, M. Sullivan, and W. Taitano. Hybrid Deterministic/Monte Carlo Neutronics using GPU Accelerators. 2012. 2012 11TH INTERNATIONAL SYMPOSIUM ON DISTRIBUTED COMPUTING AND APPLICATIONS TO BUSINESS, ENGINEERING & SCIENCE (DCABES). : 43.
- Willert, J., C. T. Kelley, D. A. Knoll, and H. Park. A Hybrid Deterministic / Monte Carlo Method for Solving the k-Eigenvalue Problem with a Comparison to Analog Monte Carlo Solutions. To appear in *Journal of Computational and Theoretical Transport*.
- Willert, J., W. T. Taitano, and D. Knoll. Leveraging Anderson Acceleration for improved convergence of iterative solutions to transport systems. 2014. *JOURNAL OF COMPUTATIONAL PHYSICS*. 273: 278.

Hierarchical Sparse Models for Robust Analysis of Video Data

Steven P. Brumby
20120103DR

Abstract

Vision is one of the hardest and most intriguing problems in artificial intelligence and computer science. Advances in the field have hinged on three fundamental challenges: (1) how to create mathematical models of natural video sequences that can generate and interpret the visual scene; (2) how to learn image feature representations in such models across many spatial and temporal scales and for many object categories; and, (3) how to exploit the sheer size and richness of large-scale video datasets now becoming available. This LDRD project has successfully addressed these three problems and has created novel video analysis models and algorithms the speed of which surpasses human capabilities. Our project has brought together world-class researchers in statistical modeling, computer vision, and high performance computing and allowed us to make a breakthrough in the description and understanding of video datasets.

Background and Research Objectives

One of the great remaining scientific challenges is to understand the structure of the visual world. Such understanding requires developing both the theoretical framework and the practical learning algorithms needed to decompose natural video sequences into a finite set of objects, drawn from thousands of categories distributed over a wide range of spatial and temporal scales. The widespread availability of high-resolution video cameras, mass storage devices, and cluster-on-a-chip processors has enabled tremendous opportunities in computer vision research, providing datasets large and rich enough to develop new ideas for how to represent and understand natural scenes. A breakthrough in this field has the potential to impact many important tasks, from automating safety and security inspections in critical facilities (e.g., nuclear reactors, hospitals), to enabling more autonomous ground vehicles and persistent surveillance in urban settings.

Scientific Approach and Accomplishments

Over the last three years our team brought together world-class researchers in statistical modeling, computer vision, and high performance computing. We pursued new research directions for three complementary areas of information science and technology: (1) We developed semisupervised learning algorithms to build multi-category deep probabilistic networks and study the performance of these models and algorithms on real-world data-sets with application to object detection, classification, and change/anomaly detection; (2) We extended the theoretical framework of sparse representations and compressive sensing to learn hierarchical sparse representations that describe video data of natural scenes at many spatial/temporal scales and many levels of object complexity; and, (3) We exploited manycore CPU and massively parallel GPU (graphical processing unit) computing technology for efficient training and fast execution of our models and algorithms, and explore size, weight and power (SWaP) constraints on algorithm and software design for next-generation smart sensors.

We have integrated the advanced sparse representation algorithms (non-convex basis pursuit denoising algorithms) into the high performance codes, producing a new code we call VAST (Video Analysis and Search Technology). We were the highest-ranked Institutional Computing proposal for 2013, and were awarded 1.5M core-hours/years for 2013 and 2014. The team has produced a total of 27 publications.

The team has identified and collected a new partially-labeled video dataset to support our core research, the Twitter Vine social media video dataset of public data, currently being posted worldwide at a rate of ~1M videos/day. At the conclusion of this project we have over 1 petapixel of video from this source, which has generated significant interest amongst sponsors and visitors (to give a feel for the scale of this data base, printing every frame at a standard 300 dpi would cover 2 million

reams of paper, filling 15 semi truck trailers to their load limit). Social media video is an exciting new type of data, with many real-world applications ranging from epidemiology to facility security to intelligence, and the volume of social media video is expected to explode with the arrival of wearable networked video cameras (e.g., Google Glass). This data complements existing holdings of satellite imagery, aerial video, ground video, astronomical imagery, and social media (still) imagery that we continue to work on in new projects.

We worked with LANL Technology Transfer (TT) Division to support Intellectual Property (IP) protection and licensing of tools developed under the LDRD-DR. TT has contracted external counsel to support 3 patent filings based on our work. This year we organized and co-sponsored a Center for Nonlinear Studies workshop on Statistical Image Analysis in conjunction with our mid-project review. Feedback from our mid-project review was very encouraging. The capability we are developing under this LDRD-DR has brought in a number of DoD and USG Phase I demonstration projects and members of our team are supporting new projects won from DARPA (DARPA/MTO UPSIDE program) and NNSA+DTRA. We also started developing a collaboration with New York University (NYU) Polytechnic Center for Urban Science and Progress (CUSP), which grants us access to urban remote sensing video and social media datasets that directly support our core technical goals and position us for follow-on projects.

We also supported one of the student teams at LANL Engineering Institute's Dynamics Summer School, which provides us with the opportunity to work with video data collected by a small remotely-piloted helicopter. We demonstrated practical and theoretical advantages of learning reduced sets of highly discriminative features for classification data problems. Moreover we led an effort on Worldview-2 wide area multispectral imagery analysis and ground cover classification using sparse representations over machine learned dictionaries. We also developed and implemented methods of pre-conditioning training-data to learn multiscale vegetative, hydrologic, and geologic dictionaries of land cover features. Finally, we developed and implemented an image classification algorithm for astronomy imaging surveys from Palomar Transient Factory, improving the figure of merit by a factor of two. The Python code implementation has been running successfully at NERSC since July 2013.

In the last year of our project the main accomplishments were training the VAST code on various applied data sets for Work-for-Other sponsors. We were able to accelerate the training process using a clever math trick, which resulted in a patent application. We applied sparse methods

to Palomar Transient data and halved their false alarm rate for the same detection rate for optical transients. That code is now running nightly at the Palomar Observatory. We created a graphical user interface (GUI) tool to run VAST that allowed exploration of social media data including Twitter Vine videos. We demonstrated how to run our code in virtual machines and used the Amazon cloud to host our GUI demo and process/classify videos with multiple object categories. Finally, a spinoff company was created to commercialize the VAST video analytics code base.

Impact on National Missions

The theoretical framework, algorithms and codes developed in this project have provided a solid basis for new information science and technology capability to support several of LANL's core mission areas. Robust, fast, automated understanding of video has the potential to revolutionize analysis of large-scale video data of experiments and simulations, global-scale environmental science, proliferation detection, and safety and security applications (perimeter security, workplace safety monitoring, remote hazardous inspections). This capability has also significantly impacted DOE/NNSA and our other US government partners by enabling: autonomous vehicles using passive video sensors, automated threat detection, forensic imagery and video analysis tools, persistent surveillance video tools for warfighter support, forest fire monitoring, border security, remote inspections of infrastructure, disaster response, and robotic space exploration. We presented our results at leading conferences, published in high impact scientific journals, and successfully developed projects with external sponsors.

Publications

- Bachega, L., J. Theiler, and C. Bouman. Evaluating and improving local hyperspectral anomaly detectors. 2011. In 2011 IEEE Applied Imagery Pattern Recognition Workshop: Imaging for Decision Making, AIPR 2011 ; 20111011 - 20111013 ; Washington, DC, United States. , p. var.pagings.
- Brumby, S.. Image fusion for remote sensing using fast, large-scale neuroscience models. 2011. In Multisensor, Multisource Information Fusion: Architectures, Algorithms, and Applications 2011 ; 27-28 April 2011 ; Orlando, FL, USA. Vol. 8064, p. 806402 (8 pp.).
- Brumby, S. P., M. I. Ham, and G. T. Kenyon. Semi-supervised learning of high-level representations of natural video sequences. Presented at Computational and Systems Neuroscience (COSYNE) . (Salt Lake City, UT, 23-26 Feb 2012).
- Chartrand, R.. Nonconvex Splitting for Regularized Low-

- Rank plus Sparse Decomposition. Invited presentation at Joint Mathematics Meetings. (Boston, MA, 4-7 Jan. 2012).
- Chartrand, R.. Nonconvex Splitting for Regularized Low-Rank + Sparse Decomposition. Invited presentation at Compressive Sensing Workshop: Leveraging Sparsity at UCLA & Beyond. (Los Angeles, CA, 6-8 March 2012).
- Chartrand, R., and B. Wohlberg. A nonconvex ADMM algorithm for group sparsity with sparse groups . 2013. In IEEE International Conference on Acoustics, Speech, and Signal Processing . (Vancouver, BC, 26-31 May 2013). , p. ?. Vancouver: IEEE.
- Chartrand, null.. Image processing and reconstruction. 2012. LDRD.
- Galbraith, A. E., R. Chartrand, B. Wohlberg, and S. P. Brumby. Simulating vision through time: Hierarchical, sparse models of visual cortex for motion imagery. 2012. In IEEE Applied Imagery and Pattern Recognition (AIPR) 2012. (Washington, DC, 23-25 Oct, 2012). , p. 1. Washington, DC: IEEE.
- Gunawardena, N., J. Heit, G. Lederman, A. Galbraith, D. Mascarenas, and S. P. Brumby. Remote placement of magnetically coupled ultrasonic sensors for structural health monitoring . Invited presentation at International Modal Analysis Conference. (Orlando, FL, 3-6 February, 2014).
- Huang, W., Z. Ji, S. Brumby, G. Kenyon, and L. A. Bettencourt. Development of invariant feature maps via a computational model of simple and complex cells. 2012. In 2012 Annual International Joint Conference on Neural Networks, IJCNN 2012, Part of the 2012 IEEE World Congress on Computational Intelligence, WCCI 2012 ; 20120610 - 20120615 ; Brisbane, QLD, Australia. , p. var.pagings.
- Ji, Z., J. Theiler, R. Chartrand, G. Kenyon, and S. P. Brumby. SIFT-based sparse coding for large-scale visual recognition. 2013. In SPIE Defense, Security, and Sensing. (Baltimore, MD, 29 April- 3 May 2013). , p. 87500K. Baltimore: SPIE.
- Ji, Z., W. Huang, and S. Brumby. Learning sparse representation via a nonlinear shrinkage encoder and a linear sparse decoder. 2012. In 2012 Annual International Joint Conference on Neural Networks, IJCNN 2012, Part of the 2012 IEEE World Congress on Computational Intelligence, WCCI 2012 ; 20120610 - 20120615 ; Brisbane, QLD, Australia. , p. var.pagings.
- Ji, Z., and S. P. Brumby. Integrating Bottom-up and Top-down Visual Attention for Object Segmentation. Presented at Vision Sciences Society (VSS) 2012 Annual Meeting. (Naples, FL, 11-16 May 2012).
- Moody, D. I., S. P. Brumby, J. C. Rowland, and C. Gangodagamage. Learning sparse discriminative representations for land cover classification in the Arctic. 2012. In SPIE Optics + Photonics Annual Meeting 2012. (San Diego, CA, 11-16 Aug. 2012). , p. 85140Q. San Diego: SPIE.
- Moody, D., S. Brumby, K. Myers, and N. Pawley. Sparse classification of rf transients using chirplets and learned dictionaries. 2011. In 45th Asilomar Conference on Signals, Systems and Computers, ASILOMAR 2011 ; 20111106 - 20111109 ; Pacific Grove, CA, United States. , p. 1888.
- Paiton, D. M., S. P. Brumby, G. T. Kenyon, G. J. Kunde, K. D. Peterson, M. I. Ham, P. F. Schultz, and J. S. George. Combining Multiple Visual Processing Streams for Locating and Classifying Objects. Presented at IEEE Southwest Symposium on Image Analysis and Interpretation (SSIAI) 2012. (Santa Fe, NM, April 22-24, 2012).
- Rodriguez, P., and B. Wohlberg. Iteratively Reweighted Least Squares for L1 Problems: Boring But Still Effective. Presented at 2012 SIAM Conference on Imaging Science. (Philadelphia, PA, May 20-22 2012).
- Rodriguez, P., and B. Wohlberg. Fast principal component pursuit via alternating minimization . Invited presentation at IEEE International Conference on Image Processing . (Melbourne, AU, 15-18 Sept, 2013).
- Rodriguez, P., and B. Wohlberg. A comparison of the computational performance of iteratively reweighted least squares and alternating minimization algorithms for l1 inverse problems . 2012. In IEEE International Conference on Image Processing. (Orlando, FL, 30 Sept- 3 Oct, 2012). , p. 3069. Orlando: IEEE.
- Theiler, J., B. Wohlberg, and R. Chartrand. Local Robust Principal Components for Nonlinear Datasets,. Presented at 2012 SIAM Conference on Imaging Science. (Philadelphia, PA, May 20-22 2012).
- Theiler, J., G. Cao, L. Bachega, and C. Bouman. Sparse Matrix Transform for Hyperspectral Image Processing. 2011. IEEE JOURNAL OF SELECTED TOPICS IN SIGNAL PROCESSING. 5 (3): 424.
- Theiler, J., and B. Wohlberg. Detection of spectrally sparse anomalies in hyperspectral imagery. 2012. In 2012 IEEE Southwest Symposium on Image Analysis and Interpretation, SSIAI 2012 ; 20120422 - 20120424 ; Santa Fe, NM, United States. , p. 117.
- Theiler, J., and B. Wohlberg. Regression framework for background estimation in remote sensing imagery. 2013. In Institute of Electrical and Electronics Engineers (IEEE) Workshop on Hyperspectral Image and Signal Processing: Evolution in Remote Sensing

(WHISPERS) . (Gainesville, FL, 25-28 June 2013). , p. 1.
Gainesville: IEEE.

Theiler, J., and B. Wohlberg. Detection of unknown gas-phase chemical plumes in hyperspectral imagery. 2013. In SPIE Defense, Security, and Sensing. (Baltimore, MD, 29 April- 3 May 2013). , p. 874315. Baltimore: SPIE.

Venkatakrishnan, S. V., C. A. Bouman, and B. Wohlberg. Plug-and-play priors for model based reconstruction. 2013. Purdue University, ECE Technical Reports.

Venkatakrishnan, S. V., C. A. Bouman, and B. Wohlberg. Plug-and-play priors for model based reconstruction. 2013. In IEEE Global Conference on Signal and Information Processing . (Austin, TX, 3-5 Dec. 2013). , p. 1. Austin, TX: IEEE.

Wohlberg, B.. Inpainting by Joint Optimization of Linear Combinations of Exemplars. 2011. IEEE Signal Processing Letters. 18 (1): 75.

Wohlberg, B., R. Chartrand, and J. Theiler. A Robust Local Linear Data Decomposition. Presented at Learning Workshop. (Snowbird, UT, April 3-6, 2012).

Wohlberg, B., R. Chartrand, and J. Theiler. Local Principal Component Pursuit for Nonlinear Datasets. Presented at IEEE International Conference on Acoustics, Speech, and Signal Processing (ICASSP) (2012). (Kyoto, Japan, March 25-30, 2012).

Enabling Data-aware Distributed Scientific Computing

Tanmoy Bhattacharya
20140090DR

Abstract

Multiple domains of scientific studies are facing problems with the analysis of large amounts of diverse distributed fast-accumulating data [1]. Fundamentally, there are four challenges [2] that need to be overcome. The first is the problem of assembly: each elementary step in the solution now depends not only on many more data items, but also needs to reconstruct the result from highly fragmented and distributed data. Second, contrary to the standard model of a database that absorbs data infrequently and formats them to be able to answer multiple queries regarding the existing collection, today most disciplines gather data faster than the questions change. Third, a typical question now depends on correlating various kinds of data streams that do not have an intrinsic feature that can register the items in the various streams with respect to each other. And, finally, much of the large data can only be curated statistically, and the analysis methods need to be robust against errors in any single piece of data. This project demonstrates a few commonalities between the challenges faced by these diverse domains, and finds common methods to solve them. In particular, it develops a method for expressing the typical scientific computation that works on many exchangeable items of data in terms of a programming paradigm that is slightly more general than the Map-Reduce architecture developed by Google [3], and implementable on a wide variety of machines connected by the internet. It also shows that one of the most efficient means of using data to obtain information about scientific theories, called the Maximum Likelihood (ML) approach, can be carried out as a streaming update or estimation from distributed data without expensive collocation. Both of these developments can be used in aid of virtually all scientific fields that use big data in their inference.

Background and Research Objectives

We are fast entering the age of big data: the cost of generating data is fast shrinking, but the cost of stor-

ing, moving, and analyzing such data is ever growing. In addition, uncontrolled collection, use, and collocation of big data lead to serious privacy concerns. Nevertheless, the payoff in using such data is large, and controlling the problems is essential if we are to answer the next generation of scientific challenges. This is most obvious in the problems dealing with surveillance and situational awareness, where large quantities of diverse distributed data need to be correlated to effect early detection of problematic anomalies. But, the same problems arise in deeply theoretical scientific domains where rich models of reality need to be parameterized by equally vast amounts of observations and constrained by correlating many kinds of data. Thus, for example, the idea that we might, some day, be able to understand the entire metabolome of a simple organism, or the entire connectome of the human brain would remain a fantasy if we are unable to harness the power of big data.

In many of the scientific disciplines facing this problem, the issue is not to generate the data. Fast techniques exist today for extracting the relevant information from our physical world. It is rather the cost of validating and cleaning such data, of moving them to a central location, of assembling various fragments into meaningful units, and of using them to parameterize scientific models that is becoming prohibitive. Currently, every scientific discipline that is facing this issue is using expert knowledge and worker experience to find pragmatic solutions that work in that particular field. In this fashion, commonalities due to the underlying integrated nature of the problem that can be exposed by a mathematical and computer science approach to this problem remain unexploited.

On the other hand, the use of big data in the scientific domains is markedly different from those in information query. When one searches over a large database, one is essentially asking questions about correlations between various search terms. Even the scoring systems that

characterize the importance of a result are often represented as a quantity diffusing over the network of connections between the items of data. All of these are inherently linear estimation situations on data of homogeneous and flat structure. Scientific data, by contrast, are often hierarchical, of diverse nature, and used to fit extremely nonlinear models.

The problem of parameter estimation is well studied and the kind and amount of data needed are often well understood by the domain experts. The problem remains that the algorithms for such estimation are often stated for data that is co-located. Applied to distributed data, these algorithms suffer from large amounts of expensive data movement. In this project, we therefore studied two aspects of this general problem: first, we developed a method for carrying out ML estimation in a streaming or distributed fashion, and second, we developed a general method for programming using distributed data stores. We then applied these developments to aspects of bio-surveillance.

Scientific Approach and Accomplishments

Maximum Likelihood Estimators are asymptotically unbiased, consistent, and efficient; so they are the method of choice for estimating parameters for scientific models. Sometimes their estimation is expressed as the simple arithmetic average of a function evaluated on individual pieces of input data. When this is the case, it is easy to apply it to both streaming and distributed data: essentially, this follows from the fact that the average of data relegated to distinct stores is a simple weighted average of the averages of the data stored in each. This simple picture breaks down when the ML estimator is not a simple average.

Nevertheless, in many cases, the ML estimator can be rewritten as a function of a small number of quantities, each of which is an average. In these cases, the problem of ML estimation can be simplified by maintaining a reduced state consisting of these averages, and calculating the final estimate from this state. The state is a small amount of data that can be continuously updated and passed around. Nick Hengartner and colleagues developed this method into a systematic procedure. The fundamental idea in the method is to develop an approximation for the ML estimator in terms of the Taylor expansion of the log-Likelihood function. An example of sequential estimation of the parameter of a truncated Poisson distribution is shown in Figure 1. The parameter estimation fluctuates initially, but, as is expected, the ML estimator stabilizes and approaches the correct value as the data stream from which it is extracted gets larger.

Such problems of estimation of Poisson parameters are

very common in surveillance domains where the fundamental problem can often be expressed as the detection of anomalous rates of events. The theoretical model sets the expectation of what a problematic anomaly looks like: thus, for example, a cyber attack usually involves connected sets of anomalous connections, rather than random anomalies across the network. One, therefore, builds models of rates of normal traffic on individual links and on connected sub-graphs, usually modeled as a time-varying Poisson process. As part of our project we investigated the efficacy of updating the model in a streaming fashion rather than re-estimate starting from the entire data store.

Though in a different problem domain, a similar problem arises in bio-surveillance. Isolated instances of diseases are less of a public health threat than epidemics spreading along the contact routes. Again, the primary quantity that needs to be estimated is a rate of infection along each contact link, where the problem is, however, complicated by heterogeneity and comorbidities. We investigated the nature of available data and how they may best be used to estimate R_0 , the basic infection rate, and how to update the estimate as new data comes in.

Equally important as the statistical problem, however, is the issue of being able to program a distributed data store. Problems in which one needs to average some quantity, and, by the results stated above, these are aplenty, rely on a very homogeneous view of the data store. The general operation in which a hierarchical data structure can be reduced to a single state in a parallel way is the central operation in many functional languages: in particular, it is often called a fold or a reduce operation. The other basic piece that is needed to build up the general computation is of course the map operation that can work on isolated pieces of data and apply a function to them. Using these building blocks, Google implemented a general programming model called Map-Reduce that alternately applies a Map operation, followed by sorting and collecting the data items, and then applying reduce operation to the subsets of the data.

The standard implementation of Map-Reduce, however, requires a specialized architecture called Hadoop that automatically implements the intermediate sort, and provides redundancies and fault-tolerance that are essential for big-data computing. Our investigators Mike Fisk and Curt Hash presented a new idea [4] that extends this in three ways. First, they isolated the core calculational units from the input-output routines so that the 'machine' can be used with user-defined, possibly hierarchical, data formats rather than flat key-value stores. Second, they allowed an implementation on commodity machines on the Internet without needing superuser privileges. Finally, they allowed

additional operations that can bypass the expensive sorting operations when those are unneeded and can allow expression reuse. The resulting implementation called Filemap was then tested and, as shown in Figure 2, found to outperform Hadoop implementations most of the time.

Impact on National Missions

Big data is of central importance to a number of problems of national interest. In particular, situational awareness and ubiquitous surveillance needs us to be able to analyze large stores of distributed data without co-locating them, co-location is both expensive and raises serious privacy concerns. This project, though directly affecting cybersecurity and bio-surveillance has the potential to affect many other projects such as activity-based intelligence for nuclear non-proliferation.

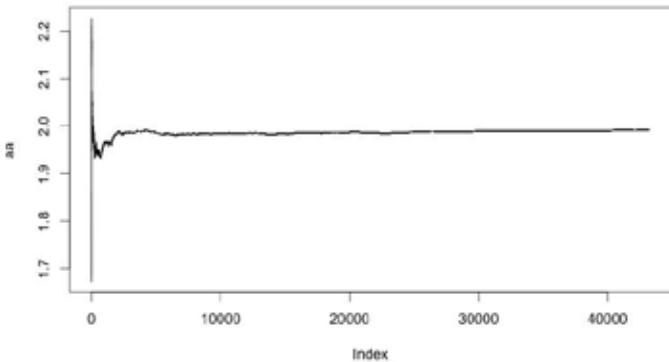

Figure 1. Sequential estimation of the parameter of a truncated Poisson distribution. The true value of the parameter is 2, and only nonzero sample values are available. The estimator asymptotically reaches the true value and the fluctuations diminish with time.

Platform	Baseline	Time	Filemap	Speedup
Laptop	Serial	315.7s	410.6s	0.8x
Laptop (compressed)	Serial	227.4s	378.5x	0.6x
SMP	Serial	246.3s	236.4s	1x
SMP (compressed)	Serial	236.4s	24.3s	10x
Cluster	Hadoop	104.0s	52.5s	2x
Cloud	Get+SMP	403.2s	29.3s	14x
Cloud (compressed)	Get+SMP	348.9s	35.4s	10x

Figure 2. Comparison of Filemap with previous implementation in a simple task on various platforms. Except on a laptop where its overhead of setting up the parallel structure compared to a straight serial implementation is not compensated, it beats the competing implementations by factors of up to 14.

References

1. Dean, J., and S. Ghemawat.
2. Jordan, M.. Frontiers in massive data analysis. 2013. Report by the National Research Council of the National Academies.
3. The four V’s of big data. The Big Data and Analytics Hub.
4. Fisk, M. E., and M. Jordan. FileMap: map-reduce program execution on loosely-coupled distributed systems. 2014. In Fourth International Workshop on Cloud Data and Platforms. (Amsterdam, the Netherlands, 13 Apr. 2014). , p. Article 6. New York, New York, USA: Association of Computing Machinery.

Publications

- Fisk, M. E., and C. L. Hash. FileMap: map-reduce program execution on loosely-coupled distributed systems. 2014. In Fourth International Workshop on Cloud Data and Platforms. (Amsterdam, the Netherlands, 13 Apr. 2014). , p. Article 6. New York, New York, USA: Association of Computing Machinery.

Quantum Methods for Fast Signal Processing and Metrology

Rolando D. Somma
20130741ECR

Introduction

The project aims at developing novel quantum methods or transformations for fast signal processing. A generalization of the well-known Fourier transform (FT) to design transformations that could be implemented on a quantum processor with dramatic speedups is of interest. The quantum method will be applied to problems in signal analysis and quantum metrology.

In particular, the project focuses on developing a quantum variant of the so-called fractional Fourier Transform (frFT) suitable for exponentially fast implementation. In signal analysis, the frFT is more powerful than the FT because it allows to eliminate unwanted noise in more general scenarios. For a sample of size N , a quantum frFT that could be implemented using logarithmic in N or $\log(N)$ operations on a quantum-information processor is ideal. (The same transformation takes more than $N \gg \log(N)$ operations on a conventional computer.) The quantum frFT will be used to build methods for radar analysis and image processing that are exponentially faster than conventional ones. The potential of such transformation for quantum metrology (high-precision sensing) and related quantum algorithms will also be studied.

For risk mitigation, the project includes two complementary approaches to find the transformation. Even if an exponential speedup for the frFT implementation cannot be formally proved, polynomial speedups are already a major advance towards proving the power of quantum information in signal analysis.

Benefit to National Security Missions

This is a novel approach in quantum science with interdisciplinary impact that will generate new interdisciplinary collaborations. This research is a direct response to the FY13/FY14 IS&T Grand Challenge on quantum information science. The project also enhances

other capabilities at Los Alamos, including sensing, metrology, and quantum cryptography.

Previous LANL research on quantum information led the PI to start new collaborations with Sandia National Labs on building a small-scale quantum computer, to obtain an NSF grant bringing summer students to LANL, and to obtain an AFOSR grant in collaboration with the University of Pittsburgh. The current project will enhance LANL's capabilities in the quantum arena for a sustainable future, allowing the ECR investigator to start a program in quantum methods to solve important science problems of mission relevance.

Progress

We have followed a physical approach to develop a quantum transformation that is a good approximation to the desired quantum fractional Fourier transform. The approximation error decreases very fast (exponentially fast) with the dimension of the space of the problem, making it an excellent candidate for applications. Remarkably, the implementation cost of our approximate quantum fractional Fourier transform is significantly smaller (almost exponentially smaller) than the implementation cost of the corresponding conventional fractional Fourier transform. Thus, the first milestone of this project has been achieved on schedule. Our results have been presented in conferences and we are in the process of submitting a manuscript.

Future Work

The main task for FY15 is applying the developed quantum fractional Fourier transform (frFT), or an approximate version. Of special interest are problems in simulation of continuous-variable quantum mechanics and problems in signal analysis. In all these cases, we expect our transformation to provide major algorithmic quantum speedups with respect to the conventional algorithms for these problems.

Conclusion

If successful, our proposal on building a quantum frFT will bring an entirely new tool for signal processing and related quantum-information tasks, with dramatic speedups over conventional methods for those problems. Based on preliminary results, we expect to find a quantum frFT with desired properties in the near future. Potential complications may arise when looking for an efficient implementation on a quantum processor. We will hedge against these complications by attacking this problem with two different approaches. Moreover, if necessary, we can avoid excessive overhead in the implementation by building approximate transformations instead.

Stochastic Modeling of Phase Transitions in Strongly Interacting Quantum Systems

Christopher Ticknor
20130749ECR

Introduction

This research explores thermal phase transitions in quantum systems. Two sets of codes will be developed, the first is a static, perturbative treatment. This will extend a standard treatment for quantum gases at finite temperature to study multicomponent, dipolar quantum gases. The second set of codes, is a stochastic method, this theory will more fully account for the fluctuating nature of quantum systems. Both codes will be used to study intriguing quantum behavior near thermal phase transitions. Completely developing the SPGP method in 2 years will be a challenge - there are many technical challenges to be met. These codes will tackle an interesting problem: thermal phase transitions. Understanding such complex systems is a significant challenge, with substantial payoff.

Benefit to National Security Missions

The numerical methods studied here are an important step in developing hybrid quantum/classical codes that can treat fundamental quantum behavior in high temperature regimes. Solving a full quantum treatment at high temperatures is simply not possible, and therefore an alternate method needs to be developed which retains aspects of quantum behavior. That is exactly what this work does.

This work additionally looks at phase transitions of quantum systems. This will help understand the behavior of finite quantum systems beyond ideal settings and conditions.

Progress

This year we have made good progress on developing the tools need to study multi-component gases.

Russell, the postdoc, and I are working well together and doing separate, but related projects and learning from each other well. We are sorting through a large amount

of data and preparing a few papers.

We each have working bogoliubov codes for the multi-component gases and we are analyzing them in a distinct manner to more quickly develop our understanding of them.

Russell has developed the desired codes (SPGP) and will soon run them to the dipolar system.

Future Work

In the next year, I will fully develop a perturbative and static treatment known as Hartree-Fock Bogoliubov Popov (HFBP). With this code, I will study the thermal phase transition of a two component immiscible, dipolar quantum gas.

Next, I will start the development of a dynamic method known as the Projected Gross Pitaevskii (PGP) method. This method will study two thermal phase transitions: the miscible/immiscible character of the quantum gas and the phase coherence as temperatures is changed. This method will be able to go to the strongly interacting regime, unlike the first method (HFBP).

Conclusion

The goal of this project is twofold: first, develop two flavors of codes to study finite temperature quantum gases. Second, study thermal phase transitions of quantum gases. It is unknown how temperature alters the miscible/immiscible character of ultracold quantum gases. Additionally, study the thermal phase transitions which dictates the coherence of the quantum gas. This work will influence how experiments are run and how finite quantum systems are understood.

Publications

Ticknor, C.. Excitations of a trapped two-component Bose-Einstein condensate. 2013. PHYSICAL REVIEW

A. 88 (1): 013623.

Ticknor, C.. Dispersion relation and excitation character of a two-component Bose-Einstein condensate. 2014. PHYSICAL REVIEW A. 89: 053601.

Ticknor, C., R. Bisset, and R. M. Wilson. Quantum criticality in a trapped binary Bose gas. Submitted to PRL, arxiv.org/1409.6074.

Ticknor, C., and R. Bisset. Finite-resolution fluctuation measurements of a trapped Bose-Einstein condensate. 2013. PHYSICAL REVIEW A. 88: 063624.

Deterministically Enhanced Monte Carlo for Radiative Transfer

Allan B. Wollaber
20120738ECR

Abstract

“Hot” problems (supernovae, inertial confinement fusion, oxy-coal combustion) can require an accurate simulation of radiative heat transfer, but modeling the nonlinear exchange of energy between moving matter and photon radiation is a considerable algorithmic and computational challenge. The Implicit Monte Carlo (IMC) method has emerged as the preferred approach for high-fidelity radiation simulations, but its underlying equations can produce nonphysical solutions for large time steps, and its stochastic implementation leads to statistical noise, particularly in “cold” problem regions. We propose a novel way to use a low-order linear algebra (deterministic) calculation to simultaneously (1) enhance the temporal accuracy of the IMC solution, (2) reduce its statistical uncertainty, and (3) accelerate the overall calculation. Specifically, averaged interaction coefficients are generated during the high order calculation and provided to a dimensionally reduced deterministic solver that then calculates an estimate of the upcoming radiation and material temperature solutions. The approximate material temperature is then exploited to provide time-centered (instead of time-explicit) interaction coefficients and a physics-based time-step controller for the upcoming IMC cycle. The approximate radiation temperature is utilized to reduce the statistical uncertainty in the IMC solution, to reduce the time to solution, and to identify important problem regions to further accelerate the calculation. Thus primed, the IMC calculation is carried out and supersedes the approximate solution. We deployed this approach in production software and demonstrated accuracy improvements and reduced variance.

Background and Research Objectives

The Implicit Monte Carlo (IMC) method, first published in 1971, provides a means of solving the nonlinear thermal radiative transfer (TRT) equations, which describe the time-dependent interaction of radiation and matter [1]. Because the material temperature and radiation are

strongly dependent on each other (nonlinear), the IMC method solves the time-dependent problem one time-step at a time by assuming some of the temperature-dependent data can be “frozen” at the beginning of a time-step. This is accurate so long as the time-steps are not too large and the temperature does not change too much, but this is difficult to ascertain before examining the solution, and the solutions are expensive enough with respect to computer resources that they are not typically repeated. Additionally, as the name implies, IMC solutions are typically generated using Monte Carlo methods in which “particles” are computer-simulated by randomly generating them from thermal sources, allowing them to probabilistically scatter and/or absorb throughout the matter, and then tracking them until they either leave the system or survive into the next time step. In the limit of an infinite number of particles, the solution that the particles trace out is the exact solution of the IMC equations, but, with finite resources, this solution always contains some stochastic “noise”, or statistical variance. There are ways of reducing this variance by changing the way the particles are tracked to preserve the average solutions, but current software uses relatively simple techniques that can result in high variance even at high particle counts.

The objectives of this research were to provide a means to inexpensively guess the shape of the solution at the end of an upcoming solution in order to increase and/or control the accuracy of the IMC solution and to reduce the statistical variance in the IMC solution. This is accomplished by creating a new, low-order system of equations with many fewer unknowns than the IMC equations that can be solved deterministically (using linear algebra instead of Monte Carlo) before each IMC cycle. The data needed by the deterministic solution is constructed using information gathered from the previous IMC time step. The deterministic temperature solution can then be used to generate time-centered, temperature-dependent data, which is more accurate

than the beginning-of-time-step data, and the radiation solution can be used to reduce solution variance throughout the problem using a technique known as weight windows. When this research began, this had never been done using production software; it had only been demonstrated in an academic setting [2]. Techniques that couple Monte Carlo and deterministic solution methods are referred to as hybrid methods.

Scientific Approach and Accomplishments

At this project's outset, the preliminary hybrid method employed a low-order system that is difficult to extend to multidimensional problems. The low-order system also required several approximations that are known to be inaccurate for free-streaming radiation. Therefore, we derived a new low-order system of equations that is more extensible to multidimensions and used fewer approximations [3]. We then implemented the required tally information into Jayenne software, which is production software for solving the IMC equations. We also created a new software package, Asterisk that coupled Jayenne software to Capsaicin software, which is a production deterministic software package. Throughout the project, software verification and regression tests were developed and exercised daily using modern project management software (subversion, Redmine, and CDash). Having done this, we demonstrated the accuracy of the approach in the premier conference for this field [3].

We then recruited a summer student, Alex Long, to assist in the development of weight windows for variance reduction. In Jayenne and other Monte Carlo software packages, particles are often assigned a particle weight that is allowed to vary as the particle is tracked. The magnitude of the particle's weight is proportional to its effect on its contribution to the solution estimates. Previously, there was no means of controlling the minimum and maximum weights of IMC particles in Jayenne software. Weight windows controls the maximum particle weight in a region by splitting a single, heavyweight particle into multiple, lightweight particles. In order to conserve energy in our version, the minimum particle weight is controlled by making it more likely for the lightweight particles to be absorbed. The center of the weight window is set using the expected radiation intensity computed by the low-order deterministic method from the previous time step, which, according to theory, produces nearly uniform Monte Carlo densities and statistics. By the end of the summer, Alex implemented a new version of weight windows into Jayenne software and demonstrated its effectiveness through Asterisk in a staff activity seminar, thereby providing a first-of-a-kind capability in production IMC software. Since that time, coupled problems using both the temperature prediction

and the weight window have since been demonstrated, although there is more work to be done in order to make the process more robust.

Fortunately, this project was appraised highly and was also selected for transition to programmatic funding near its conclusion. In particular, further studies may now continue to build on this work by expanding allowable spatial mesh types, analyzing any limitations in the low-order discretization, and considering alternative weight-window centerings, in particular, using some of the recent adjacent work that has been proven very successful in global, steady-state problems.

Impact on National Missions

Because this project was demonstrated by coupling existing and creating new production software, it is straightforward to continue the path to deployment in laboratory software used to model high energy density physics (HEDP) experiments, including inertial confinement fusion (ICF) problems. These problems can require very large particle counts and time-consuming user trial and error to prevent statistical noise from seeding instabilities into their hydrodynamic evolution. Using automatic variance reduction, as described in this work, ameliorates the adverse effects of statistical noise on the overall solution in a user-friendly way.

Additionally, because hybrid deterministic-Monte Carlo methods constitute cutting-edge research in this field, research progress and visibility in this area already has and will continue to attract top graduate students to work at LANL.

References

1. Fleck, J. A., and J. D. Cummings. An implicit Monte Carlo scheme for calculating time and frequency dependent nonlinear radiation transport. 1971. *Journal of Computational Physics*. 8: 313.
2. Wollaber, A. B.. Advanced Monte Carlo methods for thermal radiation transport. 2008. PhD thesis, The University of Michigan.
3. Wollaber, A. B., and J. S. Warsa. A new, coupled transport-diffusion method for radiative transfer calculations. 2013. In *Proc. ANS Topical Meeting, International Topical Meeting on Mathematics and Computation, American Nuclear Society*. (Sun Valley, ID, 5-9 May 2013). , p. 7293. Sun Valley, ID: American Nuclear Society.

Publications

Wollaber, A. B., and J. S. Warsa. A New, Coupled Transport-Diffusion Method for Radiative Transfer Calculations. 2013. In International Conference on Mathematics and Computational Methods Applied to Nuclear Science and Engineering (M&C 2013). (Sun Valley, ID, 5-9 May 2013). , p. 7293. La Grange Park, IL: American Nuclear Society.

A Computationally Efficient Model for Warm Dense Mixtures

Didier Saumon
20130244ER

Introduction

This research will create the theoretical and computational framework to model mixtures of two (or more) materials in the “warm dense matter” regime. This will be a new, state-of-the-art capability to model extreme states of matter that will support future experiments at high-energy-density-physics facilities (e.g., the National Ignition Facility) and numerous fundamental and programmatic applications involving the hydrodynamics of dense plasma mixtures.

Warm dense matter (WDM) conditions typically occur at temperatures of 5000 to 10,000,000 degrees and densities from a tenth to fifty times normal solid densities. WDM is too hot to be treated by the standard methods of condensed-matter and liquid-state physics, but too cool to be modeled as a weakly coupled plasma; it is too dense to be treated as an ionized gas, but not dense enough to approach simplifying asymptotic limits. It lies in an intermediate region where all the physics matters and simplifying approximations are elusive. It is a frontier of high energy density physics of great practical importance.

WDM mixtures lie at the heart of unsolved problems in planetary science and stellar astrophysics. Examples include the phase behavior of hydrogen and helium in Jupiter and Saturn and gravitational stratification of elements in white dwarf stars. WDM mixtures also occur during the implosion phase of inertial confinement fusion capsules and in nuclear explosions.

Our proposed work lies at the forefront of this exciting and rapidly growing field. While large-scale simulations, such as quantum molecular dynamics, are currently the favored approach to study WDM, they are computationally very expensive – requiring hundreds or thousands of computing hours for a single result. By contrast, our model, based on a modern variant of the “quantum hypernetted chain” theory, holds the promise of being a

hundred to a thousand times faster, comparably accurate, and tractable for mixtures.

Benefit to National Security Missions

NASA

The primary applications thrust of our research is astrophysical – with an initial focus on examining hydrogen and helium phase behavior in Jupiter and Saturn, and understanding heavy-element diffusion in DZ white dwarf stars. In a broader sense, this research will create a robust capability for scientists to develop accurate equations of state and transport coefficients for wide varieties of astrophysical phenomena.

Understanding of Materials

Warm dense matter is a frontier of materials physics. Because it describes a region of temperature and density space devoid of simplifying approximations, all of the physics matters. It is also a region difficult to probe experimentally. The capability to model mixtures in this regime will advance our basic knowledge of materials behavior in extremes.

MaRIE

One of the objectives of MaRIE is to probe experimentally the same regions of temperature and density that we are describing theoretically, so the two programs are complementary. Our theoretical model could be used to design and guide MaRIE experiments, and the experimental results could be used to validate and improve our model.

NNSA/DP and Nuclear Weapons Programs

During a nuclear explosion, and in inertial confinement fusion, mixtures of warm dense matter can be created. This research potentially enhances our capability of modeling materials as they pass through this regime.

NNSA/Non-proliferation

The ability to make accurate equations of state for a wide variety of warm, dense, mixed materials lends itself to better anticipating and ameliorating the effects of rogue WMDs.

Progress

Validation of the model for warm dense matter (WDM) mixtures

The primary means of validation of the model is by comparison with simulations that involve fewer approximations but that are computationally much more expensive. These fall into two broad categories, the so-called Quantum Molecular Dynamics (QMD) and the Thomas-Fermi Molecular Dynamics (TF-MD). The latter is more economical of computer time and is appropriate at high temperatures and high densities where quantum effects become less important. We have compared our ionic pair distribution functions with simulations for several systems: 1) published TF-MD mixture of copper and deuterium with excellent agreement, 2) QMD simulations of a carbon-hydrogen mixture over a wide range of temperatures and densities. Here we found excellent agreement at high density and temperature and very poor in the limit of low density and temperature. Further investigation showed that chemical bonds form between carbon atoms in the low-temperature mixture, a phenomenon not accounted for in our model. A comparison with our own TF-MD simulations of the same mixture, in which bonding cannot occur, shows much better agreement. 3) finally, a first test for a carbon-oxygen mixture (relevant to our applications to white dwarf stars) with our TF-MD simulation shows excellent agreement. In summary, our mixture model is quite reliable for the prediction of the structure of the plasma for temperatures above 10000K and densities above that of the solid. Certain elements (such as carbon) can form strong chemical bonds that persist in the WDM regime, in which case our model is no longer applicable.

Diffusion coefficients

The calculation of ionic inter-diffusion coefficients applicable to white dwarf stars is one of the major applications of our mixture model. The diffusion coefficient is a dynamic property of the plasma related to the motion of ions but our mixture model is a purely static model. We devised an approach by combining the output of our static model with the dynamics modeled in a classical molecular dynamics simulation to obtain the diffusion coefficient. As both our model and this approach are fairly new, we have spent considerable effort to validate it by comparison with the diffusion coefficients obtained directly from our TF-MD simulations for several one-component systems. We have compared with published calculations for boron, copper,

deuterium and iron, and with our own extensive simulations for aluminum. In all cases, we have found excellent agreement, usually at the level of a few percent and never worse than 10%. This is within the accuracy of state-of-the-art simulations and is quite remarkable. This validates our model and our approach and we can now proceed confidently to mixtures. Our first calculation for a mixture (carbon-helium) shows agreement to better than 3%. We have started the validation for the carbon-helium mixture over a wider range of density and temperature prior to calculating an actual table for applications to white dwarf stars. These results will be presented at an international white dwarf conference near the end of FY14.

Thermodynamics of mixtures

We have developed a formulation for the calculation of the thermodynamics of mixtures and implemented it in a computer code. Our first test, for a published mixture of iron-helium (in the TF-MD approximation) shows an excellent agreement of better than 3% on the pressure over the full range of mixing ratios (Fe/He=0 to 1).

Publications

Much of this substantial amount of work is ready for publication. We are well along in writing a first draft of a publication of our model for mixtures.

Future Work

Diffusion coefficients

We will complete the validation of the calculation of the inter-diffusion coefficient for C/He mixture with comparisons with TF-MD simulations, establish its range of validity and generate a large table of coefficients with convenient fits for use in models of white dwarf stars. If time permits, we will do the same for another mixture of interest that has a large asymmetry, such as calcium-helium, for application to white dwarf stars.

Equation of state

After a suitable validation over the range of temperature and densities of interest, we will compute tables of the equations of state of carbon-helium and of carbon-oxygen mixtures in the WDM regime of interest for white dwarf stars.

Publications

We will submit a publication on our mixture model before the end of FY13. We will follow with a publication on the diffusion coefficients and another on the equation of state for carbon-helium mixtures.

Conclusion

The primary result will be a robust capability to calculate the equation of state and transport coefficients of warm dense mixtures using a single, unified approach with no adjustable parameters. We will develop the theoretical framework, implement the model in codes, validate the model through comparisons with experimental data and quantum molecular dynamics simulations, apply the model to study high-impact astrophysical problems related to planetary luminosity and white-dwarf stars, and advance the model to the point where it can be broadly used to generate a variety of equations of state for mixtures relevant to astrophysical, fusion, and national security research.

Publications

Saumon, D., C. E. Starrett, and J. Daligault. Diffusion coefficients in white dwarfs. To appear in 19th European White Dwarfs Workshop. (Montreal, Canada, 11-15 Aug. 2014).

Starrett, C. E., Saumon, Daligault, and Hamel. Integral equation model for warm and hot dense mixtures. 2014. PHYSICAL REVIEW E. 90 (3): 033110 (8).

Software/Hardware Mapping for Data Locality Optimization

Hristo N. Djidjev
20130252ER

Introduction

We consider the problem of mapping an existing sequential code onto a model of a multi-core high-performance computing (HPC) system so that the memory access/communication cost is minimized. This can be achieved by achieving high data access locality, one of the most important properties of efficient HPC codes. For instance, modern computer processors such as Graphics Processor Unit (GPU) and Cell have limited amount of local memory and the time of data transfer between that memory and the global memory is huge compared to the cost of computation or the cost of local access. Hence, it is important to have a method that maps the operations of a software code onto a hardware model in a way that maximizes locality and data reuse, i.e., such that as large as possible amount of computations are performed on the data in the local memory before that data is replaced with new data. Unfortunately, the corresponding mapping optimization problem is very difficult to solve efficiently as it is NP-hard. Hence, we will look at a subclass of all software codes, namely nested-loops, and at a subclass of all transformations, namely affine transformations. Previous research has shown that those subclasses capture the most relevant from practical point of view types of codes (as loops are usually responsible for most of the total computation time) and, on the other hand, result in optimization problems of manageable computational complexity. Our goal is to address the algorithmic challenges and to design mapping algorithms that are both accurate and scalable and to test their performance on a prototype mapping tool.

Benefit to National Security Missions

Co-design has been recognized as one of the high-priority areas of research for Information Science and Technology at LANL. This project focuses on a key step of the software/hardware co-design process – mapping the software representation onto the hardware model in

order to maximize data reuse and locality and increase the amount of parallelism. The success of this project will advance the ability of LANL and DOE in solving the co-design problem and building competence for achieving exascale capabilities. This will lead to computers with improved performance and price parameters, improving the existing simulation capabilities. It will positively affect multiple application areas that rely on high performance computing and computational simulation for their data analysis and prediction.

Progress

The goal for the second year was to complete the missing details of the optimization framework and to apply it to a code from the PolyBench benchmark. For that purpose, we chose the 3-point Jacobi-1D stencil and applied the Pluto tool in order to determine an optimal tile shape. Pluto is publicly available software for code parallelization and optimization based on the polyhedral method.

Having fixed the shape, the tile sizes were left as variables for an optimization problems, together with a few other software and hardware parameters. Those variables were used for developing an analytical cost model that includes analytical submodels for performance and cost. The performance model evaluates the execution time as a function of several software parameters such as tile sizes, number of tiles and number of threads per processor and several hardware ones, such as times for transferring a data unit between different memory types and synchronization costs for the Graphics Processing Unit (GPU) architecture. For the cost submodel, we chose energy as a cost measure and modeled it as a function of the above parameters plus a few additional ones such as the energy consumed for transferring data between memory units of a given type.

One of our key achievements is that we were able to

Information Science & Technology

Exploratory Research
Continuing Project

model both the time and the energy as analytical functions of the parameters that allowed us to solve the corresponding optimization problem very efficiently, in just a few seconds. That optimization problem, central to our code-sign framework, aims at finding a combination of software and hardware parameters that yields the best performance tradeoff with respect to execution time and cost, in our case cost and energy.

Our work so far showed that one of the most challenging and risky aspects of our framework, solving an optimization problem over a very high dimensional solution space, can be successfully addressed by a combination of polyhedral and performance modeling. It also yielded the first codesign solutions for the Jacobi-1D stencil and the GPU architecture, and we are currently validating and evaluating these solutions.

The reported work has been done in collaboration with faculty and students from Colorado State University and University of Rennes, France.

Future Work

During the third year, our first task is to complete the validation of the time and energy models. We will determine, by using micro-benchmarking, the values of several hardware parameters used in our time and energy models. Then we will match the times and energies predicted by the models and those found by measuring and, by comparing them, will calibrate the model and analyze its accuracy.

We are also planning to use more advanced tiling methods applicable to high-dimensional codes, such as the hybrid hexagonal tiling by Grosser et al. and to develop the corresponding optimization frameworks. That will allow us to apply the methodology to 2D stencils such as Jacobi-2D.

We will furthermore extend the results to multi-GPU systems, which generally is a very challenging task. However, thanks to our polyhedral approach, this task can be made feasible by generating higher-level tiles that can be sent to different GPUs, combined with the lower-level tiles already used in our single-GPU model. That will increase the number of variables of the optimization problem, but given the efficiency of the existing optimization algorithm, we expect the problem to be solvable in very reasonable time.

Another interesting problem that we hope we will have time to work on is combining several different codes into the same optimization problem. That will correspond to the problem where a hardware platform has to be optimized for executing several, rather than a single, algorithm.

We are planning to write several papers summarizing our results and submit them to prestigious conferences.

Conclusion

We will formulate several versions of the optimization problem discussed above and develop efficient algorithms for their solutions. We will combine our new algorithms in a proof-of-principle tool and will test it on optimizing nested loops for GPU type architectures. The loops will be chosen both from simple linear algebra and numerical methods codes during the development phase, as well as on advanced codes used at LANL (e.g., in molecular dynamics simulations) for which GPU type implementations exist. The goal will be to compare the quality of our solution against hand-optimized GPU implementations in order to validate the results.

Publications

- Aleksandrov, L., H. Djidjev, A. Maheshwari, and J. R. Sack. An Approximation Algorithm for Computing Shortest Paths in Weighted 3-d Domains. 2013. DISCRETE & COMPUTATIONAL GEOMETRY. 50 (1): 124.
- Djidjev, H., S. Thulasidasan, G. Chapuis, R. Andonov, and D. Lavenier. Efficient multi-GPU computation of all-pairs shortest paths. 2014. In IEEE International Parallel & Distributed Processing Symposium (IPDPS) . (Phoenix, May 19-23, 2014). , p. 360. Phoenix: IEEE.
- Djidjev, H., S. Thulasidasan, G. Chapuis, R. Antonov, and D. Lavenier. Accelerating graph algorithms using graphics processors: shortest paths for planar graphs. 2014. ADTSC Science Highlights.
- Djidjev, H., and M. Onus. Using graph partitioning for efficient network modularity optimization. 2013. GRAPH PARTITIONING AND GRAPH CLUSTERING. 588: 103.
- Djidjev, Hristo N.. Parallel seed-based approach to protein structure similarity detection. 2013. Los Alamos National Laboratory, LA-UR-13-27448.
- Djidjev, Hristo N.. Efficient Shortest Path Computations on Multi-GPU Platforms. 2013. Los Alamos National Laboratory, LA-UR-13-26585.
- Djidjev, Hristo N., Guillaume Chapuis, Sunil Thulasidasan, and Rumen Andonov. On Solving the Shortest Path Problem for Planar Graphs using Graphics Processors. 2012. Los Alamos National Laboratory, LA-UR-12-25700.
- Djidjev, Hristo N., Rumen Andonov, Sanjay Rajopadhye, and Vamsi Tandrapati. Co-Design Optimization of Jacobi Kernel for GPU Architectures. 2013. Los Alamos National Laboratory, LA-UR-13-28110.

Djidjev, Hristo N., Sunil Thulasidasan, Rumen Andonov, Guillaume Chapuis, and Dominique Lavenier. Efficient Multi-GPU Computation of All-Pairs Shortest Paths. 2013. Los Alamos National Laboratory, LA-UR-13-28111.

Wohlers, I., M. Le Boudic-Jamin, H. Djidjev, G. Klau, and R. Antonov. Exact Protein Structure Classification Using the Maximum Contact Map Overlap Metric, , 2014. Presented at International Conference on Algorithms for Computational Biology (AlCoB). (Tarragona, Spain, July 1-3, 2014).

Contextual Learning and Recognition

Alexei N. Skurikhin
20130265ER

Introduction

Event and object recognition requires analysis of massive quantities of data to detect and identify static or dynamic patterns of interest. One challenge for automated object recognition, and machine learning in general, arises from the fact that in spite of huge and growing quantities of data, complex event recognition often remains ill-posed. The object recognition ambiguity can be addressed by exploiting the fact that events rarely occur in isolation; they tend to co-occur and co-vary, and this correlation structure, known as context, provides important information for the disambiguation of the event. However, while being extremely useful for disambiguation of events and objects, such context-aware knowledge discovery typically leads to a significant increase in the number of features to be analyzed. Modeling contextual information and scaling machine learning methods for context aware object recognition to large problems are among the most challenging issues in developing the next generation of information extraction approaches.

We aim to develop novel efficient machine learning and inference methods for context aware probabilistic recognition of complex events and objects based on Markov and Conditional Random Fields. Development of scalable context learning and inference methods for probabilistic object recognition will have implications in many domains, such as computer vision, image interpretation, bioinformatics, text analytics, and web search. Furthermore, the problem of efficient learning and inference in general structure random fields is closely related to several important combinatorial optimization problems. Methods developed in this project will therefore facilitate progress in combinatorial optimization, probabilistic graphical modeling, and related areas.

Benefit to National Security Missions

This project contributes to addressing the Information Science and Technology Grand Challenge - the develop-

ment of breakthrough mathematics and computer science required to extract knowledge from massive quantities of data. Current approaches to event and object recognition in imagery are overwhelmed by the number of images, the sizes of images (e.g., high-resolution satellite image can be up to 10^9 pixels and larger), and the diversity of visual features associated with objects of interest. Current approaches are also facing a need to deal with increasing use of signature suppression, camouflage, concealment, and deception. Context aware data mining will provide an ability to disambiguate data interpretation and focus human analysts on “hot spots” in such data.

The project is also related to the Threat Reduction mission. If successful, our methods will increase the productivity of human analysts, optimize the use of high-value sensors (which typically have a narrow field of view) for monitoring of wide areas, and improve the timeliness and accuracy of decision making.

Progress

We posed contextual Conditional Random Fields based modeling and learning as a structured machine learning problem, which is about learning knowledge from data with internal structure in the form of one or more relations between co-occurring objects.

We made advancements in developing approaches to approximate inference and learning of general models via decomposition and message scheduling techniques. The key problem is that the contextual modeling based on graphical probabilistic models faces a challenge of computational intractability of inference if underlying probabilistic graphical model contains cycles. This is the case in many real world cases. Therefore, computationally efficient inference is crucial for both learning and recognition, as they both require performing inference to assign classification labels to objects. We continued

our research on the use of pseudo-likelihood approximation of the true likelihood of the original loopy graphical model, and evaluated it using synthetic and real-world datasets. We have extended work on pseudo-likelihood likelihood approximation by considering larger composite blocks over which approximate inference is done. We also investigated and developed an approach how to decompose loopy graphical model into a set of tractable acyclic sub-graphs which are combined into an approximate model. The acyclic sub-graphs are combined in a special architecture so that they improve upon each other to better approximate the true loopy graphical model. We plan to extend this work next year. We also investigated and validated asynchronous tree-based message passing scheduling that was used to approximate the true likelihood. This makes inference more efficient than frequently used loopy belief propagation scheme. This is another line of research that will be extended into next year. Based on our results, we have produced two journal publications, two papers publications (in books), one conference paper submitted, and one conference paper is under preparation.

Future Work

We plan to investigate and develop algorithms for maximum a posteriori and maximum posterior marginal estimation in probabilistic graphical models. We will focus on tree-structured approximations of probabilistic inference, learning and approximate computation of marginal distributions for Conditional Random Fields.

For validation, we will utilize datasets used in the computer vision community.

Conclusion

Our goal is to develop efficient machine learning and inference algorithms for probabilistic modeling of contextual information and context-aware object recognition based on Markov and Conditional Random Fields (M&CRFs). This will broadly entail investigating and developing efficient algorithms for approximation of probabilistic inference in graphical models and learning M&CRF based contextual models. While developing these algorithms will have implications in many problem domains, we will focus on computer vision, on a challenging problem of object recognition in an unconstrained environment, for validating our algorithms.

Publications

Burr, T., and A. N. Skurikhin. Approximate inference options in data models for image analysis. 2013. presented at the Statistical Image Analysis Workshop, Santa Fe, NM, LAUR 13-21603.

Burr, T., and A. N. Skurikhin. Conditional random fields for inverse problems in structured data. 2014. In Encyclopedia of information science and technology. Edited by Khosrow-Pour, M., Third Edition, p. 6167. Hershey, PA, USA: IGI Global.

Burr, T., and A. N. Skurikhin. Algorithms for approximate Bayesian computation. 2014. In Encyclopedia of information science and technology. Edited by Khosrow-Pour, M., Third Edition, p. 1559. Hershey, PA, USA: IGI Global.

Burr, T., and A. Skurikhin. Pseudo-likelihood inference for Gaussian Markov random fields. 2013. Statistics Research Letters. 2 (3): 63.

Burr, T., and A. Skurikhin. Selecting summary statistics in approximate Bayesian computation for calibrating stochastic models. 2013. BioMed Research International. 2013: 10 pages.

Skurikhin, A. N.. Learning tree-structured approximations for conditional random fields. To appear in the Applied Imagery Pattern Recognition (AIPR) annual workshop. (Washington, D.C., 14-16 Oct. 2014).

Skurikhin, A. N.. Hierarchical spanning tree-structured approximation for conditional random fields: an empirical study. To appear in the International Symposium on Visual Computing. (Las Vegas, NV, 8-10 Dec. 2014).

Skurikhin, A. N., S. R. Garrity, N. G. McDowell, and D. M. Cai. Automated tree crown detection and size estimation using multi-scale analysis of high resolution satellite imagery. 2013. Remote Sensing Letters. 4 (5): 465.

A New Approach to Multiscale Plasma Physics Simulations

Gian L. Delzanno
20130334ER

Introduction

Plasmas are characterized by a wide range of spatial and temporal scales, and pose a formidable challenge to the numerical modeling and to our ability to perform predictive simulations. This project focuses on a new method that promises to solve some longstanding issues in computational plasma physics and, in particular, of Particle-In-Cell (PIC) approaches (which are commonly used to model microscopic plasma phenomena). Ours is essentially a spectral approach, where the distribution function in velocity space is not handled by superparticles as in PIC, but by an expansion in a suitable basis. The method is then cast as a series of partial differential equations for the coefficients of the expansion. First, our preliminary results indicate that this approach can achieve machine precision accuracy with a relatively low number of basis functions and at a small fraction of the computational cost incurred to obtain a (much less accurate) solution with a PIC code. Second, since the low order terms of the expansion correspond to the typical macroscopic moments (density, mean velocity and energy), the microscopic/macroscopic coupling critical to multiscale plasma physics is naturally built-in. We have successfully demonstrated on a test case that we could use very few basis functions in certain regions of the computational domain (where the plasma behaves as a macroscopic fluid) while retaining many more basis functions in other areas (where the microscopic details of the plasma are important). Third, the algorithm can make effective use of emerging architectures, such as GPUs, for the optimization of the basis functions. The goal of this project is to develop the spectral capability just described for general multiscale plasma physics problems. As a case study, we target an application relevant to space weather, an important area for LANL mission in threat reduction and global security.

Benefit to National Security Missions

The capability focus of this project could be a game-

changer in the field of computational multiscale plasma physics since (1) the problematic coupling of macroscopic and microscopic scales needed in many problems of interest is naturally handled by the method and (2) it offers the possibility for much more accurate results at a fraction of the computational cost obtained by conventional approaches. As such, any application where plasmas are important will benefit from this capability. It is immediately relevant to the DOE/NNSA nuclear weapons mission, but it also includes agencies such as DOE (office of science), NASA (space science) and DOC (NIST and NOAA). It will also impact many areas of LANL mission, including nuclear weapons, energy security and global security/space situational awareness.

Progress

We concluded the comparison between the implicit version of the Fourier-Hermite capability and the implicit Particle-In-Cell (PIC) on standard test cases such as Langmuir waves, Landau damping, two-stream instability and ion acoustic waves. This comparison was carried out in the one dimensional electrostatic limit. The results confirmed the trend obtained with the explicit/semi-implicit version of the two algorithms, that is that the Fourier-Hermite method can be orders of magnitude faster and more accurate than PIC. Two papers have been submitted to Journal of Computational Physics and are currently under review.

The formulation of the algorithm was extended to two dimensions and to the fully electromagnetic case according to the Vlasov-Maxwell kinetic description of a plasma. The spatial discretization is still treated spectrally with a Fourier expansion while the time discretization is fully implicit and based on the Crank-Nicolson scheme. The discretized non-linear equations are solved with a Jacobian-Free Newton-Krylov method which uses a standard GMRES solver for the inner linear iterations. The resulting code has been developed in Matlab to

take advantage of very efficient convolution routines. The code has been successfully tested against Langmuir waves, Landau damping, and Weibel and whistler instabilities. Further testing is underway, particularly with regard to the non-linear phase of the instabilities mentioned above. We also plan to port the code to Fortran in order to reduce the code run time.

The extension of the method to multi-dimensions is challenging because the number of unknowns increases significantly, and requires some optimization of the numerical algorithm. Here we have followed two approaches. First, we have developed a preconditioner to improve the convergence of the gmres iterations. The preconditioner is based on the solution of the advection part of the Vlasov equation and on Maxwell's equations. The resulting matrix does not depend on the previous iterate of the Newton-Krylov procedure and therefore only needs to be inverted once at the beginning of the simulation. This is done by an incomplete LU decomposition. Despite its simplicity the preconditioner performs quite well and for the examples discussed above the ratio between linear to non-linear iterations has been consistently less than two. Second, we are investigating a procedure for the optimization of the Hermite basis through six free parameters (in three dimensions and for each plasma species) that correspond to shifting and rescaling the basis argument. This optimization theory is based on the minimization of the quadratic error and derives analytic expressions for the free parameters. We have started testing the optimization procedure.

We have been working on a discontinuous Galerkin (DG) spatial discretization of the Hermite expansion of the Vlasov equation in the one dimensional electrostatic limit. The motivation for choosing a different discretization (relative to the Fourier expansion) is its enhanced flexibility and ability to handle efficiently very localized features like shocks. Presently, the DG code solves the linear part of the model for arbitrary number of moments of the Hermite expansion and for arbitrary spatial order. We are currently implementing the Poisson solver using the same DG discretization. Once the Poisson solver is tested, the fully nonlinear system of equations arising from the implicit time discretization will be solved again with a Jacobian-Free Newton-Krylov technique. The DG code will then be tested against the same standard test problems described above and used to prove its ability to change the number of expansion moments in different parts of the domain.

As part of our solver implementation, we have adapted a grid decomposition method called Hierarchical Hybrid Grids (HHG) to the data structures used to represent the Hermite system of equations. This decomposition simpli-

fies the handling variable moment expansions in different domain regions, and also allows for geometric adaptivity in conjunction with the velocity space capabilities that are the core focus of our work. The core data structures used in the HHG implementation allow increased computational efficiency and are well-aligned with the requirements of modern computing architectures.

Future Work

The proposed work will continue to build on the working version of the Hermite spectral capability that we have developed in the following ways:

1. Continue the extension of the code from one to two dimensions, in order to apply it to more complex problems. This is a milestone for the project.
2. Begin the extension to the electromagnetic case.
3. Explore preconditioning techniques for the linear iterations of the Newton-Krylov solver to speed-up the convergence of the method.
4. Exploit the CPU/GPU infrastructure that we have built to study the choice of the optimal base for the Hermite expansion. This technique relies on the assumption that the plasma does not change much during few time steps of the simulation so that the optimization can be performed asynchronously. Therefore we will quantify the level of asynchronism that can be exploited, the code speed-up and the accuracy of the resulting technique. This is another milestone for the project.
5. The code will be verified against standard test cases. We will also continue benchmarking against PIC codes since our metric for success is to prove that our new technique can be much more accurate and faster than PIC, which is the community standard.

Conclusion

This project will deliver an electromagnetic, parallelized code that models a collisionless magnetized plasma. The code will be compared against available PIC codes (the dominant method in the community) and our metric for success will be based on the comparison in terms of accuracy, efficiency and code speed-up. We expect that our tool will outperform PIC codes, as our preliminary results indicate. If we can indeed confirm the huge savings factors of our approach relative to PIC, it will be a breakthrough in computational plasma physics that can impact many plasma applications, such as space weather or magnetic fusion energy.

Publications

Camporeale, E., G. L. Delzanno, B. Bergen, and J. D.

Moulton. Fourier-Hermite spectral method for the Vlasov equation. Presented at 55th Annual Meeting of the APS Division of Plasma Physics. (Denver, 11-15 Nov 2013).

Camporeale, E., G. L. Delzanno, B. Bergen, and J. D. Moulton. On the velocity space discretization for the Vlasov-Poisson system: comparison between Hermite spectral and Particle-in-Cell methods. Part 2: fully-implicit scheme. *Journal of Computational Physics*.

Camporeale, E., G. L. Delzanno, B. Bergen, and J. D. Moulton. On the velocity space discretization for the Vlasov-Poisson system: comparison between Hermite spectral and Particle-in-Cell methods. Part 1: semi-implicit scheme. *Journal of Computational Physics*.

Delzanno, G. L.. Multi-dimensional, fully-implicit, spectral method for the Vlasov-Maxwell equations with exact conservation laws in discrete form. *Journal of Computational Physics*.

Delzanno, G. L., B. Bergen, J. D. Moulton, B. Srinivasan, and E. Camporeale. Spectral method for the solution of the Vlasov equation based on Hermite polynomials. Presented at American Physical Society Division of Plasma Physics Meeting. (New Orleans, 27-31 Oct 2014).

Delzanno, G. L., E. Camporeale, B. Bergen, J. D. Moulton, B. Srinivasan, and G. Manzini. Fully implicit spectral method for the solution of the Vlasov equation based on Hermite polynomials. Invited presentation at 2014 US-Japan JIFT Workshop on Progress in kinetic plasma simulations. (New Orleans, 31 Oct-1 Nov 2014).

Delzanno, G. L., E. Camporeale, B. Bergen, and J. D. Moulton. Fully-implicit Fourier-Hermite spectral method for the Vlasov equation. Presented at Vlasovia 2013. (Nancy, France, 25-28 Nov 2013).

Sparse, Distributed, and Robust Network Control

Marian Anghel
20130558ER

Introduction

The goal of this project is the design of distributed controllers for complex interconnected systems. Although emerging network control applications include large mechanical structures, distributed sensing, and interacting mobile robot agents, the focus of this project is the design of distributed controllers for large scale power grid systems.

This project aims to address two critical weaknesses of power grid systems. First, the current power grid has not yet fully embraced the most recent advances in distributed sensors, embedded computing systems, and advanced communication networks. Second, the power grid faces the simultaneous convergence of several emergent difficulties (intermittent renewable energy sources, frequent transmission congestions, relentless market pressure) which the existing centralized control infrastructure will not be able to solve.

In response to these challenges, this project seeks to construct an algorithmic synthesis of nonlinear and distributed control techniques for large networked power systems. More specifically, we propose a decentralized approach which exploits separability and decomposition of the corresponding control problem into nonlinear sub-problems which can be solved locally and efficiently. This project explores new ideas from compressed sensing, convex optimization, and algebraic geometry, that have the potential to radically change the ability to formulate the stability and control of the future Smart Grid (and in general large networked dynamical systems). Success of this project will position LANL at the forefront of this research and enable engineering control systems to be developed that can operate at the global network scale.

Benefit to National Security Missions

Recent workshops organized by the Department of

Energy (DOE) in partnership with Office of Electricity Delivery and Energy Reliability (OE) were focused on the challenges of grid modernization efforts (March 2009) and on the computational needs for the next generation electric grid (April 2011). The proposed research directly supports these program development directions.

More specifically, the report on “Advanced Control Methods” conducted by the National Energy Technology Laboratory for the DOE in 2007 has identified the need for the development of distributed intelligent agents that respond rapidly at the local level to unburden centralized control systems. Our project directly addresses this problem by developing a distributed control methodology which is robust with respect to system disturbances.

Furthermore, the Smart Grid Research and Development Program of the DOE/OE, identifies in its multi-year program plan the development of advanced control methods. As the smart grid evolves, this program notes that more complex automated control systems will be necessary to maintain optimum operation of the grid. The control algorithms that will be investigated in this project directly address the fundamental conceptual challenges posed by such automated control systems. Finally, the April 2011 DOE workshop, “Computational Needs for the Next Generation Electric Grid Proceedings,” highlights a class of mathematical and computational problems relevant for potential power systems research. It identifies, in particular, the difficulties currently encountered by direct transient stability analysis methods. This project directly addresses this problem and our preliminary results have already offered significant breakthrough results based on novel algebraic control techniques.

Progress

In the second year of the project we have implemented

a decomposition aggregation approach to study the stability of dynamic networks of increasing size. The analysis employs the theory of positive polynomials, semidefinite programming, and sum of squares (SOS) decomposition that have been employed in the first year of the project to compute Lyapunov functions for dynamic systems. The global stability analysis relies on results obtained in the first year of the project when we have used a decomposition technique to compute a partition of the network into a number of weakly interacting subsystems. We have also computed Lyapunov functions for each isolated subsystems and estimated the region of attraction (region of stability) of each isolated subsystem.

The research question that we have addressed in the second year was the following. Using the stability analysis of individual, non-interacting subsystems, assess the global stability of the composite system when the interactions between subsystems is switched on.

We have provided two answers to this question. The first one relies on building a comparison linear system whose states are the subsystem Lyapunov functions. If given a disturbance of the original system the linear comparison system is stable, then our original system, whose state is bounded by the state of the comparison system, is also stable. This is a classical result. Nevertheless, we have improved it using SOS techniques and obtaining tighter comparison systems that provide better estimates for the ROA of the original system.

Our second approach is original. It is based on the generalization of classical stability analysis when the analyzed subsystem is subjected to bounded disturbances produced by interactions with the other subsystems. This approach also relies on using SOS techniques and has the advantage of keeping the analysis “local.” Therefore, this approach scales linearly with the network size and enables us to analyze the stability of very large systems. On the other hand, since this local stability analysis can detect the subsystems that are unstable under an external perturbation, will enable us to design adaptive and distributed control strategies in the third year of the project.

Finally, we have applied the two stability analysis algorithms that we have designed to study the stability of two different networks: first, power system networks and, second, networks composed of interacting Van der Pol oscillators.

Future Work

In the third year of the project we will start designing distributed control strategies. More specifically, we will seek

to stabilize the system by using a multilevel control scheme based upon the decomposition-aggregation stability analysis developed in the second year of the project. This strategy first designs local controllers that stabilize each subsystem when decoupled from the rest of the system, while global controllers are applied to reduce the effect of interconnections among the subsystems (minimize the effects of interactions between the subsystems).

We will introduce a number of innovations to this classical design strategy. First and foremost, we will generalize the classical linear analysis to nonlinear systems using the algebraic geometric approaches introduced in the first two years of the project for the computation of Lyapunov functions and for the distributed stability analysis.

Second, we propose to design adaptive, real-time controllers that depend on the current state of the system. As our previous distributed stability analysis has shown, this approach will be less conservative and will incur smaller control costs.

Finally, we will implement this control strategy to power system networks as well as to networks composed of interacting Van der Pol oscillators.

Conclusion

This project will provide for the first time a methodology for the algorithmic construction of Lyapunov functions and for the design of distributed, nonlinear controllers for power grid systems.

The algorithm will use sparsity constraints to control the complexity of the controllers and a hierarchical decomposition methodology in order to extend modern nonlinear algebraic control techniques to large scale distributed systems.

The successful completion of this project will generate a renaissance of direct analysis methods based on Lyapunov techniques and will open new research directions in the distributed control of power grid systems.

Publications

Anghel, M., F. Milano, and A. Papachristodoulou. Algorithmic Construction of Lyapunov Functions for Power System Stability Analysis. 2013. IEEE Transactions on Circuits and Systems I: Regular Papers. 60 (9): 2533.

Anghel, M., J. Anderson, and A. Papachristodoulou. Stability Analysis of Power Systems using Network Decomposition and Local Gain Analysis. 2013. In Bulk Power System Dynamics and Control Symposium.. (Crete,

Greece, 25-30 Aug. 2013). , p. 1. NA: IEEE Explore.

Kundu, S., and M. Anghel. Sum-of-Squares Approach to the Stability Analysis of Inter-connected Systems. Presented at SCONES 2014, IEEE Symposium on the Control of Network Systems.. (Boston, 27-28 Oct. 2014).

Motter, A. E., S. A. Myers, M. Anghel, and T. Nishikawa. Spontaneous synchrony in power-grid networks. 2013. NATURE PHYSICS. 9 (3): 191.

From the Finite Element Method to the Virtual Element Method

Gianmarco Manzini
20140270ER

Introduction

This project aims at the development of a new family of numerical methods on polygonal and polyhedral unstructured meshes for diffusion, reaction-diffusion and convection-diffusion problems, the Stokes equations and compressible and incompressible elasticity equations.

These methods are a generalization of the Finite Element Method (FEM) to polygonal and polyhedral meshes and are based on the very new paradigm of Virtual Element Methods (VEMs). In the virtual framework, only the part of the finite element space that refers to polynomials is constructed, while the behavior of the method on the rest of the space is approximated following a stability criterion. This fact has a dramatic impact on the computational complexity that is greatly simplified as the implementation of virtual elements does not require the explicit construction of the shape functions anymore.

Benefit to National Security Missions

The success of this research will provide unique capabilities in the DOE complex that combine world-class algorithms, their theoretical foundation and high-end HPC technologies. This new class of numerical algorithms may be outstanding for mathematical models used in Environment (Climate and Energy Impact), (Climate and Energy Impact) and Scientific Discovery and Innovation (Nuclear, Particle, Cosmology, Astrophysics, Basic Understanding of Materials, Information Science and Technology).

Progress

In the past nine months we made a significant progress in the construction of the Virtual Element Methods (VEM) for the case of the pure diffusion equation and the cases when convection and reaction terms are present. In particular, we proved that the VEM provides a general theoretical setting for the Belytschko stabilization that fixes the hourglass instability and we devel-

oped and analyzed a new formulation of the VEM that is based on a non-conforming choice of the degrees of freedom.

Furthermore, a new approximation strategy has been designed to include the numerical treatment of the convection and reaction terms into the framework of the VEM for the diffusion equation. This new algorithm has been extensively tested in the diffusive regime for which it showed the optimal order of convergence that is expected from theoretical arguments.

We are currently working to extend the new non-conforming VEM to the convection and reaction terms and with a PhD student from Oregon State University to develop a stabilization strategy for the convection-dominated regime. Our results were partially submitted for publication to two leading international journals (International Journal for Numerical Methods in Engineering and SIAM Journal on Numerical Analysis), were presented in invited talks at the Departments of Mathematics at Oregon State University and University of Milano-Bicocca (Italy) and will be presented upon invitation in July 2014 at the London Mathematical Society Durham Symposium in Durham, UK, and at the World Congress of Continuum Mechanics in Barcelona, Spain.

Future Work

We will extend the development and implementation of the virtual element method (VEM) formulation for reaction-diffusion problems and convection-diffusion problems in 3D. This is a highly non-trivial process.

We will develop and implement the VEM formulation for the steady Stokes problem. The numerical approximations will have the following features:

- (a) suitable for 2D applications;
- (b) order of accuracy higher than one;
- (c) order of regularity higher than zero.

Develop a Hessian-based a posteriori error estimator and implement an efficient mesh adaptive strategy for numerical approximations for problems with strong gradient regions.

Conclusion

The expected results are the developments of a new class of methods and their characterization with respect to accuracy, efficiency, and effectiveness for important applications where the VEM can outperform the existing computational technologies. The virtual element algorithms may impact a wide range of modeling multi-physics applications, including climate and environmental modeling (e.g., climate, ocean and sea-ice modeling, ASCEM Project, Arctic Terrestrial Simulator), plasma physics (e.g., Fokker-Planck equation in inertial confinement fusion simulations) and other CFD-based applications.

Publications

Cangiani, A., G. Manzini, A. Russo, and N. Sukumar. Hourglass stabilization and the virtual element method. *International Journal for Numerical Methods in Engineering*.

Cangiani, A., G. Manzini, and O. Sutton. The Conforming Virtual Element Method for the convection-diffusion-reaction equation with variable coefficients. 2014. Los Alamos National Laboratory LA-UR-14-27710.

Cangiani, A., G. Manzini, and O. Sutton. Numerical results using the conforming VEM for the convection-diffusion-reaction equation with variable coefficients. 2014. Los Alamos National Laboratory LA-UR-14-27709.

Dios, B. Ayuso da, K. Lipnikov, and G. Manzini. The non-conforming virtual element method. *SIAM Journal on Numerical Analysis*.

Gyrya, V., G. Manzini, and D. McGregor. A non-conforming virtual element discretization for singularly perturbed advection diffusion reaction equations. 2014. Los Alamos National Laboratory LA-UR-14-27995.

Large Fluctuations in Stochastic Dynamical Systems

Timothy C. Wallstrom
20140302ER

Introduction

The goal of this project is to understand dynamical systems in the presence of large random fluctuations. Such systems are common in economics, physics, and several areas of biology. The usual analyses of random systems make certain technical assumptions on the size of the fluctuations, which are invalid when the fluctuations are too large. For these types of random systems, the usual analyses are invalid, and new methods are required.

We focus on the dynamical systems that govern evolution, and specifically on the area of population genetics, which is the mathematical framework for the study of evolution. These systems are sufficiently rich to exhibit a broad range of phenomena. On the other hand, striking recent mathematical results have led to a complete characterization of the solution classes, under large fluctuations, of the equations of population genetics, in certain simple cases. Thus, these systems should be tractable, but rich enough to provide general insights.

Our objective is to illuminate the dynamics of specific realistic dynamical systems by connecting such systems to the general theory. In short, we want to connect the data to the theory. The value of such an analysis has been amply demonstrated in the case of small fluctuations, and we expect similar dividends in the case of large fluctuations.

We will test our formalism by applying it to the understanding of HIV evolution in the infected individual. HIV is the Human Immunodeficiency Virus, which is the causative agent in AIDS. Existing models of HIV evolution have led to a number of stubborn mysteries, which we trace to an inadequate modeling framework, which does not account for large fluctuations. There is empirical evidence of large fluctuations in HIV, and modern sequencing technology will permit detailed comparison of our models with experimental data.

Benefit to National Security Missions

Our work will contribute to the understanding of dynamical systems in the presence of large fluctuations, which is an area of mathematics of importance to both the Office of Science (DOE/SC) and the NSF (Other Federal Agencies). The particular application on which we will focus on is evolutionary dynamics, which is of broad interest, and is a central concern of Fundamental Bioscience. We believe our models will describe evolutionary dynamics in a large number of areas of biology. We will be focusing specifically, however, on the evolution of HIV in the infected patient. Such research is of direct interest to the NIH. The tools we develop will be valuable for future advances in our understanding of HIV and other pathogens, such as influenza, which will have importance for Basic Health Research.

Progress

During this past year, we have studied the effect of very large family sizes on genealogies. We are interested, in particular, in the case that the descendants of a single individual constitute a significant fraction of the next generation in some large population. Such family sizes do not arise with human beings, but they do arise in nature. For example, in the Pacific Oyster, about 10% of the individuals in a given population are sometimes the children of a single individual from the previous generation. Large family sizes may also arise, in a somewhat more complicated way, in the reproduction of the HIV (Human Immunodeficiency Virus) within an infected human. HIV is the causative agent in AIDS (Acquired Immunodeficiency Syndrome), and is a key focus of our project and potential application for our work.

We have used two well-known and mathematically precise but idealized models for the how a population propagates itself from generation to generation: the so-called Moran and Wright-Fisher models. We studied these models both computationally and mathemati-

cally in the context of “large fluctuations,” which in this case means large family sizes. It was already known that many of the details of the family size distributions become irrelevant when the population size becomes large. Thus, even though there are many different characteristics of the family size, there are only a few types of possible genealogies in the limit of a large population.

Our most significant result this year was to relate this genealogical classification to a more general classification that arises in the theory of extreme events. This latter theory has been used to predict the probability of extreme events, such as the “100-year flood,” devastating earthquakes, extreme stock-market fluctuations, exceptional longevity, and so on. Here again, there is a classification result: there are only a few ways in which the probability can decrease as the events become more extreme. Sometimes it is possible to tell what class a particular phenomenon belongs to by looking at less extreme events, such as the biggest flood in a ten-year period. Using the general theory, one can then estimate how big the largest flood is likely to be in hundreds or thousands of years, periods that are far too long for direct observation. Such an estimate can be useful for engineering purposes, such as determining how large a retaining wall should be in order to protect against extremely rare but catastrophic flood.

What we discovered, and what was not previously known, was that these two classifications---of genealogies and of extreme events---are identical. Having made this connection, we now plan to exploit the general theory of extreme events for understanding genealogies, in situations when the family size can become very large.

Another key accomplishment for this year has been the development of computer codes for simulating genealogies from our models. Computer simulations are essential for bridging the gap between our idealized mathematical models and actual populations. In deriving our mathematical results, we often make assumptions that we hope are good approximations for realistic populations, but which are not strictly valid. For example, if we are interested in the behavior of large populations we may assume that the population is infinite, even though any real population is of course finite. We can use computer simulations to test how good this approximation is for a finite population. These simulation codes have prepared us for subsequent work on this project, which will involve both finite populations and elaborations of our existing models.

Future Work

In the next year, the second of this project, we will work on three main topics.

The first topic will be the connection between extreme-value theory and large fluctuations. We discovered this connection in the first year of this project, and we believe that it provides a new and powerful perspective on understanding genealogies in the presence of large family sizes. We will develop this perspective, which holds potential for both the interpretation and technical analysis of large fluctuations.

A second goal will be to extend our results to finite populations. Our current mathematical results apply to the idealized case of an infinite population, and should be good approximations when the population is very large. But we would like to quantify how good this approximation is, to quantify the population size at which this approximation starts to break down, and to understand the way in which it breaks down. Moreover, at finite population sizes, the difference between the Kingman coalescent and the Lambda coalescents are not sharp: One should see both kinds of behavior simultaneously, and the relation between them is interesting to study. These questions can be addressed partly through mathematical analysis, but a thorough investigation will require simulation, using and extending the tools developed during the first year of our project.

A third topic will be the comparison between our results and experimental data on the evolution of the HIV virus within an infected patient. Although we expect most of the comparison effort to take place in the third year of our project, in the second year we will begin identifying appropriate sources of data for analysis and we will do preliminary analyses for signatures of large fluctuations in these datasets.

Conclusion

This project will lead to methods for connecting realistic stochastic dynamical systems to their solution classes, to an understanding of how progressive adaptation takes place in a predator-prey environment, and to clarification of the appropriate framework for modeling HIV evolution within the host.

Publications

Bhattacharya, T., E. Giorgi, T. Wallstrom, P. Hraber, G. Learn, T. Kreider, Y. Li, F. Gao, B. Korber, B. Hahn, and G. Shaw. Detecting Selective Sweeps in HIV. 2014. Presentation to Scientific Leadership Group of Center for HIV/AIDS Vaccine Immunology (CHAVI), July 30, 2014. Chosen for presentation to full CHAVI collaboration meeting, and presented there on September 29, 2014..

Accelerating Time Integration for Multi-scale Simulations

Shengtai Li
20140323ER

Introduction

One of the most difficult challenges in multiscale simulations is to bridge the gap between different time scales. The time step for the fast timescale variables tends to be so small that the slow-scale variables have to wait a long time until the micro-step simulation finishes a macro-step. To overcome this limitation in time scales is becoming the key for the practical use of the multiscale simulations. The primary goal of this proposal is to develop an innovative numerical framework to accelerate the time integration for the multi-time-scale problems. To achieve this goal, we identify two major objectives. First, we will construct low dimensional, coarse-grained, effective reduced order models (ROM) via analytical and numerical approximations. The ROM serves two purpose in our simulations: either the cost of each time step of simulation is sharply reduced, or a large time step is allowed by removing the dynamics of fast components, or both. Second, we will accelerate the time integration via parallel-in-time (PIT) strategy. By construction, the ROMs only capture the original full microscopic dynamics approximately. In many cases, the microscopic simulations with small time step is needed over the entire time domain to capture long time dynamics correctly, or at least in some small regions. The PIT strategy proposes to break the global problem of time evolution into a series of independent evolution problems on smaller intervals. Initial states for these problems are supplied by a less accurate but fast sequential time integrator, for example by using ROM. The smaller independent evolution problems can then be solved in parallel using more expensive and more accurate integrators. An iterative procedure is used to ensure that the algorithm converges to the solution one would have obtained using a purely sequential fine propagator over the entire time-domain.

Benefit to National Security Missions

The need for multiscale simulation capability is pervasive in many areas of science and engineering, including en-

vironmental and geosciences, climate, materials, combustion, high energy density physics, fusion, bioscience, chemistry, power grids and information networks. In the past 20 years, numerical techniques, such as domain decomposition and adaptive mesh refinement (AMR), have been developed to bridge different length scales. However, the total elapsed time of the simulation is limited by the fastest timescale in the system, because it is often necessary to use the same small time step for the whole system to avoid instability and unphysical artifact.

Numerous challenges arise in enabling applications to run effectively on next-generation, extreme-scale computing systems. One of the bottlenecks in current parallelism is that spatial parallelization can be easily saturated for a fixed spatial grid resolution sufficient to obtain convergence results: adding more processors above a critical number will slow down the simulation due to the communication overhead.

We propose to develop a reduced order model (ROM) and parallel in time method to accelerate the time integration in multiscale simulations, and to resolve the parallel saturation issue for future exa-scale computing. Our numerical techniques can be applied to many multiscale problems, including but not limiting to defect (e.g., crack) formation and propagation in solid material, magnetic reconnection layer in plasma physics, interface or front propagation in combustion, interface formation and propagation during phase transition in multi-phase flow simulations, and the dust and gas coupling in disk-planet simulations, etc.

Progress

We developed a reduced order model (ROM) for the dusty disk simulations using both analytic and numerical approximation. We first split the whole system into several sub-systems according to the different time scales. For each sub-system, we use partial equilibrium method

to obtain an analytic solution for the dust dynamics and then apply a predictor-corrector method to update the coupled gas dynamics. This procedure improves the time step by at least two-order of magnitudes.

We tested the ROM for our dusty disk simulations and compared the results with those obtained via very small time step method. We find that ROM works quite well when the dust to gas ratio is less than one. However when the dust to gas ratio is larger than one, which usually occurs at later time in very limited small regions where the dust particles are highly concentrated. A new ROM and parallel-in-time approach has to be developed for those region.

A spectral deferred correction (SDC) algorithm was applied to our operator-splitting method. We can only achieve second order convergence rate when using the operator-splitting method. By combining the SDC with operator-splitting method, we can achieve a higher order convergence rate. We also find that the SDC approach can increase computation cost/time by several times, depending on the number of iterations used in SDC. To improve the computational efficiency, we will develop an adaptive approach to the SDC locally when and where it is needed.

We are developing and testing parallel-in-time algorithms for multiscale ordinary differential equations (ODE). We focus on the dissipative ODE systems. We find the parallel-in-time algorithm is effective in reducing the simulation time for this type of problem. We speed up the calculation by 10 times using 32 processors. We are developing a better scheme to reduce the communication costs between different processors.

Our techniques to dusty proto-planetary disk simulations were applied to study the asymmetry formation. Several large-scale asymmetric features have been observed in extrasolar planetary disks by the high-resolution ALMA telescope. Using our super-fast numerical tool, we have performed the longest and largest simulations to study the asymmetry formation. We have simulated how these asymmetric features are being formed and how long they can be sustained. Our numerical results compared quite well with the observation.

There are three papers published, three under preparation, and four invited talks related to this project.

Future Work

- Develop a new reduced order model (ROM) for the coupled dust-gas fluids using a unified approach, compare it with the old one for improvement.

- Develop and test parallel in time algorithm for multiscale partial differential equations. We will use the ROM as the coarser integrator to predict the value for the fine integrator, and using parallel-in-time to speed up the finer integrator.
- Develop a new algorithm to combine the spectral deferred correction (SDC) algorithm with our second-order operator-splitting approach to improve the accuracy.
- Apply the new algorithm to the dusty disk simulations with multiple dust species, implement new dust dynamic algorithm to handle dust coagulation and fragmentation, compare the simulation results with the observations.

Conclusion

The primary goal of this project is to develop an innovative numerical framework to accelerate the time integration for the multiscale problems. By using reduced order model and parallel in time strategy, we expect to speed up our current simulation of planet formation in dusty disks by at least two order of magnitude. Our proposed space-time parallelism can also solve spatial parallelization saturation issue: using more processors above a critical number will slow down the simulation due to the communication overhead. Our proposed algorithm can be easily applied to other multiscale problems to accelerate the simulation by orders of magnitude.

Publications

- Fu, W., H. Li, S. Li, and S. Lubow. Effects of dust feedback on vortices in protoplanetary disks . To appear in *Astrophysical Journal Letter*.
- Fu, W., H. Li, S. Lubow, and S. Li. LONG-TERM EVOLUTION OF PLANET-INDUCED VORTICES IN PROTOPLANETARY DISKS . 2014. *The Astrophysical Journal Letters*. 788 (2): L41.
- Guan, X., H. Li, and S. Li. Relativistic MHD Simulations of Poynting Flux-Driven Jets . 2013. *The Astrophysical Journal* 12/2013; 781(1). . 781 (1): 1.
- Li, S., and H. Li. 3D Simulations for Type-I Migration in Nearly Laminar Disks. To appear in *Numerical treatment of dust diffusion in dusty proto-planetary disks*. (Long island, CA, 16-20 Jun 2014).
- Zhai, X., H. Li, P. Bellen, and S. Li. Three-Dimensional MHD Simulation of Caltech Plasma Jet Experiment: First Results . 2014. *The Astrophysical Journal* . 791 (1): 1.
- Zhang, X., H. Li, S. Li, and D. Lin. RESONANCES OF MULTIPLE EXOPLANETS AND IMPLICATIONS FOR THEIR FORMATION . 2014. *The Astrophysical Journal Letters* . 789 (1): L23.

Automated Identification and Reverse Engineering of Malware

Curtis B. Storlie
20140355ER

Introduction

Malware (i.e., malicious program) analysis is a multi-Billion dollar industry. Beyond that, malware analysis is critical to our national security both to protect national secrets and to prevent corporate espionage. Almost all large government facilities and corporations employ trained cyber professionals to reverse engineer (RE) suspected malware so that they can respond appropriately. A highly trained professional can spend days to weeks uncovering the purpose of the malware, in an effort to discover who sent it, and the extent of the attack. An organization cannot adequately respond to a malware infection until they understand what it does.

The main goal of this project is to develop an automated framework for the reverse engineering of malware. We propose to develop a procedure that will take a program trace (static or dynamic), and classify the subroutines as a particular functionality (e.g., disk I/O, network, GUI, registry, exploit, etc). The results will be a list of likely classifications of a subroutine's functionality, with corresponding probabilities. This is precisely what a reverse engineer would do in a more qualitative manner when they are unraveling the purpose of a program. However, classifying subroutines manually is an incredibly time consuming task. Thus, this work will substantially speed up RE times, providing a swifter response and thus reducing the expense and possibly the severity of a malware infection.

A second important consequence of this work is that the task classification results can be used to automatically assess the high-level functionality of a program as a whole with far more accuracy than in previous work (i.e., trojan, adware, IRC, advanced persistent threat, etc.). There has been no attempt until now to automatically arrange and classify the various tasks of a program, hence, the potential for a large impact due to this work.

Benefit to National Security Missions

Malware analysis is a multi-Billion dollar industry. Beyond that malware analysis is critical to our national security both to protect national secrets and to prevent corporate espionage. Almost all large government facilities and corporations employ trained cyber professionals to reverse engineer suspected malware. This work will allow them to not only investigate more of the large amount of suspected malware discovered on their systems, but also allow a swifter response to these threats. The preliminary classification work is already mature enough to be implemented on any enterprise network just as it already has been at LANL in Code Vision. We intend to ultimately implement the new reverse engineering methodology developed in this work in a tool suitable for use by cyber professionals. This will allow the methodology to be transitioned into practice at other government agencies and corporations.

Progress

We obtained ~200 labeled subroutines from a few different families of Advanced persistent threat (APT) malware (i.e., the kind that we at LANL in particular are very interested in reverse engineering). We plan to have obtained ~500 by the end of the fiscal year.

We developed and assessed the performance of several approaches to subroutine classification into (currently) six categories of functionality (file I/O, network, GUI, exploit, process, registry). We investigated a sequence alignment approach (borrowed from methods in genetics) to develop a similarity score for subroutines. We also used the API calls made within a subroutine in addition to opcode sequences to aid in the classification of a subroutine. Finally, we incorporated the information of neighboring subroutines for classification of a given subroutine.

We are developing overall program similarity metrics

based on subroutines for the purpose of both (i) overall program classification and (ii) to pull up a previous program(s) that is very similar to the current one for RE purposes. For overall program classification, we are considering not only whether a program is malware or not, but we are working on classifying its behavior (e.g., Trojan, Adware, IRC, APT,...).

We have developed a GUI tool that will lay out the flow graph of a program and classify the subroutines into their functionality class(es). It will also show the subroutine trace and allow the user to link to any calls to other subroutines. We are working on the ability to bring up a very similar subroutine(s) from a previously analyzed, similar program(s). All of our ideas are discussed with our colleague in C-Sirt

Some of this initial work was presented at the Conference on Data Analysis in Santa Fe on March 6, 2014. The most recent approaches and results are being presented at the Malware Technical Exchange meeting at the Airforce Research Laboratory on July 22. Two papers are also in preparation.

Future Work

We will continue to obtain more labeled subroutine data from more malware families. We expect this process to be expedited due to our initial work and GUI tool. We also intend to further develop and refine our methodology to subroutine classification, possibly with something along the lines of a Markov model view of the subroutine class in a flow graph. We will finish developing the overall program similarity metrics based on subroutine and flow graph similarity for the purpose of both (i) overall program classification and (ii) to pull up a previous program(s) that is very similar to the current one for RE purposes. For overall program classification, we intend to classify not only whether a program is malware or not, but more precisely the type of malware (e.g., Trojan, adware, IRC, advanced persistent threat,...). Continue to improve the GUI tool for reverse engineering, including the ability to bring up previous analyzed programs and corresponding subroutines. We may also consider the problem of automatically identifying specific tasks inside of a program (e.g., a key logger that may be composed of several subroutines). We will finish the papers in development and start writing up the new results described above for scholarly journals. We will also continue to present this work at professional meetings.

Conclusion

We expect the work to result in a transformational ap-

proach to the reverse engineering of malware. We expect to understand the limits of the methodology in terms of how well it can provide likely purposes of each subroutine and program. We will validate the classification out-of-sample to ensure good performance. We further expect the subroutine classification results to provide extremely informative features for an overall program classification (benign, trojan, adware, IRC, advanced persistent threat,...) routine. This overall classification routine will also be thoroughly validated on a large dataset.

Publications

- Anderson, B., C. Storlie, M. Yates, and A. McPhall. Automating Reverse Engineering with Machine Learning Techniques. To appear in The 7th ACM Workshop on Security and Artificial Intelligence. (Scottsdale, 7 Nov. 2014).
- Anderson, B., T. Lane, and C. Hash. Malware Phylogenetics Based on the Multiview Graphical Lasso. To appear in The Thirteenth International Symposium on Intelligent Data Analysis. (Leuven, Belgium, 29-31 Oct. 2014).
- Kao, Y., B. Reich, C. Storlie, and B. Anderson. Malware Detection Using Nonparametric Bayesian Clustering and Classification Techniques. To appear in Technometrics.
- Storlie, C., B. Anderson, S. Vander Wiel, D. Quist, C. Hash, and N. Brown. Stochastic Identification of Malware with Dynamic Traces. 2014. *Annals of Applied Statistics*. 8 (1): 1.

Temporal Graphs

Aric A. Hagberg
20140389ER

Introduction

Graphs are increasingly being used to model complex techno-social networks such as the power grid, the internet, as well as computer and social networks. Understanding how these networks function and behave under changing circumstances is vital to several areas of national security.

This project will focus on developing temporal graph models for certain classes of complex networks such as computer and social networks. The scientific research will elucidate the interplay between the structural evolution of the network, temporal properties of the network, and dynamic processes, such as the spread of a virus or information, occurring on the network. The research will examine how sensitive networks are to perturbation, how to slow the speed of a virus and how to increase cybersecurity in the face of persistent attacks. We will develop efficient algorithms to generate random instances of these models as well as algorithms to fit data to the models. This project develops methods and techniques for network science. Network science is one of three cross-cutting themes in the Integrating Information, Science, and Technology for Prediction pillar at Los Alamos.

Benefit to National Security Missions

Network science is one of three cross-cutting themes in the Integrating Information, Science, and Technology for Prediction pillar at Los Alamos. Our work develops new models, techniques and theorems for dynamically changing graphs which are the underpinnings for many applications of network science. For example temporal graphs are a major research interest in cybersecurity and fill a missing gap in random graph models. Progress in modeling temporal graphs will provide capability relevant to DOD missions in cybersecurity anomaly detection.

The DOE ASC program sponsors research in the area of

complex networks related to big data challenges. Our research develops new algorithms to efficiently generate large instances of random graphs for modeling and testing of high-performance computing applications.

Progress

We developed a new modeling approach using random intersection graphs to capture the structure of computer authentication events. Authentication events imply relationships between computers and users, which can be represented as a bipartite graph. We used this graph to study the potential risk of credential hopping opportunities and to analyze potential mitigation strategies. Using graph-theoretical results for component sizes in random intersections graphs, we proposed two mitigation strategies, and performed experiments simulating their implementation. The results lead to realistic, actionable risk reduction strategies. We submitted the results as a paper to the international Internet Measurement Conference to be held in November 2014.

We invented a fast algorithm for generating large-scale random kernel graphs. The random kernel model is a general model that can be designed to capture perceived important characteristics of real networks and are mathematically tractable. For practical use in simulation, large instances of graphs need to be generated and the naive algorithm, which takes quadratic time in the number of nodes, does not scale favorably. As real world networks are usually sparse and large, it is important for the running time of generation algorithms to scale linearly in the number of edges. We proved our algorithm scales linearly in the number of edges and demonstrated the performance with a software implementation. Further we have developed a way to modify a given kernel in the model that can change the assortativity, an important network property. This work is being prepared for publication in the journal "Complex Networks".

We began investigating which metric for connectivity in temporal graphs is relevant for real systems such as the authentication event data. For static graphs the connectivity of a node has a single simple definition of the set of other nodes that you can reach by crossing links. For temporal graphs there are many possible definitions of “reachability” and it is time dependent. We are developing theorems for a definition in random temporal graphs related to how long you must wait to expect to be able to reach a given set of nodes.

Future Work

For FY15 we will continue with our goals of constructing temporal model of the expected degree graph and random intersection graphs. For those models we will seek theorems for connectivity and reachability. We will analyze SIR epidemic model on temporal random intersection graphs. We will develop models and inference methods to fit cyber authentication network data. Our results will be published in leading journals and top conferences in mathematics, statistics and cybersecurity. The algorithms for generating models will be tested and published in the NetworkX Python software package.

Conclusion

We target a fundamental challenge in network science, namely modeling the time-dependent changes in complex networks. Networks targeted in this work are cyber and social networks. We anticipate that this project will have a broad impact in the network science communities: we will contribute new insights and basic methodologies for understanding network evolution affects both the network topology, and those dynamical processes occurring on the network.

Publications

Hagberg, Aric, Alex Kent, Nathan Lemons, and Joshua Neil. Credential hopping in authentication graphs. To appear in Computational Social Networks (Complex Networks 2014).

Hagberg, Aric, and Nathan Lemons. Fast generation of inhomogeneous random graphs. To appear in Journal of Complex Networks.

Efficient Method for Large Scale Simulations of Fermionic Gases Interacting with Classical Fields

Cristian D. Batista
20140458ER

Introduction

We will develop a tool to simulate a broad range of quantum mechanical phenomena that arise from strongly correlated electrons in actinide, lanthanide, and transition metal based compounds. These compounds are of special interest due to the formation of meso-scale super-structures that produce novel macroscopic functionality. Interacting quantum mechanical systems are notoriously difficult to simulate; existing numerical methods cannot span the gap between atomic and mesoscale. Our new algorithm improves state of the art efficiency by orders of magnitude and makes the meso-scale accessible.

It applies to condensed matter systems of electrons interacting with a classical field that might represent local magnetic moments, charge density or a superconducting order parameter. We focus on the Kondo lattice model (KLM), where itinerant electrons interact with localized classical magnetic moments. Over the past decade, the KLM has been widely used to study giant and colossal magneto-resistance. In recent years, KLM studies have focused on a variety of new phases that have special transport properties. These new phases arise due to the complicated, effective many-body interactions of the classical field, obtained by “integrating out” the conduction electrons. Because electrons are quantum mechanical in nature, tracking the effective interactions for an evolving classical field requires repeated diagonalization of an $N \times N$ matrix, where N is the number of atoms in a finite lattice. A direct approach fails for lattices beyond $N=400$ lattice atoms. In our algorithm, the computational cost scales linearly with system size and preliminary studies of a triangular lattice of $N=40,000$ atoms lead to a variety of phenomena consistent with experiments: chiral vortices and domains, skyrmions, bound hedgehog dipoles, and interacting vortices. We will extend our method to study a broad variety of 2D and 3D models relevant to real materials and implement a version optimized for parallel execution.

Benefit to National Security Missions

We will develop a tool that will create fundamentally new capabilities for bridging two LANL grand challenges: “Information, Science and Technology” (IS&T) and “Materials: Discovery Science to Strategic Applications” (MDSSA). This research is a direct response to FY13 IS&T Grand Challenge priorities: development of methods for inference and prediction of large-scale complex systems and design of algorithms to efficiently extract information from massive amounts of data. Our project also responds specifically to the LDRD “Materials for the Future” focused area and addresses the priorities of realizing design principles towards controlled functionality and developing multifunctional materials to transform structural and functional performance and integration, and tunable and emergent properties. In the BES report on Basic Research Needs, multifunctional materials are emphasized as solutions to a range of energy problems. The main bottleneck for understanding the complex behavior of interacting quantum systems is the lack of efficient algorithms for simulating the corresponding models. Developing this capability is crucial for addressing future Laboratory mission challenges such as inference and prediction of large-scale complex systems, and prediction and control of emergent phenomena in complex materials. The innovative codes that will be developed under this project will be applied to the simulation of real compounds that are being investigated in our experimental groups. These codes will support new program developments for modeling and simulating complex materials. This challenging task will have a major worldwide impact on the fundamental understanding of unconventional states of matter. Such states have great application potential due to their unusual physical responses.

Progress

We extended our code to study the KLM for other lattice types. In the square lattice case, we investigated the

effect of competing next-nearest neighbor interactions, which give rise to skyrmion orderings of tunable length scales. The competition mechanism is slightly different (more robust) than that reported in D. Solenov, D. Mozyrsky, and I. Martin. Chirality waves in two-dimensional magnets. *Phys. Rev. Lett.*, 108, 096403 (2012). In particular, we do not rely on weak effects at the bottom of a perfectly quadratic Fermi surface, which would be disrupted by any lattice anisotropy. We have transferred this project, and methodological expertise, to our external collaborator Yoshitomo Kamiya.

Our method has proven very successful for the Kagome KLM. We have verified several theoretically predicted spin orderings, and have also discovered new ones that were not previously considered. We are almost ready to submit a draft of this work to *Phys. Rev. X*.

We have had several breakthroughs that enabled us to generalize our methods to the study of tight-binding molecular dynamics. This work was motivated by our new colleagues in chemical physics such as Joel Kress, Art Voter, and Anders Niklasson (T-1), the author of the Latte code. From discussions with these experts, we believe can extend our algorithm to enable the first $O(n)$ scaling quantum MD code of metals. To reach this point, we had to overcome several obstacles:

- Most quantum-MD simulations are run at constant electron number N_e , rather than constant electronic chemical potential μ . Unfortunately, the Kernel Polynomial Method is restricted to constant μ . We have found a clever thermodynamic change of variables to express the force at constant N_e via the grand canonical potential Φ , which KPM is able to calculate efficiently.
- In our initial work on the KLM, we applied the over-damped limit of Langevin dynamics to minimize the statistical error introduced by stochastic estimates of the force. In MD, non-equilibrium dynamics is of central interest, and over-damped dynamics is not appropriate. However, when a strong inertial term is re-introduced to the dynamical equations, the accuracy of stochastic force estimates becomes a severe constraint. The cost of our algorithms scales linearly with s , the number of random vectors, while the Langevin damping time scale γ grows like s . We have discovered a little-known algorithmic technique that uses correlated random vectors to greatly decrease γ and total computational cost (C. Bekas, E. Kokiopoulou, and Y. Saad. An estimator for the diagonal of a matrix. 57, 1214–1229, (2007). However, the application of this ‘correlated vector’ technique to MD

(in which atoms move off lattice) requires us to solve a difficult graph coloring problem. Work is underway to implement this graph-coloring subroutine, with help from a summer student, Julien Roussel.

- In our initial investigations of tight-binding MD, we have simulated melting with many thousands of silicon and aluminum atoms. These large-scale tight-binding simulations of a metal phase are unprecedented. To reach tens or hundreds of thousands of atoms, we have begun writing a truly high-performance C++/MPI version of our code, which will expect to scale to hundreds of GPUs. Our KPM algorithm benefits from “embarrassing” parallelization, in which the force contribution from each stochastic vector may be separately calculated.

Future Work

- We will develop a truly high-performance C++/MPI version of our code, which will be scaled to hundreds of GPUs in order to reach tens or hundreds of thousands of atoms.
- We will use the code developed in 1. to simulate the propagation of topological defects in atomic crystals.
- We will start simulations of Kondo Lattice Models (KLM) with small Fermi surface pockets. This is a pre-condition for stabilizing the desired emergent meso-scale structures.

Conclusion

The algorithm and codes to be developed in this project will allow us to study phases that were previously inaccessible. We will study the emergence of complex meso-scale magnetic patterns that we know should occur in low-density electron gases interacting with magnetic ions. Our codes will include a tool for incorporating the band structure parameters of the itinerant electrons which are computed via a tight-binding parameterization of the conduction bands obtained from first principle calculations [Local Density Approximation (LDA)]. We will deliver a high-performance implementation of our algorithm, and many associated analysis tools, to the LANL community.

Publications

Barros, , Sinkovits, and Luijten. Efficient and accurate simulation of dynamic dielectric objects. 2014. *JOURNAL OF CHEMICAL PHYSICS*. 140 (6).

Barros, K., F. Venderbos, G. Chern, and C. D. Batista. Novel magnetic orderings in the kagome Kondo-lattice model. *Physical Review B*.

Barros, K., and E. Luijten. Dielectric Effects in the Self-Assembly of Binary Colloidal Aggregates. 2014. *Physical*

Review Letters. 113: 017801.

Lin, , C. D. Batista, Reichhardt, and Saxena. ac Current Generation in Chiral Magnetic Insulators and Skyrmion Motion induced by the Spin Seebeck Effect. 2014. PHYSICAL REVIEW LETTERS. 112 (18).

Lin, , C. D. Batista, and Saxena. Internal modes of a skyrmion in the ferromagnetic state of chiral magnets. 2014. PHYSICAL REVIEW B. 89 (2).

Lin, S., C. Reichhardt, C. D. Batista, and A. Saxena. Dynamics of skyrmions in chiral magnets: dynamic phase transitions and equation of motion. 2014. Journal of Applied Physics. 115: 17D109.

Lin, S., X. Wang, Y. Kamiya, G. Chern, F. Fan, D. Fan, B. Casas, Y. Liu, V. Kiryukhin , W. Zurek, C. D. Batista, and S. Cheong. Topological defects as relics of emergent continuous symmetry and Higgs condensation of disorder in ferroelectrics. To appear in Nature Physics.

Integrated Photonics Pathfinder (IPP)

Kevin P. McCabe
20140507ER

Introduction

Single-photon, quantum communications (QC) offers “future proof”, lightweight cyber security solutions for networks. This work will harness emerging Si integrated electro-photonics to reduce QC size and cost by 100x each, and improve controllable attenuation by 4 orders of magnitude. We will design, fab and test photonic die to validate performance models of optical components necessary for the coexistence of quantum communications (QC) with conventional optical network communications. While LANL has demonstrated QC using modular integrated photonics, QC has never before been performed with monolithically integrated photonics, a gateway to advanced quantum optical systems for research in such areas as optical quantum computing. LANL has world-class expertise and an extensive portfolio of intellectual property in QC that will enable application of this advanced technology to global security missions. In addition to QC as an application domain with particular value for securing critical infrastructure, complex systems enabled by miniaturization and integration of optics with electronics, with sensitive and selective detectors will lead to new possibilities in the science of signatures and advances in forward deployment of imaging sensors.

Benefit to National Security Missions

Quantum communications will address long-duration/high-value security needs within many network environments, such as: certain DoD and DOE complexes; between government agencies in the Washington, DC area; financial networks; supervisory, control and data acquisition (SCADA) systems for critical infrastructure (power, water and SmartGrid) networks; LANL's own network or within a US Embassy compound. Further applications will extend security to constrained network environments. Examples include: warhead verification and IAEA treaty monitoring. Miniaturized QC systems will enable a hand-held quantum secured device to be used for identification, authentication, access control and secure

telephone calls. An aircraft or satellite acting as a trusted node could establish ad hoc secure networks of ground, sea and air-based users on a continental or even a global scale. Silicon photonics built with electronics on the same substrate will also produce new capabilities for LDRD research in improved optical and particle sensors. Integrated sensors and electronics have been shown to provide the highest S/N performance / highest sensitivity / fastest detectors ever built.

Progress

With the optical modeling tools we acquired in our FY13 LDRD ER Reserve project we designed test structures and modeled performance parameters. We pursued wafer fabrication with OpSIS, a provider of research scale multi-project silicon wafer runs. We had issues with the NDA that were not resolved due to legal exceptions to the T&Cs. OpSIS recently announced that they were dissolving after the next wafer run. We have pursued multiple alternate sources including SUNY which has arguably the nations most capable research foundry but the cost of \$300K for a large complete wafer was outside the scope of the ER. Through interactions at the OFC conference we began discussions with Acacia Communications Inc., a market leader in 100G ultra high speed optical communications with extensive experience in some of the polarization control issues we need to address. Under NDA 14-0132, we disclosed sufficient information their chief designer to develop optical test structures to achieve our research goals. The designs were taped out in May for immediate fabrication and subsequent testing at LANL. Through this interaction we are achieving our technical goals ahead of schedule while potentially achieving a significant programmatic goal of engaging a commercial collaborator with the means to fabricate our designs.

Future Work

Goal: Develop integrated photonic capability through

multiple design/fab and test iterations. At this time the first fabrication cycle is complete via a collaboration with

Tasks

- Test first and second fabrications of integrated photonic chip
- Develop automated test fixture to probe bare photonic chips
- Design second iteration of photonic chip

Goal

Develop a device to advance TRL and technology transfer opportunities of quantum communications:

- Develop collaborative research relationships with US photonic foundries and related research institutions.
- With Tech Transfer/Feynman Center continue to develop opportunities for quantum communications that will inform design specification and tradeoffs of the photonics chip

Conclusion

We will develop a pathfinder design of optical components, fabricate a small number of die, and bond them to a substrate and test the bare die with an inexpensive optical set. There will be at least two iterations of prototype parts in a rapid technology development spiral suitable for the relative immaturity of the technology. The overall technical goal is a photonic device that is the core technology of network-centric quantum communications.

Uncertainty Quantification for Networks

Earl C. Lawrence
20120123ER

Abstract

Networks deliver many important commodities, such as energy and information, making them a core element of the infrastructure for national and global security, as well as everyday life. Unfortunately, the networks themselves are complex, vulnerable, unpredictable, and only partially observable. Despite incomplete knowledge, analysts must make decisions about network resiliency and criticality. Currently these decisions are based on predictions of the complete network based on expert judgment or basic state estimation techniques. This proposal addresses the challenge of uncertainty quantification (UQ) for networks based on partial observation of the topology, attributes, and flows. Specifically, we will develop methodology for inference about unobserved parts of a network, such as links, nodes, attributes, and commodity flows, using science-based simulation tools in conjunction with the observed network components. We propose a new Bayesian methodology for estimation and UQ for unobserved network components using simulation tools. There are already well-developed methods for UQ that combine simulations and physical observations (e.g., for nuclear weapon performance) to estimate unknown parameters and make predictions about processes that operate on compact spaces, but these cannot be easily extended to network models with graph inputs. Additionally, there are methods for estimating the topologies of graphs, including in infrastructure domains, but these generally consider fairly simple scenarios and they do not integrate science-based simulation models. Ideas from both areas of research need to be combined and extended in order to meet the new challenges presented in the network domain. The proposed work will be developed in the context of electric power. The major challenges are specifying the prior distribution and likelihood that comprise the posterior distribution of an infrastructure network and exploring the space of plausible networks that fill out the unobserved components. Prior specification is important for capturing constraints such as cost and engineering fea-

sibility. The prior and the likelihood need to accurately reflect scientific understanding and measurement ability, while remaining computationally tractable. Once they have been specified, methods are needed to explore tenable solutions by proposing and moving between high probability graphs in an efficient manner. The result will be computationally efficient methods for network uncertainty modeling. These methods will leverage previously unusable data, expertise, and predictive science capabilities to address strategic needs for both LANL and DHS stakeholders. The project has delivered on its goal of developing methodology for estimating unknown power grid elements (faults, loads, injections, topology errors).

Background and Research Objectives

The project's goal was to develop statistical methodology for estimating unobserved parts of a network and providing uncertainty about the estimate. The work focused on developing methodology for power grids. In this context, unobserved network components could include downed lines and other faults, demands, injections, and flows. A key feature of the work was to include physics-based simulations of electric power networks as part of the estimation methodology.

Scientific Approach and Accomplishments

Our general scientific approach was to incorporate simulators of both static and dynamic electric power grids into a Bayesian statistical framework. In general, we sought to make use of these, sometimes computationally intensive, simulations in an efficient manner. In some cases, the simulations were run offline in order to build a statistical approximation that could be used in a real-time setting. In other cases, they were run in carefully selected ways as part of filtering scheme. In all cases, a statistical model was built around the simulator in order to give predictions under various possible topology changes or faults. These predictions could be compared with data in order to decide if and where a

fault has occurred.

The final results of our work are methods for detecting and classifying changes in power grids using data from phasor measurements. The detection is based on the extended Kalman filter. This method makes predictions based on physical system dynamics about the data we expect to collect in the next fraction of a second. If those data differ by too much from our prediction (in a probabilistic sense), we determine that some fault or change has occurred. The classification method uses phasor data from the fraction of a second after a change is detected to estimate probabilities for a pre-selected bank of possible faults that are of particular importance to the grid operators. The classification scheme is trained using physics-based simulations. We have also developed classification methods using legacy power grid data.

Because all of these methods are probabilistic, they inherently quantify our uncertainty about any decision. The fault detection methodology essentially reports the probability that a fault has occurred at any time step. The classification methodology may report a small set of possible contingencies that have non-negligible probabilities. This prevents us from too confident about our predictions. This also motivated our work on chance-constrained optimization that accounts for these uncertainties when making control decisions about generator operation.

Over the course of the project, we have submitted or published four papers, with three additional papers nearing completion with students. Further, we have given several invited presentations at both statistics and power engineering conferences. Over three summers, the project employed four students, at least three of whom are interested in further employment at LANL (one will be starting an unrelated post-doc later this fall).

Impact on National Missions

This research will impact LANL programs in Global Security (PADGS) and Computer, Computational, and Statistics (CCS) Sciences and the missions of the Energy Security Institute and the Information Science and Technology Institute. PADGS will benefit from validated, science-based methodologies that estimate unobserved network features with known confidence as many problems in homeland security and intelligence are otherwise. The core information science is also applicable to a wide variety of network domains including cyber, supply chains, natural gas, water, and oil, as well as social and biological networks. Possible applications include criticality, impact analysis, state estimation, event detection, effects-based operations, situational awareness after a disaster, cost estimation, and climate impact in future networks; influences between

interconnected networks; and targeted data collection for uncertainty reduction. The results of the work could ultimately contribute to the development of safer, more efficient, more robust, and more reliable energy infrastructure.

Publications

- Bent, R., D. Bienstock, E. Chertkov, E. Lawrence, and S. Vander Wiel. Chance constrained optimal power flow for topology uncertainty. Invited presentation at INFORMS Annual Meeting 2013. (Minneapolis, 6-9 Oct. 2013).
- Bent, R., D. Bienstock, E. Chertkov, E. Lawrence, and S. Vander Wiel. Risk Constrained Optimal Power Flow for Topology Uncertainty. To appear in IEEE Transactions on Power Systems.
- Garcia, M., A. Giani, and K. Poolla. Partial state estimation for Electricity Grids. 2013. In 52nd IEEE Conference on Decision and Control. (Florence, Italy, 10-13 Dec. 2013). , p. 7016. Firenze: IEEE.
- Lawrence, E., S. Vander Wiel, and R. Bent. Model bank state estimation for power grids using importance sampling. 2013. *Technometrics*. 55 (4): ?.
- Wiel, S. Vander, E. Lawrence, and R. Bent. Uncertainty quantification for networks with power distribution applications. Invited presentation at Conference on Data Analysis. (Santa Fe NM, 29 Feb - 2 Mar 2012).
- Wiel, S. Vander, E. Lawrence, and R. Bent. Uncertainty quantification for power networks. Presented at Optimization and Control for Smart Grids. (Santa Fe NM, 21-25 May 2012).
- Wiel, S. Vander, R. Bent, E. Casleton, and E. Lawrence. Identification of Topology Changes in Power Grids using Phasor Measurements. To appear in Applied Stochastic Models in Business and Industry.
- Wiel, S. Vander, R. Bent, E. Lawrence, and E. Casleton. Uncertainty quantification for networks with power distribution applications. Invited presentation at Quality and Productivity Research Conference 2013. (Niskayuna, NY, 5-7 June 2013).

Non-Equilibrium Fluctuation-Induced Interactions

Diego A. Dalvit
20120149ER

Abstract

The goal of the project was to explore the non-equilibrium aspects of electromagnetic fluctuation-induced interactions. To this end we carried out a concerted theoretical and experimental effort to investigate quantum and thermal fluctuation-induced electromagnetic interactions at the nano-scale, using state-of-the-art analytical, numerical, nanofabrication, and measurement tools. We formulated the first principles, microscopic theory of non-equilibrium fluctuation-induced interactions using the open quantum systems paradigm, and developed numerical tools to simulate complex nanostructures out of dynamic and/or thermal equilibrium. The predictive framework and experimental capabilities that we developed have helped advance the state-of-the-art of our understanding of fluctuation-induced interactions, both in equilibrium settings as well as in mechanical and thermal non-equilibrium configurations.

Background and Research Objectives

Fluctuation-induced interactions are ubiquitous in physics. Relevant examples are forces between nanostructures due to quantum fluctuations of the electromagnetic field (EM Casimir interactions), and forces on colloidal particles due to density fluctuations of binary fluid mixtures (critical Casimir interactions). Although much of the equilibrium aspects of these interactions are understood and confirmed by experiment, non-equilibrium is still an open territory. The goal of this proposal was to carry out a concerted theoretical and experimental effort to investigate fluctuation-induced electromagnetic interactions at the nano-scale, using state-of-the-art analytical, numerical, nanofabrication, and measurement tools. Our main research objective was the understanding of, and ultimately control over fluctuation-induced interactions in equilibrium as well as in dynamical and thermal non-equilibrium systems, such as: (i) strong reduction of equilibrium Casimir interactions through metallic surface nanostructuring, which can potentially solve the issue of stiction in nanomachines; (ii) non-contact forces and fric-

tion between surfaces and atoms in relative motion, induced by quantum EM fluctuations; and (iii) nano-scale radiative heat transfer between complex nanostructures, induced by thermal EM fluctuations. We formulated the first principles, microscopic theory of non-equilibrium EM fluctuation interactions using the open quantum systems paradigm, and developed numerical methods to compute them exactly for complex nanostructures out of dynamic and/or thermal equilibrium

Scientific Approach and Accomplishments

We developed a comprehensive theory for quantum vacuum electromagnetic drag, also known as “quantum friction.” We derived the zero-temperature frictional force using a non-equilibrium fluctuation-dissipation relation, and showed that in the large-time, steady-state regime quantum friction scales as the cubic power of the atom’s velocity. We also investigated other approximate approaches, such as the Wigner-Weisskopf and quantum regression approximations, typically used in quantum optics, to compute quantum friction, and showed how these approaches fail to predict the correct steady-state zero temperature frictional force, mainly due to the low frequency nature of quantum friction. The results of this work were published [1], “Quantum friction and fluctuation theorems”, F. Intravaia, R.O. Behunin, and D.A.R. Dalvit, *Phys. Rev. A* 89 050101(R) (2014). We are currently writing two follow-up papers on the topic, one containing extensive details of the calculations of [1], and another one on an alternative approach to quantum friction based on time-dependent perturbation theory. Furthermore, the PI of the project gave several talks at international conferences, including an invited talk at the XXIII Interactional Materials Research Congress in Cancun, Mexico (2014), and another invited talk at PIERS 13 in Stockholm, Sweden (2013).

We also developed theory and simulations for enhanced radiative heat transfer between metallic nanostructured surfaces. Using techniques of numerical electromag-

netism, in particular rigorous coupled waves approached (RCWA), the reflection matrices of 1D lamellar gratings were computed and used in the evaluation of the near-field radiative heat transfer. The modeling shows that by changing the depth of the corrugations of the gratings, it is possible to engineer the electromagnetic mode structure within the cavity formed by two opposing gratings, and thereby create new “channels” for energy radiative transmission. This work was published [2, 3], “Enhanced radiative heat transfer between nanostructured gold plates”, R. Guerout, J. Lussange, F.S.S. Rosa, J.-P. Hugonin, D.A.R. Dalvit, J.-J. Greffet, A. Lambrecht, and S. Reynaud, *Phys. Rev. B* 85, 180301(R) (2012), and in *J. Phys.: Conference Series* 395, 012154 (2012). We are currently working on another theory paper on near-field radiative heat transfer with novel two dimensional materials, including topological and Chern insulators (to be published). On the experimental side, we fabricated several metallic nanogratings for heat transfer using different methods, including ICP and RIE etching. The typical period is 1 micron, corrugation depths of 2 microns, and 0.5 filling factor. We also developed recipes for high aspect ratio (>10) grating fabrication which will be generally applicable to other nanoscale researches. The experimental set-up for measuring near-field radiative heat transfer consists of an ultrahigh vacuum atomic force microscope (AFM) with variable sample temperature capability to measure heat transfer efficiency between the AFM tip and another surface as a function of the tip-sample distance. In this approach, special tips are mounted to the cantilever and incorporate nanoscale resistive Pt thermometer at the very apex of the tip. During the experiment, the temperature of this nano-thermometer is modulated and measured at the modulation frequency as a function of the tip-sample distance to increase the sensitivity of the heat conductivity measurements. Although <10 mK accuracy was expected, the real noise level exceeded this value by more than an order of magnitude and prevents the detection of the heat transfer changes at the nanoWatts level. In order to circumvent this problem and achieve reliable observation of heat transfer variations at the nanoscale, we significantly modified the existing control electronics which then allowed operation of such a scanning thermal microscope in a non-contact mode. In this mode, the tip is oscillating above the surface at one frequency and the temperature of the tip is modulated at a different rate. Such a double-modulation geometry will ultimately allow to the nanoWatts territory and enable quantitative analysis of the tip-sample distance dependence of the near-field heat transfer from the nanostructured metal surfaces. Beside the studies of the thermal conductivity in the evanescent fields, this technique will also be applicable to a broad range of thermo-electric materials that represent one of the focus areas at CINT.

We have developed theory and simulation tools for Casimir force experiments involving metallic nanostructures, which resulted in the paper [4] “Quasi-analytical modal approach for computing Casimir interactions in periodic nanostructures”, F. Intravaia, P.S. Dalvids, R.S. Decca, V.A. Aksyuk, D. Lopez, and D.A.R. Dalvit, *Phys. Rev. A* 86, 042101 (2012). We then demonstrated that by nanostructuring one of the interacting metal surfaces at scales below the plasma wavelength, an unexpected regime in the Casimir force can be observed. Replacing a flat surface with a deep metallic lamellar grating with sub-100 nm features strongly suppresses the Casimir force and for large inter-surfaces separations reduces it beyond what would be naively expected. This was confirmed experimentally through a collaboration with Argonne National Laboratory, NIST, and Indiana University. This work was published [5], “Strong Casimir force reduction through metallic surface nanostructuring”, F. Intravaia, S. Koev, I. Jung, A. Talin, P. Davids, R.S. Decca, V.A. Aksyuk, D.A.R. Dalvit, and D. Lopez, *Nature Communications* 4, 2515 (2013). In addition, we have theoretically studied other situations in which equilibrium fluctuation-induced interactions are relevant, for example between bodies immersed in fluids. This work, in collaboration with MIT and Harvard researchers, was published [6], “Geometry-induced Casimir suspension of oblate bodies in fluids”, A.W. Rodriguez, M.T. Homer Reid, F. Intravaia, A. Woolf, D.A.R. Dalvit, F. Capasso, and S.G. Johnson, *Phys. Rev. Lett.* 111, 180402 (2013).

Finally, we have also developed modeling and simulation tools for studying one key systematic effect present in all measurements of electromagnetic fluctuation-induced interactions, namely electrostatic patch effects present in metallic samples. We have derived, for the first time, an exact analytical expression for patch force in the sphere-plane geometry, which resulted in the publication [7], “Electrostatic patch effects in Casimir force experiments performed in the sphere-plane geometry”, R.O. Behunin, Y. Zeng, D.A.R. Dalvit, and S. Reynaud, *Phys. Rev. A* 86, 052509 (2012). This work prompted another collaboration with Indiana University, Ecole Normale Supérieure and University of Strasbourg (France) to measure patch effects in metallic samples used in Casimir force measurements. This work is under review in *Phys. Rev. A* [8], “Kelvin probe force microscopy of metallic surfaces used in Casimir force measurements”, R.O. Behunin, D.A.R. Dalvit, R.S. Decca, C. Genet, I.W. Jung, A. Lambrecht, A. Liscio, D. Lopez, S. Reynaud, G. Schnoering, G. Voisin, and Y. Zeng, arXiv:1407.3741. In addition, we have also studied how patch effects pose limits on the accuracy of experiments trying to measure corrections to Newtonian gravity at sub-micrometer scales. This resulted in the publication [9], “Limits on the accuracy of isoelectronic gravity measurements at

short separation due to patch effects”, R.O. Behunin, D.A.R. Dalvit, R.S. Decca, and C.C. Speake, *Phys. Rev. D* 89, 051301 (R) (2014). Recently, we studied localized plasmon modes in Ag nanohemispheres in collaboration with Oklahoma State University and University of Massachusetts; and we are currently preparing a manuscript based on our theoretical and experimental results.

Impact on National Missions

Our R&D program ties to LANL missions on quantum science and nanotechnology. It leverages existing capabilities across the laboratory, both in the T and MPA divisions. The new ideas that we produced helped consolidate LANL as a world leader in fluctuation-induced interactions, as demonstrated by the number of invited and keynote talks given by the PI of the project. The new capabilities that we built, including analytical tools, numerical algorithms, nanofabricated surfaces, and scanning thermal microscopy techniques for engineered heat transfer, will enable LANL to pursue future missions in nanotechnology, nanophotonics, and quantum physics. Our work impacts the Lab’s Materials Grand Challenge, specifically LANL Materials Strategy on emergent phenomena at interfaces, since our project addressed a physical process that arises when dynamical interfaces modify the electromagnetic vacuum. Our work also strongly impacts LANL mission on nanotechnology and nanophotonics, especially since our proposed work on engineered heat transfer has potential technological applications to thermophotovoltaics. As Casimir interactions are intrinsic quantum phenomena, our project also impacts LANL mission on quantum science and technology.

References

1. Intravaia, F., R. O. Behunin, and D. A. R. Dalvit. Quantum friction and fluctuation theorems. 2014. *Physical Review A, Rapid Communications*. 89: 050101(R).
2. Guerout, R., J. Lussange, F. S. S. Rosa, J. -P. Hugonin, D. A. R. Dalvit, J. -J. Greffet, A. Lambrecht, and R. Reynaud. Enhanced radiative heat transfer between nanostructured gold plates. 2012. *Physical Review B, Rapid Communications*. 85: 180301(R).
3. Guerout, R., J. Lussange, F. S. S. Rosa, J. -P. Hugonin, D. A. R. Dalvit, J. -J. Greffet, A. Lambrecht, and S. Reynaud. Enhanced radiative heat transfer between nanostructured gold plates. 2012. *Journal of Physics: Conference Series* . 395: 012154.
4. Intravaia, F., P. S. Davids, V. A. Aksyuk, D. Lopez, R. S. Decca, and D. A. R. Dalvit. Quasi-analytical modal approach for computing Casimir interactions in periodic nanostructures. 2012. *Physical Review A*. 86: 042101.

5. Intravaia, F., S. Koev, I. Jung, A. Talin, P. Davids, R. S. Decca, V. A. Aksyuk, D. A. R. Dalvit, and D. Lopez. Strong Casimir force reduction through metallic surface nanostructuring. 2013. *Nature Communications*. 4: 2515.
6. Rodriguez, A. W., M. T. Homer Reid, F. Intravaia, A. Woolf, D. A. R. Dalvit, F. Capasso, and S. G. Johnson. Geometry-induced Casimir suspension of oblate bodies in fluids. 2013. *Physical Review Letters*. 111: 180402.
7. Behunin, R. O., Y. Zeng, D. A. R. Dalvit, and S. Reynaud. Electrostatic patch effects in Casimir force measurements performed in the sphere-plane geometry. 2012. *Physical Review A*. 86: 052509.
8. Behunin, R. O., D. A. R. Dalvit, R. S. Decca, C. Genet, I. W. Jung, A. Lambrecht, A. Liscio, D. Lopez, S. Reynaud, G. Schnoering, G. Voisin, and Y. Zeng. Kelvin probe force microscopy of metallic surfaces used in Casimir force measurements. *Physical Review A*.
9. Behunin, R. O., D. A. R. Dalvit, R. S. Decca, and C. C. Speake. Limits on the accuracy of isoelectronic gravity measurements at short separation due to patch effects. 2014. *Physical Review D, Rapid Communications*. 89: 051301(R).

Publications

- Behunin, R. O., D. A. R. Dalvit, R. S. Decca, C. Genet, I. W. Jung, A. Lambrecht, A. Liscio, D. Lopez, S. Reynaud, G. Schnoering, G. Voisin, and Y. Zeng. Kelvin probe force microscopy of metallic surfaces used in Casimir force measurements. *Physical Review A*.
- Behunin, R. O., F. Intravaia, D. A. Dalvit, P. A. Neto, and S. Reynaud. Modeling electrostatic patch effects in Casimir force measurements. 2012. *Physical Review A (Atomic, Molecular, and Optical Physics)*. 85 (1): 012504 (9 pp.).
- Behunin, R. O., Y. Zeng, D. A. R. Dalvit, and S. Reynaud. Electrostatic patch effects in Casimir force experiments performed in the sphere-plane geometry . 2012. *Physical Review A*. 86: 052509.
- Behunin, R., D. Dalvit, R. Decca, and C. Speake. Limits on the accuracy of isoelectronic gravity measurements at short separation due to patch effects. 2014. *Physical Review D, Rapid Communications*. 89: 051301(R).
- Guerout, R., J. Lussange, F. S. Rosa, J. -. Hugonin, D. A. Dalvit, J. -. Greffet, A. Lambrecht, and S. Reynaud. Enhanced radiative heat transfer between nanostructured gold plates. 2012. *PHYSICAL REVIEW B*. 85 (18): 180301.

-
- Guerout, R., J. Lussange, F. S. S. Rosa, J. -P. Hugonin, D. A. R. Dalvit, J. -J. Greffet, A. Lambrecht, and S. Reynaud. Enhanced radiative heat transfer between nanostructured gold plates. 2012. *Journal of Physics: Conference Series*. 395: 012154.
- Intravaia, F., P. S. Davids, R. S. Decca, V. A. Aksyuk, D. Lopez, and D. A. R. Dalvit. A quasi-analytical modal approach for computing Casimir interactions in periodic nanostructures . 2012. *Physical Review A*. 86: 042101.
- Intravaia, F., R. Behunin, and D. Dalvit. Quantum friction and fluctuation theorems. 2014. *Physical Review A, Rapid Communications*. 89: 050101(R).
- Intravaia, F., S. Koev, I. Jung, A. Talin, P. Davids, R. Decca, V. Aksyuk, D. Dalvit, and D. Lopez. Strong Casimir force reduction through metallic surface nanostructuring. 2013. *Nature Communications*. 4: 2515.
- Rodriguez, A., M. Homer Reid, A. Woolf, D. Dalvit, F. Capasso, S. Johnson, and F. Intravaia. Geometry-induced Casimir suspension of oblate bodies in fluids. 2013. *Physical Review Letters*. 111: 180402.
- Rosa, F. S., D. A. Dalvit, and P. W. Milonni. Electromagnetic energy, absorption, and Casimir forces. II. Inhomogeneous dielectric media. 2011. *PHYSICAL REVIEW A*. 84 (5): 053813.
- Sushkov, A. O., W. J. Kim, D. A. Dalvit, and S. K. Lamoreaux. New Experimental Limits on Non-Newtonian Forces in the Micrometer Range. 2011. *Physical Review Letters*. 107 (17): 171101 (4 pp.).

Monte Carlo for Quantum Transport

James E. Gubernatis
20120266ER

Abstract

We proposed to eliminate the computational bottleneck in the wavefunction Monte Carlo method to enable simulations of quantum transport in models of nanoscale devices. This method solves an equation of motion whose solution yields the same information as the solution of the computationally more expensive master equation for the density matrix. The solutions to either equation of motion share similar bottlenecks, and their use for simulations is limited to systems with relatively few atoms. We wanted to push the use of the wavefunction method to systems with more atoms. Specifically, for this method we sought to replace the exact execution of a matrix-vector multiplication bottleneck by a Monte Carlo estimate of this product by using non-local sampling techniques developed for the Monte Carlo simulation of finite-temperature quantum systems. These novel techniques would also eliminate the time discretization error in the solutions of the equations of motion. Our four main accomplishments were: (1) The discovery that the definition of current used in many published wavefunction Monte Carlo simulations was unphysical. We developed a proper definition. (2) The observation that the density matrices computed deterministically from the master equation and stochastically from the wavefunction Monte Carlo method differed. We traced its source of this discrepancy to the small values of the off-diagonal matrix elements that develop for a system with more than just a few atoms. The problem appears intrinsic to the computation of a density matrix. (3) The observation that the standard quantum information theory metrics for the closeness of two density matrices for gauging numerical accuracy were misleading. The standards for quantum information theory return information that is too global. A simple matrix root-mean-squared measure is more powerful. (4) We developed and implemented a new non-local continuous-time Monte Carlo solver for quantum dynamics.

Background and Research Objectives

In the past decade all nations with major economies have made huge investments in nanotechnology because nanofabricated materials can display properties that do not occur naturally but are needed for advanced technologies. Reducing the physical size of a material heightens the importance of quantum effects on its properties. Predicting and controlling these effects is the objective. In some cases, the downsizing of materials has exposed gaps in the available theoretical and experimental tools available. The ability to simulate quantum transport is one theoretical gap.

We targeted spin, charge, and energy transport in quantum-wire devices, such as rectifiers and transistors, and not only addressed the transport in the devices but also the transport through the leads connecting them to the environment that establish voltage and temperature gradients. Experimentally, nanometer-sized devices are being designed for such applications as light and heat harvesting, information storage, logic circuits, and advanced sensors.

We focused on extending a simulation method, the wavefunction Monte Carlo method, developed in quantum optics for different types of non-equilibrium applications. While we exploited several seminal insights developed in quantum optics, we sought to abandon the specific Monte Carlo strategy being used there. Our Monte Carlo replacement will produce a more flexible and a much more efficient computational tool. Demonstrating its efficiency for select applications would create a new subfield of quantum Monte Carlo.

Monte Carlo methods sample probability distribution functions. These functions must be positive. The problem with many quantum Monte Carlo methods is the function needing sampling is often not positive and in fact may be complex. A theorem [1] actually precludes the positivity of a joint distribution of position and mo-

mentum, which is at the core of the well-used Boltzmann transport equation. Accordingly, this common approach to studying transport can only treat a quantum problem semi-classically. On the other hand, quantum optics [2] has produced an approach to quantum non-equilibrium problems that guarantees the function needing sampling is positive. The present way the Monte Carlo method is being used to sample this function however has a cost that scales exponentially with the size of the system, making its use for larger non-quantum-optics problems quickly impractical. We proposed to change this and make the wavefunction Monte Carlo method very practical for larger systems.

Normally, in quantum mechanics, the wave function is the object of interest, but in non-equilibrium quantum mechanics the interest instead is on the density matrix. These objects satisfy different equations of motion that need a numerical solution to find the time evolution of each object. Generally a deterministic solution is found, meaning the method of solution lacks any stochastic processes. The methods advance the solution in time by a sequence of small finite time steps dt . Operationally, the wave function is described by a list of N numbers, called a vector, while the density matrix by an array of N times N numbers, called a matrix. Accordingly, the density matrix is more costly to compute as finding it requires finding many more numbers.

Observed in quantum optics [2-4] was that when the operators defining the equation of motion for the density matrix, called quantum jump operators were added to the dynamics of the wave function in a certain way, they created a new equation of motion for a vector called the wavefunction. The time expectation value of what is called the outer product of the solution of this vector with itself equals the system's density matrix. This means that instead of time-evolving the N times N matrix elements of the density matrix one only needs to evolve the N vector components of the wave functions – a significant computational savings. Further established was the wave function equation of motion having the interpretation of being a Poisson stochastic process. Thus, instead of a completely deterministic time evolution, a mixing of determinism and stochasticity is possible: From the state of the system at the current time, one deterministically integrates the wave function equation of motion up to some waiting time at which the system jumps to a new state. This time is determined probabilistically, and the quantum jump operators, and the Monte Carlo sampling of the probabilities of the possible new states determine the new state. This process is repeated over and over. This is the wave function Monte Carlo method. It is sometimes called the quantum trajectory or the quantum jump method.

Quantum optics focuses on systems of one or a few atoms, with a few states each, interacting with each other and with a laser or other electromagnetic field. Two-state atoms, called qubits, are frequently studied because of their relevance to quantum computing and information. Extensions of the wave function Monte Carlo method to extended quantum systems, such as a chain of M interacting qubits, have adopted this procedure. In these extended systems, the size of the wave function vector N however typically scales as $N = 2^M, 3^M, 4^M, \dots$ where M is the number of atoms and 2, 3, 4, etc. are the number of states per atom. A qubit is a two state atom. Currently, the limit of the wave function Monte Carlo method is $M = 16-32$. $2^{32} = 4,294,967,296 \sim 4 \times 10^9$. We would like M to be few hundred: $2^{100} \sim 10^{30}$.

The bottleneck in the wavefunction Monte Carlo method is a step that requires the multiplication of a vector by a matrix. The matrix is sparse, meaning most of its elements are zero, but its order is huge: $2^M, 3^M, 4^M, \dots$. Clearly, to extend the present algorithm, we cannot keep doing exactly the matrix-vector multiplications for matrices and vectors of these sizes. Using Monte Carlo to estimate them is a long-standing effective alternative. Computationally, the essence of the proposal is breaking this bottleneck in the wavefunction Monte Carlo method by replacing the deterministic step with a Monte Carlo step. We would then do a Monte Carlo simulation in a Monte Carlo simulation. Furthermore, instead of evolving the systems by sequence of small steps, our new approach will allow the evolution by larger steps without any numerical errors.

We based our computational approach on the following: About 50 years ago, Feynman proposed an alternative formulation of quantum mechanics [5] that introduced the concept of a path integral. Almost all quantum Monte Carlo methods start with a path-integral formulation. We saw how to convert the wave function Monte Carlo method into a path-integral one, called the worldline method. The worldlines are just a discrete form of Feynman paths. Doing this conversion means we can replace the current Monte Carlo procedure with another one, eliminate the time discretization error, and more importantly at the same time eliminate the bottleneck preventing the wave function Monte Carlo insight being used for extended systems.

Scientific Approach and Accomplishments

Our approach starts with the observation that a common way to execute the time evolution of a quantum process is via a checkerboard decomposition of the worldline method. In this representation, the worldlines connect the corners of the black and white squares vertically or can

cross the black squares diagonally. Time is in the vertical direction, and space is in the horizontal one. What our observation does is connect simulating the present problem with quantum Monte Carlo methods developed finite-temperature equilibrium problems. It is the efficiency and power of these methods that we want to adapt.

A Monte Carlo method needs to generate many samples of the system being simulated and makes averages over these samples. A worldline Monte Carlo method samples by stochastically “wiggling” the worldlines. In the checkerboard representation, we can perform this wiggling by creating one initial configuration up to some time t (the bottom of the checkerboard), and instead of repeatedly restarting the simulation at some time $t=0$ (the top of the checkerboard) to create an entirely new set of worldlines, we instead build upon the one we have by repeatedly visiting just the white squares. At each visit, we decide stochastically whether to accept or reject a move of a worldline segment across the square. These moves are the quantum jumps, and stochastically jumping generates not only different initial states but also can sample the number of quantum jumps, the times at which they occur, and the jumped states.

The checkerboard worldline method was first developed for quantum Monte Carlo simulations of equilibrium thermodynamic problems. In these problems, the vertical axis does not represent time but the reciprocal of temperature, and Feynman’s prescription for finite temperature path-integrals requires the worldlines to be periodic in this dimension [5-7]. For the present problem, we do not want this constraint; it is easy to remove. In the equilibrium simulations, the number of electrons is conserved, and hence the number of worldlines. This also means the worldlines must be continuous. These facts are not true here as the quantum jump operators, that is, in the case of electrical transport, add and remove electrons at the left and right ends of the lattice. Accommodating these facts is the biggest adjustments we needed to make. They also require adding a weight to each worldline segment and locally updating them after each move. The weights allow us to exploit the sparseness of the effective Hamiltonian maximally but more importantly they also allow us to maintain a consistent quantum history.

A worldline algorithm typically uses the Metropolis algorithm to do the wiggling which in turn requires computing the ratio of the probabilities of the state of the system after and before the jump [6,7]. In the finite-temperature equilibrium case, the Metropolis ratio is as often negative as it is positive. In the present case, the Markov approximation for the physical dynamics, the analog of the molecular chaos approximation in the derivation of the

Boltzmann equation, requires sampling from the ratio of the positive probabilities. This makes a huge difference. The difference in part is the difference between a non-dissipative system and a dissipative one.

The essence of the new Monte Carlo method we want to implement comes from Monte Carlo methods for simulating quantum spin systems. The current wave function Monte Carlo method changes the configuration of the dynamics by making local changes in space and time. The methods from quantum spins make changes that are non-local in space and time that are inherently more efficient. Our plan was first to implement such algorithms within the checkerboard representation, that is, the discrete-time representation. In many cases, however, it is possible to replace the discrete-time worldlines with continuous one. After our discrete time implementation, our plan was to then consider a continuous-time implementation. This replacement eliminates the time-discretization error. Doing so eliminates a systematic error in the simulation and potentially boosts efficiency. There are 3 ways to achieve a continuous-time representation [7]: (1) taking the limit of dt to 0 analytically in the checkerboard representation, (2) using the worm algorithm, and (3) using the stochastic series expansion method. We used the latter because it maps better to the current problem [8,9]. We intended to implement the easier discrete-time method first and then use it to benchmark the more complex continuous-time code.

An even more preliminary objective was first implementing a even simpler, local Monte Carlo method to describe the transport of magnetization (quantum spin orientation) along a chain of interacting magnetic moments before implementing the more difficult non-local method. In the chosen model, the ends of the chain interact with an environment that favors the up-alignment of a moment at the hot end and a down-alignment at the other colder end. The preferential end alignments drive the transport of magnetization and energy across the chain. Published results for the model, using the present wave function Monte Carlo method with the deterministic solver, concluded that the resulting magnetization and energy currents satisfy the expected Fourier law of transport, including the independence of the final steady state of transport from the initial state, for sufficiently long chains. Our modification of the standard wave function Monte Carlo method failed to reproduce these published results. Not finding a programming error, we proceeded to resolve the disagreement, at least to our satisfaction, by following two lines of investigation.

One line of investigation consisted of solving the equations of transport by numerical methods implementing

a sophisticated predictor-corrector method for solving numerically the system of first-order ordinary differential equations that describe the transport. While very precise results are obtainable, the amount of computer memory needed restricts the use of such methods to same short chains to which the wavefunction Monte Carlo method is restricted. (Again, the existence of this restriction is why exploring Monte Carlo methods.) For the relatively short chain lengths possible, the solutions we obtained confirmed the dependence of the final state on the initial state. Independence however needs only to emerge only when the chain length becomes very long. Accordingly this study, while consistent with our Monte Carlo results, did not completely rule out the published results as they were reported mostly for longer chains.

In the second line of investigation, we explored the applicability of various theorems [10,11] that give a sufficiency condition for the independence. While these theorems have existed for a few years, we believe we are the first to apply them to a numerical as opposed to an analytical study of quantum transport. Their meanings are not very transparent but state that if the details of the interaction of the environment with the chain satisfy certain conditions, then the steady state (long time) transport chain is independent of the initial condition of the chain. The system under study however was found not to satisfy these conditions. Further, as the chain length becomes long, the deviance of the environment's interactions from sufficiency increases rapidly. While not satisfying sufficiency does not guarantee the absence of independence, this rapid increase in insufficiency points the published results almost certainly being incorrect.

These two investigations gave us confidence in our Monte Carlo results but left us without the simple test problem and the benchmarks on which we were relying. To compensate, we revisited our solver for the differential equations and improved it so we could get precise solutions for slightly longer chains lengths. One way to satisfy the steady-state sufficiency conditions for the model system is to increase the complexity of the interaction of the environment with the moments along the chain. We chose to do so by adding disorder at each site in the form of a external magnetic field acting on each magnetic moment.

With a more complex model, we now needed a more complex Monte Carlo code. We developed two codes: the present method and our first proposal for an improvement. Additionally, our experience with the differential equation solver pointed to the need for using a smaller time step than to one currently being reported in the literature to maintain accuracy for the long times it can take to reach the steady state. Accommodating this required some ad-

ditional recoding. We re-verified our numerical procedures against the differential equation solvers and added an additional set of measurements to supplement the measurement of the transport coefficient and to provide a more detailed description of the mechanisms for transport.

In benchmarking our code for the wavefunction Monte Carlo method against published one-dimensional simulations, we still experienced significant disagreements between what was published and what we were calculating. Specifically, the Monte Carlo predictions with the new and the previous definitions of the current did not agree with published results.

To resolve this disagreement, we developed a code to solve the master equation deterministically, that is, to solve the equation of motion for the density matrix. Having this code enables us to compare two quite different calculations of the same thing. We focused on comparing the density matrices as all measurements derive from it. The deterministic time-dependent results for the density matrix should agree with the Monte Carlo's ensemble averages as a function of time and the deterministic steady-state results should agree with the long-time average of the Monte Carlo results. Developing this code took considerable effort, in part because we could not use any portion of the wavefunction Monte Carlo code.

We found that the Monte Carlo averages agreed with the deterministic predictions only at small times and the differences did not, as they should, disappear as the Monte Carlo ensemble size, the length of integration time, or the accuracy of the differential solvers were increased. When we turn off the interaction between the heat baths and the open system, which removes the Monte Carlo from the problem, the two approaches agree perfectly which implies the problem is not with the way we calculate our measurements. If we look at the currents produced in the open systems by just the consequences of the heat bath, which emphasizes the Monte Carlo portion of the calculation, we see the disagreements. The bias, of the order of a few tenths of a percent, appears caused by the off-diagonal elements of the density matrix becoming small and exhibiting large statistical errors. Common measures of comparing density matrices, such as the trace norm and the entropy, imply a much better agreement between the two approaches; however, they are insensitive to these matrix elements. We are using a root mean-square measure that is more common to Monte Carlo simulations.

Trying to resolve whether the observed disagreement was a coding error, a numerical error, or an inherent deficiency took quite a bit of time. We were able to move forward after we discovered a consortium of researchers who very

recently developed a software package called QuTip [12] that implement the standard version of the wavefunction Monte Carlo method and a deterministic solver for the master equation. Using it on our models generated the same minor discrepancy between the density matrices produced by the two approaches and the same disagreements between the measures for comparing the similarities of two density matrices. We now have sound reasons to believe our codes are correct.

The QuTip software package supersedes the software we developed in terms of a more convenient and flexible interface for input and output. Our deterministic solvers are more powerful, however, that power however seems less important than what we would gain by using QuTip. What QuTip lacks the Monte Carlo replacement for the deterministic matrix-vector multiplication that we are developing. Our plan became to develop it and then integrate it into the QuTip computing environment.

As the remaining time for the project was short, we leapfrogged over our planned development of these newer non-local Monte Carlo methods first in discrete-time and then into continuous-time and started the development of the continuous-time version. We fortuitously discovered an old paper [13] in the literature that proposed a different continuous-time solver than presently used that had the promise of eliminating what is called the waiting-time problem. We succeeded in adding the non-local moves to it and in accomplishing the core of its development. We did not have time to use it for quantum jump process and integrate it with QuTip.

Our four main accomplishments will be detailed in intended publications. They are: (1) the proper definitions for the computation of current, (2) the observation of the discrepancy between the density matrix computed by the deterministic and Monte Carlo method, (3) the misleading information in the standard metrics for the closeness of two density matrices, and (4) the new continuous time solver for quantum dynamics. In future projects we intend to integrate the later into QuTip.

Impact on National Missions

The objective of this project is the development of a new computational capability. We emphasize that it has a broader range of applications than nanotechnology. This range umbrellas the same range of activities as the Laboratory's proposed materials flagship, MaRIE, and will provide useful tools for researchers engaged in this project. While the focus of this project is on transport, the seminal ideas came from quantum optics where the focus is the interaction of a few cold atoms with electrostatic traps and the interaction of an atom with a laser. Accordingly, the new

computational tool has multiprobe utility. Quantum optics and MaRIE share the same goal of prediction and control. In fact, the integration of the proposed research with MaRIE would give MaRIE a distinctive look. Additionally, the new computational capability will create new opportunities for high performance computing. The Monte Carlo method is a natural for exascale computing.

References

1. Nelson, E.. Dynamical theories of Brownian motion. 1967.
2. Breuer, H. P., and F. Petruccione. The theory of open quantum systems. 2006.
3. Dalibard, J., Y. Castin, and K. Molmer. Wave function approach to dissipative dynamics in quantum optics. 1991. *Physical Review Letters*. 68: 580.
4. Plenio, M., and P. L. Knight. The quantum-jump approach to dissipative dynamics in quantum optics. 1998. *Reviews of Modern Physics*. 70: 101.
5. Feynman, R. P., and A. R. Hibbs. Quantum mechanics and path integrals. 1965.
6. Negele, J. W., and H. Orland. Quantum many body physics. 1987.
7. Evertz, H. G.. The loop algorithm. 2003. *Advances in Physics*. 52: 1.
8. Sandvik, A. W.. Finite size scaling of ground-state parameters of the two-dimensional Heisenberg model. 1997. *Physical Review B*. 56: 11678.
9. Sandvik, A. W., and H. G. Evertz. Loop updates for variational and projector Monte Carlo simulations in valence-bond basis. 2010. *Physical Review B*. 82: 24407.
10. Spohn, H.. Kinetic equations from Hamiltonian dynamics. 1980. *Reviews of modern physics*. 53: 569.
11. Spohn, H., and J. L. Lebowitz. Irreversible thermodynamics for quantum systems weakly coupled to thermal reservoirs. 2009. In *Advances in chemical physics: for Ilya Prigogine*. By Rice, S. A., p. 109. Hoboken: Wiley-Interscience.
12. Johansson, J. R., P. D. Nelson, and F. Nori. QuTip2: a Python framework for the dynamics of open quantum systems. 2013. *Computational Physics Communications*. 184: 1234.
13. Angelis, G. F. De, G. Jona-Lasinio, and M. Sirugue. Prob-

abilistic solution of Pauli type equations. 1983. Journal of Physics A: Mathematical and General. 16: 2433.

Publications

Gubernatis, J. E.. Sign and Phase Problems: Monte Carlo for the unsampleable. Invited presentation at Monte Carlo Methods in the Physical and Biological Sciences. (Providence, RI, 29 Oct - Nov 2, 2012).

Gubernatis, J. E.. Wavefunction Mote carlo for transport in open quantum systems. Presented at March Meeting 2013, American Physical Society. (Baltimore, 18-22 Mar. 2013).

Gubernatis, J. E.. Exact dynamics via Poisson processes. Presented at March Meeting 2014, American Physical Society. (Denver, 3-7 Mar 2014).

Hu, F. M., T. O. Wehling, J. E. Gubernatis, T. Frauenhein, and R. M. Nieminen. Magnetic impurity affected by spin-orbit coupling: behavior near a topological phase transitions. 2013. Physical Review B. 88: 045106.

Ren, J., J. X. Zhu, J. E. Gubernatis, C. Wang, and B. Li. Thermoelectric transport with electron-phonon coupling and electron-electron interaction in molecular junctions. 2012. Physical Review B. 85: 155443.

Somma, R. D., D. Nagaj, and M. Kieferova. Quantum Speedup by Quantum Annealing. 2012. Physical Review Letters. 109: 050501.

Phylogenetic Classification and Analysis of Computer Malware

Guanhua Yan
20120443ER

Abstract

Computer malware, which have plagued the Internet for more than two decades, are still growing rapidly and now responsible for most malicious activities in the cyber space. To defend against malware attacks effectively, we need to equip ourselves with malware forensic analysis techniques that not only reveal their sources accurately but also classify them within their families efficiently for quick response. The reality now is that malware analysis is either manually done by highly skilled malware forensic analysts or automated with error-prone signature-based scheme. The sheer volume of computer malware programs that appear every day demands new methods that can classify and analyze them more effectively and efficiently. Against this backdrop, we propose to develop techniques that are inspired by biological phylogenetics to classify and analyze computer malware. Phylogenetics is a field that studies the evolutionary relationships between recognizable groups ('taxa') of organisms, and has developed many mature methods for phylogeny inference. In this project, we will develop malware phylogeny that characterizes the evolutionary trajectories of millions of malware programs collected locally at LANL, organizing these malware programs into a structure with which new malware instances can be classified in an automated fashion. Such a classification would substantially enhance our ability to identify origins of malware attacks and aid forensic analysis. To complete this program, we will need to finish three sub-tasks successfully. First, we will analyze different features of malware programs, such as API sequences and function call graphs, and identify those with strong discriminative power. To find such a subset of features with minimal redundancy, we will also study the correlation among these features. Second, we will develop efficient clustering algorithms to group malware instances into families. We will compare multiple clustering algorithms such as k-means and hierarchical clustering and use labeled data to understand their accuracy and efficiency. Third, we will use likelihood-

based approaches, such as maximum likelihood inference and MCMC-based Bayesian inference, to infer the phylogenetic relationships within the different malware families. The process of building malware phylogeny will be computationally intensive, as it will be performed on a locally collected malware repository with millions of malware instances. Thus, we will consider both the effectiveness and efficiency of proposed methods and strike a balance between them. In this project, we will harness many resources that are unique to LANL, including a large malware repository with millions of malware programs, tremendous computational resources, and world-class domain expertise in both phylogenetics and cyber security. Also, this project is in concert with the increasing emphasis on cyber security research and development at the national level. The recent calls for proposals from both DARPA and DHS on cyber genome programs, nature-inspired cyber defense, and malware modeling all show that this project has a great promise to pursue further funding from outside government agencies. Moreover, this project also has the potential to build strong collaborations with the computer security industry as the proposed methods may significantly improve the existing practice of malware classification and analysis.

Background and Research Objectives

Malware classification and analysis is a tedious and time-consuming task that demands sophisticated reverse-engineering skills. According to the Internet Security Threat Report, more than 1.6 million new malware instances have been witnessed in 2008 alone, an 165% increase over the previous year (Symantec 2009). The sheer volume and increasing diversity of malware programs has called for automatic and efficient classification and analysis tools. A recent effort of malware indexing revealed that malware classification is largely done manually in the industry and this has significantly impeded the development of effective countermeasures (Hu et al. 2009). This project aims to develop malware

phylogeny for a large malware repository. This malware phylogeny can be used to classify new malware by finding close relatives automatically and efficiently, allowing for faster effective intervention. It also offers a comprehensive view of malware evolution, which greatly helps finding the originator of a new malware attack. Thus, this work has the potential to revolutionize the existing practice of malware classification and attribution.

Scientific Approach and Accomplishments

In this project, we constructed a large number of features from more than 500K malware samples. These features include: (1) frequencies of n-gram byte sequences from binary malware code. We used the standard hexdump utility to derive this information; (2) frequencies of opcodes in instructions from disassembled code. The standard objdump utility uses the linear sweeping algorithm to disassemble code. Due to obfuscation techniques commonly applied in malware, it is well known that objdump may not be able to disassemble a lot of malware code. Hence, we also considered two other methods. One is the recursive descent algorithm, and the other a hybrid algorithm that combines both recursive descent and linear sweeping. We have collected features from all these three disassembly methods; (3) information collected from fields in PE (Portable Executable) headers, such as sizes of different sections and DLLs (Dynamic link libraries) imported. The majority of existing malware targets the Microsoft Windows system and thus uses the PE file format. We have collected hundreds of features from the PE header of each malware executable; (4) frequencies of instructions invoked from dynamic execution of malware samples in a controlled environment; (5) function call graphs that represents calling relationships among functions inside malware code. In addition to these malware samples, we also extracted features from 600 benign executable programs.

In order to find discriminative features that distinguish individual malware families, we uploaded MD5 signatures of the 500K malware instances to VirusTotal ([https:// www.virustotal.com/](https://www.virustotal.com/)), an open malware classification website, and obtained detection results from more than 40 anti-virus companies. Combining detection results from these companies, we were able to label 25K malware samples into 12 major malware families with high confidence. These labeled malware samples served as ground-truth for us to find important features (or “genes”) that are representative of individual malware families. Given the labeled malware samples and benign executable programs, we ran python-based tools to detect whether they are packed or not.

We then developed python-based machine learning codes

that select important features to distinguish malware families. We considered all three major feature selection techniques. (1) The filtering method, which selects features based on individual relevance scores. We have found that the Relief score, which measures the interclass dissimilarity against intra-class dissimilarity, is particularly useful for ranking the importance of each feature in malware classification. We have used a number of classification methods, including Naive Bayes, decision trees, support vector machines, and the k-nearest neighbor algorithm, to study how sensitive features are to the choice of specific classifiers in classification; (2) The wrapper method, which selects features against a specific classification technique. As this method is much slower than the other two methods we have considered, we did not invest a lot of time on it; (3) The embedded method. We formulated the malware feature selection problem as a logistic regression problem based on L1-regularization. We tested various combinations of feature selection and classification methods, and studied the discriminative power of different types of malware features. The results are currently under submission at a peer-reviewed conference.

We also used IDA-pro, a commercial disassembler and debugger, to disassemble all the labeled malware programs and benign executable programs. We developed codes to reconstruct the flow control graph of each malware. The flow control graph includes not only information about how functions call each other, but also transition among basic code blocks (without jumping instructions inside each code block). Based on the flow control graph, we developed metrics that effectively explain the similarity of two malware programs belonging to the same family.

In summary, we developed a principled solution to finding consensus in data clustering by multiple experts. Our project requires labeled data as ground truth to study malware evolution. As manually labeling a large number of malware samples is difficult, we rely on the classification results by multiple AV software to group malware samples. We formulate the problem rigorously and show that finding an optimal solution is computationally intractable. We further proposed a graph theory-based method to find sub-optimal solutions. Using this labeled data, we developed a framework for automated malware classification. This framework can combine various types of malware features, some of which may have missing values, and use the Neyman-Pearson criterion to search optimal parameters of cost-sensitive classifiers. We also developed a new transductive malware classification method to spread label information from labeled samples to unlabeled ones. Finally, we ran phylogenetic software based on maximum-likelihood principles on the features we have collected

from a few malware families to show their evolution. We interpreted the results and evaluated how accurately the malware phylogeny reflects the realism.

Impact on National Missions

This project meets priorities of Information, Science and Technology. It contributes to the Inference/Prediction priority by demonstrating statistical inference methods for the history of malware programs even though their evolution involves human intelligence. We advanced the data intensive computing priority by developing efficient algorithms to extract representative features from a large malware database that contains millions of malware programs. Underlying these efforts is the realization that cyber-threat reduction is among the core missions of LANL. This project connects that capability with our leadership in the application of phylogenetics to biological (viral) systems, and develops a novel capability within cyber security science.

Publications

Kong, D., and G. Yan. Poster: Discriminant Malware Distance Learning on Structural Information for Automated Malware Classification. 2013. In Proceedings of the ACM SIGMETRICS/international conference on Measurement and modeling of computer systems (SIGMETRICS'13). (Pittsburgh, PA, 17-21 June 2013). Vol. 41, 1 Edition, p. 347. New York: ACM.

Kong, D., and G. Yan. Discriminant malware distance learning on structural information for automated malware classification. 2013. In Proceedings of the 19th ACM SIGKDD international conference on Knowledge discovery and data mining (KDD'13). (Chicago, 11-14 Aug. 2013). , p. 1357. New York: ACM.

Kong, D., and G. Yan. Transductive malware classification: find your lineage from your neighbors. 2013. LA-UR 13-22771, Los Alamos National Laboratory..

Liu, L., X. Zhang, G. Yan, and S. Chen. Chrome Extensions: Threat Analysis and Countermeasures. 2012. In The 19th Annual Network & Distributed System Security Symposium (NDSS'2012). (San Diego, California, 5-8 Feb. 2012). , p. 1. Reston, VA, USA: Internet Society.

Yan, G.. Finding common ground among experts' opinions: conflict-free malware clustering for malware lineage analysis. 2013. LA-UR 13-22751, Los Alamos National Laboratory..

Yan, G., N. Brown, D. Kong, and M. Anghel. Towards a Comprehensive View of Feature Selection for Malware Classification. 2012. LA-UR 12-25308, Los Alamos National Laboratory.

Yan, G., N. Brown, and D. Kong. Exploring discriminatory features for automated malware classification. 2013. In

Proceedings of the 10th Conference on Detection of Intrusions and Malware & Vulnerability Assessment (DIMVA'13). (Berlin, Germany, 17-19 July 2013). Vol. 7967, p. 41. Berlin Heidelberg: Springer.

Yan, G., and S. Eidenbenz. Sim-Watchdog: leveraging temporal similarity for anomaly detection in dynamic graphs. 2014. In 2014 IEEE 34th International Conference on Distributed Computing Systems (ICDCS) . (Madrid, 30 Jun - 3 Jul 2014). , p. 154. Los Alamitos, California: IEEE.

Combinatorial Approaches To Graphical Models: Theory and Applications

Michael Chertkov
20120469ER

Abstract

In recent years, graphical models have come to play an important role in modern approaches to computer science and machine learning and have found many applications in various fields of science and engineering. In short, a graphical model is a statistical model for a collection of (possibly very many) random variables in which correlations among the variables are succinctly described by a sparse set of interactions or constraints among small subsets (e.g., pairs or triplets) of variables. The conditional independence relations (Markov properties) satisfied by these variables are then summarized by a graph in which vertices represent random variables and edges denote interactions among the variables. Although graphical models provide a powerful and versatile modeling framework, they suffer from fundamental challenges in that inference in general graphical models is computationally intractable. This has motivated an extensive and on-going research effort to develop computationally-tractable, heuristic methods for approximate inference in graphical models. We have developed advanced methods for graphical models derived from methods of statistical physics. More specifically we built on tractable methods developed for special classes of graphical models. For example, while inference is intractable for some models, like the Ising and dimer models on general graphs, it becomes tractable for planar graphs being equivalent to calculation of a matrix determinant or Pfaffian. These methods were originally developed to obtain estimates of lattice models in statistical physics and are little-known and under-utilized in the machine learning and optimization communities. Our research goals employed in the project can be broadly summarized as follows: (1) new methods for learning graphical models aimed at exploiting tractable computations on planar and bounded-genus graphs were developed; (2) new combinatorial analysis of inference in general graphical models and of some popular approximate inference methods such as belief propagation and its generalizations, providing improved convergence

and error analysis of these methods were developed; (3) inventing entirely new distributed approaches, based on extending Belief Propagation, to solve the inference problems of the matching type on arbitrary graphs; and (4) exploring new connections between the statistical physics based graphical approaches to control theory and applications, e.g. in energy systems.

Background and Research Objectives

In this project we pioneered advanced methods for graphical models using sophisticated techniques of statistical physics, combinatorics, algebraic graph theory, optimal fluctuation theory and to apply these methods in a wide range of fields such as optimization and control of energy system. The methods developed can be broadly classified into three areas: (1) novel methods for learning graphical models aimed at exploiting tractable computations on planar and bounded-genus graphs, (2) new combinatorial analysis of inference in graphical models and of some popular approximate inference techniques such as belief propagation and its generalizations; and (3) development of entirely new approaches to approximate inference that leverage efficient inference methods for planar graphical models so as to better approximate inference in other intractable classes of graphical models; (4) exploring new statistical physics based approaches to new emerging and applications driven (e.g. in energy systems) disciplines in optimization and control.

Scientific Approach and Accomplishments

Below we describe details (scientific approach and accomplishments) of the sub-projects summarizing the work on the project in the course of the three years.

Computation of the Partition Function for Perfect Matching. We discussed schemes for exact and approximate computations of permanents, and compare them with each other. Specifically, we analyzed the Belief Propagation (BP) approach and its Fractional Belief Propagation

(FBP) generalization for computing the permanent of a non-negative matrix. Known bounds and conjectures are verified in experiments, and some new theoretical relations, bounds and conjectures are proposed. The Fractional Free Energy (FFE) functional is parameterized by a scalar parameter $\gamma \in [-1; 1]$, where $\gamma = -1$ corresponds to the BP limit and $\gamma = 1$ corresponds to the exclusion principle (but ignoring perfect matching constraints) Mean-Field (MF) limit. FFE shows monotonicity and continuity with respect to γ . For every non-negative matrix, we define its special value $\gamma_* \in [-1; 0]$ to be the γ for which the minimum of the γ -parameterized FFE functional is equal to the permanent of the matrix, where the lower and upper bounds of the γ -interval corresponds to respective bounds for the permanent. Our experimental analysis suggested that the distribution of γ_* varies for different ensembles but γ_* always lies within the $[-1; -1/2]$ interval. Moreover, for all ensembles considered the behavior of γ_* is highly distinctive, offering an empirical practical guidance for estimating permanents of non-negative matrices via the FFE approach.

Belief Propagation for (general purpose) Linear Programming. Belief Propagation (BP) is a popular, distributed heuristic for performing MAP computations in Graphical Models. BP can be interpreted, from a variational perspective, as minimizing the Bethe Free Energy (BFE). BP can also be used to solve a special class of Linear Programming (LP) problems. For this class of problems, MAP inference can be stated as an integer LP with an LP relaxation that coincides with minimization of the BFE at "zero temperature". We generalize these prior results and establish a tight characterization of the LP problems that can be formulated as an equivalent LP relaxation of MAP inference. Moreover, we suggest an efficient, iterative annealing BP algorithm for solving this broader class of LP problems. We demonstrate the algorithm's performance on a set of weighted matching problems by using it as a cutting plane method to solve a sequence of LPs tightened by adding "blossom" inequalities.

A Graphical Transformation for Belief Propagation

Maximum Weight Matchings and Odd-Sized Cycles. Maximum 'belief propagation' (BP) is a popular distributed heuristic for finding the Maximum A Posteriori (MAP) assignment in a joint probability distribution represented by a Graphical Model (GM). It was recently shown that BP converges to the correct MAP assignment for a class of loopy GMs with the following common feature: the Linear Programming (LP) relaxation to the MAP problem is tight (has no integrality gap). Unfortunately, tightness of the LP relaxation does not, in general, guarantee convergence and

correctness of the BP algorithm. The failure of BP in such cases motivates reverse engineering a solution -- namely, given a tight LP, can we design a 'good' BP algorithm. To address the challenge we designed a BP algorithm for the Maximum Weight Matching (MWM) problem over general graphs. We proved that the algorithm converges to the correct optimum if the respective LP relaxation, which may include inequalities associated with non-intersecting odd-sized cycles, is tight. The most significant part of our approach is the introduction of a novel graph transformation designed to force convergence of BP. Our theoretical result suggests an efficient BP-based heuristic for the MWM problem, which consists of making sequential, "cutting plane", modifications to the underlying GM. Our experiments show that this heuristic performs as well as traditional cutting-plane algorithms using LP solvers on MWM problems.

Loop Calculus and Bootstrap-Belief Propagation for Perfect Matchings on Arbitrary Graphs. We analyzed computation of the Partition Function (PF) and the Minimum Weight Perfect Matching (MWPM) on arbitrary, non-bipartite graphs. We present two novel problem formulations - one for computing the PF of a Perfect Matching (PM) and one for finding MWPMs - that build upon the inter-related Bethe Free Energy, Belief Propagation (BP), Loop Calculus (LC), Integer Linear Programming (ILP) and Linear Programming (LP) frameworks. First, we described an extension of the LC framework to the PM problem. The resulting formulas, coined (fractional) Bootstrap-BP, express the PF of the original model via the BFE of an alternative PM problem. We then studied the zero-temperature version of this Bootstrap-BP formula for approximately solving the MWPM problem. We do so by leveraging the Bootstrap-BP formula to construct a sequence of MWPM problems, where each new problem in the sequence is formed by contracting odd-sized cycles (or blossoms) from the previous problem. This Bootstrap-and-Contract procedure converges reliably and generates an empirically tight upper bound for the MWPM. We conclude by discussing the relationship between our iterative procedure and the famous Blossom Algorithm of Edmonds '65 and demonstrate the performance of the Bootstrap-and-Contract approach on a variety of weighted PM problems.

Learning Planar Ising Models. Inference and learning of graphical models are both well-studied problems in statistics and machine learning that have found many applications in science and engineering. However, exact inference is intractable in general graphical models, which suggests the problem of seeking the best approximation to a collection of random variables within some tractable family of graphical models. To address the challenge we analyzed

the class of planar Ising models, for which inference is tractable using techniques of statistical physics. Based on these techniques and recent methods for planarity testing and planar embedding, we propose a simple greedy algorithm for learning the best planar Ising model to approximate an arbitrary collection of binary random variables (possibly from sample data). Given the set of all pairwise correlations among variables, we select a planar graph and optimal planar Ising model defined on this graph to best approximate that set of correlations. We demonstrate our method in simulations and for the application of modeling senate voting records.

Tail-Constraining Stochastic Linear-Quadratic Control: Large Deviation and Statistical Physics Approach. Standard definition of the stochastic Risk-Sensitive Linear-Quadratic (RS-LQ) control depends on the risk parameter, which is normally left to be set exogenously. We reconsidered the classical approach and suggest two alternatives resolving the spurious freedom naturally. One approach consisted in seeking for the minimum of the tail of the Probability Distribution Function (PDF) of the cost functional at some large fixed value. Another option suggests to minimize the expectation value of the cost functional under constraint on the value of the PDF tail. Under assumption of the resulting control stability, both problems are reduced to static optimizations over stationary control matrix. The solutions were illustrated on the examples of scalar and 1d chain (string) systems. Large Deviation self-similar asymptotic of the cost functional probability distribution function was analyzed.

Impact on National Missions

Our project has provided new powerful tools in learning of predictive statistical models from observations. Applications for these algorithmic and theoretical IT “know how” tools are many, ranging from bio- and genetic networks, detection of anomalies in infrastructure networks, inverse problems in seismology, reservoir exploration and discovery in oil fields, to probabilistic co-design based on limited measurements. Our project primarily addressed the Information Science & Technology Grand Challenge by providing a data-driven algorithmic tool for “Intelligent Data Acquisition, Management, And Analysis” (especially in what concerns Knowledge extraction, Automated discovery, Active learning, Anomaly detection, Data mining and Semi-supervised learning) and “Computational Co-design” (in what concerns integration of domain expertise, e.g. in statistical modeling of observational data, and novel machine learning techniques the project develops). This research helped LANL to respond to incoming National Initiatives, DOE, DOD, DTRA, DARPA and DHS related to monitoring, detection, control and analysis of large data sets.

Publications

- Chertkov, M., A. Gelfand, and J. Shin. Loop Calculus and Bootstrap-Belief Propagation for Perfect Matchings on Arbitrary Graphs. 2013. *The Journal of Physics: Conference Series (JPCS)*. 473: 012007.
- Chertkov, M., and A. B. Yedidia. Approximating the Permanent with Fractional Belief Propagation. 2013. *JOURNAL OF MACHINE LEARNING RESEARCH*. 14: 2029.
- Chertkov, M., and V. Chernyak. Statistical Inference in Structured Graphical Models: Gauge Transformations, Belief Propagation & Beyond. 2012. this is a big review -- still work in progress.
- Gelfand, A., J. Shin, and M. Chertkov. Belief Propagation for Linear Programming. 2013. In *ISIT 2013*. (Istanbul, Turkey, July 2013). , p. 0001. Istanbul Turkey : IEEE Explorer.
- Shin, J., A. Gelfand, and M. Chertkov. A Graphical Transformation for Belief Propagation: Maximum Weight Matchings and Odd-Sized Cycles. 2014. In *NIPS 2013*. (Lake Tahoe, CA, December 2013). , p. 0001. Lake Tahoe: IEEE Explorer.

Physics-Based Data Models and Architecture-Optimized Backends for a Portable Data-Parallel Computation Library

Christopher M. Sewell
20130418ER

Abstract

With the increasing heterogeneity and on-node parallelism of high-performance computing hardware, a major challenge to computational physicists is to work in close collaboration with computer scientists to develop portable and efficient algorithms and software. The objective of our work was to implement a portable code to perform interface reconstruction using NVIDIA's Thrust library. Interface reconstruction is a technique commonly used in volume tracking methods for simulations of interfacial flows. For that, we have designed a two-dimensional mesh data structure that is easily mapped to the 1D vectors used by Thrust and at the same time is simple to work with using familiar data structures terminology (such as cell, vertices and edges). With this new data structure in place, we have implemented a recursive volume-of-fluid initialization algorithm and a standard piecewise interface reconstruction algorithm. Our interface reconstruction algorithm makes use of a table look-up to easily identify all intersection cases, as this design is efficient on parallel architectures such as GPUs. We obtained performance results which show that a single implementation of these algorithms can be compiled to multiple backends (specifically, multi-core CPUs, NVIDIA GPUs, and Intel Xeon Phi coprocessors), making efficient use of the available parallelism on each.

Background and Research Objectives

A critical barrier to progress in high-performance computing is a pervasive lack of software portability among the wide variety of available hardware architectures. Code written to run on one platform rarely will run efficiently on a different platform, if it can run at all. For example, a program written in CUDA may run very efficiently on an NVIDIA graphics card, but cannot be compiled at all on any other platform. A program written in OpenCL may be able to run on both an AMD graphics card and on a multi-core CPU, but it will likely do a poor job of utilizing the available concurrency on either platform, at least without a significant time investment to

make platform-specific optimizations for each algorithm.

The solution to this challenge is not simply another programming language that can be compiled on different machines, but rather an abstraction that enforces a generic form of parallelism in the design of algorithms, that can then be easily mapped to the concurrency provided by many different architectures. In this regard, the data-parallel programming model offers great promise. In this model, all data is represented in one-dimensional arrays, and a set of primitive operators are defined that can be efficiently applied to all elements of an array simultaneously on any parallel architecture. Any algorithm written using only these primitives can then take advantage of the concurrency available on any hardware for which implementations of these primitives exist.

The Thrust library from NVIDIA provides the basic building blocks of this programming model: a vector data type and implementations of data-parallel primitives in CUDA, OpenMP, and Intel Threading Building Blocks. However, in order to be useful to scientists at Los Alamos and elsewhere, much needs to be added to this core provided by Thrust. On the front end, a new data model (rather than simply one-dimensional vectors) needs to be devised in order to map easily to the problem domains of simulations (such as 3D meshes), and on the back end, implementations of the data parallel primitives are needed that run efficiently on many more architectures than are currently supported. Once the implementations of the small set of primitives have been optimized on a platform, the programmer of an operator algorithm no longer needs to worry about making platform-specific optimizations.

Through a co-design process involving computer scientists, application scientists, and hardware vendors, we made strides towards providing a framework in which scientists can easily map their simulations and visualization and analysis operators onto a data-parallel model

and efficiently run their code on emerging parallel technologies.

Scientific Approach and Accomplishments

We have implemented 1D, 2D, and 3D mesh data structures using our Pinion framework that allow physicists to easily map a structured grid to the 1D vectors used by Thrust. The design of the mesh data structures provides an interface familiar to computational physicists while introducing them to the concept of the data parallel programming model. This enables them to take advantage of the available parallelism while still thinking in terms of familiar structures such as cells, vertices, and edges. This is the result of several iterations of tight and productive cooperation between the computational physicist and the computer scientists of the team. We have implemented volume fraction initialization using all three of these mesh data structures, as well as gradient and interface reconstruction for the 2D case. The details of this implementation, as well as strong and weak scaling results for the same code compiled and run on GPUs, multi-core CPUs, and Intel Xeon Phi (MIC) accelerators, are presented in our paper “Volume-of-Fluid Interface Reconstruction Algorithms on Next Generation Computer Architectures”, accepted for the Proceedings of the ASME 2014 4th Joint US-European Fluids Engineering Division Summer Meeting and 12th International Conference on Nanochannels, Microchannels, and Minichannels, August 2014.

We purchased a small cluster of Intel Xeon Phi (MIC) nodes, which have been successfully installed within our group’s Darwin cluster, and we have extensively studied this architecture (including attending several MIC programming workshops). We have run our PISTON isosurface operator, using the existing OpenMP backend, directly on an Intel Xeon Phi coprocessor (i.e., in “native” MIC mode), with good scaling results with the number of threads. We then modified the OpenMP backend for selected data-parallel primitives in order to improve vectorization performance on the Xeon Phi. We have also implemented backends for a small number of Thrust primitives using the “offload” mode (in which some processing is performed on the host and some on the coprocessor).

Furthermore, we have extended the Thrust library to support concurrency in distributed memory environments across multiple nodes. This enables the application developer to write data-parallel algorithms while viewing the data as single, long vectors, essentially without needing to explicitly take into consideration whether the values are actually distributed across nodes. Our distributed wrapper for Thrust handles the communication in the backend using MPI, while still using the standard Thrust library to take

advantage of available on-node parallelism. We have written distributed implementations of several key data-parallel primitives, including scan, scatter/gather, sort, reduce, and upper/lower bound. The details of this distributed backend are presented in our paper “Portable Data-Parallel Visualization and Analysis in Distributed Memory Environments”, published at the IEEE Symposium on Large-Scale Data Analysis and Visualization, October 2013. We have also successfully run our 2D volume fraction initialization, gradient, and interface reconstruction algorithms using this distributed implementation on multiple Xeon Phi (MIC) coprocessors on the Stampede cluster at the Texas Advanced Computing Center.

Impact on National Missions

The deliverables and the experience resulting from this work will help build laboratory capabilities in programming models within the larger exascale computing co-design missions. The physics targeted by our front-end work was chosen to support the type of simulations critical to the DOE Nuclear Energy Programs and other DOE agencies, while the architectures targeted by our back-end work were selected to support the specific hardware that will be likely to be used in the laboratory’s next generation of supercomputers. The deliverables of this project, including interface reconstruction that can achieve good performance on several next-generation supercomputing architectures, could be used to interface with compressible multi-material hydro codes used extensively in the ASC program and in X Division. This work should also be complementary to other work on cross-platform high-performance computing at the laboratory. For example, the physics code resulting from this work could potentially be compiled by the compiler being developed by the Scout project, with this work providing a useful application and data abstraction for Scout, and the low-level compiler optimizations made by Scout providing an opportunity for further performance enhancement for this work. We have actively made connections with related work at the lab for preparing codes for next-generation architectures, especially the Eulerian Applications Program – Future Architectures team (EAP-FA), and believe that our work and experience from this project can contribute to such efforts.

Publications

Francois, M., L. Lo, and C. Sewell. Volume-of-Fluid Interface Reconstruction Algorithms on Next Generation Computer Architectures. To appear in Proceedings of the ASME 2014 4th Joint US-European Fluids Engineering Division Summer Meeting and 12th International Conference on Nanochannels, Microchannels, and Minichannels. (Chicago, August 2014).

Sewell, C., L. Lo, and J. Ahrens. Portable data-parallel visualization and analysis in distributed memory environments. 2013. In IEEE Symposium on Large-Scale Data Analysis and Visualization. (Atlanta, Georgia, 13-14 Oct. 2013). , p. 25. Atlanta, GA: IEEE.

Co-Design of Burst Buffer Hardware and Data Analysis/Visualization Software for Large-Scale Simulations

Jonathan L. Woodring
20130457ER

Abstract

Development of an in-transit solution for data analytics that utilize burst buffer technology requires an understanding of the burst buffer's capabilities relative to the analysis and simulation workloads. Burst buffers are next-generation storage technologies in support of high-performance scientific computing. In-transit analysis is analytics done as data are being copied from the source (simulation or supercomputer) to the long-term storage. This research explores the intersection of large-scale data analytics and burst buffers. A prototype burst buffer system has been constructed using estimates of expected technology and deployment strategy from LANL's next supercomputing project. Initial testing was completed on this prototype burst buffer to determine bandwidth capabilities (for both file read and write) under various I/O and compute and analysis conditions. Thus, our research determines how data could be ingested and read back and the feasibility of in-transit analytics of large-scale data, due to peta-scale and exa-scale scientific computing, analytics, and large-scale simulations being I/O constrained.

Background and Research Objectives

These tests were conducted with a commercially available file system configured across the burst buffer hardware experimental platform. It can be configured to place files onto the storage media using two configurations: distributed or scattered placement. Distributed is a mode that mimics the Hadoop Distributed File System and Google File System's placement policy, which calls for the clustering of files that can be passed back to a locally running application as a unit of work. It allows for the querying of file locality data to allow for the placement of the analytics code on the same node containing the data to be processed. This is how commercial analysis systems, like Spark and Hadoop, achieve performance, by moving running code to data. In comparison, the scattered placement policy is the normal placement policy for many file systems and strives to stripe file

blocks as widely across the available storage media, to gain the aggregate performance (bandwidth) of as many drives as possible.

For workload testing, a parallel scientific Fortran application for the oceanographic meridional overturning circulation (MOC) was used. It was written and used by LANL ocean modelers and users of LANL's Parallel Ocean Program (POP). It serves as a prototypical application capable of utilizing in-transit data transfer to improve the overall performance of a simulation. The meridional overturning circulation is a system of both surface and deep currents common to all ocean basins. It transports large amounts of water, heat, salt, carbon, nutrients and other substances around the globe, and connects the surface, ocean, and atmosphere with the huge reservoir of the deep sea. It is therefore of critical importance to an understanding of the terrestrial climate system and it is a real-world use case analysis scenario for burst buffers.

Scientific Approach and Accomplishments

Before workload testing, a calculation of the theoretical peak performance expected from the burst buffers and solid state drives (SSDs) was conducted to determine what the upper bound on I/O bandwidth. Looking at the data path in the system, it was determined that the SSDs would be the slowest component in the system and thus the limiting factor to performance, but also showing that distributed performance gained the best I/O bandwidth (Figures 1-2).

The following test results shown here (Figure 3) are reflections of the actual performance expected of the analysis codes when operating on the data already within the burst buffers (rather than copying data to the code) rather than the traditional parallel file system. The read performance is indicative of the performance to pull stored data to RAM for processing, while the write performance is what is expected for performance of sav-

ing analysis products back to the local flash pool from the simulation vs. the parallel file system.

A comparison of the following in Figure 3 shows a significant reduction in I/O read time for the data input to our MOC computer program where we have used the localized read functions vs. remote read functions. The combination of parallel execution and the use of the burst buffers improve the I/O times sufficiently such that the total run time for our test is reduced by 10 minutes. This is a highly significant improvement over the standard un-optimized execution without burst buffers, representing an improvement of 100% or 2:1.

Impact on National Missions

Testing of the burst buffer prototype setup shows both functionality and performance necessary to continue building the proposed capability and integrating it into future supercomputing platforms. The distributed file system capability has shown itself to perform on par or better than a standard scattered placement mode. As a result, we can, without a loss in performance and gain end-to-end performance, use a distributed file system and burst buffers to ingest simulation data. This allows analytics applications to optimally access the data in-transit, with little network communication, to produce the desired analytics and results.

This has a direct impact on all large-scale DOE simulation efforts done across the laboratories (both NNSA and SC), as it shows greater performance in both the simulation and analysis codes through the use of burst buffers and in-transit analysis.

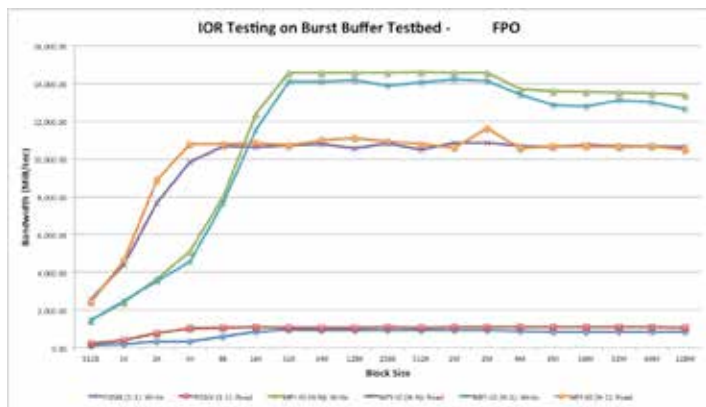

Figure 1. Distributed file burst buffer performance.

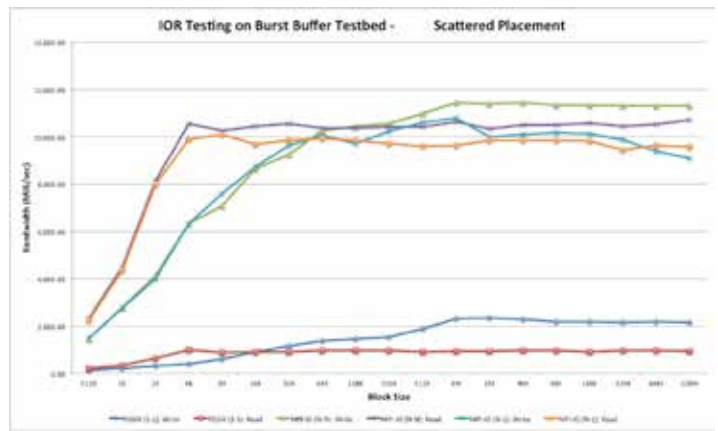

Figure 2. Striped file burst buffer performance.

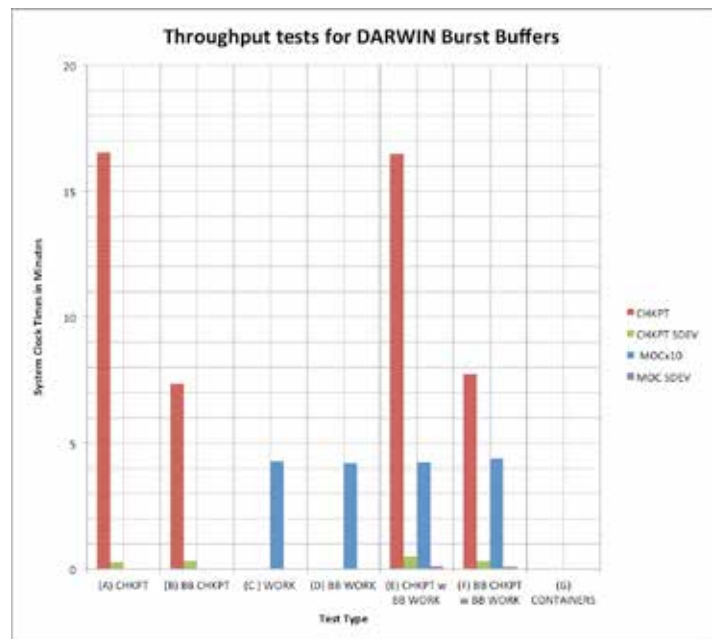

Figure 3. Different workload performance on a burst buffer, showing that using a burst buffer for simulation and analytics results in a huge performance gain (roughly 2:1).

Publications

Mitchell, C., D. Bonnie, and J. Woodring. In-Transit Processing: Data Analysis using Burst Buffers. 2014. In High Performance Parallel I/O. Edited by Prabhat, , and Q. Koziol. , p. 171. Boca Raton, FL: Chapman and Hall/ CRC.

Mitchell, C., D. Bonnie, and R. Knight. Co-Design of Burst Buffer Hardware and Data Analysis/Visualization Software for Large-Scale Simulations: Burst Buffer Initial Test Report, August 2013. 2013. LA-UR-13-27974, Los Alamos National Laboratory.

Validating Near-Ideal Data Throughput Using a Rate-Compatible Protocol

Scott H. Robinson
20130504ER

Abstract

This project combined an advanced information coding technique with a specialized transmission protocol that demonstrates the ability to maintain near-ideal data throughput performance regardless of the noise present in a wireless communication channel. With careful logic architecture the project efficiently implemented complex algorithms in standard hardware. Testing under laboratory conditions demonstrated the design's ability to dynamically adjust the message coding rate to maximize data throughput and increase spectrum efficiency. The design is compatible with existing wireless modulation and signal bandwidth allowing it to provide increased capabilities to existing communications systems. Any mission or agency concerned with the efficient and reliable delivery of digital information in the presence of dynamically changing interference or jamming could benefit from this work.

Background and Research Objectives

Information coding, the application of mathematic algorithms to data to achieve specific results, is central to the error-correction techniques that are employed to reliably transmit data through a noisy communications channel. Using a specialized algorithm a transmitter will generate a set of parity bits and append them to the packet of data. These parity bits are then used by a receiver to correct any errors in the data that occurred during transmission. The more noise present in the channel the more errors will occur in the data requiring more parity bits to recover the data.

Traditional techniques use a fixed rate code where a set number of parity bits are appended to each data message. The ratio of the number of data bits to the number of data bits plus the number of parity bits (its code rate) is generally determined by the signal to noise ratio (SNR) the communication system is expected to operate in. Below the predetermined SNR level the message can't be recovered. Above the predetermined SNR level

the data message can be transmitted reliably. However, since a fixed rate code is employed the data throughput rate remains constant even when the channel conditions are excellent resulting in channel data capacity going unused. Examples of traditional fixed rate codes include convolutional coding and Reed-Solomon coding.

Low Density Parity Check (LDPC) codes are a class of forward error correction codes. The general field of LDPC codes is composed of many different families characterized by a number of differing properties including the structure of the parity check matrix, the encoding or decoding complexity and the method of code construction. LDPC codes are currently used in many modern communication systems such as the DVB-S2 standard, the CCSDS body of space data standards and IEEE 802.16 WiMAX. These systems employ LDPC codes using a fixed rate coding scheme.

LDPC codes can be implemented as rateless codes - the idea that an unlimited number of parity bits can be generated for any given user data message. Rateless codes have been employed commercially, one example being Fountain codes. These codes can be efficient when a big data file needs to be distributed to a large number of widely distributed receivers but is inefficient when the communication is between a single transmitter/receiver pair and involves random sets of data.

Previous work developed a model for a rate-compatible protocol that could maintain near ideal data throughput in a dynamically changing noise environment. This design combined an LDPC coding with a specialized transmission protocol to enable maximum performance regardless of the interference present in a wireless (Radio Frequency or RF) communication channel. Working together, the coding technique and the transmission protocol dynamically tunes the throughput rate of each data message to adjust to rapidly changing interference in the transmission channel. This is done automatically

with a minimum amount of feedback and no specialized equipment to measure the quality of the channel. The result is a data transfer rate that approaches the theoretical maximum set by the Shannon limit.

Traditionally wireless communication systems have employed other methods to maintain data throughput across a noisy channel. These other methods include increasing the power of the transmitter or the use of a more complex signal modulation technique. The proposed rate-compatible protocol operates independent of these techniques. For this reason the rate-compatible protocol is both compatible with and complimentary to the other techniques.

Previous work resulted in a high level computer model and a technical report. The objective of this engineering LDRD project was to implement the rate-compatible protocol in hardware and demonstrate its performance under laboratory conditions. Specifically, the goals of this effort were to demonstrate that the rate-compatible protocol:

- could maximize data throughput capacity across a wide range of SNR;
- dynamically adjust its coding rate to changing SNR without a priori knowledge;
- minimize the amount of back channel communication from the receiver;
- could be implemented using common communication hardware;
- is compatible with existing modulation and channel bandwidths.

This work would raise the technical readiness level of the rate-compatible protocol from TRL3 to TRL6.

To achieve these objectives the team had to make some engineering trades sacrificing certain design optimization in order to build an initial demonstration system. This resulted in a message payload smaller than typically used which impacted overall performance. However, by the end of the project the design was fully functional in the laboratory, demonstrated all the critical components operating in hardware and was built to allow it to be readily expanded to larger message payloads.

Scientific Approach and Accomplishments

A Weight-3 Repeat Accumulate (W3RA) LDPC code was selected for this project due to its reduced complexity, lending itself to hardware implantation while still providing good performance. Generally these codes will use at least 1,000 code bits. The more code bits the more efficient the code is in correction errors providing better performance. One of the engineering trades made by the project was

to select a short code length that could be quickly implemented in hardware and yet provide enough performance to validate the research objectives. A length 360 rate 0.50 W3RA code was selected which creates an encoded codeword with 180 data bits and 180 parity bits.

The Sum-Product-Algorithm (SPA), an iterative algorithm based on belief propagation, is used to decode the W3RA LDPC code. The decoder uses received message bits combined with reliability information indicating the probability that a bit is correct. The decoder then iteratively processes the data through the algorithm while updating the reliability information. Processing continues until the reliability information converge indicating success or the decoder detects that the reliability information is diverging indicating that decoding has failed and more parity bits are needed.

The project used parity bit puncturing to implement various code rates. Puncturing selectively removes parity bits prior to transmission. At the decoder side the removed parity bits are simply treated as bits with zero reliability information. Five different levels of puncturing were used to produce five different code rates of 1.00, 0.80, 0.67, 0.57 and 0.50. For a rate 1.00 all parity bits are punctured meaning that no parity bits are sent with the data message. For a rate 0.50 no parity bits are punctured and all parity bits are sent. All other rates have varying numbers of punctured bits with decreasing code rate indicating fewer punctured bits.

The encoded data bits and associated parity bits are then transmitted using a specialized transmission protocol that controls the number of parity bits sent depending on the noise in the communication channel. The rate-compatible protocol demonstrated by this project is illustrated in Figure 1. The protocol follows these steps.

1. A 702-bit data word is collected and a 16-bit CRC is appended to the end.
2. The 720-bit combined data block is split into four 180-bit subwords and each is encoded with the W3RA encoder giving four 360-bit codewords each with its own set of parity bits.
3. During the first transmission no parity bits are sent. A 127-bit BCH header is prepended to the message to indicate to the receiver if the payload is data or parity.
4. The receiver performs a CRC check and if it has failed to recover the message without errors it then requests additional parity bits from the transmitter.
5. The transmitter sends 180 parity bits, 45 bits for each of the four subwords. Again a BCH header is prepended.

ed to the message to indicate which parity bits are being sent.

6. At each step in this process the receiver performs SPA decoding on the previously received data and parity bits along with the newly arrived parity bits. If the decode is successful then the protocol is complete and the receiver signals success to the transmitter indicating that a new data message can be sent. However, if the decode fails then the receiver requests additional parity bits from the transmitter and the process repeats.

The BCH header prepended to each transmitted message is necessary for informing the receiver of what data is being received. Critical to the operation of the protocol is the requirement that the BCH code be powerful enough to allow the header information to be recovered even at the lowest SNR levels. For the short length code implemented by the project the BCH header makes up a significant part of the overhead that is added to the data, lowering the effective code rate. However, the size of the BCH header would not change when a longer code is used, greatly reducing its impact on the overall code rate.

Complete versions of both the encoder and decoder were implemented in a Xilinx Virtex-6 field programmable gate array (FPGA). For the encoder this included the W3RA encoder, the puncturing logic, the BCH message header encoding, and the transmitter portion of the rate-compatible protocol. For the decoder this included the receiver portion of the protocol, the BCH message header decoder, the logic to process the punctured parity bits and the belief propagation logic using the SPA. A Gaussian white noise generator was also implemented in the FPGA to insert random errors into the information going between the encoder and decoder based on a selected SNR level. Software on an external computer was used to control testing of the rate-compatible protocol in the FPGA and to analyze results.

Results from laboratory testing of the design showed the following results.

Research objective 1: Figure 2 shows the ability of the rate-compatible protocol to maximize data throughput across a wide range of channel conditions. At high SNR levels the throughput performance of the design significantly exceeds the performance of the traditional fixed rate one-half convolutional code. As the SNR drops so does the data throughput rate of the protocol as expected. At the lowest SNR levels the performance of the rate-compatible design does drop below that of the traditional fixed-rate code due to the inefficiencies of the short code length currently

implemented by the project. By scaling up to longer code lengths the performance advantage of the rate-compatible protocol would be extended to lower SNR levels and allow it to track much closer to the Shannon Limit across all SNR levels. Figure 2 also shows the effect the BCH header has on the overall performance. A longer code would minimize the impact the BCH header has on the design. The design of the rate-compatible protocol created by this project allows the logic to be readily expanded to longer codes.

Research objective 2: Figure 3 shows the ability of the rate-compatible protocol to adjust its coding rate based on the conditions of the transmission channel (note that the listed rates include both the BCH overhead and parity bits). At the highest SNR levels all data messages are successfully delivered using the highest coding rate. As the SNR drops errors are introduced to the transmitted message requiring a lower coding rate. Since errors are inserted randomly the coding rate required at a specific SNR level varies. The rate-compatible protocol dynamically adjusts its coding rate to take advantage of this variability maximizing overall data throughput.

Research objective 3: The receiver sends a simple positive or negative acknowledgement back to the transmitter indicating whether or not a specific data message has been successfully decoded. A positive acknowledgement means the transmitter can send the next data message in the queue. A negative acknowledgement means that the transmitter needs to send the next set of parity bits for the current data message. It is important to note that the transmitter only sends additional parity bits; it does not retransmit the entire data message. This is a major difference between the rate-compatible protocol and systems using traditional fixed rate codes.

Research objective 4: All critical functions of the rate-compatible protocol were implemented using a standard commercial FPGA clearly demonstrating the designs compatibility with common communication hardware. Furthermore, the design was created using an industry standard hardware description language without using any proprietary design resources. This allows the design to be readily ported to other commercial hardware or even into a custom integrated chip.

Achieving an efficient implementation of the W3RA encoder in FPGA logic is relatively straightforward. However, implementing a SPA decoder requires several large matrices that have to be accessed multiple times during many iteration cycles. These requirements put a heavy load on both memory and routing resources inside a FPGA and make it difficult to parallelize the logic to increase execution speed. Through careful design an architecture was

developed to address these issues allowing the design to be scaled up to much longer code lengths.

Research objective 5: The encoded data frame that is sent from the transmitter to the receiver is a simple stream of bits. This bit stream is fully compatible with existing RF signal modulation methods and frequency bandwidths. Because of this compatibility the rate-compatible protocol can increase the data throughput capacity of an existing communication system.

Impact on National Missions

This project has demonstrated technology that can significantly increase the data throughput capacity of existing RF communication links. Any mission or agency concerned with the efficient and reliable delivery of digital information in the presence of dynamically changing RF channel conditions could benefit from this work.

NNSA is responsible for satellite instruments to meet national treaty monitoring requirements. This includes the delivery of sensor data to the ground during ionospheric disruptions. The rate-compatible protocol could ensure maximum data delivery under these dynamically changing conditions. Agencies including NNSA, DOD, NASA and numerous Intelligence Agencies rely heavily on wireless communications to perform various remote sensing missions. Often these RF links must operate when the condition of the communication channel is changing due to natural interference, weak transmission signals or intentional RF jamming. The rate-compatible coding algorithm and transmission protocol can significantly improve the performance of these links.

The annual growth in commercial wireless data traffic has been predicted at 74% over the next couple years - much of it due to expanded use of smartphones. Due to the mobility of these devices channel conditions constantly change due to their distance from a base station; intervening buildings or terrain; and noise present in the environment. The rate-compatible protocol can improve the performance under all these conditions while increasing the data carrying capacity of the RF spectrum.

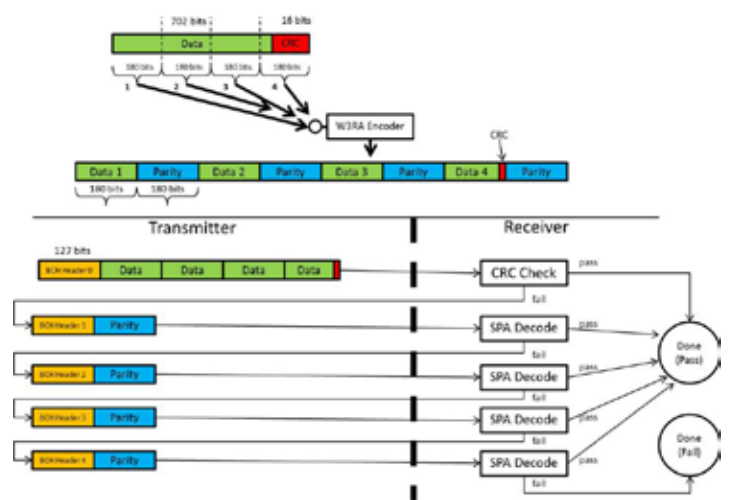

Figure 1. Illustration of how the W3RA encoder and the specialized transmission protocol are combine to create the rate-compatible protocol.

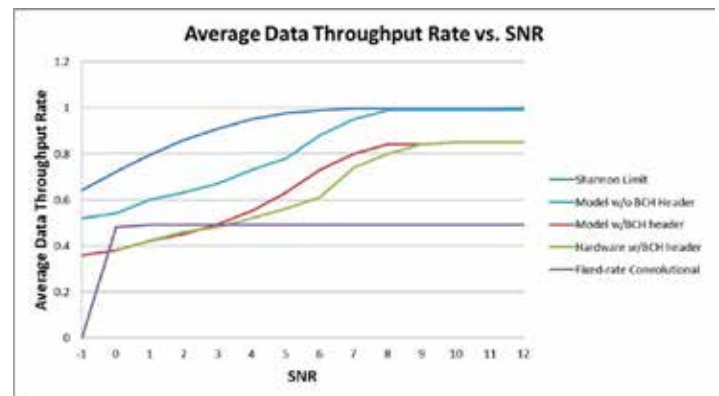

Figure 2. Comparison of the average data through put rate versus SNR. Curves are shown for the theoretical maximum as determined by the Shannon Limit, the model results of encoded data with parity bits but no BCH header, the model results of encoded date with parity bits and the BCH header, the hardware results of the encoded data with parity bits and the BCH header, and the model results for a traditional fixed rate one-half convolutional code.

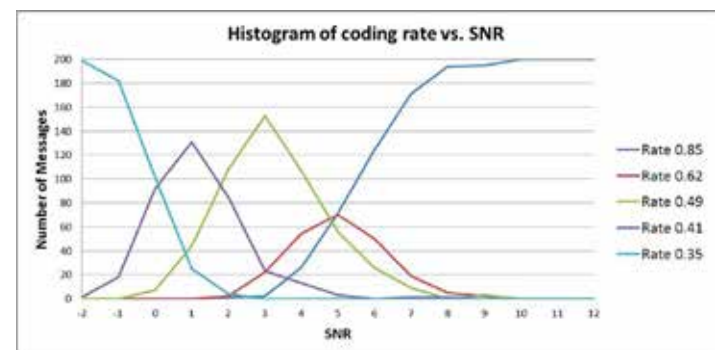

Figure 3. The rate-compatible protocol adjusts the coding rate used to transfer a message depending on the noise in the channel. The figure shows the hardware results of the encoded data with parity bits and the BCH header.

A Quadrature Approach for Non-Gaussian Uncertainty Representation and Propagation

David Palmer
20130784PRD2

Introduction

If you know exactly where something is, and how fast it is going, and what forces affect it, you can make good predictions as to where it will be in the future. However, in the real world, all these things are only approximately known, and you can only estimate that it will be in a certain larger region at some future time. This project looks at predicting satellite collisions, but the techniques being developed are more general and can be applied to any future predictions.

Current standard prediction techniques simplify the uncertainty to regions that are described by spheroids that may be stretched like a football, but not bent like a banana, coiled like a spring, or split into multiple regions. These more complicated uncertainty regions can be explored by simulations.

In more technical terms, this project seeks to develop the next generation of sigma point filters, moving past the Gaussian assumption by developing a Gaussian Mixture Model sigma point transformation and applying the new method to the highly relevant problem of calculating collision probabilities between satellites. LANL's own high-resolution high-frame rate sensor will be used to observe satellites, and LANL's 3-D coupled ionosphere-thermosphere model will be used to accurately propagate the positions low-Earth orbiting satellites while accounting for atmospheric drag uncertainties.

This particular study is focused on space situational awareness, which is a key topic in the Grand Challenge for Sensing and Measurement Science for Global Security. However, more generally, it covers many fields of simulation.

Benefit to National Security Missions

This work represents a new, novel, and ground breaking approach to uncertainty quantification that has applica-

tion across a number of areas in LANL's portfolio. In particular, the development of an accurate and consistent method of characterizing uncertainty is highly relevant for space situational awareness, which is a key topic in the Grand Challenge for Sensing and Measurement Science for Global Security. This project offers an exciting opportunity to further solidify the theoretical underpinning of powerful and well-known methods in nonlinear/non-Gaussian estimation while developing a new and computational efficient technique. Knowing if and when objects in space collide and being able to accurately quantify the uncertainty of such a prediction is in particular relevant for DoD (maintains the space catalog and makes orbital predictions) and NASA (orbital debris office and manned and robotic space asset protection).

Progress

This work investigated a technique called generalized Gaussian cubature where the rules are constructed to integrate a set of functions exactly. Also, this work develops an approach to form generalized Gaussian Cubature rules for Gaussian mixture distributions. First classical quadrature methods for one-dimensional integrals were discussed and an approach to generalize one-dimensional integrals for Gaussian mixture models was shown.

A general method for calculating the quadrature point was investigated. This method was applied to a numerical example where a Gaussian mixture model was considered and two integration rules were compared. The first approach was based on performing the unscented transformation for each Gaussian component to compute the integral. The second approach was based on the methods that utilized sigma points with respect to the Gaussian mixture. It was shown that the method developed for this work outperformed the unscented transformation and provides a means for developing an accurate sigma point transformation for Gaussian mixture models.

Then approaches for multi-dimensional integral were discussed. The generalized cubature approach was selected for solving two problems, multi-dimensional integrals of Gaussian distributions and multi-dimensional integrals of Gaussian mixture distributions. These two problems may be simplified greatly by using the generalized cubature technique along with properties of Gaussian distributions. The problem of solving for the cubature of Gaussian distributions was also greatly simplified by using the multi-dimensional Hermit polynomials. Cubatures were derived for a number of cases and used for both uncertainty propagation and sequential state estimation. Good results were shown with the new methods.

This work also looked at applying these techniques to the problem of light curve inversion for satellite characterization. Progress has been made in this area and good results of been presented at conference. Collaboration has been started with the US Air Force and there are opportunities to expand this collaboration in the future.

Future Work

In the second year this project seeks to further develop generalized Generalized Gaussian Cubature. The postdoc will determine the convergence properties, robustness, and accuracy of the new method. The postdoc will also work with experimental data from a high-resolution high-frame rate sensor developed at LANL. This sensor will provide data of satellite positions that can be used for testing the algorithm and providing a ground truth. Collaboration efforts with the Air Force will continue as the algorithm for light curve processing is developed and Air Force relevant examples are studied.

Conclusion

This post-doctoral fellowship project seeks to develop the next generation of sigma point filters, moving past the Gaussian assumption by developing a Gaussian Mixture Model sigma point transformation. In particular, the development of accurate and consistent method of characterizing uncertainty is highly relevant for space situational awareness, which is a key topic in the Grand Challenge for Sensing and Measurement Science for Global Security. This project is expected to further solidify the theoretical underpinning of powerfully and well-known methods in nonlinear/non-Gaussian estimation while developing a new and computational efficient technique.

Publications

Linares, R., W. Andrew, M. A. Shoemaker, and J. L. Crassidis. Characterization of Inactive Rocket Bodies Via Non-Resolved Photometric Data. 2014. In Advanced Maui

Optical and Space Surveillance Technologies (AMOS) Conference. (Maui, Hawaii, 2014). , p. 0. Maui, Hawaii: AMOS.

Linares, R., and I. IMPACT-TEAM. A Framework for Integrated Modeling of Perturbations in Atmospheres for Conjunction Tracking (IMPACT). To appear in AIAA Book on Space Operations, 2015. Edited by AIAA, .

Linares, R., and I. Impact-Team. A Framework for Integrated Modeling of Perturbations in Atmospheres for Conjunction Tracking (IMPACT). 2014. In AIAA - Space Operations Conference. (Pasadena, CA, 2014). , p. 0. Pasadena, CA: AIAA.

Mehta, P. M., A. Walker, E. Lawrence, R. Linares, D. Higdon, and J. Koller. Modeling Satellite Drag Coefficients with Response Surfaces. 2014. Advances in Space Research. (Oct): 00.

Mixing and Diffusion in Granular Flows

Eli Ben-Naim

20130792PRD2

Introduction

This project aims to understand the complexity of force-carrying contacts in a granular medium, which can often lead to its destabilization (due to external forcing) along unexpected fault lines, as commonly observed in geophysical situations including earthquakes, mudslides, and avalanches. The approach will be twofold. First, a model of how granular materials flows will be developed for the types of conditions encountered in geophysical processes. This is a high-potential scientific problem because, in over three decades of research, this most basic question regarding granular materials remains unsettled. Second, the force-chain network structure of granular materials will be obtained from model experiments, being conducted at Los Alamos, of a granular medium between sheared plates responding to the stimulus of their relative motion. The mathematical techniques of network analysis will be used to better understand the dynamic behavior of the medium under such loads. This is a cutting-edge endeavor because few such laboratory scale experiments and analysis have been carried out previously. Additionally, new algorithms for simulating universal emergent behaviors (clustering, ordering, topology) arising from the interplay between discontinuous granular mixing dynamics and microscopic physics will be developed as part of this project. This is a high-risk undertaking because scaling dynamics of granular materials in geophysical situations to laboratory scale experiments has yet to be demonstrated. Success in the project would imply the ability to extend the scaling concepts that have been so successful in fluid dynamics and aerodynamics to a new area: solid mechanics.

Benefit to National Security Missions

Granular materials are ubiquitous and are found in a host of applied programs. Understanding mixing and flow of granular materials hence has impacts on many applied programs. This project aims at the development of a modeling and simulation capability for describing

mixing and flow of granular materials. The ability to better model mixing of granular matter will impact energy applications such as storage and transportation of materials used in energy applications including coal and bio-fuels. Granular materials tend to segregate according to size, a property that can be an obstacle in manufacturing and transportation processes. This project addresses precise mixing characteristics of granular materials and could lead to the design of optimized container design for improved mixing and more efficient transportation.

The capabilities developed in this project will also be relevant for other DOE programs and needs including waste storage, waste handling and transportation, high explosives, and handling of materials produced in powder form.

Progress

The scientific accomplishments of the project over the last 12 months include the first formulation and prediction of shear dispersion in dense granular flows. The dispersal of a passive solute in a pressure-driven laminar flow, a classical fluid phenomenon, can be described, at long times and far downstream from its injection point, by a cross-sectionally averaged advection-diffusion process in which the mean solute concentration is advected by the mean flow but diffuses with an effective dispersion inversely proportional to the solute's molecular diffusivity. We calculated the effective dispersion for the rapid flow of a dry, cohesionless monodisperse granular material down an incline, assuming that volume fraction variations are negligible in the fully-developed Bagnold profile and that the diffusivity is proportional to the shear rate. This calculation has implications on fields ranging from pharmaceutical powder technology to ecology of geophysical events. For example, understanding granular dispersion is relevant for industrial separation processes such as the drying of powders for the purposes of dehydrating food. On the other hand, the

distribution of debris upon the cessation of an avalanche or landslide can dictate the ecological impact of the geological event. By providing specific analytical results and scaling laws, we advanced the knowledge in these areas.

Second, granular flow in a bi-axial tumbler (rotating container) was formulated and analyzed theoretically. The 3D flow was expressed in terms of a mathematical object called a linked twist map, from which novel types of 3D chaotic dynamics were shown to be exhibited by the granular system. Through a mathematical analysis of the properties of the derived linked twist map, it was possible to make rigorous predictions regarding mixing quality and optimal operating conditions. For example, optimal rotation angles about each of the two axes were derived, such that unmixed regions in the container were minimized. These results have significant implications on the design of devices and processes for mixing of granular materials and pill preparation in the pharmaceutical industry.

Additionally, several problems of fluid flow through granular and heterogeneous porous media were analyzed through the so-called Hele-Shaw analogy. Self-similar solutions were constructed that describe the spreading of very viscous fluids through granular and porous media. These solutions provide asymptotic scaling laws that can be used to determine the extent of spreading of a contaminant in the subsurface or for evaluating geological carbon capture and storage strategies. In the latter case, it is important to know the scaling relationship between the injection rate of supercritical carbon dioxide and its spatial spread in a heterogeneous reservoir or other subsurface structure. Our results provide such scaling laws, whereas most of the current theoretical literature has focused on the homogeneous case.

This project has yielded 6 invited presentations (international conferences, departmental seminars and colloquia such as the Courant Institute at New York University) and 3 contributed presentations (international and regional conferences such as the American Physical Society's March Meeting and its Division of Fluid Mechanics Annual Meeting). In addition, 4 journal publications have appeared in top disciplinary and multidisciplinary journals (Proceedings of the Royal Society A, Journal of Fluid Mechanics, SIAM Journal on Applied Dynamical Systems, Granular Matter) and two more have been submitted for review.

Future Work

We will perform theoretical modeling of the experiments being conducted at Los Alamos on sheared granular media confined between two moving plates. In this coming year, we will further expand our stated focus on geophysics,

connecting to ongoing work at LANL on subsurface transport of particulate materials with applications to hydraulic fracturing. The latter systems consist of granular materials undergoing (potentially large) deformation and shear. A new aspect of this problem, then, is the possibility of comminution (or grinding, breakage, etc). Furthering the ongoing theoretical modeling we are performing, we will incorporate comminution into the models. The models will be analyzed to produce predictions that will be compared against observational data and benchmarked numerical simulations being performed at Los Alamos. Additionally, the theory will be extended to account for nonuniformities of the flow conduits due to fracturing, comminution and other physical effects present in such high-pressure situations. We will also study the effects of grain fragmentation on granular flow, a problem with relevance to geophysical granular flows and earthquake physics.

Conclusion

The outcome of the first part of this work will be improved prediction of rare and destructive seismic events, which have significant implications for society at large. The outcome of the second part of this work will be improved understanding of how localized processes affect structure formation, which can lead to better prediction of dynamics as diverse as percolation in porous medium and spread of infections on networks.

Publications

- Christov, I. C., and P. M. Jordan. On an instability exhibited by the ballistic-diffusive heat conduction model of Xu and Hu. 2014. In PROCEEDINGS OF THE ROYAL SOCIETY A-MATHEMATICAL PHYSICAL AND ENGINEERING SCIENCES. Vol. 4702161 Edition.
- Christov, I., R. Lupetow, J. Ottino, and R. Turman. A Study in Three-Dimensional Chaotic Dynamics: Granular Flow and Transport in a Bi-Axial Spherical Tumbler. 2014. SIAM Journal on Applied Dynamical Systems. 13: 901–943.
- Christov, I., and H. Stone. Shear dispersion in dense granular flows. 2014. Granular Matter. 16: 509.
- Khare, I. C. Christov, and Saxena. Successive phase transitions and kink solutions in $\phi(8)$, $\phi(10)$, and $\phi(12)$ field theories. 2014. PHYSICAL REVIEW E. 90 (2).

Thermodynamics and Information Processing at the Nanoscale

Wojciech H. Zurek
20140667PRD2

Introduction

Sebastian Deffner is an emerging leader in the field of nonequilibrium statistical mechanics (as recognized by the community, and current leaders in the field). As a postdoctoral fellow, he will bring his cutting-edge expertise in nonequilibrium processes to LANL with direct relevance across disciplines. His research program is directly aligned with one of the three main LANL missions: Fostering Energy Security.

Nanodevices running thermodynamic cycles---Deffner's principal area of research---provides optimal ways of converting different types of energy (e.g. thermal into mechanical) and is important for a variety of applications.

The engineering of highly efficient quantum engines and thermodynamic cycles is a low risk, cutting area of research with the potential to advance efficient energy conversion techniques and to impact directly ongoing experimental progress around the world.

There is already significant related interest at LANL. In addition to ongoing research in nanotechnology, current efforts at P-21 (Boshiers's lab), are devoted to the implementation of a superadiabatic quantum piston [A. del Campo, M. G. Boshier, *Sci. Rep.* 2, 648 (2012)], one of the key components to realize the engineered energy systems proposed by Deffner for optimizing energy conversion and use.

Benefit to National Security Missions

Sebastian Deffner will explore laws of thermodynamics as they apply on a nanoscale. At that level thermal and quantum fluctuations become important, and modify optima strategies for extraction of useful work. Efficient acquisition of energy is one of the missions of DOE, and of keen interest to LANL. Moreover, at the level at which Sebastian will explore thermodynamics, information

gained in course of the engine cycle can be comparable to thermodynamic entropy, and its efficient processing using available hardware (which includes quantum information processing) is important. Information processing, including its quantum aspects, is of interest to LANL and DOE.

Progress

As of this report, the postdoc is awaiting to be hired.

Future Work

The main objective of this project research is the development of a coherent framework for the understanding, the design, and the theoretical foundations of nanothermodynamic devices, whose modes of operation allow the implementation of information processing, and which generically operate far from thermal equilibrium. In collaboration with the experimental group of Ferdinand Schmidt-Kaler, we developed only recently the smallest possible quantum heat engine, whose working medium consists of a single trapped ion.

The experimental principle can be extended in two directions: (i) To date, we only studied a single ion trapped in a one-dimensional harmonic oscillator. Optical lattices are, to very good approximation, a network of harmonic oscillators. Thus, the working principles of the one-ion heat engine can be readily generalized to multiple particles evolving in an optical lattice. Such a device would enable the experimental study of the thermodynamic properties of fully controllable multi-particle quantum systems. (ii) In previous research, we also have been interested in the interplay of (quantum) information and thermodynamics. However, how to describe a quantum information reservoir, i.e. a fully quantum mechanical hard disk, and its thermodynamic properties is to date still an open question. To this end, we will be aiming at simple generalizations of the on-ion heat engine towards a minimal quantum Maxwell demon - a perfect device to

study quantum thermodynamics and information theory. We are also planning to investigate fluctuation relations generalizing the statements of the second law of thermodynamics and their consequences on the dynamics of nanodevices. Finally, we will examine, in analogy to effects known from solid state theory, localization effects in optical lattices governing the modes of operation of prospective quantum computers.

Conclusion

We expect our results to have impact on the design of quantum systems in the development of quantum computers, and in the fundamental understanding of nanotechnology experiencing quantum effects. Our research will open new avenues in the fundamental understanding of time-dependent quantum systems operating arbitrarily far from thermal equilibrium, and thereby process information. Highly efficient quantum cycles will be designed.

Shortcuts to Adiabaticity in Quantum Devices

Wojciech H. Zurek
20110736PRD2

Abstract

When a quantum system that is initially in its ground state is subjected to varying external forces or when the interactions between its components change in time, it becomes excited – i.e., it gains energy. In technical terms, it departs the ground state of its Hamiltonian, which corresponds to the total energy of the system. Yet, there are applications where we need to keep the system in the ground state while the forces and interactions vary around it. We can ensure this by making the changes infinitely slowly, which we call adiabatic evolution. But infinite time is not always available. In many applications (e.g., quantum information processing) time is of the essence. “Shortcuts to adiabaticity” were developed to emulate effects of adiabatic evolutions – keep the system in the ground state – while changing the Hamiltonian much faster than adiabaticity would allow. Such shortcuts take the system on an evolution that may seem roundabout (as it involves a more complicated trajectory for the forces and interactions than the obvious variation) but, yet, it can transform the Hamiltonian while keeping the system from getting excited. To this end, we have used the so-called generating function to unify previous approaches. The resulting framework was then used to design shortcuts to adiabaticity for a large class of classical and quantum, single-particle, non-linear, and many-body systems. Applications of our science are long-term, but include better time-frequency standards, a new generation of quantum engines, and nanotechnology refrigerators.

Background and Research Objectives

In the quantum world, adiabaticity refers to the smooth evolution of a system upon slow variations of a control parameter. Implementing an adiabatic dynamics can require an exceedingly long time and is fundamentally impossible in certain many-body systems. Further, bounds to the speed of evolution set limits to quantum technologies (frequency standards in quantum metrology, computational capability of quantum simulators and

computers, efficiency of nanomechanical devices, etc.). This research proposal is aimed at designing shortcuts to adiabaticity (SA), allowing to drive an ultrafast evolution of quantum devices without inducing spurious effects or decreasing their efficiency.

The overall goal of this project was to develop a theory of ultrafast quasi-adiabatic quantum dynamics and work out its applications in a range of platforms of experimental interest.

This was done at three different levels:

Simple quantum systems such as a quantum harmonic oscillator and a two-level atom interacting with a control field. These systems exhibit dynamical invariants, conserved quantities during the time-evolution which can be exploited to drive a non-adiabatic trajectory towards a target state without restriction to adiabaticity nor invoking quantum control techniques. We designed SA for ultrafast compression/expansion, transport and population transfer, and derived new bounds to the speed of evolution robust against external perturbations and coupling to an environment.

Many-body systems: used for quantum simulators and interferometers (either trapped ion chains or cold gases). Here, dynamical invariants are restricted to certain limits (e.g. harmonic coupling in trapped ions, mean-field limit in Bose-Einstein condensates (BEC)) often based on a classical like-description, and may break down upon quantization (an instance of a quantum anomaly). Further, these systems are inevitably driven out of equilibrium across a phase transition. SA could be developed by considering an inhomogeneous driving in space and time.

Quantum Hybrid Systems: with the prospect of outperforming their constituents, such as trapped ions coupled to a reservoir.

Scientific Approach and Accomplishments

Scientific approach: Analytical and numerical description of the dynamics of many-body systems and development of novel control techniques for these systems.

Research: Development of shortcuts to adiabaticity in a wide variety of systems including the targeted systems (trapped ion chains, ultracold gases, spin systems and other many-body systems) for a wide variety of processes including the control of the critical dynamics in phase transitions, defect formation suppression, cooling of trapped atomic gases, superfast transport of many-body systems mimicking adiabatic dynamics, etc. See publication list for details.

Some of the accomplishments in specific projects reported in 2013-2014 include:

- Quantum Simulation of Dissipative Processes without Reservoir Engineering
- Characterization of the Universal far-from-equilibrium Dynamics of a Holographic Superconductor
- Tuning heat transport in trapped-ion chains across a structural phase transition
- Development of classical and quantum shortcuts to adiabaticity for scale-invariant driving
- Design of bent waveguides for matter-waves using supersymmetric potentials and reflectionless geometries
- Characterization of the Universality of Phase Transition Dynamics: Topological Defects from Symmetry Breaking

There have been approximately 20 publications associated with this project including, including five Physical Review Letters, and a Nature communication. A manuscript in Nature Physics is under consideration. The postdoc has received 1122 citations.

Impact on National Missions

Quantum limits to evolution are of fundamental interest in basic science. In addition, SA in I are aimed at achieving higher feeding rates of atomic clocks and interferometers, which will improve the signal to noise ratio and lead to better time-frequency standards. SA in I will also allow for a new generation of quantum engines and refrigerators in nanotechnology.

Improving the preparation of fiducial quantum states in many-body and QHS, II & III, will spur experiments in quantum simulation and computation.

The Theory Division at LANL includes experts on quantum foundations, non-equilibrium phenomena, non-linear and complex systems, providing an ideal atmosphere for carrying out this project.

Publications

Campo, A. del. Shortcuts to Adiabaticity by Counterdiabatic Driving. 2013. PHYSICAL REVIEW LETTERS. 111 (10): -.

Campo, A. del, I. L. Egusquiza, M. B. Plenio, and S. F. Huelga. Quantum speed limits in open system dynamics . 2013. Physical Review Letters. 110: 050403.

Campo, A. del, M. G. Boshier, and A. Saxena. Bent waveguides for matter-waves: supersymmetric potentials and reflectionless geometries. 2014. Sci. Rep.. 4: 5274.

Campo, A. del, M. M. Rams, and W. H. Zurek. Assisted finite-rate adiabatic passage across a quantum critical point: Exact solution for the quantum Ising model. 2012. Physical Review Letters, 109, 115703 (2012) . 109: 115703.

Campo, A. del, T. W. B. Kibble, and W. H. Zurek. Causality and non-equilibrium second-order phase transitions in inhomogeneous systems. 2013. J. Phys.: Condens. Matter. 25: 404210.

Campo, A. del, and M. G. Boshier. Shortcuts to adiabaticity in a time-dependent box . 2012. Scientific Reports. 2: 648.

Campo, A. del, and W. H. Zurek. Universality of phase transition dynamics: topological defects from symmetry breaking. 2014. In Professor Tom Kibble's 80th birthday's Symposium. Edited by Gauntlett, J. P. , p. 31. Singapore: World Scientific.

Deffner, S., C. Jarzynski, and A. del Campo. Classical and quantum shortcuts to adiabaticity for scale-invariant driving. 2014. Phys. Rev. X. 4: 021013.

Masuda, S., K. Nakamura, and A. del Campo. High-fidelity rapid ground-state loading of an ultracold gas into an optical lattice. To appear in Phys. Rev. Lett. .

Nigmatullin, R., A. del Campo, G. De Chiara, G. Morigi, M. B. Plenio, and A. Retzker. Formation of helical ion chains . 2011. LA-UR 11-06244.

Pyka, K., J. Keller, H. L. Partner, R. Nigmatullin, T. Burgermeister, D. M. Meier, K. Kuhlmann, A. Retzker, M. B. Plenio, W. H. Zurek, A. del Campo, and T. E. Mehlstaubler. Topological defect formation and spontaneous symmetry breaking in ion Coulomb crystals. 2013. NATURE COMMUNICATIONS. 4: -.

Ruiz, A., D. Alonso, M. B. Plenio, and A. del Campo. Tuning

heat transport in trapped-ion chains across a structural phase transition. 2014. Phys. Rev. B. 89: 214305.

Sonner, J., A. del Campo, and W. H. Zurek. Universal far-from-equilibrium Dynamics of a Holographic Superconductor. Nature Physics.

Torrontegui, E., S. Ibanez, S. Martinez-Garaot, M. Modugno, A. del Campo, D. Guery-Odelin, A. Ruschhaupt, X. Chen, and J. G. Muga. Shortcuts to Adiabaticity. 2013. ADVANCES IN ATOMIC, MOLECULAR, AND OPTICAL PHYSICS, VOL 62. 62: 117.

Cyber Security of the Smart Grid

Russell W. Bent
20120752PRD2

Abstract

Recent years have seen an increase in interest in a broad class of problems surrounding the cyber security of critical infrastructure systems. In particular, it has been shown that it is possible for malicious entities to manipulate the data provided to control (SCADA) systems and cause operators to make bad decisions. Existing work has focused on building better protection and detection schemes to eliminate this problem. However, this project focused on the premise that malicious entities will be able to gain access to a system despite the best of these efforts. Under this premise, the project delivered algorithms to identify, assess and mitigate cyber intrusions.

Background and Research Objectives

Modern societies and economies are increasingly dependent on services (electric power, natural gas, water, etc.) provided by critical infrastructure systems. These systems are highly complex and are governed by highly non-linear relationships. The complexity makes the systems very difficult to control and operate. Despite the complexity, considerable progress has been made in recent years to improve the control and operation of infrastructure systems. The smart grid initiatives are an example of such advances [1][2]. Smart grid control processes are highly dependent on accurate system state data that is remotely measured and transmitted to control systems via advanced supervisory control and data acquisition (SCADA) systems. The transmission of data represents a point of vulnerability of the smart grid (and other infrastructures) to cyber-attacks.

This project focused on this vulnerability by studying data integrity attacks on SCADA systems that are used for electric power distribution. There were three main focuses of the project.

1. Develop efficient algorithms for identifying the combination of system sensors whose data can be compromised (data integrity attacks) without being

detected by existing security systems.

2. Develop algorithms for calculating consequences of data integrity attacks.
3. Develop algorithms for reducing the impact of data integrity attacks.

Currently, SCADA devices in power systems measure system states such as power injections at substations (buses), power flows at lines and transformers, and voltage values (magnitudes). Historically, such data is measured and transmitted with the expectation that there is noise and error in the measurements and that it does not provide enough information (e.g., voltage phase angles) to completely characterize the system state. As a result, the power engineering community has developed sophisticated techniques to estimate the state of unobserved portions of the power grid and to filter bad data [3]. These techniques are robust to random failures and expected measurement errors in power systems. However, there is concern that it is possible to introduce errors in the data in a coordinated manner that is undetectable by bad data filters [4], i.e. a data integrity attack. In general, an unobservable attack requires the compromise of a large number of sensors and recent work has focused on developing general methods for identifying the worst case scenarios based on the numbers of sensors that are compromised [5][6][7][4]. While these methods are important for assessing system vulnerability, the computational requirements are high and the problems tend to be very difficult to solve.

To address this limitation, we focused on data integrity attacks that require a small number of compromised sensors (focus #1). Such attacks are more realistic because an attacker has limited resources (e.g., time and information) to plan an attack. These types of attacks are referred to as k -sparse attacks, where k is the number of sensors that are compromised [6][4]. We showed that identifying where all attacks for $k=3, 4, \text{ and } 5$ could occur

can be done efficiently [6]. We also developed algorithms to very quickly calculate the worst case economic and physical consequences of k-sparse attacks (focus #2)[8].

After developing solutions to focus area 1 and 2, we then developed algorithms to reduce the impact of k-sparse attacks through redundant measurements. One redundant measurement that helps detect k-sparse attacks is voltage phase angles. Since phasor measurement units (PMUs) directly provide these measurements [9], they can be used for detecting unobservable attacks. Thus, we developed optimization models for optimally placing PMUs to protect systems from formally undetectable k-sparse attacks (focus #3). The PMU placement problem is generally an NP-complete (computationally difficult) problem which is the case here. However, our algorithm was shown to be efficient when tested on a wide range of practical problems.

For completeness, it is important to note that several researchers have focused on similar PMU placement problems based on different criteria for placement. Some of the research seeks to determine the optimal placement of PMUs to improve system observability [10][11][12][13][14][15]. Other research seeks to maximize the amount of mutual information between PMU measurements and power system states [16]. Yet other research [17] considers multi-objective criteria such as observability, cost, importance and security or poses the PMU placement problem in terms of improving state estimation [18][19][16]. Interested readers are referred to [26] for a comprehensive coverage of PMU allocation problems and their solutions. However, our work is the first to develop PMU placement algorithms to protect against k-sparse attacks.

Scientific Approach and Accomplishments

To review, this project produced three main contributions.

- Develop efficient algorithms for determining all possible k=3, 4, and 5 spares attacks.
- Develop metrics for assessing consequence of k-spare attacks.
- Develop mitigation algorithms for reducing the impact of k-sparse attacks.

We now discuss the key accomplishments of each contribution. First, we developed efficient algorithms for identifying combinations of sensors that may be compromised by a malicious actor in a way that is undetectable under existing security schemes. We focused on the realistic setting where an attacker is limited to compromising 3, 4, or 5 sensors (due to the resources needed to compromise sensors). We first identified the specific graph-based

structures that admit such attacks. From a theoretical perspective we proved there is only one graph structure consisting of three sensors, one structure consisting of four sensors, and three structures consisting of five sensors. Figure 1 show the structure of an attack that compromises three sensors. Given these structures, we developed the first polynomial time algorithm to find all substructures in a graph that have these properties [6].

Second, we showed the worst consequence of a compromise occurs at the upper or lower allowable limits for modifying the data a sensor provides. The theoretical result is a proof based on a linear programming approach for bi-level problems. This allows us to compute the worst case outcome in polynomial time [8][20].

Third, to mitigate the consequences of k-sparse attacks, we developed a mixed integer programming approach for determining the minimal number of PMUs required for defense against sets of unobservable attacks. Surprisingly, the models are tractable; this property was verified using empirical studies based on examples drawn from the power engineering literature. Even on networks with thousands of nodes, the problem can be solved in a few CPU seconds [21].

Finally, this project produced prototype software that has implemented all the algorithms discussed above. These algorithms will be integrated into existing critical infrastructure R&D tools and will be used to develop new programs with existing sponsors at DHS and DOE.

The research conducted under this project resulted in numerous accolades. The postdoctoral researcher this project supported is Dr. Annarita Giani. Due to her work, Dr. Giani co-chaired three conferences:

- First International Symposium on Resilient Cyber Systems, part of the Resilience Week, Berkeley, CA, 2013.
- Second International Symposium on Resilient Cyber Systems, part of the Resilience Week, Denver, CO, August 2014.
- Panel Security and Integration at NSF-sponsored workshop on “Control, Computing, and Signal Processing Challenges in Future Power Systems” under the ECCS and CCF programs, Washington, DC, November 2013.

She also served as a project reviewer for the US Department of Energy (office of science), Small Business Innovation Research (SBIR) and Small Business Technology Transfer (STTR) programs (November 2013). Finally she was invited to give numerous seminars including at the digital technology center at the University of Minnesota,

the Airbus Company, and Centre for Maritime Research and Experimentation at NATO, GE Global research, and the Florida Institute of Technology.

Impact on National Missions

This project was connected to Los Alamos National Laboratory's (LANL) Energy Security mission. Specifically, this project fits under the mission's subtopic "Infrastructure reliability and security."

As a nation, the demand for energy has only grown in recent years. This has brought pressure on critical infrastructure, such as electric power grids, to operate more efficiently. As a result, there has been tremendous development and deployment of smart sensors and controls to improve efficiency. A downside of this deployment is that these systems are now more vulnerable to malicious actors as there are more places for such an actor to penetrate and control the system. This project developed the necessary science to identify combinations of sensors whose compromise would impact the system the most. It also developed the science to deploy countermeasures to detect when such compromises occur.

Second, there is strong connection between this project and the information science mission of LANL. In particular, this project produced results in the fields of knowledge extraction, automated discovery, distributed computing, anomaly detection, and smart sensors, as outlined in the Information Science and Technology Grand Challenge.

Finally, this project is directly related to those federal organizations with missions in cyber security including DOE, DHS, DOD, and NIST. The project supported Dr. Giani full time for two years and provided her the opportunity to extend the state-of-the-art in the field. Her work was resulted in the offer of the position of "Lead Complex Systems Scientist" at GE Global Research. In this position, she would be able to transition the project's science into practical deployment that improves the nation's security profile. She is also planning to build collaborations between GE and LANL in these areas.

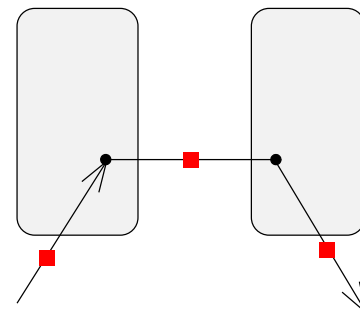

Figure 1. All 3-sparse attacks have this graphical structure. The red squares denote compromised sensors (one sensor is on an edge, and two are at nodes—black circles). To be an unobservable attack, the nodes must be connected to the edge. The gray squares denote the rest of the network. It is important to note that the edge is the only connection between the two sub networks (gray squares). This is also required of a valid 3-sparse attack. 4 and 5 sparse attacks have similar structure.

References

1. Fang, X., S. Misra, G. Xue, and D. Yang. Smart Grid — The New and Improved Power Grid: A Survey. 2012. IEEE Communications Surveys & Tutorials. 14 (4): 944.
2. Farhangi, H.. The path of the smart grid. 2010. IEEE Power and Energy Magazine. 8 (1): 18.
3. Monticelli, A.. Electric power system state estimation. 2000. Proceedings of the IEEE. 88 (2): 262.
4. Liu, Y., P. Ning, and M. Reiter. False data injection attacks against state estimation in electric power grids. 2011. ACM Transactions on Information and System Security. 14 (1): 1.
5. Dan, G., and H. Sandberg. Stealth Attacks and Protection Schemes for State Estimators in Power Systems. 2010. In First IEEE International Conference on Smart Grid. (Gaithersburg, MD, 4-6 Oct. 2010). , p. 214. Gaithersburg, MD: IEEE.
6. Giani, A., E. Bitar, M. Garcia, M. McQueen, P. Khar-gonekar, and K. Poolla. Smart Grid Data Integrity Attacks. 2013. IEEE Transactions on Smart Grid. 4 (3): 1244.
7. Kosut, O., L. Jia, R. Thomas, and L. Tong. Malicious Data Attacks on the Smart Grid. 2011. IEEE Transactions on Smart Grid. 2 (4): 645.
8. Giani, A., R. Bent, M. Hinrichs, M. McQueen, and K. Poolla. Metrics for Assessment of Smart Grid Data Integrity Attacks. 2012. In Power Engineering Society General Meeting. (San Diego, CA, 22-26 July 2012). , p. 1. San Diego, CA: IEEE.

9. Phadke, A.. Synchronized phasor measurements in power systems. 1993. IEEE Computer Applications in Power. 6 (2): 10.
 10. Aminifar, F., A. Khodaei, M. Fotuhi-Firuzabad, and M. Shahidehpour. Contingency-Constrained PMU Placement in Power Networks. 2010. IEEE Transactions on Power Systems. 25 (1): 516.
 11. Huffaker, B., D. Plummer, D. Moore, and K. Claffy. Topology Discovery by Active Probing. 2002. In Symposium on Applications and the Internet. (Nara, 28 Jan - 1 Feb, 2002). , p. 90. Nara: IEEE.
 12. Cai, T., and Q. Ai. Research of PMU optimal placement in power systems. 2005. In ISTASC'05 Proceedings of the 5th WSEAS/IASME International Conference on Systems Theory and Scientific Computation . (Malta, 15-17 Sept 2005). , p. 38. Malta: World Scientific and Engineering Academy and Soc.
 13. Manousakis, N. M., G. N. Korres, and P. S. Georgilakis. Taxonomy of PMU Placement Methodologies. 2012. IEEE Transactions on Power Systems. 27 (2): 1070.
 14. Shewale, R., B. Kethineni, U. Balaraju, S. Bhil, and P. More. Optimal placement of phasor measurement units for power system observability by Heuristic Search Method. 2012. International Journal of Advanced Technology and Engineering Research. 2 (2): 129.
 15. Sodhi, R., S. C. Srivastava, and S. N. Singh. Optimal PMU placement to ensure system observability under contingencies. 2009. In IEEE Power & Energy Society General Meeting. (Calgary, 26-30 July 2009). , p. 1. Calgary: IEEE.
 16. Li, Q., T. Cui, Y. Wang, R. Negi, F. Franchetti, and M. Ilic. An Information-Theoretic Approach to PMU Placement in Electric Power Systems. 2013. IEEE Transactions on Smart Grid. 4 (1): 446.
 17. Linda, O., M. Manic, A. Giani, and M. McQueen. Multi-criteria based staging of Optimal PMU Placement using Fuzzy Weighted Average. 2013. In IEEE International Symposium on Industrial Electronics. (Taipei, Taiwan, 28-31 May 2013). , p. 1. Taipei, Taiwan: IEEE.
 18. Chakrabarti, S., E. Kyriakides, and M. Albu. Uncertainty in Power System State Variables Obtained Through Synchronized Measurements. 2009. IEEE Transactions on Instrumentation and Measurement,. 58 (8): 2452.
 19. Chen, J., and A. Abur. Placement of PMUs to Enable Bad Data Detection in State Estimation. 2006. IEEE Transactions on Power Systems. 21 (4): 1608.
 20. Giani, A., R. Bent, F. Pan, and K. Poolla. Risk Assessment of Unobservable Data Integrity Attacks. 2014. in preparation.
 21. Giani, A., R. Bent, and F. Pan. Phasor measurement unit selection for unobservable electric power data integrity attack detection. 2014. International Journal of Critical Infrastructure Protection. 7 (3): 155.
- ## Publications
- Crespi, V., G. Cybenko, and A. Giani. Attacking and Defending Behavioral Anomaly Detection Methods. 2013. IEEE Journal of Selected Topics in Signal Processing. 7 (1): .
- Garcia, M., A. Giani, and K. Poolla. Partial State Estimation for Electricity Grids. 2013. In 52nd IEEE Conference on Decision and Control, CDC 2013. (Florence, Italy, December 10-13, 2013). , p. 7016 . New York: IEEE.
- Giani, A., E. Bitar, M. Garcia, M. McQueen, P. Khargonekar, and K. Poolla. Smart Grid Data Integrity Attacks. 2013. IEEE Transaction on Smart Grid. 4 (3): 1244.
- Giani, A., O. Linda, M. Manic, and M. McQueen. Known Secure Sensor Measurements Concept and Its Application for Critical Infrastructure Systems. 2013. In Systems and Optimization Aspects of Smart Grid Challenges. Edited by Marco, S., M. Carvalho, P. Pappu, and S. Vijay. Vol. IV, p. . New York: Springer.
- Giani, A., R. Bent, M. Hinrichs, M. McQueen, and K. Poolla. Metrics for Assessment of Smart Grid Data Integrity Attacks. 2012. In 2012 Power And Energy Systems General Meeting. (San Diego, CA, July 2012). , p. 1. : IEEE.
- Giani, A., R. Bent, and F. Pan. Phasor Measurement Unit Selection for Unobservable Electric Power Data Integrity Attack Detection. 2014. International Journal of Critical Infrastructure Protection. 7 (3): 155.
- Giani, A., R. Bent, and F. Pan. Phasor Measurement Unit Placement for Unobservable Attack Detection. 2014. In Eighth Annual IFIP Working Group 11.10, International Conference on Critical Infrastructure Protection. (Arlington, VA, 17-19, March 2014). , p. 1. Arlington, VA: ICCIP.
- Giani, A., and R. Bent. Challenges in Smart Grid Cyber Security. 2013. In 8th Annual Cyber Security and Information Intelligence Research Workshop. (Oak Ridge, TN, Jan. 2013). , p. 1. Oak Ridge, TN: ACM.
- Linda, O., A. Giani, M. Manic, and M. McQueen. Multi-Criteria Based Staging of Optimal PMU Placement Using Fuzzy Weighted Average. 2012. to be submitted to 2013 Power And Energy Systems General Meeting.

Linda, O., A. Giani, M. Manic, and M. McQueen. Multi-Criteria Based Staging of Optimal PMU Placement Using Fuzzy Weighted Average. 2013. In 22nd IEEE International Symposium on Industrial Electronics. (Taipei, Taiwan, 28 May - 31 May 2013). , p. 1. Taipei, Taiwan: IEEE.

Wolpert, D., T. Bhattacharya, R. Bent, J. Neil, A. Kent, and A. Giani. Event-driven non-cooperative games. 2013. Los Alamos National Laboratory, LA-UR-13-22238.

Edge Traffic Monitoring in Computer Networks

Curtis B. Storlie
20120767PRD3

Abstract

Detecting computer network intrusions is an increasingly important task. The current mainstream approach is signature-based detection, which operates similar to anti-virus software and shares many of its strengths as well as its weaknesses. The main shortcoming is its inability, by definition, to detect new attacks, but also its difficulty with relatively minor variations of older ones.

To augment this approach statistical detection approaches are needed. The main such approach is anomaly detection, which has been applied in a variety of fields. However, its application to network intrusion detection has been problematic. Network data sources, e.g. network communications, show considerable variability making the definition of a reliable baseline difficult. While anomalous activity is easy to detect, however, it need not correlate with malicious activity.

Because of these issues, a useful anomaly-based intrusion detector should possess two key properties: (1) It must heavily rely on expert knowledge on how network intrusions unfold; and (2) It should combine multiple activities likely to be enacted by an intruder. The first property helps ensure that deviations in monitored activity correlates with actions taken by intruders, the second is important for reducing noise in any one activity monitor. The main outcome of this project has been the development and implementation of an anomaly detection methodology with these properties. The approach encodes expert knowledge on network intrusions in a descriptive, or non-probabilistic, latent state model. This model describes the possible intrusion states of the networked hosts, and associates the relevant observables to each state. When applied to observed network events, the model identifies all event sequences which are consistent with an attack. These sequences are then scored using anomaly detection, essentially asking the question whether they are likely to have been generated by the same mechanism that governing the historical data. The

approach provides valuable context to network defenders, and applications to real network intrusions show its ability to clearly identify network compromise.

Background and Research Objectives

Computer network intrusions are an increasing concern. News media frequently report on successful and often long lasting intrusions into the networks of large corporations and government agencies. A number of these attacks have resulted in the loss of significant intellectual property.

Detecting network intrusions is clearly important, and there are two basic approaches. The first, and by far the most common, are based on signatures, and operate in a manner similar to anti-virus software. In particular, the approach examines network traffic for patterns of previously known attacks. This could be file names or hashes associated with previous attacks, known communication protocols of malware, byte patterns in files, communication with known bad domains, etc. Though crucial, signature-based detection suffers from many of the same problems as anti-virus software. It is incapable of detecting attacks that don't match one that has already been observed, such as new types of attacks or modifications of older ones.

The second approach to intrusion detection is statistical, namely anomaly-based detection. This approach, first introduced into the computer security literature to detect intrusions into a single host, is meant to work by base-lining historical activity and then flagging deviations from this baseline as potential indications of malicious activity. The application of anomaly detection to network intrusion detection has received considerable attention. However, this application has been problematic. The main reason for this is that network data sources, e.g. network communications, show great variability, making it difficult to define a range of normal activity beyond which only malicious activity is likely to reside.

Put another way, finding anomalies in data on computer networks is all too easy, what is more difficult is monitoring data such that the anomalousness correlates with intrusion related activity.

Be this as it may, anomaly detection is currently the only viable statistical approach to intrusion detection. The reasons for this are: a given network may only have a handful of known intrusions, there are few publicly available data sources on network intrusions, and data on older incidents is less informative due to the evolving nature of attack techniques. Because of this lack of relevant intrusion data and the anomaly-rich nature of network data in general, an anomaly detection approach should possess two characteristics:

1. The detector should rely heavily on expert knowledge on how intrusions typically unfold.
2. The detector should combine data on multiple activities likely to be carried out during an attack.

The second characteristic implies that the multiple features of a given data source should be monitored and correlated, and further that multiple data sources must be used by the detector. The rationale for this point is that while any given activity monitor may contain considerable noise, the combination of multiple monitors of disjoint activity is likely to have considerably greater signal. The first characteristic means that the combination of the monitored activity, as well as which activity to monitor, must be done in a manner consistent with how an attack typically unfolds.

Constructing intrusion detectors that possess properties 1. and 2. is not new, and a substantial amount of research has been carried out on multi-stage intrusion detection via the correlation of multiple network events. However, this work has predominantly been done within the framework of pattern matching of security alerts, for instance via known vulnerability maps (eg attack trees). Such an approach is useful for the correlation of multiple known vulnerabilities, it is less useful for evaluating chains of behavioral events. For this task, scoring the anomalousness of the linked events is important. The main contribution of this project has been to develop and implement such an anomaly detection methodology.

Scientific Approach and Accomplishments

Creating an anomaly detector for combining multiple intrusion related activities requires component level detectors of the activities. This project has produced two articles relating to this topic, namely [1] and [3], while [2] and [4] deal with the topic of combining across multiple activities. To describe the work it is useful to delineate the typical

(targeted) network intrusion.

A phishing email, containing an attachment with, or a hyper-link to, a malicious program often instigates targeted network intrusions. Once activated by the victim, the program is installed on his/her computer, which will attempt to establish a connection to the attacker's machine. If successful, this will establish a communication channel, the Command and Control channel, between the compromised host within the network and the intruder. At this point the intruder is poised to carry out the remainder of the attack, typically gaining access to additional machines on the network, termed lateral movement, and exfiltrating data.

The Command and Control channel associated with an attack will typically lead to an external network connection that is long-lasting and consumes considerable bandwidth. These properties distinguish such a connection from the majority of external connections made from the network, however a sizable number will share similar characteristics. In [3] an approach for correlating suspicious external connections from a host with internal connections made from the host to other machines on the network is described. The rationale is as follows: If the intruder is interactively making connections from the compromised host to others on the network, via the C&C channel, then a correlation will result between the two. In particular, the intruder's commands must first travel across the C&C channel to the initially compromised host and then be forwarded from that host to the other one on the network. A statistical approach for scoring the anomalousness of such external-internal connection pairs is developed, taking into account the correlation of their activity as well as the unusualness of the connections being made. The approach is applied to a real network intrusion, identifying connections made by the intruders.

Similar to the detection of C&C channels by correlating external connections with internal ones, detecting lateral movement by intruders can be done by combining linked and anomalous internal network connections. In [1], the movement of an intruder within the network is considered. The intruder's actions can be viewed as creating a (branching) random walk through the network communication graph, linking together sets of anomalous hosts. A computationally tractable approach for detecting such connected sets of anomalous networked machines is described and applied to a real network intrusion as well as compared to an optimal detector under a known model for an intruder via simulations. The approach successfully flags the activity of related to the intrusion as anomalous, and in the simulation study, performs very similar to the optimal detector.

The different stages of a targeted network intrusion are commonly referred to as the attack chain. Our first attempt at designing a detector making use of all stages in this chain is described in [2]. Here data from a variety of network and host logs is used. The data covers external network connections (via web-proxy logs and DNS logs), internal connections via network logons, email logs for identifying potential phishing emails, as well as host level information such as new programs being executed, program crashes, the use of administrative network command line tools, etc. Careful attention to how to score the anomalousness of the various events is given, as well as to how to combine these scores. In particular, it is illustrated how the clustering of hosts with respect to their sharing of unusual features can provide a strong indicator of network compromise. For instance, if multiple hosts receive the same phishing email, establish connections to the same internet domain and/or execute the same new program, this is highly indicative of an intrusion. Figure 1 shows the anomaly score of the most anomalous host on the network for each day of a 16 day period. This period contained a real network intrusion, which started on day nine, and it is seen that the by far greatest anomaly was observed on this day. The host responsible for this score was known to have been compromised during the intrusion, and thus the detector clearly identified the attack. The main reason for the high anomaly score was that the host both had an anomalous outbound connection, and shared it with a small cluster of hosts that also shared the start of the same new computer program. This computer program was presumably malware installed by the intruders, and the shared outbound connection was their Command and Control channel.

The approach in [2] illustrated the power of combining multiple events for intrusion detection. However, its combination of these events did not make use of their temporal dependence. For instance, during a phishing attack, for a host to become compromised it must first receive and activate the phishing email. Further, for the attackers to perform lateral movement, a Command and Control channel must first be established and be active. A structured and principled way to combine such events is described in [4]. This approach uses a descriptive model for how an intrusion unfolds, describing which intrusion states can be associated with a host and which observables can be emitted in each state as a consequence of the attack. This state model allows key events to lead to state transitions on the host emitting the event, or on some other associated host, allowing the intrusion to spread through the network. When applied to observed data this model generates sequences of events consistent with an intrusion. These sequences can be represented using a tree structure, the

event-tree, and an approach for scoring the events of the tree is developed.

To illustrate our approach, data from a period containing a known network intrusion was used. Figure 2 shows the daily network anomaly score generated by the approach over a 14 day period, first scoring each networked host according to the intrusion model, and then scoring all outbound destinations using the anomaly scores of their associated hosts form the score. It is seen that day 21 produced the highest score, and further investigation showed this to correspond to a domain used by the intruders. The event-tree associated with the most anomalous host (with traffic to the attack domain) is given in Figure 3. The attack model used here contained three states: Uncompromised (U), Compromised (C), and Remotely controlled (R). A host can go from state U to state R by initiating a Command and Control channel, the observable of which is the start of an external connection to a domain to which no prior traffic has been observed. While in state R, i.e. while the Command and Control channel is active, the intruder can install malware and initiate network logons, the latter of which will lead to transitions to the destination hosts of the logons, transitioning these from U to R. When the remote connection ends the host transitions from R to C. In Figure 3 it is seen that host 'h' initiates three external connections that might be Command and Control connections. Two of these are not associated with further events, however the one depicted in the middle shows multiple program installations (the arrows emitted from box 'INSTALL'), and multiple logon failures (the arrows emitted from box 'NFAIL'). Further, two network logons are initiated from this host (the arrows from box 'NLOG'), these logons lead to potential state transitions of hosts 'h*' and 'h**', the former of which subsequently logged on to a different host 'g'.

The usefulness of the approach is witnessed both by its ability to identify the known network intrusion, by assigning the associated hosts high anomaly scores, but also that it leads to an easily interpretable depiction of the events leading to that score. This latter property is crucial for operational use, where providing context to the network defender is important such that he can assess what is likely a false positive, and what is worthy of further investigation.

Impact on National Missions

Network and informational security is clearly of vital national interest. An important aspect of this is the ability to quickly detect computer network intrusions. Current approaches to this problem, i.e. signature based detection, is vital and the importance of maintaining up-to-date signatures is key. However, statistical/behavioral detection has a crucial role to play, because it is the only approach

capable of detecting attacks that do not generate patterns that match the signature database, such as attacks using new techniques or significant variations of older ones. The application of anomaly detection to network intrusion detection currently has a long way to go before it becomes useful for operational security. The state of the art simply is too noisy to be useful. This work has identified two key features of a useful anomaly detector, namely the need to make explicit use of expert knowledge on intrusions, and the combination of multiple behavioral indicators. The applications of the developed methodology do show considerable promise, and further development in this direction is vital to move anomaly detection into the realm of practice.

Outbound destinations

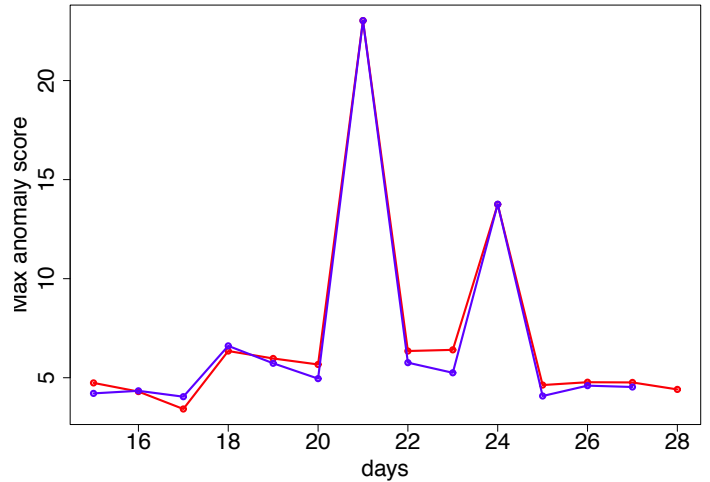

Figure 2. The figure shows the network anomaly score associated with outbound connections for a 14 day period containing a real network intrusion. The red line corresponds a data-window of two days, while the blue line corresponds a data-window of a single day.

Combined anomaly score

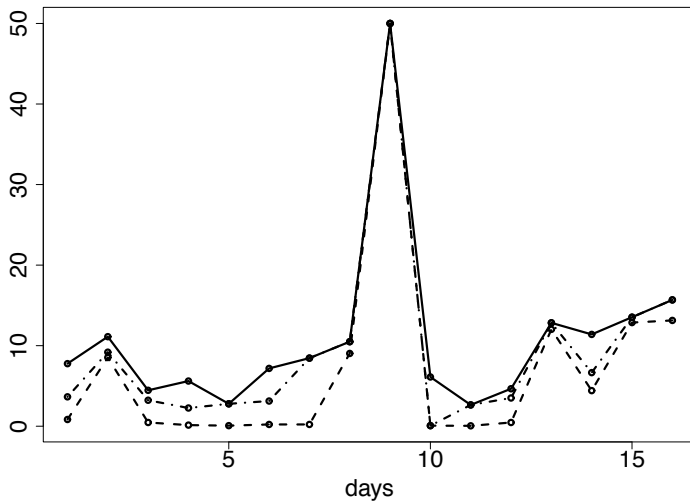

Figure 1. The figure shows the network anomaly score over a 16 day period containing a real network intrusion. The solid line corresponds the anomaly score combining all monitored activity, the dashed line corresponds the score with internal network activity removed, while the dashed dotted lines correspond the anomaly score with both internal network activity and anomaly scores on outbound connections removed.

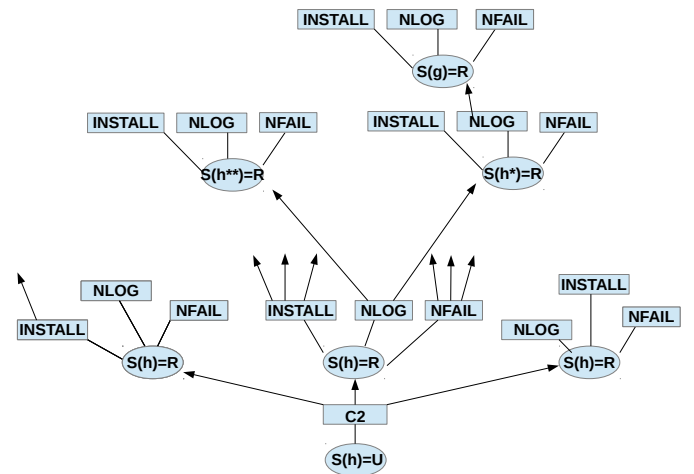

Figure 3. The figure shows the event tree of an anomalous host identified during an attack. The ovals represent possible states of a host, with $S(h)$ denoting the state of host 'h'. The boxes represent possible observable events associated with a given intrusion state of a host, and arrows represent actually observed events.

References

1. Sexton, J., C. Storlie, J. Neil, and A. Kent. Graph structured hypothesis testing for network intrusion detection. 2013. Resilient Control Systems (ISRCs), 2013 6th International Symposium on .
2. Sexton, J., C. Storlie, and J. Neil. Attack chain detection. 2014. Submitted .
3. Sexton, J., and C. Storlie. Internal stepping stone detection. 2014. Submitted for LAUR..

-
4. Sexton, J.. Anomaly detection of multi-stage network intrusions. 2014. Submitted for LAUR..

Publications

Sexton, J.. Anomaly detection of multi-stage network intrusions. 2014. Submitted for LAUR..

Sexton, J., C. Storlie , J. Neil, and A. Kent. Graph structured hypothesis testing for network intrusion detection. . 2013. In Resilient Control Systems (ISRCs), 2013 6th International Symposium on . (San Fransisco , 13-15 Aug. 2013). , p. 86 . San Francisco, CA : IEEE.

Sexton, J., C. Storlie, and J. Neil. Attack chain detection. 2014. Submitted..

Sexton, J., and C. Storlie. Internal stepping stone detection. 2014. Submitted for LAUR..

Extending the Time-Scale of Protein Simulations using Accelerated Molecular Dynamics Techniques

Arthur F. Voter
20130777PRD1

Abstract

In this project we make advances towards applying the parallel replica dynamics (ParRep) method to a different class of system, namely the dynamics of protein folding. In short, ParRep advances an infrequent-event system rapidly from state to state by parallelizing time over many replicas of the system in each state. A recent theoretical advance in the understanding of the generality of ParRep, allowing for more general state definitions, opens the possibility of effective application to complex systems such as proteins, something that was previously thought to be impossible in most cases. This new approach was first tested on a small model peptide system, the alanine dipeptide, for which the exact dynamics are known, and then extended to a bigger system, mutated poly-alanine. Preliminary results for the two systems are shown.

Applying this new methodology will lead to a substantial payoff, as most protein folding and function takes place on timescales longer than are accessible with direct molecular dynamics. Moreover, this methodology can be transferred well to study the dynamics in other complex and soft-matter systems important in nanotechnology, energy conversion and alternative energy generation.

Background and Research Objectives

The overall goal of this project is to develop a viable methodology for application of the parallel-replica dynamics method to protein folding. Success in this project will impact biochemistry, as timescales for important protein dynamics, DNA dynamics, membrane function, etc., are beyond the reach of standard molecular dynamics (MD). Success will also influence other fields where soft-matter or complex dynamics are important, as accurate atomistic evolution of these systems on long timescales beyond about one microsecond is currently impossible. Examples include heterogeneous catalysis and processing steps in surface coatings for solar cells or semiconductors.

Parallel-replica dynamics (ParRep) is a method originally developed at LANL by Art Voter in 1998 [1]. The basic idea is to make use of the fact that a system stays in a state for a long time until an infrequent event occurs and the state is left. The time spent in this state can be parallelized by running multiple replicas and hence more simulation time can be accumulated more quickly in the same real time. It can be shown [1] that the rate at which the system leaves the state is the same as in the case of a brute force (i.e., direct MD) simulation. On the down side, at the beginning of the parallel stage the replicas have to be dephased, meaning a certain part of the simulation has to be spent to bring the replicas into statistically independent configurations. This dephasing time is not part of the accumulated simulation time.

Recently it has been shown [2] that the states can be defined arbitrarily, making it actually possible to apply ParRep to protein systems, and also proven that the accuracy of ParRep depends on the length of the dephasing step. The proof unveiled that ParRep's dephasing procedure prepares a quasi-stationary distribution, which leads to the fact that the distribution of the escape time is exponential and hence rates between states are correct. Even though states can be defined arbitrarily without corrupting the accuracy of ParRep, which is a powerful concept, speed-up over standard MD can only be achieved if the states are deep enough for the escapes to be infrequent. Otherwise the overhead of dephasing will dominate ParRep and no significant speed-up will occur.

Scientific Approach and Accomplishments

In the first part of this project we investigated the alanine dipeptide system using standard MD and analyzed the outcome to verify the correct distribution of escape times. Exploratory simulations on the alanine dipeptide system (see Figure 1 for sketch) have been performed using the GROMACS code. Tens of thousands of trajectories were initiated from a single geometry, and

the escape time distribution was determined for various definitions of the state boundary, as defined by rectangular regions in the ϕ - ψ (Ramachandran) plot. As predicted by the quasi-stationary distribution theory, after a suitable dephasing time, the decay of the population from the defined state becomes cleanly exponential (see straight line in Figure 2). Thus, as anticipated, this system and this type of state-boundary definition would allow treatment with parallel replica dynamics to accelerate the rate of state-to-state transitions. However, one aspect that is less than satisfactory for using this as a model system is that the average escape time from the deepest state is not long enough to get significant parallelization gain.

We then looked at the poly-alanine class of systems, which are known to form helices. We did a couple of long standard-MD runs and observed that the helix forming and rupturing happens in a rather unstructured way and on very short timescales. With that in mind we decided to proceed to the class of mutated poly-alanines [3], which was also studied at LANL in the past [4].

We ended up choosing 9A1K as a test system (see Figure 3), which is a 10-fold poly-alanine where the 7th alanine is replaced by a lysine. After a standard setup procedure, which involved minimization and equilibration, we did 64 long standard MD simulations at 4 different temperatures (200K, 250K, 300K and 350K) in vacuum to explore the angle space, end-to-end distance and helical content. In trajectories at 300K we identified 8 states that were metastable. We then ran about 64,000 simulations on these 8 states and analyzed their angle distributions. Initial condition number 4 (see Figure 4 for a trajectory entering the state and Figure 3 for the actual state conformation) had the most distinguished transition between states. From the angle distributions we learned that the ψ and ϕ angles at the 7th amino acid are the ones to separate the states.

Knowing that we will need an adequate number of runs to get accurate statistics, we implemented a parallel run environment. GROMACS can make use of domain decomposition parallelization as well as force decomposition parallelization. For these small vacuum simulations the only useful option is force decomposition, but in this case the overhead of the parallelization eats up most of the speed-up and hence we choose to trivially parallelize the simulations.

We then built a large database of simulations starting from initial condition number 4. Currently we have about 250,000 simulations in the database. To handle this many simulations we implemented a parallel analysis framework as data from different clusters has to be gathered and averaged. Without parallel data analysis this wouldn't be

possible in a reasonable time.

With this capability we measured the escape time from the initial state for different sizes of the state, meaning different boundaries in the ψ and ϕ angle space of the 7th amino acid. First of all we found that bigger states have a longer escape time, which is a good cross-check for our analysis, but not surprising. We found the distribution of escape time to be exponential, which is in agreement with the quasi-stationary distribution theory. In addition we partitioned the escapes into several directions. This technique can be used to estimate the dephasing time by recognizing the fact that after some initial draining the escape rate should be the same in all directions (see Figure 5 for the actual distribution). However, to do this accurately a lot of statistics are needed.

In summary we studied two systems and checked the distribution of escape times and the agreement with theory. We learned that the choice of state partitioning is the key factor in determining the speed-up that can be gained with ParRep. Determining the dephasing time accurately and in a general way remains an open task. Technically we implemented a parallel run and analysis framework for GROMACS. These GROMACS capabilities have been used during the CNLS's q-bio 2013 summer school to educate students. A database of simulations has been created and can be used in the future for in-depth analysis.

It is important to point out that this project ended after 13 months, essentially a year early, due to the conversion of the associated PostDoc into a different division.

Impact on National Missions

The accurate description of processes such as protein folding, protein function, drug function, etc., on biologically relevant timescales is a long-standing problem. This project aimed to develop a methodology to extend the accessible simulation timescale for these types of processes. Similar approaches could impact not only bioscience, but other areas where complex or soft-matter dynamics are important. Such a capability could be extremely useful to understand active site protein chemistry, which could lead to the design of bio-inspired catalysts with high efficiency and selectivity. This specifically addresses a key mission of the Physical Biosciences program of the Chemical Sciences, Geosciences, & Biosciences (CSGB) Division of the Basic Energy Science Office. Future work in these directions could also lead to improved understanding of bio-chemical reactions inside the cell that could be used for energy-related applications, which is also an area of interest to the CSGB.

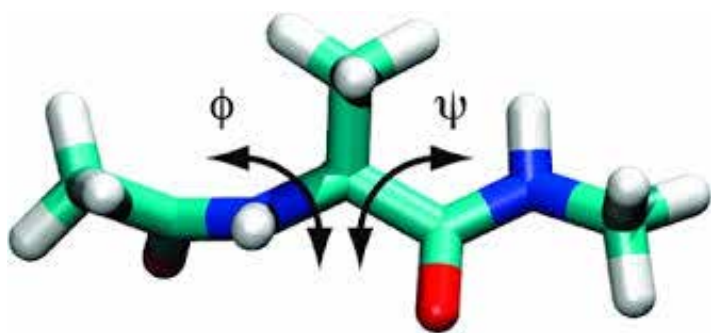

Figure 1. Alanine dipeptide molecule, indicating the Ramachandran angles.

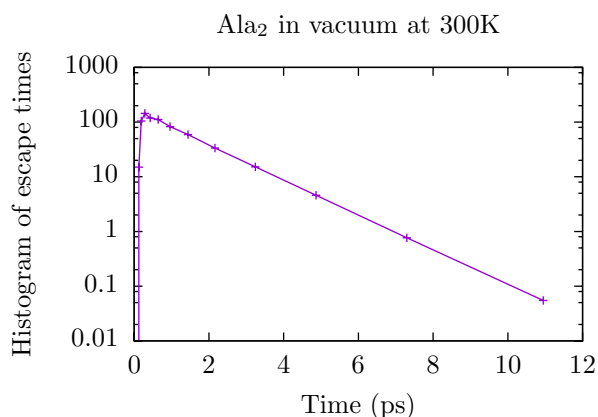

Figure 2. Histogram of escape times for alanine dipeptide in vacuum at $T=300K$.

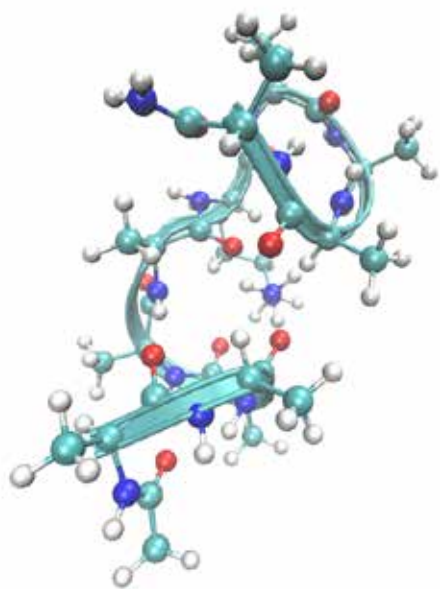

Figure 3. State number 4 of the 9A1K system (10-fold poly-alanine where the 7th alanine is replaced by a lysine).

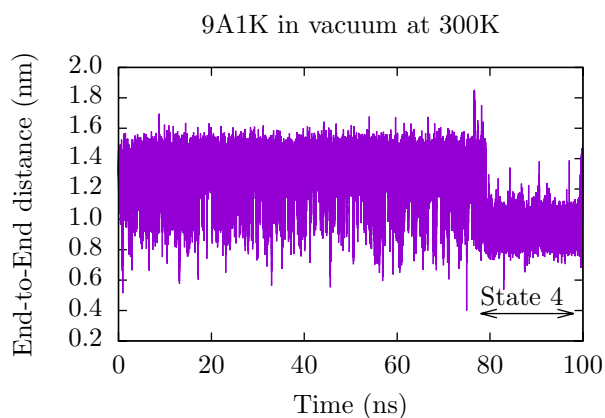

Figure 4. Time series of 9A1K system, showing transition to state 4 at ~ 70 ns.

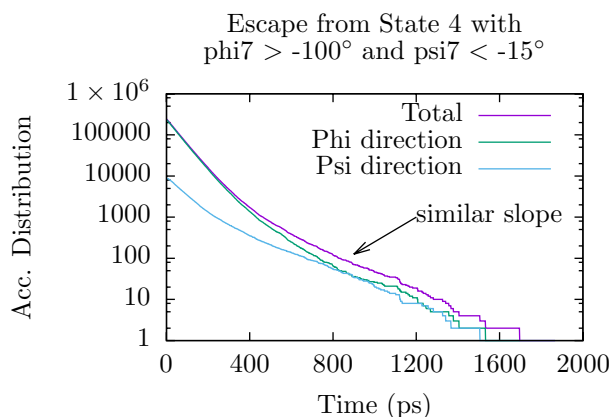

Figure 5. Distribution of escape times for two different escape pathways out of state 4 of the A19K system. At ~ 800 ps, the two curves (blue and green) are seen to become exponential, and with the same slope, indicating that dephasing has been achieved and escapes are occurring from the QSD.

References

1. Voter, A. F. Parallel replica method for dynamics of infrequent events. 1998. *Physical Review B*. 57 (22): 13985.
2. Bris, C. Le, T. Lelievre, M. Luskin, and D. Perez. A mathematical formalization of the parallel replica dynamics. 2012. *Monte Carlo Methods and Applications*. 18 (2): 119.
3. Vila, J. A., D. R. Ripoll, and H. A. Scheraga. Physical reasons for the unusual α -helix stabilization afforded by charged or neutral polar residues in alanine-rich peptides. 2000. *Proceedings of the National Academy of Sciences*. 97 (24): 13075.
4. Garcia, A. E., and K. Y. Sanbonmatsu. α -Helical stabilization by side chain shielding of backbone hydrogen bonds. 2002. *Proceedings of the National Academy of*

Sciences. 99 (5): 2782.

Publications

Bevc, S., C. Junghans, K. Kremer, and N. Praprotnik. Adaptive resolution simulation of salt solutions. 2013. *New Journal of Physics*. 15: 105007.

Junghans, C., D. Perez, and T. Vogel. Molecular Dynamics in the Multicanonical Ensemble: Equivalence of Wang-Landau Sampling, Statistical Temperature Molecular Dynamics, and Metadynamics. 2014. *Journal of Chemical Theory and Computation*. 10 (5): 1843.

Nagarajan, A., C. Junghans, and S. Matysiak. Multiscale Simulation of Liquid Water Using a Four-to-One Mapping for Coarse-Graining. 2013. *Journal of Chemical Theory and Computation*. 9: 5168.

Rouet-Leduc, B., K. Barros, E. Cieren, V. Elango, C. Junghans, T. Lookman, J. Mohd-Yusof, R. S. Pavel, A. Y. Rivera, D. Roehm, A. L. McPherson, and T. C. Germann. Spatial adaptive sampling in multiscale simulation. 2014. *Computer Physics Communications*. 185 (7): 1857.



Materials for the Future

Empowering the Expert: Machine Learning with User Intelligence

Reid B. Porter
20130013DR

Introduction

Scientists and intelligence analysts are very good at understanding and exploiting the specialized datasets with which they work; the problem is that there is too much of this data for them to look at. Data processing tools help to clean up, filter and identify the most relevant subsets of data, but recent developments in machine learning have indicated that there is a grand opportunity to dramatically enhance the efficiency and accuracy of this process, by involving the user in a more interactive dialog.

Traditional machine learning employs a fixed set of labels, supplied up-front by the user, to optimize data processing tools before they are applied to a larger dataset or data archive. This approach has proven successful both in theory (rigorous proofs) and in practice (commercial applications). Machine learning with user intelligence pushes the state of the art in two directions.

From up-front learning to interactive learning

Traditional machine learning tools stop when the human steps in. This means the expert is still the bottleneck in data exploitation: spending too much time in tedious and repetitive post-processing tasks and not enough time on validation and research. Machine learning with user intelligence starts when the human steps in, and tools are a force multiplier, where the user's intelligence is the force to be multiplied, not an expense to be minimized.

From label learning to relational learning

Machine learning with user intelligence formalizes the interactive dialog with relational objects, stated in terms of motifs, clusters, alignments, matches and other generalizations of standard labels. By providing additional interface "bandwidth" between the domain expert and the data processing tool (and thus creating a better expression of the dialog in terms of graphical models), higher quality associations are produced, and more ef-

fective tools can be built.

Benefit to National Security Missions

This project empowers scientists and defense analysts to exploit specialized data in less time, and with greater accuracy, both by automating tedious and repetitive tasks and by enabling them to focus on validation and higher-level objectives. This general capability will be valuable to a large number of government agencies and missions. This project will also develop specific tools for (at least) two LANL applications:

Nuclear Material Forensics

Experts draw upon a vast understanding of the nuclear fuel cycle to quantify spectroscopy images, but they spend weeks each year manually correcting tool estimates of particle and grain boundaries. This project's image quantification advances will be valuable to DOE, DHS, and DOD.

Cyber-security

Analysts draw upon a deep understanding of the computer network as well as attacker behavior to determine if anomalous network traffic requires further investigation. However there is simply too many anomalies for analysts to perform even the most cursory triage. This project's cyber-security tools will be valuable to DOE, DHS and DOD, in particular for the protection of the NNSA complex itself.

Progress

In March of this year we hosted a mini-workshop on Interactive Machine Learning as part of the project appraisal. The two day event attracted 8 external speakers from industry (Google, Microsoft Research), academia (Caltech, Cornell, CMU, Indiana and UCSC) and government (JPL) who are at the forefront of Interactive Machine Learning. All participants were engaged, and we believe the event was productive and successful. Specifically, it helped our team develop a new collaboration

with Indiana University in the area of Interactive Relational Learning. We are hosting an Indiana University PhD student in this area over the summer, and he is helping apply Indiana's expertise in these methods to LANL applications.

In other work, progress continued along the two main technical thrusts that we articulated in our roadmap / review article on Interactive Machine Learning that was published at the start of this year. We call the first thrust the 'Training Dialog', and it moves us from up-front learning to interactive learning (as described in the project description). Progress included:

- Presenting our experiments comparing 'user-in-the-loop' training to traditional batch learning at the Visualization and Data Analysis Conference (VDA-2014), and received a Best Paper award. An extended version of this paper is in preparation for the Journal of Information Visualization.
- Developing a framework for Matched Pair machine learning that can potentially expand the range of tools and applications for Interactive Machine Learning and showed that in a plume detection application learning in the deployed environment outperformed learning offline.
- Deriving and implementing a set of learning methods, which unlike popular methods, solve supervised classification, robust (min-max) classification, Neyman-Pearson detection, anomaly detection and hemi-supervised classification with the same time and memory complexity. We used these methods to develop a hemi-supervised Neyman-Pearson detector to find encrypted chat traffic in cyber network traffic. The resulting detectors significantly outperformed traditional signature based detectors on real computer network traffic. In the next year we plan to use these methods within a prototype interface we have developed with the LANL Cyber-security team for user-in-the-loop triage of network traffic anomalies.

We call the second thrust the 'Training Vocabulary, and it moves us from label learning to relational learning (as described in the project description). Progress included:

- Developing a new mechanism to incorporate expert knowledge into Bayesian network structure learning algorithms. This was presented at the Los Alamos Postdoc Research Day and received a Best Poster Award
- Developing a new graph-based optimization technique for finding optimal epitope coverage in aligned sequences, and presented it at the Conference on Data Analysis, where we also received a Best Poster Award.

- Continued development of theory and algorithms for the interactive image quantification prototype. We identified and formalized the interactions of most interest, which we call Semantic Interactions and they include: Labeling, Grouping, Ungrouping and Matching. We extended our learning to merge (group) algorithms from Year 1 into two new algorithms that enable us to learn from Labeling and Ungrouping. We call these algorithms Deep Max Min Networks and Deep Segmentation Networks respectively. Initial results were presented at our March workshop and publications are in preparation. We also recently made a new connection between supervised classification and perfect matchings which may help us develop new methods for the 'Matching Interaction'.
- Continued theoretical advances on Loopy Belief Propagation algorithms. Specifically we developed a Bootstrap Belief Propagation method that is exact for perfect matchings on bipartite graphs, and bounded for more general graphs.
- Applied Loopy Belief Propagation to a number of image problems relevant to the Labeling interactions, and compared its performance to a number of other approximate inference methods including Pseudo-Likelihood and Mean-Field approaches.

Building on the LDRD we secured new projects from DHS DNDO and the Intelligence Community. Both of these projects involve specialized analysts (in the DNDO project, chemists and microscopists, and in the IC project, non-proliferation and arms control experts). The methods we are developing for interactive image quantification and interactive network alarm triage are directly applicable to the DNDO and IC analysts respectively, and we are identifying opportunities to develop these programs further.

Future Work

Task: Develop methods for structured output prediction.

Goal: Efficient and general purpose learning algorithms to support increased user interaction.

Task: Develop interactive learning strategies for Graphical Models.

Goal: Algorithms that are robust to missing data and/or limited training examples.

Task: Identify and develop efficient strategies for combining inference and learning.

Goal: A better understanding of the accuracy and robustness of interactive learning with graphical models.

Task: Implement initial tools for image quantification and cyber-security applications.

Goal: Software that domain experts can use on practical datasets and an experimental platform for the project.

Task: Develop synthetic and benchmark experimental frameworks for interactive learning.

Goal: An ability to evaluate the accuracy and utility of tools for practical applications at various levels of interaction.

Conclusion

Our goal is to provide a general framework for data processing tools that directly targets the post-processing bottleneck. We emphasize graphical models in this development, as these provide a balance of rigor and flexibility on the learning front and domain adaptability on the interactivity front. An additional goal is to develop new tools, optimized for specific applications in nuclear material forensics and cyber-security, where there is a critical need to make data exploitation more accurate and more efficient.

Publications

- Burr, T., and A. Skurikhin. Conditional Random Fields for inverse problems in structured data. 2014. Encyclopedia of Information Science and Technology, 3rd Edition Encyclopedia of Information Science and Technology, 3rd Edition.
- Burr, T., and A. Skurikhin. Pseudo-likelihood inference for Gaussian Markov Random Fields. 2014. Statistics Research Letters Statistics Research Letters. 2 (3): 63.
- Chertkov, M., A. E. Gelfand, and J. Shin. Loop Calculus and Bootstrap-Belief Propagation for Perfect Matchings on Arbitrary Graphs. Presented at International Meeting on 'Inference, Computation, and Spin Glasses'. (Sapporo, Japan).
- Gelfand, A. E., J. Shin, and M. Chertkov. Belief Propagation for Linear Programming. Presented at IEEE International Symposium on Information Theory (ISIT). (Istanbul, Turkey).
- Harvey, N., and R. Porter. User-Driven Sampling Strategies in Image Exploitation. Presented at IS&T / SPIE Visualization and Data Analysis VDA'2014. (San Francisco).
- Harvey, N., and R. Porter. User-Driven Sampling Strategies in Image Exploitation. 2014. Information Visualization Information Visualization.
- Johnson, J., D. Oyen, P. Netrapalli, and M. Chertkov. Learning Planar Ising Models. Presented at In revision.
- Loxley, P.. Learning dictionary statistics from natural images. Presented at Neural Computation.
- Matteoli, S., M. Diani, and J. Theiler. An overview of background modeling for detection of targets and anomalies in hyperspectral remotely sensed imagery. 2014. Selected Topics in Applied Earth Observations and Remote Sensing (JSTARS) Selected Topics in Applied Earth Observations and Remote Sensing (JSTARS). 7: 2317.
- Odom, P., T. Khot, R. Porter, and S. Natarajan. Knowledge Based Probabilistic Logic Learning. Presented at AAAI'15..
- Oyen, D.. Discovery of Bayesian network structure from data and prior knowledge (poster). Presented at Conference on Data Analysis (CoDA). (Santa Fe, NM).
- Oyen, D.. Discovery of Bayesian network structure from data and prior knowledge (poster). Presented at LANL Post-doc day.
- Oyen, D., A. Niculescu-Mizil, R. Ostroff, and A. Stewart. Controlling the Precision-Recall Tradeoff in Differential Dependency Network Analysis. 2014. Nature Medicine Nature Medicine.
- Oyen, D., and T. Lane. Bayesian structure discovery of multitask Bayesian networks. 2014. Knowledge and Information Systems Knowledge and Information Systems.
- Oyen, D., and T. Lane. Bayesian discovery of multiple Bayesian networks via transfer learning. Presented at IEEE International Conference on Data Mining.
- Porter, R., J. Theiler, and D. Hush. Interactive Machine Learning in Data Exploitation. 2013. Computing in Science and Engineering Computing in Science and Engineering. 15 (5): 12.
- Porter, R., N. Harvey, and C. Ruggiero. Investigation of Segmentation Based Pooling for Image Quantification. Presented at IS&T / SPIE Image Processing: Machine Vision Applications VII. (San Francisco).
- Porter, R., S. Lundquist, and C. Ruggiero. Learning to Merge: A New Tool for Interactive Mapping. 2013. In Algorithms and Technologies for Multispectral, Hyperspectral, and Ultraspectral Imagery XIX.
- Porter, R., and B. Zimmer. Links Between Binary Classification and the Assignment Problem in Ordered Hypothesis Machines, . Presented at IS&T/SPIE Electronic Imaging. (San Francisco).
- Porter, R., and C. Ruggiero. Data Integration and Entity Resolution: Challenges and Opportunities for Nonproliferation and Arms Control. Presented at

Information Analysis Technologies, Techniques and Methods for Safeguards, Nonproliferation and Arms Control Verification. (Portland, Oregon).

Knowledge Discovery and Data Mining
Knowledge Discovery and Data Mining.

Sentz, K., and F. Hemez. The Future of Intelligent Systems for Safeguards, Nonproliferation, and Arms Control Verification. Presented at INMM Information Analysis Technologies, Techniques and Methods for Safeguards, Nonproliferation and Arms Control Verification. (Portland, OR).

Sentz, K., and S. Ferson. Natural Language of Uncertainty: Numeric Hedge Words. 2014. International Journal of Approximate Reasoning International Journal of Approximate Reasoning .

Shin, J., A. E. Gelfand, and M. Chertkov. A Graphical Transformation for Belief Propagation: Maximum Weight Matchings and Odd-Sized Cycles . Presented at NIPS 2013. (Lake Tahoe, NV, USA).

Skurikhin, A. N.. Learning tree-structured approximations for Conditional Random Fields. Presented at IEEE Applied Imagery Pattern Recognition Workshop.

Theiler, J.. Transductive and Matched-Pair Machine Learning for Difficult Target Detection Problems. Presented at SPIE 9088 (90880E).

Theiler, J.. By Definition Undefined: Adventures in Anomaly (and Anomalous Change) Detection. Presented at 6th IEEE Workshop on Hyperspectral Image and Signal Processing: Evolution in Remote Sensing (WHISPERS).

Theiler, J.. Spatio-spectral anomalous change detection in hyperspectral imagery. Presented at 1st IEEE Global Signal and Information Processing Conference .

Theiler, J.. Matched-pair machine learning . 2013. TechnometricsTechnometrics . 55: 536.

Theiler, J., and B. Korber. Epigraph: optimal epitope coverage for aligned sequences (poster). Presented at Conference on Data Analysis (CoDA). (Santa Fe, NM).

Vaish, R., S. Lundquist, R. Porter, and J. Davis. Crowd-sourcing bounding box annotations for computer vision . . Presented at HCOM 2013: Human computation. (Palm Springs, California).

Wallstrom, T.. Clustering Algorithms for HIV Antibodies (poster). Presented at Mini-Workshop on Interactive Machine Learning. (Los Alamos).

Wolpert, D., and D. Rajnarayan. Using Machine Learning to Improve Stochastic Optimization. Presented at Late breaking papers in AAAI.

Zimmer, B., and R. Porter. Hemisupervised Expectation maximization for rare category detection . 2014.

Fighting Carbon with Carbon: All-Carbon Nanomaterial Photovoltaics

Stephen K. Doorn
20130026DR

Introduction

Our pioneering development of graphene oxide and compositionally-defined bundles of carbon nanotubes as new optical materials has revealed new photophysical behaviors that indicate these carbon nanomaterials possess many properties of ideal light harvesters for thin-film photovoltaic applications. These benefits include more efficient light absorption than molecular chromophores, tunability of optical and electrochemical properties to match the solar emission spectrum and allow optimization of interfacial charge flow between other device materials, and extremely efficient photogeneration of long-lived free charges available for collection as electrical power. Our findings create a compelling opportunity to create new photovoltaic device types. These will be designed to specifically exploit the potential our newly-introduced materials hold for overcoming current bottlenecks in solar-energy harvesting performance imposed by the limitations of currently used light-harvesting chromophores. By project end we will harness these properties within functioning photovoltaic device prototypes based on two complementary platforms suitable for follow-on development. In establishing these prototype platforms, our primary goals will be to:

- Demonstrate for the first time the benefits of carbon nanomaterials (CNM) as active light harvesting components.
- Demonstrate that CNM can be used to overcome key performance limitations of solar cells.
- Demonstrate the potential of integrated CNM-based photovoltaic devices.

To meet these goals we will: i) Establish the fundamental photophysical and electrochemical behaviors of CNM chromophores and the means to control and tune the associated energy and charge flows. ii) Establish the principles for CNM materials integration into functioning

photovoltaic devices. iii) Pursue these objectives within the context of the interfacial interactions dictated by two primary device architectures we view as the most promising for realizing all-CNM photovoltaics. These include a layered thin-film platform and a dye-sensitized solar cell configuration, where our CNM become the active dye.

Benefit to National Security Missions

Our effort introduces a promising new approach that will enhance LANL's portfolio in renewable energy research, which must continue to grow and strengthen to meet the critical energy challenges facing the nation. Success will contribute to reducing climate disruption threats while ensuring our nation's future energy security and thus national security. Our approach does not rely on rare, isolated, or politically inaccessible resources. We thus will be pioneering new earth-abundant materials to solve energy problems, while developing/controlling new multifunctional semiconductor and photonics materials. Beyond energy-harvesting applications, advances from our effort will also impact threat reduction needs through detector and sensors development and photonics applications, all of which rely on similar photophysical processes as will be studied here.

Our discovery position in the emerging areas of graphene oxide and defined-composition nanotube bundles as optical nanomaterials also places us at the forefront of such areas as probing their photophysical properties, understanding and controlling energy and charge flow in these systems, and determining how these dynamical processes are defined by the interfacial interactions of multiple materials. With relevant behaviors and interactions arising and playing out across nm to um length scales and dynamical processes occurring from fs to ms timescales, these questions go to the heart of understanding functional behaviors that are defined at the mesoscale. Thus, our studies also address DOE Office of Science needs for improved basic understanding of materials and fundamental chemistry for materials control.

Progress

Materials Development

Isolating highly enriched semiconducting material is critical to our PV device development. We have developed a new approach based on an aqueous two-phase (ATP) separation technique for isolating (6,5) nanotubes in a single step. The process is rapid (5 minutes) and highly scalable (to liters) while providing results for long (microns) tubes. We show the mechanism works on diameter-dependent mixed micelle structures and compositions, rather than through direct interactions between the nanotube surface and separation medium. Most importantly the ATP processing is shown to be compatible with our PV film development. We have also demonstrated the approach as a rapid method for removal of unwanted nanotube bundles. One paper is published and a second in review.

On graphene oxide materials, we have performed the first electrostatic force microscopy measurements evaluating the dependence of charge transport and dynamics in this material as a function of surface functionality. Direct photoluminescence microscopy has also been employed as a complement to FT-IR microscopy to evaluate the dependence of optical properties on surface functionalization. Two papers on these subjects are in preparation.

Thin Film Architectures

Films are generated via a filtration technique. Advances are now allowing control over film morphology and ordering and improved film qualities. We have translated this into successful thin-film devices. The current-voltage characteristics of the devices are fed back into our PV-device development, leading to our first successful PV devices. This advance is a result of reduced metal content, longer tubes, and the improved film morphologies. With our higher quality films we now observe PV-response as good as published results. Film analysis shows we still need to control our uniformity and reproducibility. Photocurrent vs. absorbance curves confirm the nanotubes are serving as active light harvesters in these devices, which are now at a point where they provide useful feedback into our processing methods and are near ready for physics measurements.

DSSC Cells

Nanographene molecules are being studied as light harvesting chromophores. We have successfully completed chemical synthesis of our first versions and are improving their solution solubilities. We show in-situ synthesis as an effective integration approach, where the final step is performed after effectively adsorbing the precursor molecules to TiO₂. This effective strategy has provided a record PV response for these systems. The work is submitted for publication.

As alternative chromophores, chemically cut nanotubes (to 30 nm) have been integrated into the DSSCs. Strong absorbance across a broader range than typical dyes has been observed. Electrochemical measurements on the integrated cells, however, demonstrated relative energies of the cut tubes vs. TiO₂ would lead to poor coupling and charge injection. The behavior suggested the tubes as a hole transport material of interest for our solid state electrolyte effort. Effective solid-state electrolytes are being generated via incorporation of ionic liquids into sol-gels via a microwave driven process. Cut tubes are shown to enhance electrolyte performance, approaching that of common electrolytes but with improved stabilities. A paper is in preparation.

Fundamental Photophysics

Raman is being used as a probe of intertube interactions in defined composition bundles. New delocalized exciton states are shown to arise that may be useful in directing energy flow. Single-tube optical measurements are being developed for probing exciton transport in such bundles. Tests have shown intriguing coupling between exciton-exciton annihilation processes and photon emission statistics. We probe optical response of covalently doped tubes as model trap states. We find dopant sites act to localize excitons, and through pairing with theory, assign specific spectral response to chemical functionality.

Theory

Theoretical modeling has focused on quantum chemical calculations of these model oxygen and aryl-diazonium doped carbon nanotubes. Density Functional Theory simulations were able to elucidate dopant structure and binding energies. Calculations of the excited states allowed to understand the interplay of excitonic states and spatially localized dopant states. The theoretical results reproduce well spectroscopic data and allow attaining deep insights into photoexcited dynamics of chemically functionalized carbon nanotubes.

Capability Development

Our femtosecond pump probe apparatus is now fully functional. We developed and implemented a microscope capable of doing spatially correlated scanning photocurrent, spectral photoluminescence imaging, and time correlated single photon counting. We are calibrating the system using high brightness polymer devices in preparation for lower brightness carbon nanotube devices.

Future Work

In response to our mid-project review, we are scaling-back our efforts on graphene oxide and cut nanotubes. Our thin film device efforts are now guiding device development

and our number one priority is to improve film uniformity and reproducibility. Towards that goal we have received an ultrasonic spray coater that will be installed and implemented. In parallel we are developing films based on polyfluorene wrapped tubes. These allow organic solution processing with improved film uniformity. On generation of such films, we will investigate correlated optical and electronic properties of carbon nanotube transistors and solar cells. These measurements will allow us to understand exciton dissociation, trapping, and mobilities in nanotube devices with a unified picture of transport and optics. Fundamental studies at reduced length-scales will focus on transformation of exciton behaviors in defined composition bundles. Efforts will include finishing Raman studies, new developments showing enhanced electron-phonon coupling to nominally dark states and exciton transport in bundles. We will expand a new collaborative effort with Mike Therien (Duke Univ.) establishing polymer wrapped tubes as a new route for defining device morphologies and introducing new optical functionality. In theory, we will continue modeling of doped carbon nanotubes, focusing on dynamical aspects: exciton and charge transport, localization of the dopant and non-radiative relaxation. These provide a direct link to time-resolved spectroscopic probes and will help to unravel complex photoexcited dynamics in photovoltaic architectures. Furthermore, we will start quantum-chemical modeling of structures, energetics and optical properties of chemically well-defined graphene carbon nano-flakes. Towards the graphene development, efforts will focus on improving solubility of nanographene molecules and further characterization of their photophysics and redox processes, with a focus on behaviors within integrated systems. Additional effort will be placed on integration of our solid electrolyte materials into the DSSC systems.

Conclusion

By project's end we expect to i) establish the fundamental photophysical behaviors of our new optical nanomaterials for use as active light-harvesting materials and how to tune these behaviors, ii) establish the principles for carbon nanomaterials integration into functioning photovoltaic devices, and iii) establish the most promising device architectures for follow-on development. The result will be a promising new approach to photovoltaic energy harvesting that overcomes many current limitations. The effort will also create new understanding of the optical behaviors of our new class of materials to advance other applications while also developing powerful new techniques for nanomaterials characterization.

Publications

Adamska, L., I. Nayyar, H. Chen, A. K. Swan, N. Oldani,

S. Fernandez-Alberti, S. K. Doorn, and S. Tretiak. Self-trapping of excitons, violation of the Condon approximation and efficient fluorescence in conjugated cycloparaphenylenes. To appear in *Nano Letters*.

Arnold, M. S., J. L. Blackburn, J. J. Crochet, S. K. Doorn, J. G. Duque, A. Mohite, and H. Telg. Recent developments in the photophysics of single-walled carbon nanotubes for their use as active and passive material elements in thin film photovoltaics. 2013. *Physical Chemistry Chemical Physics*. 15: 14896.

Crochet, J. J., J. G. Duque, J. H. Werner, B. Lounis, L. Cognet, and S. K. Doorn. Disorder limited exciton transport in colloidal single-wall carbon nanotubes. 2012. *Nano Letters*. 12: 5091.

Duque, J. G., L. Oudjedi, J. J. Crochet, S. Tretiak, B. Lounis, S. K. Doorn, and L. Cognet. Mechanism of electrolyte-induced brightening in single-wall carbon nanotubes. 2013. *Journal of the American Chemical Society*. 135: 3379.

Galande, W. e. i. Gao, Mathkar, A. M. Dattelbaum, T. N. Narayanan, A. D. Mohite, and P. M. Ajayan. *Science and Engineering of Graphene Oxide*. 2014. *PARTICLE & PARTICLE SYSTEMS CHARACTERIZATION*. 31 (6): 619.

Ji, Z., R. Wu, L. Adamska, K. Velizhanin, S. K. Doorn, and M. Sykora. In-situ synthesis of graphene quantum dots on TiO₂. To appear in *ACS Applied Materials and Interfaces*.

Ma, X., J. G. Duque, X. Pang, J. Crochet, A. Piryatinski, S. K. Doorn, and H. Htoon. Influences of exciton diffusion and exciton-exciton annihilation on photon emission statistics of carbon nanotubes. To appear in *Physical Review Letters*.

Ma, X., L. Adamska, H. Yamaguchi, S. E. Yalcin, S. Tretiak, S. K. Doorn, and H. Htoon. Electronic structure and chemical nature of oxygen dopant states in carbon nanotubes. To appear in *ACS Nano*.

Sau, J. D., J. J. Crochet, S. K. Doorn, and M. L. Cohen. Multiparticle exciton ionization in shallow doped carbon nanotubes. 2013. *Physical Chemistry Letters*. 4: 982.

Solenov, D., C. Junkermeier, R. L. Reinecke, and K. A. Velizhanin. Tunable adsorbate-adsorbate interactions on graphene. 2013. *Physical Review Letters*. 111: 115502.

Subbaiyan, N. K., Cambre, A. N. G. Parra-Vasquez, E. H. Haroz, S. K. Doorn, and J. G. Duque. Role of Surfactants and Salt in Aqueous Two-Phase Separation of Carbon Nanotubes toward Simple Chirality Isolation. 2014. *ACS NANO*. 8 (2): 1619.

Subbaiyan, N., A. N. G. Parra-Vasquez, S. Cambre, M. A. Santiago Cordoba, S. E. Yalcin, C. E. Hamilton, N. H. Mack, J. Blackburn, S. K. Doorn, and J. G. Duque. Benchtop extraction of isolated individual single-walled carbon nanotubes. *Nanoscale*.

Velizhanin, K. A., Dandu, and Solenov. Electromigration of bivalent functional groups on graphene. 2014. *PHYSICAL REVIEW B*. 89 (15).

Design Principles for Materials with Magnetic Functionality

Joe D. Thompson
20130052DR

Introduction

Advanced materials have been and will continue to be essential for the country to remain globally competitive and to ensure our energy and defense security. Magnetism underpins many energy-efficient technologies, notably wind turbines and 'green' automobiles, but magnetism is an intrinsically complex and delicate collective-electron function that is reflected in the multiple electronic properties of materials that must be satisfied simultaneously to produce useful function. Magnets presently used in these technologies rely on nationally critical rare and expensive elements, and despite decades of making-and-measuring to find new magnetic materials that are free of those critical elements, this approach has not been successful. Progress requires a strategy based on scientific principles that ultimately will allow the design of suitable replacement magnetic materials. With remarkable recent advances in quantum chemistry and in modeling the consequences of complex electronic properties as well as our ability to test predictions with new experimental techniques, the discovery, understanding and application of principles for control of strong magnetic properties in metals rich in earth-abundant elements is within grasp. In a closed loop of state-of-the-art computation, theoretical modeling, materials synthesis, and in-depth measurements, we will determine and test scientific principles that will allow the designed control of magnetic properties in advanced materials suitable for application in energy-efficient technologies.

Benefit to National Security Missions

The computationally motivated, experimentally validated design of new materials with specified functionality has emerged as a major scientific challenge for materials physics and chemistry, a challenge that must be met to satisfy ever increasing demands for advanced materials that underpin the Nation's energy security and competitiveness. Strongly magnetic materials are key to numerous energy-efficient technologies, but their useful func-

tion presently relies on rare and expensive elements. We will discover scientific principles that will allow designed control of materials that are strongly magnetic and free of critical rare elements. The same techniques for rational materials design may eventually benefit the weapons program.

Progress

Substantial progress has been made through close interaction among team members in a closed loop of computation, theoretical modeling, synthesis and experimental validation. This past year has had three primary thrusts: use of density functional theory to predict new materials with promise for desired magnetic properties, in depth theoretical and experimental study of a prototype material YCo₅, and the development of new and robust schemes for calculating the essential figure-of-merit, the magnetic anisotropy energy (MAE).

From over 150 density functional calculations during this past year, we have predicted magnetic properties of materials in Fe₃GeTe₂, Ti₃Co₅B₂ and Mo₅SiB₂ structure types, synthesized approximately 50 variants of these materials and determined the magnetic properties of many of them. Among those materials, the hexagonal Fe₃GeTe₂ family is most promising, particularly Fe₃GeTe₂ itself. Our magnetic measurements show that its MAE density is 1.5×10^7 erg/cm³, among the highest of rare-earth-free ferromagnets. Though its ferromagnetic ordering temperature is too low (220 K) for practical applications, this temperature can be raised to 255K, without a change in MAE, by replacing 10% of the Te atoms with Bi, as expected from our theoretical predictions. In spite of its ordering temperature, Fe₃GeTe₂ is promising for refining design principles and is being studied in depth using the many techniques available to us.

Much attention has been given to rare-earth-free YCo₅, which has a very high ordering temperature and a MAE

density nearly five times higher than Fe₃GeTe₂. To account for its magnetic properties, we have developed a theoretical framework (Local Density Approximation + Dynamical Mean Field Theory – LDA+DMFT) that includes realistic Coulomb, crystal-field and spin-orbit interactions on all 5 d-orbitals of Co. Such a calculation is the first of its kind. These calculations show that the MAE density is double-valued as a function of the Coulomb energy U, but our photoemission measurements constrain the value of U to be about 5 eV, which from our calculations gives the measured MAE density. This large U implies that electron-electron correlations are important, a fact that we have demonstrated by comparing the measured electronic specific heat with calculations that ignore these correlations. This is a significant new design principle that has not been appreciated previously by anyone. It is important to note that the energy of the critical property, MAE, is more than three orders of magnitude smaller than U and much smaller than any other energy scale in the problem, highlighting the difficulty of accurately predicting the MAE from first principles as we have done so successfully. These calculations further predict that the MAE of YCo₅ might increase by a factor of six if we could tune the value of U to half its intrinsic value and also predict with remarkable accuracy (and with no adjustable parameters) the orbital moment that we have confirmed by x-ray magnetic circular dichroism measurements.

LDA+DMFT is a time-intensive calculation. Consequently, we have focused on developing faster correlated electron techniques for estimating the MAE with the precision that is required for establishing predictive design principles. To this end, we have implemented a much faster variational Gutzwiller (GW) algorithm for adding correlations to band-structure calculations. This method is tailored for capturing the intra-atomic correlations that lead to the full and orbital magnetic moment formation, and consequently the MAE. Our preliminary results indicate that this new method can output the MAE in less than one day versus two weeks using LDA+DMFT. We are in the process of combining the “Gutzwiller solver” with LDA calculations that generate the tight-binding parameters for each specific compound. The development of a GW+LDA algorithm for computing the electronic structure of correlated materials is not only relevant for this project but also for predicting complex properties of actinides and lanthanides. In parallel, we have developed an all-electron, full potential code that adequately addresses numerical precision issues necessary to test the predictions of any density functional for MAE calculations. This also represents a significant advance.

We continue to pursue program development opportuni-

ties, including writing a full proposal for a new Energy Frontier Research Center of which this work was a major part.

Future Work

We will apply our capabilities in electronic structure calculations, many-electron modeling, materials synthesis and detailed experimental measurements to develop a predictive understanding of crystal-chemical conditions that favor strong ferromagnetic properties in new and known rare-earth-free materials that are identified through calculations and simulations. Specifically, we will explore theoretically and experimentally families of materials that form in hexagonal or tetragonal crystal structures and that are rich in magnetic Co and Fe. We will predict their magnetic properties and validate those predictions by combinations of magnetization, magnetic force microscopy, magnetic circular dichroism and photoemission experiments. In parallel, we will develop new and faster computational algorithms that more accurately predict the intrinsic spin-orbit coupling, and hence magnetic anisotropy energy, that must be optimized in materials to have a sufficiently large magnetic figure of merit to be technologically useful. Results of these calculations will be tested experimentally. By iteratively closing compute, make, model and measure loops, we expect to refine the initial set of design principles developed already in this project for predicting strongly ferromagnetic properties of material devoid of rare-earth elements.

Conclusion

Calculations of electronic structure and magnetic anisotropy, coupled with the solution of theoretical models of complex electronic interactions, will be tested experimentally to establish scientific principles that allow the designed control of the crystal structure and chemical make-up of new materials with magnetic properties favorable for strong magnetism in metallic compounds that do not contain nationally critical elements.

Publications

- Ronning, F., and J. L. Sarrao. Material's prediction scores a hit. 2013. *Physics* . 6: 109.
- Ronning, F., and S. Bader. Rare earth replacement magnets. 2014. *Journal of Physics: Condensed Matter* . 26: 060301.
- Zhu, J. X., M. Janoschek, R. Rosenberg, F. Ronning, J. D. Thompson, M. A. Torrez, E. D. Bauer, and C. D. Batista. LDA+DMFT approach to magnetocrystalline anisotropy of strong magnets. 2014. *Physical Review X*. 4: 021027.

Non-Precious Metal Electrocatalysts for Clean Energy

Piotr Zelenay
20130065DR

Introduction

In order to fully realize the clean energy conversion and storage technologies (fuel cells, metal-air batteries, water electrolyzers for hydrogen generation), highly active, durable, and inexpensive non-precious metal electrocatalysts are needed for oxygen reduction reaction (ORR) and oxygen evolution reaction (OER). In this project, we respond to that grand challenge in electrocatalysis by combining experimental and multi-scale modeling approaches for the purpose of (1) elucidating the nature of the ORR and OER active catalytic sites on the surface of non-precious metal catalysts, (2) probing the interplay between meso- and nanoscale controls on electrocatalyst performance, and (3) designing and synthesizing catalysts with the structure optimized for maximum oxygen reduction/evolution activity and required performance stability.

Active-site characterization from density functional theory (DFT) and model system experiments provide insights into ORR & OER reaction mechanisms and the molecular nature of the active site. Mesoscale/multiphysics studies using lattice Boltzmann method (LBM) guide the synthesis towards materials with appropriate physicochemical properties. Ultimately, information generated from the theory and characterization of model systems will be used to fine-tune catalyst precursors for the design and synthesis of ultra-high performance catalysts. Advanced characterization using nitric oxide (NO) probes, iron-specific nuclear resonance vibrational spectroscopy (NRVS), and other methods are combined with theory to further tune catalyst performance. Stabilization and promotion of optimal active sites is investigated by the employment of carbon and non-carbon (i.e. oxide) template structures.

Research in this project aims at advancing the fundamentals of oxygen electrocatalysis and developing novel materials and concepts for energy applications. The proposed effort directly tackles two top research priorities

in the LDRD Energy & Earth Systems Challenge, including the need to utilize earth-abundant elements in place of precious metals. Ultimately, this proposed work will position LANL to target major new initiatives in clean-energy catalysis in the future.

Benefit to National Security Missions

This research directly supports the Los Alamos LDRD Energy & Earth Systems Grand Challenge “concepts and materials for clean energy”. In particular, it tackles the top research priorities of “new materials, for energy applications, containing earth-abundant elements that mimic properties of rare and expensive materials” and “energy generation and efficiency”. This research will enable sustainable and low-cost energy devices with enhanced energy efficiency/capacities, which will position LANL to target new initiatives in meso-scale catalysis, scheduled to be announced by DOE-BES in the near future.

In particular, this research is A-relevant to the DOE-EERE mission of developing alternative energy sources, especially for transportation and stationary applications (fuel cells, hydrogen generation). By being directly relevant to renewable energy this research earns the highest mark in the energy security category. Finally, this effort focuses on the fundamental understanding of materials for two possibly most challenging reactions in electrochemistry, oxygen reduction and evolution, using a combination of modeling, experimentation with model systems, and catalyst development. This makes this project very highly relevant to both basic understanding of materials and fundamental chemistry.

Progress

Model Systems

To achieve the goal of rational synthesis of non-precious metal catalyst (NPMC) systems for oxygen reduction reaction (ORR), we have focused our efforts on the synthesis of model systems based on graphene (G) and

graphene oxide (GO). In the past year, we have studied GO-based catalysts for oxygen reduction. We have revealed for the first time that water plays a key role in the formation of catalytic active site and needs to be accounted for in the catalyst design. We have investigated how effective removal of water from the sheets of graphene oxide, using various solvents and vacuum treatments, results in highly ordered GO, impacting ORR activity in acid electrolytes. Obtained materials have not only been the best performing GO-based ORR catalysts but also offered high durability (less than 30 mV drop in oxygen-saturated solution and less than 15 mV drop in nitrogen-saturated solution over 2000 potential cycles). We have also identified that graphitic-carbon-supported catalysts have low peroxide yield compared to catalysts based on amorphous carbon supports, and that pyridinic nitrogen content is important for achieving high electrochemical activity. We have observed the presence of trace impurities of metals including Mn and Fe and have investigated their important role in ORR catalysis.

In an effort to avoid transition metal presence, we have been able to successfully incorporate nitrogen atoms into a graphene lattice using the ENABLE source. This is unique amongst nitrogen doping approaches as it produces relatively mono-dispersed nitrogen defects and preserves the overall graphitic nature of the carbon substrate. These materials have been prepared on TEM grids as well as carbon microelectrodes for electrochemical characterization as well as detailed electron microscopy using ORNL's UltraSTEM. We anticipate their full characterization by the end of the fiscal year.

Theory

We have continued to use static and dynamic density functional theory (DFT) calculations to investigate the properties of the active site(s) in model systems and a new lattice Boltzmann model (LBM) for pore-scale investigation of multicomponent multiphase reactive transport, capable of handling large density ratios between liquid and gas phases.

Our quantum mechanical modeling efforts have predicted a novel iron-nitrogen complex at graphene edges that has the highest oxygen reduction reaction (ORR) activity reported to date for NPMCs. This structure has been discovered based on its high stability and such structures are likely to improve fuel cell cathode durability as well as activity. Additionally, a three-dimensional lattice Boltzmann model that includes hydrogen and water transport has been developed to study how electrode structure affects mass transport. The quantum mechanical calculations are being tied into this model, allowing fundamental questions regarding how non-precious metal catalysts function in

fuel cells to be addressed.

In close connection to the LBM effort, we have completed neutron imaging of non-precious metal catalysts to determine water content in the various membrane electrode assembly components. The results of this study provide input parameters for lattice Boltzmann modeling.

Catalyst Synthesis

GO and reduced graphene oxide (rGO) have been systematically explored in the synthesis of non-precious metal ORR catalysts. Compared to NPMC catalysts supported on traditional nanoparticle carbons, such as Ketjenblack, the GO-derived catalysts exhibit enhanced durability in acid media. Additionally, much improved ORR activity has been achieved with GO-derived catalysts in alkaline media, possibly due to the unique morphology of GO with increased exposition of edge sites.

The role of manganese (Mn) in inducing ORR activity of NPMCs has been studied as a function of nitrogen/carbon precursors, heat-treatment temperature, and the total metal amount implemented in the synthesis. It has been concluded that GO-based catalysts, obtained by various research groups worldwide using Hummers synthesis method, likely impart their ORR activity as a result of Mn contamination at the graphene oxidation step, in which potassium permanganate is used as oxidant.

Finally, $(\text{La}_{1-x}\text{Sr}_x)\text{CoO}_{3-\delta}$ has been selected and studied as a non-precious metal catalyst for oxygen evolution reaction (OER), as a part of the development of bifunctional ORR/OER catalyst. In a preliminary study, $(\text{La}_{1-x}\text{Sr}_x)\text{CoO}_{3-\delta}$ has shown activity similar to the state-of-the-art OER catalysts reported in the scientific literature. Metal-nitrogen-carbon (M-N-C) catalysts will be adopted as ORR-active component of the bifunctional catalyst, with the focus being on improvements to the corrosion resistance through enhancements to the catalyst graphitic content.

Future Work

Model Systems

Next year, we will concentrate next on the nature of active site in non-precious oxygen reduction reaction (ORR) catalysts. Key next-year goals are as follows:

- Eliminate trace metal impurities in model graphene/graphene oxide systems; further improve catalyst order.
- Develop model catalysts based on no more than few layers of graphene sheets obtained via the surfactant exfoliation of graphite or chemical vapor deposition.
- Use energetic neutral atom beam lithography/epitaxy

(ENABLE) at various conditions (kinetic energy, temperature, and exposure time) as a method of well-controlled nitrogen doping.

- Obtain correlated electrochemical and microscopy measurements to identify the active site and obtain model catalysts.
- Apply various solvent treatments to enhance the activity of catalysts.
- Develop design principles for guided synthesis of high-performance non-precious active catalyst systems.
- Use various neutron techniques available at Lujan Center to determine fundamental properties of graphene and graphene oxide-based materials (e.g., proton conduction, interaction with water).

Theory

Future work in theory will focus on further investigation of metal-nitrogen-carbon structures that may be ORR active and integration of models and experimental observations to produce a predictive multi-scale model for non-precious metal based fuel cell cathode performance.

In connection with the theory effort, we will quantify mass transport losses in non-previous metal-based membrane electrode assemblies and provide both model validation and input parameter data to the lattice Boltzmann modeling.

Catalyst Synthesis

In the catalyst synthesis part of the project we will:

- Study interactions between nitrogen, transition metal, and carbon during the formation of active ORR site in practical catalysts.
- Start implementing knowledge gained from model systems in practical catalyst development (e.g., role of water).
- Synthesize first bifunctional ORR/OER (OER = oxygen evolution reaction) catalyst in a hybrid configuration (e.g., core-shell structure).

Conclusion

The primary outcome of this project is a fundamental understanding of non-precious metal ORR and OER catalysis in electrochemical energy systems. It includes reaction mechanisms, active-site structures, and synthesis-structure-reactivity correlations. In particular, integration of modeling of the active site with mesoscale theory allows for coupling of intrinsic site reactivity with mesostructure-

sensitive kinetics, providing “real-world” activity directly comparable to the experimental measurements. First-principles calculations assist in interpreting spectroscopic and electrochemical signatures emerging from characterization studies. The fundamental understanding of electrocatalysis will be used to design, synthesize, and demonstrate next-generation non-precious metal catalysts with high performance and durability.

Publications

Chen, L., G. Wu, E. F. Holby, P. Zelenay, W. Tao, and Q. Kang. Lattice Boltzmann investigation of reactive transport in Pt and non-precious metal cathode catalyst layers of proton exchange membrane fuel cells. To appear in *Journal of Power Sources*.

Chen, L., Q. Kang, Q. Tang, B. A. Robinson, Y. He, and W. Tao. Pore-scale simulation of multicomponent multiphase reactive transport with dissolution and precipitation. To appear in *International Journal of Heat and Mass Transfer*.

Chen, L., Q. Kang, Y. L. He, and W. Tao. A critical review of the pseudopotential multiphase lattice Boltzmann model: methods and applications. 2014. *International Journal of Heat and Mass Transfer*. 76: 210.

Chen, L., Y. L. He, Q. Kang, and W. Tao. Coupled numerical approach combining finite volume and lattice Boltzmann methods for multi-scale multiphysics processes. 2013. *Journal of Computational Physics*. 255: 83.

Chung, H. T., G. Wu, Q. Li, and P. Zelenay. Role of two carbon phases in oxygen reduction reaction on the Co-PPy-C catalyst. 2014. *International Journal of Hydrogen Energy*. 39: 15887.

Chung, H. T., J. H. Won, and P. Zelenay. Active and stable carbon nanotube/nanoparticle composite electrocatalyst for oxygen reduction. 2013. *NATURE COMMUNICATIONS*. 4: -.

Elbaz, L., G. Wu, and P. Zelenay. Heat-treated non-precious-metal-based catalysts for oxygen reduction. 2013. In *Electrocatalysis in fuel cells: A non- and low-platinum approach*. Edited by Shao, M., p. 231. London: Springer-Verlag.

Gao, W., G. Wu, M. T. Janicke, D. A. Cullen, R. Mukundan, J. K. Baldwin, E. L. Brosha, C. Galande, P. M. Ajayan, K. L. More, A. M. Dattelbaum, and P. Zelenay. Ozonated graphene oxide film as a proton exchange membrane. 2014. *Angewandte Chemie International Edition*. 53: 3588.

Higgins, D., G. Wu, H. T. Chung, U. Martinez, S. Ma, Z. Chen, and P. Zelenay. Manganese-based non-precious metal

-
- catalysts for oxygen reduction in acidic media. 2014. ECS Transactions. 61 (31): 35.
- Holby, E. F., G. Wu, P. Zelenay, and C. D. Taylor. Modeling non-precious metal catalyst structures and their relationship to ORR activity. 2013. ECS Transactions. 58 (1): 1859.
- Holby, E. T., G. Wu, P. Zelenay, and C. D. Taylor. Structure of Fe-Nx-C defects in oxygen reduction reaction catalysts from first principles modeling. 2014. Journal of Physical Chemistry C. 118: 14388.
- Hussey, D. S., D. L. Jacobson, D. Liu, B. Khaykovich, M. V. Gubarev, D. Spornjak, G. Wu, J. Fairweather, R. Mukundan, R. Lujan, P. Zelenay, and R. L. Borup. Neutron imaging of water transport in polymer-electrolyte membranes and membrane-electrode assemblies. 2013. ECS Transactions. 58 (1): 293.
- Liu, H., Q. Kang, C. R. Leonardi, B. D. Jones, S. Schmieschek, A. Narvaez, J. R. Williams, A. J. Valocchi, and J. Harting. Multiphase lattice Boltzmann simulations for porous media applications - a review. To appear in Computational Geosciences.
- Martinez, U., T. L. Williamson, K. Artyushkova, N. H. Mack, G. M. Purdy, J. H. Dumont, D. Kelly, W. Gao, A. M. Dattelbaum, A. Mohite, G. Gupta, and P. Zelenay. Thin-film non-precious metal model catalysts for oxygen reduction reaction. 2014. ECS Transactions. 64 (3): 293.
- Wu, G., and P. Zelenay. Nanostructured Nonprecious Metal Catalysts for Oxygen Reduction Reaction. 2013. ACCOUNTS OF CHEMICAL RESEARCH. 46 (8): 1878.
- Yalcin, S. E., C. Galande, R. Kappera, H. Yamaguchi, K. A. Velizhanin, S. K. Doorn, A. M. Dattelbaum, M. Chhowalla, P. M. Ajayan, G. Gupta, and A. D. Mohite. Imaging charge transport pathways in progressively reduced graphene oxide using electrostatic force microscopy. AC Nano.
- Yamaguchi, H., J. Granstrom, W. Nie, H. Sojoudi, T. Fujita, D. Voiry, M. Chen, G. Gupta, A. D. Mohite, S. Graham, and M. Chhowalla. Reduced graphene oxide thin films as ultrabarriers for organic electronics. 2013. Advanced Energy Materials. : DOI: 10.1002/aenm.201300986.

Phase Stability of Multi-Component Nanocomposites under Irradiation

Blas P. Uberuaga

20130118DR

Introduction

We propose to design multi-component nano-composite materials that resist radiation-induced solute redistribution (RISR) and thus maintain stable nano-phases at extremes of high dose irradiation at elevated temperatures. The next generation of nuclear energy systems will not be possible without the development of such new materials. Further, the accident at the nuclear plant at Fukushima demonstrates the need for advanced clad materials that not only can sustain high burn-up but are also resistant to other phenomena such as corrosion.

The design of materials that are essentially “immune to radiation”, as called for by DOE, is one of the grand challenges in the materials science discipline. This is because energetic radiation damages a material by a variety of very different mechanisms, such as void swelling, embrittlement, irradiation creep, and phase instabilities from radiation induced solute redistribution (RISR). Typically, the solution for one problem either has no effect on or exacerbates the other damage mechanisms. For example, using interfaces as sinks for vacancies and interstitials can reduce void swelling but the same interfaces that mitigate void swelling can increase RISR.

RISR causes phase instabilities that lead to catastrophic failure through embrittlement, fracture and corrosion. We propose an innovative solution to the chronic problem of radiation-induced phase instability: nano-composite materials design via interfaces that minimize defect fluxes, which is the origin of RISR. We hypothesize several factors we can use to control defect fluxes and suppress RISR. We propose a materials co-design R&D approach where experiments and multi-scale modeling are closely integrated to test our hypotheses, develop a fundamental understanding of RISR to interfaces, and advance design principles for next-generation materials for nuclear energy applications that maintain chemical composition profiles that are critical for many materials properties in extreme environments.

Benefit to National Security Missions

Our aim is to develop a basic understanding of a primary damage failure mode in materials under irradiation: radiation-induced solute redistribution. This leads to phase separation, dissolution of important secondary phases, and changes in chemical composition that accelerate materials failure in nuclear energy systems. By developing a basic understanding of these materials, we will formulate design principles that will allow us to propose future nuclear energy materials that resist such damage and failure.

That this is a fundamental materials approach, this is clearly relevant to the DOE Office of Science, particularly Basic Energy Sciences (BES). If successful, the types of materials we would propose would also be of interest to Fusion Energy Sciences (FES) within the Office of Science, as well as the Office of Nuclear Energy, which is more focused on fission energy systems.

This work would enhance energy security by enabling future generation nuclear energy systems that are more robust and thus more politically and socially acceptable as replacements for fossil energy sources. Further, by developing more radiation tolerant claddings, nuclear fuel could be burned to greater amounts, reducing the quantity of spent fuel in storage and the consequent load on any future nuclear waste repository.

Fuel cycle research of this sort builds capability for nuclear nonproliferation in general.

Progress

This project has made significant progress towards its scientific goals. We highlight three of those here.

First, using kinetic Monte Carlo (KMC) simulations, we have validated that one of the hypotheses of the proposal, that radiation induced solute redistribution (RISR) can be controlled via interfacial spacing. The KMC simu-

lations clearly show that RISR is reduced as the interfacial spacing is reduced. Thus, RISR should be less pronounced in materials with nanosized microstructures as opposed to larger grained material. We are currently preparing samples with varying interfacial spacing to validate this prediction. We are also developing a phase field model that can further examine the ramifications of this prediction for more complicated microstructures than possible with the KMC. However, this result suggests a clear path forward for developing materials with enhanced resistance to solute redistribution under irradiation. The KMC results are being prepared for publication.

Secondly, we have experimentally interrogated another hypothesis of our proposal, that RISR depends on the types of interfaces present in the material. We have tested this by synthesizing a series of multilayer composites, each containing Fe+Cr layers which are sandwiched between different oxides. The oxides include Y₂O₃, TiO₂, and MgO. These systems are meant to mimic the nanoferritic alloys that have been proposed for advanced nuclear applications. We have found that the segregation of Cr to the interface depends on the nature of the interface. In the case of MgO, we find that Cr content is indeed enhanced at the interface. In the case of TiO₂, Cr diffuses all the way through the layer. We have determined that this is a consequence of non-stoichiometry (oxygen deficiency) in the TiO₂ layer, which eases the incorporation of Cr into the TiO₂ layer, ultimately leading to the enhanced amorphization of the TiO₂ layer. In the case of Y₂O₃, Cr penetrates the Y₂O₃ layer, but only near the interface. Thus, the behavior of Cr is very sensitive to the nature of the oxide present. These results have been complimented by density functional theory (DFT) calculations of the interaction of solutes in these oxides. In particular, DFT shows that solute segregation to such interfaces is very sensitive to the local oxygen content, with excess oxygen tending to favor the segregation of Cr but repelling Ni. Further DFT calculations support the conclusion that the non-stoichiometry of TiO₂ is a principle factor in the incorporation of Cr, which explains the phase stability of this system. Finally, nuclear resonance experiments have been performed that provides further information on the structure of these interfaces, showing that they are often not atomically sharp but can be diffuse depending on the growth conditions.

Thirdly, we have examined the Ni-Al system, which is a model system for Inconel, which is used as a window material, for example, at the Isotope Production Facility. The experiments show that the stability of composites of Ni/Ni₃Al are very sensitive to the composition of the composite, with significant redistribution of Al if the composition is far from equilibrium. Experiments on a model engineering

material that is based on Ni-Al (Rene N4) show that (a) the ordered phases disappear quickly upon irradiation and (b) the distribution of minor alloying elements spreads upon irradiation. This is being supported by atomistic modeling to understand how the stability of the ordered phases depends on doping, with the goal of identifying dopants that can enhance the stability of these materials.

For all of these efforts, we are currently writing manuscripts that summarize these results that we will be submitting throughout the summer. We expect a significant scientific output from these studies. We have also been presenting these results at various international conferences, including the TMS and CAARI meetings.

Finally, we had our mid-project Appraisal, with committee members Quanxi Jia, Chris Stanek, Alan Ardell, and Dane Morgan, in February 2014. We received rankings of Excellent or Outstanding in each category. The committee did have a few suggestions which we have considered and incorporated into our effort.

Future Work

During the next (and last) fiscal year of the project, we will focus on two tasks.

First, on the modeling side, we will develop our phase field model to the point that we can make qualitative predictions of the role of microstructure, irradiation conditions (particularly damage generation rate and temperature), and the nature of the alloying elements in the material on the segregation of species within the material. The facets of microstructure we will focus on include the nature and distribution of interfaces. These phase field simulations will be complemented by kinetic Monte Carlo simulations that provide more detailed descriptions but are computationally more costly. The phase field simulations will provide the overall design space in which the microstructure can be tuned to reduce or eliminate radiation induced segregation.

These modeling efforts will be supported by two experimental efforts. In the first, we will synthesize multilayer Fe/oxide systems, varying the layer thickness. (Our previous work focused on the role of the interface structure, varying the type of oxide used; here we will pick one oxide and vary the length scale.) This will provide us with direct experimental evidence that changing the microstructural length scales can influence radiation induced segregation, something that we have predicted from our modeling efforts. The Fe layers will be doped with various elements to show how different elements can interact to further suppress the segregation. The second set of experiments will examine segregation in Ni/Ni-Al systems, comparing

model multilayer systems with radiation damage experiments in real engineering materials such as Rene N4. This will provide the confidence needed to state that the model systems exhibit similar physical behavior as the more complicated engineering materials.

Yuryev, D. V., and M. J. Demkowicz. Computational design of solid-state interfaces using O-lattice theory. *Applied Physics Letters*.

Conclusion

The goal of this project is to understand and control the atomic scale processes that lead to redistribution of elements in complex alloys during irradiation. The key results of this project will be (i) development of a multi-length and multi-time scale model to predict solute/elemental redistribution in a given alloy as a function of interface properties and spacing, (ii) tests of the hypotheses correlating the interface properties to RISR in nanocomposites, and (iii) development of figures-of-merit from the integrated results of all the hypotheses.

Publications

Aguiar, J. A., O. Anderoglu, S. Choudhury, J. K. Baldwin, Y. Q. Wang, A. Misra, and B. P. Uberuaga. Nanoscale morphologies at alloyed and irradiated metal/oxide bilayers. *Journal of Materials Science*.

Choudhury, S., J. A. Aguiar, M. J. Fluss, L. L. Hsiung, A. Misra, and B. P. Uberuaga. Non-uniform solute segregation at semi-coherent metal/oxide interfaces. *Scientific Reports*.

Lee, T., A. Caro, and M. J. Demkowicz. Atomistic modeling of radiation-induced disordering and dissolution at a Ni/Ni₃Al interface. *Journal of Materials Research*.

Martinez, , B. P. Uberuaga, and A. F. Voter. Sublattice parallel replica dynamics. 2014. *PHYSICAL REVIEW E*. 89 (6).

Martinez, E., and B. P. Uberuaga. Mobility and coalescence of small stacking fault tetrahedra in Cu. *Nature Communications*.

Senninger, , Martinez, Soisson, Nastar, and Brechet. Atomistic simulations of the decomposition kinetics in Fe-Cr alloys: Influence of magnetism. 2014. *ACTA MATERIALIA*. 73: 97.

Watkins, E. B., Kashinath, Wang, J. K. Baldwin, Majewski, and M. J. Demkowicz. Characterization of a Fe/Y₂O₃ metal/oxide interface using neutron and x-ray scattering. 2014. *APPLIED PHYSICS LETTERS*. 105 (4).

Xu, Y., S. K. Yadav, J. A. Aguiar, O. Anderoglu, J. K. Baldwin, Y. Q. Wang, J. A. Valdez, A. Misra, H. M. Luo, B. P. Uberuaga, and N. Li. Solute redistribution and phase stability at FeCr/TiO_{2-x} interfaces under ion irradiation. *Acta Materialia*.

Quantum Chemistry, Information, Materials and Metrology

Robert E. Ecke
20130727DR

Introduction

The goals of this project are to develop collaborative scientific progress at the interfaces of quantum chemistry and materials, quantum information and communication, and quantum optics. In particular, we will explore the intersection of quantum information, communication and computing with new materials functionality such as chiral superconductors and topological insulators and also with novel detection technology such as ultra-sensitive scanned probes. We will develop new computational approaches based on algorithms developed in quantum information science to more efficiently solve numerically quantum condensed matter models. We will explore the fascinating overlap between cold atom physics, with its pure systems and tunable properties, and technologically important materials systems such as superconductors and multiferroic materials. In this latter category, the interplay between electrons and the underlying field leads to exotic states of matter that can provide novel properties or functionalities such as magnetic control of transport properties (anomalous Hall effect), strong vortex pinning (high critical currents) in superconductors, and large magneto-electric effects in insulators. Through our theory and simulations we will identify classes of models and materials where this new functionality can be realized. We will use hybrid quantum chemistry and molecular mechanical methods to incorporate solvent and thermal fluctuation properties of real molecular systems and apply this new phenomenology to carbon nanotubes and biological light harvesting systems. We will investigate fluctuation induced quantum Casimir forces, and corresponding classical analogs, for equilibrium and nonequilibrium conditions. Our external collaborations will enable the use of opto-mechanical resonators for quantum communication, for fundamental studies of quantum friction, and for atomically-resolved spectroscopic scanned probe measurements of condensed matter systems such as quantum phase transitions occurring in novel systems of competing magnetic and superconducting order.

Benefit to National Security Missions

Novel applications of quantum science underpin numerous Laboratory efforts including quantum information that can enable secure data communication, new approaches to quantum devices such as a topological quantum memory, and improved algorithms for simulating scientific problems. Secure data communication has implications for classified environments and for the physical security of infrastructure systems such as the electrical power grid. Novel concepts in manipulating quantum systems will have impact on Laboratory materials strategy including understanding the properties of actinides, in particular plutonium. Possible new quantum sensors could impact GS programs. We strongly impact DOE Office of Science mission in the fundamental understanding of electronic and magnetic materials with applications in energy, electronics, and computing. The ability to support both a robust fundamental science capability and nurture new applications will continue to drive our work in the quantum arena.

Progress

We have made good progress in quantum chemistry and condensed matter physics that we highlight here. In a paper published in Nano Letters we presented a quantum-chemistry formulation of Raman spectroscopy (measures vibrational degrees of freedom) in current-carrying molecular junctions based on a many-body theory of the molecule. The approach goes beyond previous formalisms and provides a convenient way to incorporate computational methods and tools proven for equilibrium molecular spectroscopy into the realm of current carrying junctions. The calculated shift in Stokes lines for a three-ring molecule allows an estimate of vibrational heating by electric current and agrees with available experimental data. This work is a step toward atomistic quantum ab initio modeling of the optical response of non-equilibrium electronic dynamics in molecular junctions.

In condensed matter theory, we have made significant progress, often in collaboration with or motivated by experimentalists. In a paper published in *Physical Review Letters*, we explored a novel material, vanadium spinels, in pulsed magnetic fields up to 65 T. A jump in magnetization at a critical magnetic field strength is observed in the single-crystal material indicating a field induced quantum phase transition between two distinct magnetic orders. In the multiferroic (magnetic and electric response) material, the field-induced transition is accompanied by a suppression of the electric polarization. By modeling the magnetic properties, we show that both features of the field-induced transition can be successfully explained by including the effects of the local crystal field. In a purely theoretical paper in *Physical Review X*, we consider magnetic vortex crystals that arise from quantum fluctuations in highly frustrated quantum magnets. In particular, we provide a simple and robust scenario for inducing magnetic vortex crystals in frustrated Mott insulators. We elucidate a rich quantum phase diagram that includes magnetic vortex crystals. Because skyrmion and domainwall crystals have already been predicted and experimentally observed, this novel vortex phase completes the picture of emergent crystals of topologically nontrivial spin configurations. This work was enabled in part by a new algorithmic approach (published in *Physical Review B*) that allows efficient computation of quantum degrees of freedom coupled to classical (e.g., magnetic) fields. In particular, our approach is orders of magnitude faster than previous methods when applied to very large systems with high accuracy requirements. To demonstrate the method, we studied complex non-coplanar chiral spin textures and explored non-equilibrium mesoscale physics such as chiral domain coarsening and vortex annihilation. Finally, in work published in *New Journal of Physics*, we develop a theory of higher order cumulants of spin noise that yields dynamical information about electrons and atomic gases. We apply our theoretical framework to predict the results of single quantum dot experiments.

Future Work

We will perform research at the interdisciplinary intersections of the fields of quantum science with an emphasis on Quantum Chemistry, Quantum Information and Communication, Atomic-Molecular-Optical (AMO) and Quantum Optics, and Quantum Materials. We will develop synergies among the topics.

Chemistry

- Improve quantum chemical numerical approaches to incorporate non-adiabatic processes, solvent and thermal effects, and many atom simulations to better model complex quantum chemical processes

- Model ultrafast relaxation processes in carbon nano-tubes which have important applications in electronics and optical materials
- Determine the role of long-lived electronic coherence in photosynthetic proteins that exhibit light-harvesting properties

Information and Communication

- Explore the intersection of quantum information algorithms and condensed matter systems to better compute the properties of magnetic spin systems.

AMO and Quantum Optics

- Develop theory and simulations for fluctuation-induced interactions in nanostructures, including Casimir forces, near-field heat transfer, patch effects, and quantum friction
- Explore the use of structuring for novel optical and acoustical phenomena in metamaterials, including sub-wavelength imaging, perfect absorbers
- Use cold atom methods as an ultra-sensitive magnetic field sensors

Materials

- Exploit new efficient algorithms for treating quantum spins in classical fields to explore novel phases of fermionic matter that could lead to new functional materials
- Investigate, using theory, simulation, and experiment, the properties of strongly correlated electron systems with novel magnetic, multi-ferroic and superconducting properties

Conclusion

Quantum science is an integrating centerpiece of numerous LANL strategic directions including information science, sensing, and materials. By supporting an interdisciplinary approach that ranges from fundamental science to applications, our work develops research collaborations among different quantum science areas, sustains and encourages broad scientific capability, and assists in identifying novel and transformational science frontiers at the interface of national security and discovery science.

Publications

Adamska, L., I. Nayyar, H. Chen, A. K. Swan, N. Oldani, S. Fernandez-Alberti, M. R. Golder, R. Jasti, S. K. Doorn, and S. Tretiak. Self-trapping of excitons, violation of Condon approximation and efficient fluorescence in conjugated cycloparaphenylenes. *Nanotechnology Letters*.

- Baillie, D., R. N. Bisset, C. Ticknor, and P. B. Blakie. Anisotropic number fluctuations of a dipolar Bose-Einstein condensate. 2014. arXiv.
- Baratz, A., A. White, and M. Galperin. Effects of electromagnetic coupling on conductance switching of a gated tunnel junction. 2014. *Journal of Physical Chemistry Letters*. : 3545.
- Barros, K., J. W. F. Venderbos, G. W. Chern, and C. D. Batista. Novel magnetic orderings in the kagome Kondo-lattice model. 2014. arXiv.
- Barros, K., and Y. Kato. Efficient langevin simulation of coupled classical fields and fermions. 2013. *Physical Review B*. 88: 235101.
- Behunin, R. O., D. A. R. Dalvit, R. Decca, and C. C. Speake. Limits on the accuracy of isoelectronic gravity measurements at short separation due to patch effects. 2014. *Physical Review D*. 89: 051301.
- Bisset, R. N., C. Ticknor, and P. B. Blakie. Finite-resolution fluctuation measurements of a trapped Bose-Einstein condensate. 2013. *Physical Review A*. 88 (6): 063624.
- Bjorggaard, J. A., V. Kuzmenko, K. A. Velizhanin, and S. Tretiak. Implicit solvent models for first order response calculations. *Journal of Chemical Physics*.
- Bjorggaard, J. A., and M. E. Kose. Simulations of Singlet Exciton Diffusion in Organic Semiconductors: A Review. *RSC Advances*.
- Campo, A. Del, and W. H. Zurek. Universality of phase transition dynamics: Topological defects from symmetry breaking. 2014. *International Journal of Modern Physics A*. 29 (08): 1430018.
- Campo, A. del. Shortcuts to Adiabaticity by Counterdiabatic Driving. 2013. *Physical Review Letters*. 111 (10): 100502.
- Campo, A. del, I. L. Egusquiza, M. B. Plenio, and S. F. Huelga. Quantum Speed Limits in Open System Dynamics. 2013. *Physical Review Letters*. 110 (5): 050403.
- Campo, A. del, J. Goold, and M. Pasternostro. More bang for your buck: Towards super-adiabatic quantum engines. 2013. *Scientific Reports*. 4: 6208.
- Campo, A. del., T. W. Kibble, and W. H. Zurek. Causality and non-equilibrium second-order phase transitions in inhomogeneous systems. 2013. *Journal of Physics: Condensed Matter*. 25 (40): 325701.
- Chen, H., Y. Y. Tai, C. S. Ting, M. J. Graf, J. Dai, and J. X. Zhu. Disorder effects in multiorbital s_{\pm} -wave superconductors: Implications for Zn-doped BaFe₂As₂ compounds. 2013. *Physical Review B*. 88 (18): 184509.
- Chern, G. W., C. C. Chien, and M. Di Ventra. Dynamically generated flat-band phases in optical kagome lattices. 2014. *Physical Review A*. 90 (1): 013609.
- Chern, G., A. Rahmani, I. Martin, and C. Batista. Quantum Hall ice. 2012. Arxiv.
- D'Alessio, L., and A. Rahmani. Thermally isolated Luttinger liquids with noisy Hamiltonians. 2013. *Physical Review B*. 87 (17): 174301.
- Das, T., and A. Rahmani. A renormalization-group study of the symmetry-breaking order parameters in spin-orbit coupled iridates and related systems. 2013. arXiv.
- Delgado, F., C. D. Batista, and J. Fernando-Rosa. Local probe of fractional edge states of S=1 Heisenberg spin chains. 2013. *Physical Review Letters*. 111 (16): 167201.
- Glazenapp, P., N. A. Sinitsyn, L. Yang, D. G. Rickel, D. Roy, A. Grelich, M. Bayer, and S. A. Crooker. Spin noise spectroscopy beyond thermal equilibrium and linear response. 2014. *Physical Review Letters*. 113 (15): 156601.
- Impens, F., R. Behunin, C. C. Ttira, and P. Maia. Neto. Non-local double-path Casimir phase in atom interferometers. 2013. *EPL (Europhysics Letters)*. 101 (6): 60006.
- Intravaia, F., R. O. Behunin, and D. A. Dalvit. Quantum friction and non-equilibrium fluctuation theorems. 2013. Arxiv.
- Kamiya, Y., and C. Batista. Magnetic vortex crystals in frustrated Mott insulator. 2014. *Physical Review X*. 4: 011023.
- Kato, Y.. Multidiscontinuity algorithm for world-line Monte Carlo simulations. 2013. *Physical Review E*. 87 (1): 013310.
- Kim, J. W., Y. Kamiya, E. D. Mun, M. Jaime, N. Harrison, H. Yi, Y. S. Oh, S. W. Cheong, C. D. Batista, and V. S. Zapf. Coexistence of Ising and Heisenberg moments in multiferroic Ca₃Co₂-xMn_xO₆. 2014. *Physical Review B*. 89: 060404.
- Kim, J. W., Y. Kamiya, E. D. Mun, M. Jaime, N. Harrison, J. D. Thompson, H. T. Yi, Y. S. Oh, S. -W. Cheong, C. D. Batista, and V. S. Zapf. Multiferroicity with coexisting isotropic and anisotropic spins in Ca₃{2-x}Mn_xSO₆. 2013. Arxiv.
- Knolle, J., G. W. Chern, D. I. Kovrizhin, R. Moessner, and N. B. Perkins. Raman scattering signatures of Kitaev spin liquids in A₂IrO₃ iridates. 2014. arXiv.

- Koutroulakis, G., T. Zhou, C. D. Batista, Y. Kamiya, J. D. Thompson, S. E. Brown, and H. D. Zhou. Magnetic Phases of the Spin-1/2 Triangular-Lattice Antiferromagnet Ba₃CoSb₂O₉. 2013. Arxiv .
- Li, F., A. Saxena, D. Smith, and N. Sinitsyn. Higher-order spin noise statistics. 2013. *New Journal of Physics*. 15 (11): 113038.
- Li, H., M. Catanzaro, S. Tretiak, and V. Chernyak. Excited-State Structure Modifications Due to Molecular Substituents and Exciton Scattering in Conjugated Molecules. 2014. *Journal of Physical Chemistry Letters*. 5 (4): 641.
- Li, H., S. Malinin, S. Tretiak, and V. Chernyak. Effective tight-binding models for excitons in branched conjugated molecules. 2013. *The Journal of Chemical Physics*. 139 (6): 064109.
- Lin, S. Z., X. Wang, Y. Kamiya, and G. W. Chern. Topological defects as relics of emergent continuous symmetry and Higgs condensation of disorder in ferroelectrics. *Nature Physics*.
- Lin, S., Y. Kamiya, G. W. Chern, and C. D. Batista. Stiffness from disorder in triangular-lattice Ising thin films. 2014. *Physical Review Letters*. 112 (15): 155702.
- Lin, S., and D. Roy. Role of kinetic inductance in transport properties of shunted superconducting nanowires. 2013. *Journal of Physics: Condensed Matter*. 25 (32): 325701.
- Mun, E. D., G. W. Chern, V. Pardo, F. Rivadulla, R. Sinclair, V. S. Zapf, and C. D. Batista. Magnetic field induced transition in vanadium spinels. 2014. *Physical Review Letters*. 112 (1): 017207.
- Muniz, R., Y. Kato, and C. Batista. Generalized spin-wave theory: application to the bilinear-biquadratic model. 2013. Arxiv.
- Nei, W., H. Tsai, R. Asadpour, J. C. Blancon, A. J. Neukirch, G. Gupta, J. Crochet, M. Chhowalla, S. Tretiak, M. Alam, H. L. Wang, and A. Mohite. High efficiency solution-processed Perovskite solar cells with millimeter-scale grains. *Science*.
- Nelson, T., S. Fernandez-Alberti, A. E. Roitberg, and S. Tretiak. Artifacts due to trivial unavoided crossings in the modeling of photoinduced energy transfer dynamics in extended conjugated molecules. 2013. *Chemical Physics Letters*. 590: 208.
- Pershin, Y., V. Slipko, D. Roy, and N. Sinitsyn. Two-beam spin noise spectroscopy. 2013. *Applied Physics Letters*. 102 (20): 202405.
- Pyka, K., J. Keller, H. L. Partner, R. Nigmatullin, T. Burgermeister, D. M. Meier, K. Kuhlmann, A. Retzker, M. B. Plenio, W. H. Zurek, A. del Campo, and T. E. Mehlstäubler. Topological defect formation and spontaneous symmetry breaking in ion Coulomb crystals. 2013. *Nature Communications*. 4: 3291.
- Rahmani, A.. Dynamics of noisy quantum systems: application to the stability of fractional charge. 2014. arXiv.
- Rahmani, A.. Quantum dynamics with an ensemble of hamiltonians. 2013. *Modern Physical Letters B*. 27 (26): 1330019.
- Rahmani, A., A. Feiguin, and C. D. Batista. Anyonic liquids in nearly saturated spin chains. 2014. tau.ac.il.
- Rahmani, A., R. Muniz, and I. Martin. Anyons in Integer Quantum Hall Magnets. 2013. *Physical Review X*. 3 (3): 031008.
- Rahmani, A., R. Muniz, and I. Martin. Low-energy theory of a two-dimensional itinerant chiral magnet. 2013. arXiv.
- Rahmani, A., T. Kitagawa, E. Demler, and C. Chamon. Cooling through optimal control of quantum evolution. 2013. *Physical Review A*. 87 (4): 043607.
- Rahmani, A., and G. Chern. Universal Rényi mutual information in classical systems: The case of kagome ice. 2013. *Physical Review B*. 88 (5): 054426.
- Roy, D.. Cascaded two-photon nonlinearity in a one-dimensional waveguide with multiple two-level emitters. 2013. *Scientific Reports*. 3: 02337.
- Roy, D.. Two-photon scattering of a tightly focused weak light beam from a small atomic ensemble: An optical probe to detect atomic level structures. 2013. *Physical Review A*. 87 (6): 063819.
- Roy, D., C. J. Bolech, and N. Shah. Nature of the zero-bias conductance peak associated with Majorana bound states in topological phases of semiconductor-superconductor hybrid structures. 2013. Arxiv .
- Roy, D., L. Yang, S. Crooker, and N. Sinitsyn. Cross-correlation spin noise spectroscopy of heterogeneous interacting spin systems. 2014. arXiv.
- Roy, D., N. Bondyopadhyaya, and S. Tewari. Topologically trivial zero-bias conductance peak in semiconductor Majorana wires from boundary effects. 2013. *Physical Review B*. 88 (2): 020502.
- Roy, D., Y. Li, A. Greilich, Y. Pershin, A. Saxena, and N. Sinitsyn. Spin noise spectroscopy of quantum dot molecules. 2013. *Physical Review B*. 88 (4): 045320.
- Roy, D., and N. Bondyopadhyaya. Statistics of scattered

-
- photons from a driven three-level emitter in a one-dimensional open space. 2014. *Physical Review A*. 89 (4): 043806.
- Savukov, I., T. Karaulanov, and M. G. Boshier. Ultra-sensitive high-density Rb-87 radio-frequency magnetometer. 2014. *Applied Physics Letters*. 104 (2): 023504.
- Savukov, I., and T. Karaulanov. Magnetic-resonance imaging of the human brain with an atomic magnetometer. 2013. *Applied Physics Letters*. 103 (4): 043703.
- Savukov, I., and T. Karaulanov. Anatomical MRI with an atomic magnetometer. 2013. *Journal of Magnetic Resonance*. 231: 39.
- Savukov, I., and T. Karaulanov. Multi-flux-transformer MRI detection with an atomic magnetometer. *Journal of Magnetic Resonance*.
- Shimada, H., J. L. Jacobsen, and Y. Kamiya. Phase diagram and the strong-coupling fixed point in the disordered $O(n)$ loop model. 2013. *Journal of Physics A*. 47: 122001.
- Ten, Y. Y., C. C. J. Wang, M. Graf, and J. X. Zhu. Emergent topological phases in band insulators with crystal field split t_{2g} orbitals. 2014. arXiv.
- Torrontegui, E., S. Ibáñez, S. Martínez-Garaot, M. Modugno, A. del Campo, D. Guéry-Odelin, A. Ruschhaupt, X. Chen, and J. G. Muga. Chapter 2 - Shortcuts to Adiabaticity. 2013. In *Advances in Atomic, Molecular, and Optical Physics*. Edited by Arimondo, E., P. R. Berman, and C. C. Lin. Vol. Volume 62, p. 117. -: Elsevier.
- Wang, C. C. J., J. P. Julien, and J. X. Zhu. Local electronic structure around a single impurity in an Anderson lattice model for topological Kondo insulators. 2014. arXiv.
- White, A., S. Tretiak, and M. Galperin. Raman scattering in molecular junctions: a pseudoparticle formulation. 2014. *Nano Letters*. 14 (2): 699.
- White, C. E., N. J. Henson, L. L. Daemen, M. Hartl, and K. Page. Uncovering the True Atomic Structure of Disordered Materials: The Structure of a Hydrated Amorphous Magnesium Carbonate ($MgCO_3 \cdot 3D_2O$). 2014. *Chemistry of Materials*. 26 (8): 2693.
- White, C., G. J. Kearley, J. Provis, and D. Riley. Inelastic neutron scattering analysis of the thermal decomposition of kaolinite to metakaolin. 2013. *Chemical Physics*. 427: 82.
- Zhang, Z., K. Wierschem, I. Yap, Y. Kato, C. Batista, and P. Sengupta. Phase diagram and magnetic excitations of anisotropic spin-one magnets. 2013. *Physical Review B*. 87 (17): 174405.

Non-Equilibrium Phenomena in Materials, Fluids, and Climate

Robert E. Ecke
20130728DR

Introduction

This project develops collaborative scientific progress at the interfaces of hard materials, soft condensed matter physics, and fluid dynamics. In particular, we consider the structure and properties of disordered materials with emphasis on the role of topological defects, for example dislocations. We are exploring the connection between the behaviors of materials under shear with “universal” scenarios developed in the context of glasses and granular materials as well as more recently in the context of plastic flow via dislocations and thermally activated avalanches. We will measure the pair distribution function of geopolymers using neutron scattering and compare with molecular dynamics simulations. We will look for similarities between the transition from reversibility to irreversibility in materials under shear and soft condensed matter systems such as colloidal suspensions. Reversible and irreversible behavior and the associated kinetics are at the heart of the complex hysteresis and metastability governing the microstructure of materials that have been shocked. We are attempting to describe the universal behavior of phase transforming materials subjected to extremes by departing from the traditional approach of using equilibrium phase diagrams and notions and emphasize the importance of shear. We will understand and characterize how granular material properties can affect earthquake dynamics. We will relate laboratory experiments in rotating and/or stratified flows to asymptotically exact mathematical predictions and to applications in regional climate models such as heat transport in arctic oceans. Our external collaborations enable the cooperative study of porous media flows relevant to carbon sequestration, the exploration of turbulent mixing in the oceans, the description and characterization of radiation damage in materials, and the integration of perspectives on elastic-plastic deformation from both hard and soft matter points of view. These projects support LANL strategic goals in materials, in energy and climate, and in materials under extreme conditions.

Benefit to National Security Missions

The materials research that we propose is squarely in the mesoscopic regime where the discreteness of, for example, dislocations at atomistic scales encounters the elastic plastic continuum at macroscopic scales. This area is an important foundation for the MaRIE program and is applicable to recent DOE/BES priorities in fundamental materials research. Advances in this area would lead to better understanding and modeling of materials, allowing new applications. Improving our understanding of turbulence is relevant to the weapons program.

Progress

In our work on non-equilibrium phenomena in materials we considered a fundamental problem in the physics of amorphous materials namely the understanding of the transition from reversible to irreversible plastic behavior and its connection to yield. Currently, continuum material modeling relies on phenomenological yield thresholds. In many cases, however, the transition from elastic to plastic behavior is gradual, making it difficult to identify an exact yield criterion. In a paper published in *Physical Review E*, we demonstrated that under periodic shear, amorphous solids undergo a transition from repetitive, predictable behavior to chaotic, irregular behavior as a function of the strain amplitude. In both the periodic and chaotic regimes, localized particle rearrangements were observed. We associated the point of transition from repetitive to chaotic behavior with the yield strain and suggest that, at least for oscillatory shear, yield in amorphous solids is a result of a “transition to chaos.” In other more applied work on materials, reported in the *Chemistry of Materials*, we used neutron scattering and quantum chemistry approaches to examine the properties of amorphous calcium/magnesium carbonates which are of significant interest in the technology sector for a range of processes, including carbon storage and biomineralization. The atomic structure of one hydrated amorphous magnesium carbonate (AMC) were investigated using an iterative methodology, where quantum

chemistry and experimental total neutron scattering data are combined in an interactive iterative manner to produce an experimentally valid structural representation that is thermodynamically stable. The atomic structure of this hydrated structure is heterogeneous owing to the presence of regions interspersed with small ‘ pores’ of water molecules. This heterogeneity at the atomic length scale is likely to contribute to the dehydration of hydrated AMC by providing a route for water molecules to be removed. We show that this methodology enables wide sampling of the potential energy landscape, which is important for elucidating the atomic structure of highly disordered metastable materials.

In our work on non-equilibrium phenomena in fluids, published in *Physics of Fluids*, we investigated the direct turbulent enstrophy (mean-square vorticity) cascade of two-dimensional decaying turbulence in a flowing soap film channel. This system is a laboratory analog for geophysical systems such as the ocean or atmosphere where the depth is small compared to the lateral extent. We used a coarse-graining approach that allowed us to resolve the nonlinear dynamics and scale-coupling simultaneously in space and in scale. We presented experimental evidence that enstrophy cascades to smaller (larger) scales with a 60% (40%) probability, in support of theoretical predictions. We used a coherent structure identification technique which allowed us to determine the effect of flow topology on the enstrophy cascade: swirling (stretching) regions are less (more) efficient at enstrophy transfer. In research published in the *Journal of Fluid Mechanics*, we considered another problem of geophysical importance associated with the global transport of heat and salinity in the ocean. The north Atlantic overflows represent choke points in the global circulation in which mixing and entrainment of waters of different densities and temperatures plays a major role in defining the character of the global circulation. Motivated by characterizing natural gravity currents such as oceanic overflows, we performed experimental measurements of a wall-bounded gravity current. We simultaneously measured the velocity and density fields as they evolve downstream of the initial injection from a turbulent channel flow onto a plane inclined at 10 degrees with respect to horizontal. The turbulence level of the input flow is controlled by injecting velocity fluctuations upstream of the output nozzle. The initial Reynolds number (a quantitative measure of the turbulence) was varied and the effects of the initial turbulence level were assessed. The Richardson number Ri measures the competition between destabilizing shear and stabilizing density stratification. In these experiments, the Ri is small, indicating that shear dominates the stabilizing effect of stratification. Hydrodynamic instability results in vigorous vertical

transport of mass and momentum. We obtained the fluid entrainment coefficient E , a quantity of considerable interest in mixing parameterization for ocean circulation models. We also determined the properties of mixing as represented by other geophysically important dimensionless number and found reasonable agreement with results from natural flows.

Future Work

The overall structure of our work is in Structural Materials, Soft Condensed Matter Systems, and in Fluids and Climate. We seek synergistic efforts to emerge among topics but report our directed tasks in each area:

Structural Materials

We will 1) Explore complex hysteretic and metastable behavior in driven systems, including the role of topological defects in phase transformations and in elastic-plastic deformation; 2) Characterize glassy polymers using a combination of experimental neutron scattering PDF measurements and molecular dynamics simulations; and 3) Investigate novel properties and functions of geometrically frustrated materials.

Soft Condensed Matter Systems

We will 1) Develop models of the structural properties of bio-polymers such as DNA; 2) Explore sheared granular media and its relationship to earthquake dynamics; and 3) Investigate the reversibility transition, discovered in particle-fluid systems, for weakly sheared disordered materials.

Fluids and Climate

We will 1) Investigate mass transport properties of porous media flows, including differences between 2D and 3D geometries and comparisons with numerical simulations; 2) Measure heat transport, test asymptotic scaling in rotating Rayleigh-Bénard convection, and visualize vortical columns that transport heat; and 3) Explore how ocean phenomena at multiple length and time scales accumulate to produce the large-scale circulation responsible for the heat and tracer transport affecting the global climate.

Conclusion

The goals of this project are to develop collaborative scientific progress at the interfaces of hard materials, soft condensed matter physics, and fluid dynamics. We will develop models to connect to fundamental experiments, build theoretical frameworks, and perform mathematical analysis and computer simulations. We expect our results to impact applications such as geophysical fluid dynamics related to climate modeling.

Publications

Aluie, H.. Scale decomposition in compressible turbulence.

2013. *Physica D: Nonlinear Phenomena*. 247 (1): 54.
- Barros, K., and W. Klein. Liquid to solid nucleation via onion structure droplets. 2013. *Journal of Chemical Physics*. 139 (17): 174505.
- Ben-Naim, E., and P. L. Krapivsky. Discrete analogue of the Burgers equation. 2012. *Journal of Physics A: Mathematical and Theoretical*. 45 (45): 455003.
- Beylkin, G., and T. S. Haut. Nonlinear approximations for electronic structure calculations. 2013. *Proceedings of the Royal Society A*. 469 (2158): 20130231.
- Chern, C. W., M. Morrison, and C. Nisoli. Degeneracy and criticality from emergent frustration in artificial spin. 2013. *Physical Review Letters*. 111 (17): 177201.
- Chern, G. W., C. Reichhardt, and C. J. Olson Reichhardt. Avalanches and disorder-induced criticality in artificial spin ices. 2014. *New Journal of Physics*. 16 (6): 063051.
- Chern, G. W., C. Reichhardt, and C. Nisoli. Realizing three-dimensional artificial spin ice by stacking planar nanoarrays. 2014. *Applied Physics Letters*. 104 (1): 013101.
- Christov, I., R. Lueptow, J. Ottino, and R. Sturman. A study in three-dimensional chaotic dynamics: granular flow and transport in a bi-axial spherical tumbler. 2014. *SIAM Journal on Applied Dynamical Systems*. 13 (2): 901.
- Christov, I., and H. A. Stone. Shear dispersion in dense granular flows. 2014. *Granular Matter*. 16 (4): 509.
- Christov, I., and P. M. Jordan. On an instability exhibited by the ballistic-diffusive heat conduction model of Xu and Hu. 2014. *Proceedings of the Royal Society A*. 470 (2161): 20130557.
- Chu, H., C. Zhou, J. Wang, and I. J. Beyerlein. An Analytical Model for the Critical Shell Thickness in Core/Shell Nanowires Based on Crystallographic Slip. 2013. *J. 61 (11): 2147*.
- Ecke, R., and J. Niemela. Heat transport in the geostrophic regime of rotating Rayleigh-Bernard convection. 2014. *Physics Review Letters*. 113: 114301.
- Eyink, G., E. Vishniac, C. Lalescu, H. Aluie, K. Kanov, K. Bürger, R. Burns, C. Meneveau, and A. Szalay. Flux-freezing breakdown in high-conductivity magnetohydrodynamic turbulence. 2013. *Nature*. 497 (7450): 466.
- Geller, D., R. Ecke, K. Dahmen, and S. Backhaus. Brittle and non-brittle stick-slip behavior in a continuum-granular earthquake experiment. *Physical Review Letters*.
- Gilbert, I., G. W. Chern, S. Zhang, L. O'Brien, B. Fore, C. Nisoli, and P. Schiffer. Emergent ice rule and magnetic charge screening from vertex frustration in artificial spin ice. 2014. *Nature Physics*. 10 (9): 670.
- Gupta, S., and A. Saxena. Negative Gaussian curvature distribution in physical and biophysical systems—Curved nanocarbons and ion-channel membrane proteins. 2012. *Journal of Applied Physics*. 112 (11): 114316.
- Haut, T. S., T. Babb, P. G. Martinsson, and B. A. Wingate. A high-order scheme for solving wave propagation problems via the direct construction of an approximate time-evolution operator. 2014. arXiv.
- Haut, T., and B. Wingate. An asymptotic parallel-in-time method for highly oscillatory PDEs. 2014. *SIAM Journal of Scientific Computing*. 36 (2): A693.
- Hyman, J. D., and C. L. Winter. Stochastic generation of explicit pore structures by thresholding Gaussian random fields. 2014. *Journal of Computational Physics*. 277: 16.
- Kent, J., J. P. Whitehead, C. Jablonowski, and R. B. Rood. Potential Vorticity: A diagnostic tool for general circulation models. Presented at Solution of Partial Differential Equations on the Sphere (PDEs on the sphere). (Oxford, 24-28 Sept. 2012).
- Khare, A., I. Christov, and A. Saxena. Successive phase transitions and kink solutions in ϕ_8 , ϕ_{10} , and ϕ_{12} field theories. 2014. *Physical Review E*. 90 (2): 023208.
- Khare, A., and A. Saxena. Linear superposition for a class of nonlinear equations. 2013. *Physical Letters A*. 377 (39): 2761.
- Khare, A., and A. Saxena. Superposition of elliptic functions as solutions for a large number of nonlinear equations. 2014. *Journal of Mathematical Physics*. 55 (3): 032701.
- Nisoli, C., D. Abraham, T. Lookman, and A. Saxena. Quasi-one-dimensional thermal breakage. 2013. *Physical Review E*. 88 (4): 042409.
- Nisoli, C., and A. R. Bishop. Attractive inverse square potential, $U(1)$ gauge, and winding transitions. 2014. *Physical Review Letters*. 122 (7): 070401.
- Odier, P., J. Chen, and R. Ecke. Entrainment and mixing in a laboratory model of oceanic overflow. 2014. *Journal of Fluid Mechanics*. 746: 498.
- Provis, J., A. Hajimohammadi, C. White, S. Bernal, R. Myers, R. Winarski, V. Rose, T. Proffen, A. Llobet, and J. J. van Deventer. Nanostructural characterization of geopolymers by advanced beamline techniques. 2013. *Cement and Concrete Composites*. 36: 56.

- Regev, I., T. Lookman, and C. Reichhardt. Onset of irreversibility and chaos in amorphous solids under periodic shear. 2013. *Physical Review E*. 88 (6): 062401.
- Regev, I., and C. Reichhardt. Rheology and shear band suppression in particle and chain mixtures. 2013. *Physical Review E*. 87 (2): 201.
- Reichhardt, C., D. Ray, and C. J. Olson Reichhardt. Collective transport properties of driven skyrmions with random disorder. 2014. arXiv.
- Reichhardt, C., J. Drocco, C. J. Reichhardt, and A. R. Bishop. Statics and Dynamics of Vortex Matter with Competing Repulsive and Attractive Interactions. 2013. *Journal of Superconductivity and Novel Magnetism*. : 1.
- Rivera, M., H. Aluie, and R. Ecke. The direct enstrophy cascade of two-dimensional soap film flows. 2014. *Physics of Fluids*. 26 (5): 055105.
- Siena, M., J. D. Hyman, A. Guadagnini, M. Riva, P. Gouze, P. Smolarkiewicz, C. L. Winter, F. Inzoli, G. Guodon, and E. Colombo. Comparative analysis of methods for pore-scale numerical modeling of fully-saturated flow in natural porous media. *Computational Geoscience*.
- Wang, J., R. Zhang, C. Zhou, I. Beyerlein, and A. Misra. Characterizing interface dislocations by atomically informed Frank-Bilby theory. 2013. *Journal of Materials Research*. 28 (13): 1646.
- Wang, X., and J. Whitehead. A bound on the vertical transport of heat in the 'ultimate' state of slippery convection at large Prandtl numbers. 2013. *Journal of Fluid Mechanics*. 729: 103.
- White, C., G. Kearley, J. Provis, and D. Riley. Structure of kaolinite and influence of stacking faults: Reconciling theory and experiment using inelastic neutron scattering analysis. 2013. *The Journal of Chemical Physics*. 138 (19): 4501.
- White, C., J. Provis, B. Bloomer, N. Henson, and K. Page. In situ X-ray pair distribution function analysis of geopolymer gel nanostructure formation kinetics. 2013. *Physical Chemistry Chemical Physics*. 15 (22): 8573.
- White, C., K. Page, N. Henson, and J. Provis. In situ synchrotron X-ray pair distribution function analysis of the early stages of gel formation in metakaolin-based geopolymers. 2013. *Applied Clay Science*. 73: 17.
- Whitehead, J. P., T. Haut, and B. Wingate. The effect of two distinct fast time scales in the rotating stratified Boussinesq equations. *Nonlinearity*.
- Zhao, L.. Bounce averaged diffusion coefficients in a physics based magnetic field geometry from RAM-SCB . Presented at GEM 2014 Summer Workshop. (Portsmouth, Virginia, 15-20 Jun. 2014).
- Zhao, L.. Bounce averaged diffusion coefficients in a physics based magnetic field geometry from RAM-SCB . Presented at 56th Annual Meeting of the APS Division of Plasma Physics. (New Orleans, 27-31 Oct. 2014).
- Zhao, L.. Bounce averaged diffusion coefficients in a physics based magnetic field geometry from RAM-SCB . Presented at 2014 AGU Fall Meeting. (San Francisco, 15-19 Dec. 2014).
- Zheng, Z., B. Guo, I. Christov, M. Celia, and H. Stone. Flow regimes for fluid injection into a confined porous medium. To appear in *Journal of Fluid Mechanics*.
- Zheng, Z., I. Christov, and H. Stone. Influence of heterogeneity on second-kind self-similar solutions for viscous gravity currents. 2014. *Journal of Fluid Mechanics*. 747: 218.
- Zhou, C., J. Su, M. Graf, C. Reichhardt, A. Balatsky, and I. Beyerlein. Plastic response of dislocation glide in solid helium under dc strain-rate loading. 2013. *Physical Review B*. 88 (2): 4513.

Photoactive Energetic Materials for Quantum Optical Initiation

Robert J. Scharff
20140005DR

Introduction

This project provides an innovative approach to establish design principles and a scientific methodology for generating photoactive energetic materials with controllable optical functionality. The project aims to increase the controllability of chemical dynamics in novel photoactive materials through a concerted experimental and theoretical effort that characterizes the dynamics of energy localization, chemical bond activation, and chemical reactions. This approach will provide critical insight on how to manipulate electronic structure through synthesis in order to generate the desired material response to overcome mechanisms that limit controllability. The authors propose a three part solution for the successful design of photoactive energetic materials for quantum optical initiation. The first part involves the development of new explosives derivatized with an optical chromophore. The optimization of optical response properties (e.g. 1-photon and 2-photon absorption cross-sections and resonant wavelengths) of the photon absorbing chromophore will enable efficient coupling of the laser field to the explosive and facilitate control of excited state dynamics. The second part addresses the need for the elucidation of electron-vibrational dynamics following photoexcitation. Our feasibility studies support our main idea that exothermic NO₂ formation could be achieved photochemically: following absorption, photochemistry can be accomplished through non-adiabatic conversion of the excess electronic energy into specific vibrational degrees of freedom on the explosive and controlling the onset of exothermic chemical reactions in the surrounding material. The third part of the proposal uses fs laser pulse shaping quantum control to optimize photodissociation quantum yields and photoinitiation exothermic chemistry. The achievement of optically driven control over the chemical reaction dynamics of energetic materials will not only have an immediate and profound impact on the Weapons Program, but will also provide significant advancements towards utilizing laser pulses as powerful sources for manipulating and control-

ling atomic and molecular processes on unprecedented time and length scales.

Benefit to National Security Missions

The overarching goal of this project – to achieve quantum control of explosive initiation – utilizes the theory-guided, materials-by-design approach outlined in the Materials Pillar Extreme Environments theme of “predicting and controlling functionality of materials in these extremes”. Critical to the Materials Pillar mission is the establishment of design principles and scientific protocols for manufacturing advanced materials to control functionality for predefined performance criteria central to LANL mission needs. DOE programmatic drivers exist for the development of photoactive energetic materials that can address future milestones for enhanced safety, security, and use-control of the nuclear stockpile. Moreover, there are DoD directives for the development of new energetic materials that are insensitive to unplanned stimuli (e.g., spark, impact, and friction). The development of photoactive energetic materials that optically initiate through quantum controlled photochemistry would yield a “quantum lock-and-key” capability valuable not only in applications for improved detonator optical isolation, but also for enhancement of use-control protections, explosive optical logic, and other dual-use technologies to support initiatives concerning DoD insensitive munitions or planned Life Extension Programs.

Progress

We have made considerable progress during the first 12 months of the project towards our primary goal of designing and developing new energetic materials with controllable photochemical reactions.

Synthesis and Characterization Efforts

Tetrazine heterocycles, which ideal energetic chromophores, have been synthetically linked to the conventional energetic materials Pentaerythritol tetranitrate

(PETN) and 3,3- dinitroazetidine (DNAZ) yielding significant changes to their photochemistry. UV-VIS molar absorptivity and diffuse absorbance spectroscopy were used with Raman scattering and infrared spectroscopies to characterize and investigate the photoreactivity of these chromophore linked energetic materials. Quantification of the single photon quantum yields is in progress. Several compositions of energetic materials that are photoactive or are expected to be photoactive and undergo photoinitiation when exposed to suitable wavelengths of light in the ultraviolet and/or visible region of the electromagnetic spectrum have been synthesized. Some of the energetic materials were described by Chavez et al. in "Electroactive Explosives: Nitrate Ester-Functionalized 1,2,4,5-Tetrazines," *Angew. Chem. Int. Ed.*, 2013, vol. 52, pp. 6876-6879. These new results are currently being summarized in an article to be submitted later this summer.

Additionally, the Patent Application S-133,036 has been filed.

Theory and Simulation Efforts

Vibrational and UV-Vis spectra have been computed using modern density functional theoretical methods for 11 new energetic molecules and prove to be in excellent agreement with our experimental results. This allows us to benchmark for higher level dynamics calculations that are already in progress.

We have computed the non-adiabatic excited state dynamics of several new molecules including PETN-Tz-Cl and DNAZ-Tz-Cl. These results are currently being summarized in an article to be submitted later this summer.

Presentations of this work have or will be made this FY at:

Excited State Processes 2014, Gordon Research Conference for Energetic Materials, and the 15th International International Detonation Symposium

Future Work

On going development of optical explosives

Synthesis: Synthesis efforts will focus on pi extended conjugated systems in an effort to increase cross sectional areas of the molecule. Efforts will also focus on polycyclic materials in an effort to increase polarizability. We will also begin to scale-up molecules we have created in FY14.

Theory: Currently we are benchmarking the non-adiabatic dynamics with solvent using well studied model systems. In the next year this means we will be able to perform non-adiabatic dynamics simulations of our target molecules using solvent environment.

Characterization: We will perform CW laser photo degrada-

tion, fluorescence quantum yield and spectral measurements, and measure the optical absorption of the remaining newly synthesized photoactive energetic materials to identify the one photon active excited states and use FTIR to measure the photo decomposition chemistry. We will begin time resolved photochemical measurements (FSRS) on the novel photoactive HE. We will begin to measure two photon absorption spectra of photoactive HE in solution for comparison and validation to theory.

Conclusion

As the primary goal is the design and development new energetic materials with controllable photochemical reactions, the expected outcome is a transformational and universal paradigm for the development of advanced future materials with structure-function relationships leading to applications based on quantum control of chemistry. The development of photoactive energetic materials that initiate through the quantum control of photochemistry addresses future surety themes outlined in the FY12 Stockpile Stewardship and Management Plan and provides an enabling technology for future Directed Stockpile Work. The project will pave the way for new explosives that perform like RDX yet are insensitive to unplanned stimuli.

Publications

- Alfonso-Hernandez, L., T. Nelson, S. Tretiak, and S. Fernandez-Alberti. Coherent photoexcited energy transfer in a weakly coupled dimer. *Journal of Physical Chemistry A*.
- Bjorgaard, J. A., V. Kuzmenko, K. A. Velizhanin, and S. Tretiak. Solvent effects in time-dependent self-consistent field methods I: optical response calculations. *Journal of Chemical Physics*.
- White, A. J., V. N. Gorshkov, R. Wang, S. Tretiak, and D. Mozyrsky. Semiclassical Monte-Carlo: A First Principles Approach to Non-adiabatic Molecular Dynamics. To appear in *Journal of Chemical Physics*.

Multiferroic Response Engineering in Mesoscale Oxide Structures

Quanxi Jia
20140025DR

Introduction

Multiferroic (MF) materials exhibit strongly coupled magnetic and ferroelectric (FE) orders and promise transformative technologies in energy, security, and information processing. However, the inability to synthesize epitaxial materials with the desired three-dimension (3D) structure and to probe the emergent properties resulting from the atomic-to-mesoscale evolution poses significant challenges to modern condensed matter theory in providing a predictive description of the strong coupling among spin, charge, orbital, and lattice degrees of freedom. As a result, new materials discovery has often relied on serendipitous findings rather than on scientific principles underpinning the magnetoelectric (ME) functionality. We target to use a systematic co-design approach to the discovery of MFs based on a closed synthesis-characterization-modeling loop. We emphasize the rapid feedback from the experimental validation to theoretical prediction and vice versa. Our approach is enabled by a combination of recent LANL breakthroughs in first-principles modeling of complex electron correlation phenomena, controllable synthesis of 3D mesoscale films, and novel coherent photon probes of intrinsic dynamics of competing orders in MF composites.

Built on our team's unique expertise in theoretical simulation of multifunctional metal-oxide materials, the effort starts with ab-initio identification of prominent composite structures having high ME response. Experimental results is then used to refine model Hamiltonians and to provide a better estimate for the geometry and constituent materials, quite possibly beyond the initial compounds and structures, for the next optimization iteration. For a particular choice of materials ($\text{BiFeO}_3:\text{CoFe}_2\text{O}_4$ or $\text{La}_{0.7}\text{Sr}_{0.3}\text{MnO}_3:\text{BiFeO}_3$), we synthesize these epitaxial 3D composite films and systematically characterize their structural and physical properties.

Benefit to National Security Missions

This project aims to develop basic principles to control macroscale multiferroic (MF) functionality in mesoscale composites through tuning the interactions on the nanoscale. This research directly supports all three central themes of the Materials for the Future pillar in harnessing defects, interfaces and electromagnetic field extremes to control collective behavior in MF materials. Our approach also addresses LANL's priorities in 'meso'-science development and practical realization of design principles towards both tunable and controlled functionality of complex materials. The proposed effort aligns well with the MaRIE vision of 'material co-design' and develops new integrated capabilities in synthesis, theory, and ultrafast x-ray characterization for MaRIE. This project further leverages the user programs at LCLS, APS, CINT, NMFML, and the Lujan Center in accord with the LANL institutional priority in supporting national user facilities. Materials with tunable functionality are enabling components in energy, sensing, and information technologies. Therefore, we expect this work to have a direct and significant impact on near- and long-term LANL programs in Advanced Materials, Global Security, Information Science and Technology, and Clean Energy.

Progress

The progress in the last review period is tremendous from all aspects. We synthesized enough samples for advanced characterization. The theoretical team has provided us guidance to design materials systems with desired functionalities. The co-design loop is working effectively. In the following, we highlight some important results resulted from this review period.

In the theoretical side, we have i) developed a systematic approximation that allows DFT calculations of nanopillar structures that interface transition metal-oxide (TMO) materials. The large unit cell size of relevant TMO materials makes such calculations impossible without such an approximation; and ii) employed the developed

approximation to perform DFT calculations on nanopillar structures combining BiFeO₃ (BFO) with La_{1-x}Sr_xMnO₃. The values for x are chosen according to the systems under investigation in this project's experimental component. For x>0, the multiple arrangements of Sr within the La_{1-x}Sr_xMnO₃ components are under investigation. The calculated quantities (formation energy, charge structure, magnetic structure) inform us which interface structures are more favored and why. These theoretical works have been used to guide the materials design and to understand the experimental results.

Using our controlled synthesis, we have grown several materials with desired architectures. These materials systems are not only systematically characterized by the conventional tools. Importantly, these materials have been analyzed by our advanced probing techniques.

Because the structures and properties of nanocomposites vary over nm-length-scales, probes that are intrinsically sensitive to such variations are crucially important in order to understand the origins of meso and macro-scale response of nanocomposites. In this review period, we have applied polarized neutron reflectometry and x-ray resonant magnetic reflectometry to two nanocomposite systems. Remarkably, we found using polarized neutron reflectometry that in the superlattice system (and not as a single film), anti-ferromagnetic BFO exhibits a net uncompensated magnetization that is opposite to the magnetization of the La_{0.7}Sr_{0.3}MnO₃ (LSMO). Further the temperature dependence of the BFO magnetization is the same as the LSMO. We believe antiferromagnetic exchange coupling between Mn and Fe spins across the LSMO/BFO interface stabilizes a canted antiferromagnetic structure in BFO. The degree of canting is related to the magnetization of LSMO.

Using our extensive ultrafast spectroscopic capabilities and expertise in the physics of complex materials, we have made substantial progress towards the goals of this project. In particular, our initial experimental efforts have focused on elucidating the dynamic coupling between ferromagnetic and ferroelectric/antiferromagnetic orders. Using ultrafast optical spectroscopy, we showed that exchange bias coupling leads to emergence of interfacial antiferromagnetic order in La_{0.7}Ca_{0.3}MnO₃ (LCMO). This non-native spin order strongly affects charge transport in LCMO making polaronic (coupled charge-lattice quasiparticles) behavior the likely origin of tunable magnetotransport upon switching the ferroelectric polarity in a LCMO/BFO heterostructure. We have unveiled this through measuring the difference in dynamic spectral weight transfer between LCMO and LCMO/BFO at low temperatures, which indicated polaronic nature of charge transport in LCMO/BFO. The polaronic feature in LCMO/BFO decreased in relatively

high magnetic fields due to the increased spin alignment, while no discernible change was found in the LCMO film at low temperatures.

Regarding new capability, we also made good progress. The figure of merit for magnetoelectric coupling can be measured using fast pulsed magnetic fields, which give improved signal to noise over DC measurements, and access high magnetic field states that provide important information about energy scales and magnetic ordering. We have developed a method for measuring thin film and heterostructured multiferroics in high magnetic fields, which minimizes eddy current heating, and reduces the risk of pinhole conductivity. New methods for high-frequency dielectric constant measurements in pulsed fields utilizing high-speed field-programmable gate arrays for rapid capacitance bridge balancing are being explored.

Future Work

Theory: We will continue to use density functional theory (DFT) to advance our understanding at the smallest scale of the materials systems under investigation. We will also perform DFT calculations to systematically probe for multiferroic phenomena in chemical variations of the prototype incommensurate-superlattice systems that shows both ferromagnetism and ferroelectricity. We will further analyze our results to uncover systematic behavior that depend on the composition in the heterostructures, with focus on magnetic structure, ferroelectricity, and interfacial strain.

Synthesis: We will use laser molecular beam epitaxy to synthesize both 3D multiferroic architectures with desired structural properties. Both vertically aligned epitaxial BiFeO₃:CoFe₂O₄ and BaTiO₃:CoFe₂O₄ films with appropriate volume ratios as determined by the theoretical modeling will be extensively investigated. To establish the baseline, we will also grow and study the layered structures and single layer films. To systematically manipulate the strain state in the nanocomposites, we will further vary the film thickness and substrate materials.

Advanced Characterization: The films synthesized will be systematically studied not only by the conventional characterization techniques but also by the advanced probing tools such as neutron diffraction and magnetoelectric measurements at high magnetic fields. We will apply time-integrated and time-resolved optical tools, covering the terahertz (THz) through the x-ray frequencies, to investigate the mechanisms underlying magnetoelectric functionality in these materials. We will also perform static x-ray magnetic circular dichroism (XMCD) experiments in order to directly probe spin alignment on particular magnetic ions as a function of composition. We have secured access to small angle neutron instruments at Oak Ridge National

Lab and the National Institute of Standards and Technology.

Conclusion

We expect to identify an optimal geometry of 3D composites and develop initial concepts underpinning their functionality. Continuous iterations through co-design loop will result in better understanding of the ME functionality in 3D structures. We anticipate to delivering a complete theoretical suite for reliable prediction of MF functionality in any possible 3D geometry and materials combination. When combined with refined 3D synthetic and characterization tools, we expect to develop a complete set of capabilities for accelerated materials discovery that will be applicable to a broad class of correlated electron materials, well beyond the MF heterostructures.

Publications

- Atkins, R., M. Dolgos, A. Fiedler, C. Grosse, S. Fischer, S. P. Rudin, and D. C. Johnson. Synthesis and Systematic Trends in Structure and Electrical Properties of $[(\text{SnSe})_{1.15}]_m(\text{VSe}_2)_1$, $m = 1, 2, 3$, and 4. 2014. *Chemistry of Materials*. 26: 2862.
- Choi, E. M., T. Fix, A. Kursumovic, C. J. Kinane, D. Arene, S. L. Sahonta, Z. Bi, J. Xiong, L. Yan, J. S. Lee, H. Wang, S. Lamgridge, Y. M. Kim, A. Y. Borisevich, I. MacLaren, Q. M. Ramasse, M. G. Blamire, Q. X. Jia, and J. L. MacManus-Driscoll. Room temperature ferrimagnetism and ferroelectricity in strained, thin films of $\text{BiFe}_{0.5}\text{Mn}_{0.5}\text{O}_3$. To appear in *Adv. Funct. Mater.*
- Dowden, P. C., Z. Bi, and Q. X. Jia. Method for controlling energy density for reliable pulsed laser deposition of thin films. 2014. *Rev. Sci. Instrum.* 85: 025111.
- Jain, P., Q. Wang, M. Roldan, A. Glavic, V. Lauter, C. Urban, Z. Bi, T. Ahmed, J. Zhu, J. Zhu, M. Varela, Q. X. Jia, and M. R. Fitzsimmons. Synthetic magnetoelectric coupling in a nanocomposite multiferroic. *Scientific Reports*.
- Jia, Q. X.. Effect of Interfaces on Ferroic Properties of Composite Films. Invited presentation at International Symp. on Emerging Multifunctional & Bio-Directed Mater.. (San Antonio, TX, 10 - 111, Oct.).
- Sandberg, R., B. Mafarland, R. Prasankumar, G. Rodriguez, A. Chen, Q. X. Jia, A. Taylor, D. Yarotski, A. Ried, and H. Ohldag. Probing multiferroic materials with soft X-ray spectroscopy and imaging. Invited presentation at SLAC User Workshop. (Menlo Park, CA, Oct. 10, 2014).
- Sheu, Y. M., S. A. Trugman, L. Yan, J. Qi, Q. X. Jia, and A. J. Taylor. Polaronic transport induced by competing interfacial magnetic order in a $\text{La}_{0.7}\text{Ca}_{0.3}\text{MnO}_3/\text{BiFeO}_3$ heterostructure. 2014. *Phys. Rev. X*. 4: 021001.
- Sheu, Y. M., S. A. Trugman, L. Yan, Q. X. Jia, A. J. Taylor, and R. P. Prasankumar. Ultrafast optical manipulation of magnetoelectric coupling at a multiferroic interface. *Nature Communications*.
- Sing, S., J. H. Haraldsen, J. Xiong, E. M. Choi, P. Lu, D. Yi, X. D. Wen, J. Liu, H. Wang, Z. Bi, P. Yu, M. R. Fitzsimmons, J. L. MacManus-Driscoll, R. Ramesh, A. V. Balatsky, J. X. Zhu, and Q. X. Jia. Induced magnetization in $\text{La}_{0.7}\text{Sr}_{0.3}\text{MnO}_3/\text{BiFeO}_3$ superlattices. 2014. *Phys. Rev. Lett.* 113: 047204.
- Xiong, J., V. Matias, B. W. Tao, Y. R. Li, and Q. X. Jia. Ferroelectric and ferromagnetic properties of epitaxial $\text{BiFeO}_3\text{-BiMnO}_3$ films on ion-beam-assisted deposited TiN buffered flexible Hastelloy. 2014. *J. Appl. Phys.* 115: 17D913.
- Zhang, W., A. Chen, Z. Bi, Q. X. Jia, J. L. MacManus-Driscoll, and H. Wang. Interfacial coupling in heteroepitaxial vertically aligned nanocomposite thin films: from lateral to vertical control. 2014. *Curr. Opin. Solid State Mater. Sci.* 18: 6.
- Zhang, W., J. Jian, A. Chen, L. Jiao, F. Khatkhatay, L. Li, F. Chu, Q. X. Jia, J. L. MacManus-Driscoll, and H. Wang. Strain relaxation and enhanced perpendicular magnetic anisotropy in $\text{BiFeO}_3\text{:CoFe}_2\text{O}_4$ vertically aligned nanocomposite thin films. 2014. *Appl. Phys. Lett.* 104: 062402.

Exploring Mechanisms of Catalysis on Plutonium Surfaces (U)

Marianne P. Wilkerson
20140051DR

Introduction

Characterization of the molecular rearrangements that occur on metal surfaces can provide insight into important catalytic processes. Uncovering the role a metal surface plays in catalyzing molecular transformations is critical to obtaining a thorough understanding of its performance in a given environment. High-resolution imaging (Atomic Force Microscopy/Scanning Tunneling Microscopy), Secondary Ionization Mass Spectrometry, and Fourier Transform Infrared Absorption Spectroscopy is being applied to characterize molecular and materials states on Pu surfaces, providing unprecedented information about their roles in materials/environment interactions. We are using electronic structure and atomistic methods to model reaction mechanisms. Furthermore, a comprehensive organometallic chemistry study is being conducted to provide complementary information about metal-molecule binding and factors controlling reactivity. Consequently, a science-based reaction kinetic model will be developed to predict the response of Pu surfaces to a variety of molecular environments.

Benefit to National Security Missions

The response of Pu materials to molecular environments is a key component of laboratory missions related to Stockpile Stewardship. Furthermore, the development of the materials science and chemistry of the actinides, particularly Pu, will advance and strengthen our position as the national Plutonium Center of Excellence.

Progress

Experimental

Ultra-high vacuum scanning tunneling microscopy (UHV-STM) will be used to characterize the morphology and defect structure of clean, well-characterized Pu metal and oxide surfaces with atomic-scale resolution. An existing system has been relocated to the Target Fabrication Facility (TFF), a radiological laboratory fully approved for plutonium work. Various aspects of the vacuum system

and microscope have been tested, modified, repaired, or replaced as needed. The STM has been tested in atmosphere and vacuum, and atomic resolution images obtained under both conditions. In preparation for the introduction of Pu samples, a Pu transfer system has been designed and fabricated, and testing of the transfer system is complete.

Atomic Force Microscopy (AFM) will be utilized for study of Pu surface morphology. Properties such as surface topography, roughness, as well as grain boundary size and distribution can be studied, among other properties. Two operational AFM systems were tested and a single instrument was chosen for installation into an isolated, inert glove box currently located at the TFF.

Time-of-Flight Secondary Ion Mass Spectroscopy (ToF-SIMS) characterizes the surface of solids by analysis of high energy ion-induced sputtering. In March of 2014, a 30 mg coupon of delta-stabilized plutonium was introduced into the ToF-SIMS instrument located at the Target Fabrication Facility (TFF) in support of this LDRD. This sample was prepared with standard mechanical polishing techniques at the Chemistry and Metallurgical Chemistry (CMR) facility at LANL, shipped to the TFF, and introduced into the system using a special transfer device that meets the radiological safety requirements of the laboratory. The preliminary data taken from this sample represent the first plutonium SIMS data produced at LANL, and a major milestone in the expansion of plutonium surface science capabilities. In addition to the ToF-SIMS plutonium data, a comprehensive gas dosing stage has been added to the instrument during FY14. The dosing system incorporates a Sieverts type apparatus and a microscope so that visually apparent changes can be recorded during gas exposures, which can be performed up to one atmosphere. The heated sample stub has been tested from ambient temperature to 450 oC.

A Nicolet 6700 Fourier transform infrared (FTIR) spec-

trometer has been established for surface chemistry studies on Pu. The FTIR spectrometer will aid in the identification of surface species and reaction intermediates on metal surfaces. The instrument has been installed in the TFF laboratory, and all services for the instrument are complete. Experiments are ongoing with non-radiological metal samples.

Synthetic Chemistry

Synthesis efforts to elucidate the mechanism on a molecular scale were hampered due to down time associated with a laboratory move from TA46 to TA59 and then the subsequent closure of the new facility for 8 weeks due to concerns about ceiling safety. However, several new cerium complexes supported with bulk ligands were prepared as precursors for studying the reverse water-gas shift reaction and known Ce-H complexes were also synthesized to begin this study. Reactions to gain a deeper mechanistic insight are on-going

Modeling

Current modeling efforts are focused on DFT based modeling of the PuO₂ bulk system and low-index surfaces of PuO₂. We have obtained high performance computational resources appropriate for these simulations and are in the process of validating the use of "DFT+U" methods for surface calculations. An appropriate Hubbard U parameter was fit to match observed band gaps in bulk PuO₂. This value was then used to calculate surface energies and work functions on PuO₂ <100>, <110>, and <111> surfaces. The <110> surface was found to be the lowest energy surface and was used to study the behavior of oxygen vacancies as a four layer <110> surface slab model. No clustering of vacancies in the first <110> layer were observed based on 4 different vacancy configurations and the surface energy minimizing structures were those with vacancies maximally spread. Additionally, Pu-Ga bulk and surface calculations are underway as part of our ongoing work with UT-Arlington (S. Hernandez and R. Atta-Fynn). This work focuses on the importance of spin-orbit coupling in the utilized DFT model as well as Ga concentration effects on the Pu-Ga <111> surface relaxations and has resulted in several publications.

Future Work

The Scanning Tunneling Microscope (STM) system will be commissioned for plutonium during FY15. The first ever STM images of Pu metal surfaces will be acquired. An additional gas manifold system will be constructed and integrated into the system for gas exposure experiments.

The operational mode (contact, tapping modes) of the Atomic Force Microscope (AFM) will be investigated inside the glovebox to ensure the highest quality images are ob-

tained. Ventilation support for the AFM glovebox will also be completed, and the first Pu samples will be imaged.

Experiments will be performed in the Sieverts Reaction Cell to explore the role of iron compounds at the surface of Pu as a catalytic site, and measure the distribution of hydrogen or water-gas shift intermediates with the Secondary Ion Mass Spectrometer (SIMS)

Work on the Diffuse Reflectance Infrared Fourier Transform (DRIFTS) system will progress toward working with radioactive material like polymer-assisted deposited Pu thin films and Pu metal coupons. A Gas Chromatograph/Mass Spectrometer (GCMS) will be commissioned for gas analysis of the infrared diffuse and specular reflection reaction chambers.

Synthesis work will be accelerated and reactions to prove the ability of cerium to facilitate the reverse water-gas shift reaction will be carried out to help determine the mechanism of this reaction. New complexes and intermediates will be synthesized and reaction with appropriate gases will be performed.

Modeling work will focus on further validation of modeling methods via the use of all-electron based codes that include relativistic effects and hybrid exchange-correlation functionals. Vibrational spectra will be calculated which will allow our findings to be directly compared with experimental data, aiding in model validation and experimental interpretation of data. Other surface defect structures (step edges, kinks, etc.) will also be considered.

Conclusion

We will gain a deeper understanding of the fundamental connections that exist between the composition, valence state and structural properties of a given defect center and its propensity for catalysis through the following areas:

- Reaction mechanisms of Pu-catalyzed molecular transformations.
- Science-based predictive kinetic models for Pu catalysis.
- High-resolution imaging of Pu surfaces.
- Inventory of new Pu and surrogate coordination complexes with hitherto unexplored properties.

Publications

Beaux, M. F., T. Durakiewicz, K. S. Graham, J. N. Mitchell, S. Richmond, E. D. Bauer, D. P. Moore, F. J. Freibert, P. H. Tobash, and J. A. Kennison. Electronic structure of polycrystalline d-Pu metal: a review of photoemission spectra interpretations. 2014. In Pu Futures - The 'Science' 2014. (Las Vegas, NV, 7-12 Sept. 2014). , p.

-
- CMP.9. Las Vegas NV: American Nuclear Society.
- Hernandez, S. C., D. S. Schwartz, C. D. Taylor, and A. K. Ray. Ab initio study of Ga-Stabilized d-Pu bulk and surfaces. 2014. In Pu Futures - The 'Science' 2014. (Las Vegas, NV, 7-12 Sept. 2014). , p. M&MS.15. Las Vegas NV: American Nuclear Society.
- Hernandez, S. C., D. S. Schwartz, C. D. Taylor, and A. K. Ray. Ab initio study of gallium stabilized d-plutonium alloys and hydrogen-vacancy complexes. 2014. Journal of Physics: Condensed Matter. 26 (3): 235501/1.
- Hernandez, S. C., and C. D. Taylor. Density functional theory studies on atomic adsorptions on Ga stabilized d-Pu (111) surfaces. 2014. In Materials Research Society 2014 Spring Meeting and Exhibit. (San Francisco, CA, 21-25 April 2014). , p. S6.05. San Francisco CA: Materials Research Society.
- Holby, E. F.. Oxygen vacancies in PuO₂ (110) surfaces via density functional theory. 2014. In Pu Futures - The 'Science' 2014. (Las Vegas, NV, 7-12 Sept. 2014). , p. III. Las Vegas NV: American Nuclear Society.
- Pugmire, A. L., C. H. Booth, T. J. Venhaus, and D. L. Pugmire. Structural insights into the oxide formed during the room temperature corrosion of Plutonium. 2014. In Pu Futures - The 'Science' 2014. (Las Vegas, NV, 7-12 Sept. 2014). , p. SS&C.7. Las Vegas NV: American Nuclear Society.
- Richmond, S., P. H. Tobash, and D. Schwartz. The synthesis of Pu₆Fe from plutonium deuteride and iron powders. 2014. In Pu Futures - The 'Science' 2014. (Las Vegas, NV, 7-12 Sept. 2014). , p. M&MS.13. Las Vegas NV: American Nuclear Society.
- Schwartz, D. S., S. Richmond, C. D. Taylor, A. I. Smith, and A. L. Pugmire. Hydrogen effects in Pu-Ga alloys: defects and thermodynamics. 2014. In Pu Futures - The 'Science' 2014. (Las Vegas, NV, 7-12 Sept. 2014). , p. II. Las Vegas NV: American Nuclear Society.
- Smith, A. I., K. L. Page, S. Richmond, J. Siewenie, T. A. Saleh, M. Ramos, and D. S. Schwartz. Local structural investigation of the Pu-7at%Ga using neutron total scattering. 2014. In Pu Futures - The 'Science' 2014. (Las Vegas, NV, 7-12 Sept. 2014). , p. M&MS.7. Las Vegas NV: American Nuclear Society.
- Sutton, A. D., and M. P. Wilkerson. Catalysis with cerium organometallic complexes. 2014. In Pu Futures - The 'Science' 2014. (Las Vegas, NV, 7-12 September 2014). , p. CCCC.11. Las Vegas NV: American Nuclear Society.
- Venhaus, T. J., and D. P. Moore. Analysis of Pu surfaces with time-of-flight SIMS. 2014. In Pu Futures - The 'Science' 2014. (Las Vegas, NV, 7-12 Sept. 2014). , p. SS&C.8. Las Vegas NV: American Nuclear Society.
- Vegas NV: American Nuclear Society.
- Wagner, G. L., M. T. Paffett, K. D. Rector, B. L. Scott, and M. P. Wilkerson. Characterization of products from hydrolysis of UF₆. 2014. In Pu Futures - The 'Science' 2014. (Las Vegas, NV, 7-12 Sept. 2014). , p. CCCC.4. Las Vegas NV: American Nuclear Society.

Mesoscale Materials Science of Ductile Damage in 4 Dimensions: Towards the Computational Design of Damage-Tolerant Materials

Ricardo A. Lebensohn
20140114DR

Introduction

The failure of structural materials has a significant impact on vast sectors of the economy, including energy, transportation and defense. The costs arise both from rare catastrophic events to the more mundane expenses of over-engineering or preventive part replacement. Consequently, there has been enormous effort in the past to gain fundamental understanding of failure mechanisms and thus enable the development of more reliable components.

Most structural materials are polycrystalline aggregates, in which the constituent crystals are irregular in shape, have anisotropic mechanical properties, and contain a variety of defects. The deformation of these heterogeneous materials results in very dynamic and complicated responses. While centuries of metallurgical experience and post-failure analysis have given us insight into general aspects relating material processing and performance, our failure models remain empirically calibrated because we have yet to achieve a thorough understanding of the controlling processes at the scale of the materials' heterogeneity, i.e. the mesoscale.

This project addresses one of the most difficult outstanding problems in Materials Science: the development of a predictive, microstructure-sensitive ductile failure model. This will be achieved by integrating time-resolved three-dimensional (3-D) microstructural characterization of polycrystalline materials with state-of-the-art modeling and advanced data analysis tools, to ensure maximal and optimal data extraction. Increasingly complex model materials will be used to develop this integrated capability, which will be then tested and applied to the predictive design of damage-tolerant microstructures.

We intend to draw upon existing High Energy Diffraction Microscopy (HEDM) techniques, integrating and combining them with appropriate modeling and data analysis formulations, to discover relationships between micro-

structure and ductile damage in selectively prepared polycrystalline aggregates. We will follow the volumetric deformation through time, i.e. in four dimensions. The proposed integration will allow us to achieve the full inversion of this 4-D data, and extract the controlling aspects of ductile damage.

Benefit to National Security Missions

DOE's Office of Basic Energy Sciences (OBES) has recently highlighted the area of mesoscale science as the next grand-challenge in Materials Science. The two top capability gaps for this were defined as the seamless integration of theory, modeling and simulation with synthesis and characterization, and the dynamic characterization of mesoscale phenomena. This project directly addresses both topics. Success of this paradigm will establish LANL's leadership in this growing initiative, expected to be central to future DOE programs.

The development of improved predictive damage models that incorporate mesostructural sensitivity will be of interest to several Defense Programs (DP) stakeholders. Extension to dynamic regimes will especially extend its application to DP programs. The MaRIE campaigns will be a beneficiary of experience in the development of in-situ diffraction and associated data processing. Application of the integrated approach to material development should attract interest from advanced manufacturing initiatives.

Progress

Experimental

Using powder metallurgy, we have completed two copper plates with fully dense structure with an average grain size on the order of 55 microns. Several tensile specimens were successfully machined from these two plates using wire EDM method.

We submitted, got accepted and executed a General User Proposal (GUP) in Advanced Photon Source (APS)

entitled: “3-D in-situ characterization of ductile damage evolution in polycrystalline materials.” We collected data on a notched Cu sample in tomography, HEDM near-field (nf) and far-field (ff) modes simultaneously. The raw data is now under analysis.

We submitted, got accepted and scheduled for next fall a second APS’s GUP entitled: “Study of microstructural effects on ductile damage evolution in two-phase polycrystalline materials using 3-D in-situ HEDM characterization” to collect similar data in Cu-W and Cu-Nb samples.

Data Analysis

The existing HEDM forward modelling code has been adapted for compressive sensing (CS) reconstruction, producing simulations with only 1-bit accuracy, and we have developed an algorithm for CS reconstruction from 1-bit measurements, based on incorporating non-convex regularization into a previous, convex-based approach. The resulting code was demonstrated to work extremely well on synthetic data. Reconstructions were performed on real calibration HEDM measurements of a ruby sample. We are currently a reconstruction approach to combining spatial-gradient sparsity with orientation sparsity.

FFT-based micromechanical simulations for different initial synthetic configurations are being performed and preliminary calculations of adjoint-based optimization systems are being setup for automatic parameter estimation.

Contributions to data management/visualization aspects include: 1) prototype grain metric algorithms and visualization designs; 2) initial implementation of redesigned data analysis workflow. 3) Specified and purchased hardware to implement a flexible and robust storage solution for all project data. 4) Established central project team forge site to serve as a central repository.

Modelling

We have demonstrated the feasibility of using the viscoplastic FFT model (VPFFT) with direct input from HEDM data.

We have extended the dilatational viscoplastic FFT model (DVPFFT) to consider void growth in polycrystalline materials and applied to the interpretation of microstructural effects on porosity evolution of shocked Cu.

A moment-based method for calculating interface normals in voxelized 3D images has been developed and incorporated in the elasto-viscoplastic (EVPFFT) code. The normal determination is required to investigate microstructural effects on void nucleation. EVPFFT and DVPFFT are being merged.

Future Work

Last year’s HEDM measurements will be analyzed and new experiments will be conducted to measure damage evolution in polycrystalline aggregates synthesized to maximize the extraction of relevant microstructural information. The measured microstructures will be used as input for our improved spectral model, whose predictions and underlying physics will be tested against the measured damage evolution. Once the aforementioned full-field spectral model is calibrated, we will also start exploring novel homogenization-based techniques, which in turn will be validated by comparison with full-field reference solutions, to account for microstructural effects on ductile damage with the efficiency needed for multiscale implementations.

We will continue addressing the major bottleneck of the proposed work, which lies on the difficulty in inverting the low-quality diffraction data arising from heavily deformed and damaged materials. All four proposed strategies we be continued: 1) collecting the synchrotron data simultaneously in tomography, orientation and stress mapping modes; 2) using correlations between multiple snapshots during the deformation process; 3) employing direct simulations; and 4) using compressive sensing and hierarchical sparse representations.

We will capture microstructural and micromechanical information correlated with ductile damage, obtaining HEDM snapshots during quasi-static tensile tests performed on notched bars. The measurements will be performed on a volume of $\sim 0.5 \text{ mm}^3$ in the notch region of the samples. In the second year, we will study polycrystalline Cu-W composites, synthesized by powder metallurgy.

3-D tomographic reconstructions will allow us to detect void formation at early stages of deformation. The grain orientation data will inform us of plastic deformation at the grain scale, in particular near voids, while the local stress mapping will provide information on stress concentrations, which presumably drive void nucleation, and stress relaxations once voids have formed.

Conclusion

Our overarching goal is, by the end of this project, being able to formulate a quantitative, microstructure-sensitive, experimentally-validated mesoscale model of ductile damage, paving the way towards a truly predictive failure model. This will also result in the advancement of novel experimental and analytical techniques that can then be extended and applied to other problems of strategic interest for the Laboratory and the Nation.

Publications

- Anglin, B. S., R. A. Lebensohn, and A. D. Rollett. Validation of a numerical method based on Fast Fourier Transforms for heterogeneous thermoelastic materials by comparison with analytical solutions. 2014. *Computational Materials Science*. 87: 209.
- Bingert, J. F., R. M. Suter, J. Lind, S. F. Li, R. Pokharel, and C. P. Trujillo. High-Energy diffraction microscopy characterization of spall damage. 2014. In *Dynamic Behavior of Materials, Volume 1.*, p. 397. : Springer International Publishing.
- Chartrand, R.. Shrinkage mappings and their induced penalty functions. To appear in *IEEE International Conference on Acoustics, Speech, and Signal Processing 2014*. (Florence, Italy, 4-9 May, 2014).
- Chen, C. F., D. Dombrowski, R. A. Lebensohn, B. Clausen, R. Forsyth, and R. Pokharel. Processing and consolidation of copper for mesoscale materials science of ductile damage in four dimensions. 2014. In *2014 World Congress on Powder Metallurgy & Particulate Materials (PM 2014)*. (Orlando, FL, 18-22 May 2014). , p. 0946. Orlando, FL: APMI International.
- Landecker, W., R. Chartrand, and S. DeDeo. Robust sparse coding and compressed sensing with the difference Map. 2014. In *European Conference on Computer Vision*. (Zurich, 6-12 September, 2014). Vol. 8691, p. 315. Zurich: Springer International Publishing Switzerland.
- Lebensohn, R. A., J. P. Escobedo, E. K. Cerreta, Dennis-Koller, C. A. Bronkhorst, and J. F. Bingert. Modeling void growth in polycrystalline materials. 2013. *Acta Materialia*. 61 (18): 6918.
- Lebensohn, R. A., and R. Pokharel. Interpretation of microstructural effects on porosity evolution using a combined dilatational/crystal plasticity computational approach. 2014. *Journal of the Minerals, Metals and Materials Society (JOM)*. 66 (3): 437.
- Lieberman, E., A. D. Rollett, R. A. Lebensohn, and E. M. Kober. Calculation of grain boundary normals directly from 3-D microstructural images. *Modelling and Simulation in Materials Science and Engineering*.
- Pokharel, R., J. Lind, A. K. Kanjarla, R. A. Lebensohn, S. F. Li, Kenesei, R. M. Suter, and A. D. Rollett. Polycrystal Plasticity: Comparison Between Grain-Scale Observations of Deformation and Simulations. 2014. *Annual Review of Condensed Matter Physics*. 5: 317.
- Pokharel, R., J. Lind, S. F. Li, P. Kenesei, R. A. Lebensohn, R. M. Suter, and A. D. Rollett. In-situ observation of bulk 3-D microstructure evolution of polycrystalline copper using synchrotron radiation. To appear in *International Journal of Plasticity*.
- Rovinelli, A., R. A. Lebensohn, and M. D. Sangid. Influence of microstructure variability on short crack growth behavior. *Engineering Fracture Mechanics*.
- Sidky, E. Y., R. Chartrand, J. M. Boone , and X. Pan. Constrained TpV minimization for enhanced exploitation of gradient sparsity: application to CT image reconstruction. 2014. *IEEE Journal of Translational Engineering in Health and Medicine*. 2: 1.
- Stein, C. A., A. Cerrone, T. Ozturk, S. Lee, P. Kenesei, H. Tucker, R. Pokharel, J. Lind, C. Hefferan, R. M. Suter, A. R. Ingraffea, and A. D. Rollett. Fatigue crack initiation, slip localization and twin boundaries in a nickel-based superalloy. 2014. *Current Opinion in Solid State and Materials Science*. 18 (4): 244.
- Subedi, S., R. Pokharel, and A. D. Rollett. Orientation gradients in relation to grain boundaries at varying strain level and spatial resolution. *Materials Science and Engineering A*.

Optimization and Control of Dynamic Networks

Robert E. Ecke
20140565DR

Introduction

Network science research has been primarily focused on the simplification of dynamic graphs to static graphs and their topological characteristics. But processes on networks such as the spread of a virus on a social network, traversal through a cyber network, and cascading failures in a power grid are critically dependent on the dynamic nature of the underlying network.

These dynamic graphs are at the heart of technological and scientific problems in electrical power grids. Deployment of new technologies, such as renewable generation and electric vehicles, is rapidly transforming electrical power networks by coupling previously distinct spatiotemporal scales and challenging traditional approaches for designing, analyzing, and operating power grids. The interactions of spatiotemporal scales in power systems are pushing the limits power engineering best practices and we need to develop general complex system models at the appropriate level of network detail necessary to isolate and analyze the relevant static, dynamic, and stochastic phenomena.

Computer networks are also inherently dynamic and non-stationary. Capturing the dynamics of user activity through coarse-level and high-fidelity modeling is critical to understanding normal activity and detection of anomalous activity. Only recently has a network-wide (graph theory) viewpoint been taken.

The CNLS brings a unique perspective in the integration of interdisciplinary approaches and ideas to the subject of network science. The CNLS has been a leader and innovator in Information Science and Technology. In particular the CNLS has helped provide new approaches in theory and modeling of networks for more than 10 years. The CNLS has helped nucleate efforts at LANL for applications of networks in neurocomputation, smart grid, and cybersecurity.

Benefit to National Security Missions

Information Science and Technology is a Laboratory strategic pillar that touches a broad spectrum of science at LANL from discovery science to pivotal program needs. This proposal directly addresses Complex Networks capabilities through the modeling of dynamic networks and with applications to cybersecurity and power systems ("smart grids").

This proposal develops core information science and technology capabilities needed to address the open questions of the Office of Electricity that intersect with the scientific goals of DOE's Office of Advanced Scientific Computing Research (ASCR) Applied Mathematics Program such as uncertainty quantification in complex engineered networks.

This project will innovate with basic research supporting LANL's internal cybersecurity programs and Global Security programs. Effective cyber defense of the weapons complex is essential to its security and effectiveness.

Progress

We studied random intersection graphs which are random bipartite graphs projected onto one set of the bi-partition. Such graphs capture the bipartite nature of many real world networks, such as some cyber networks, and social networks. Notably, they allow the description of sparse random graphs with tunable clustering, while at the same time are mathematically tractable. Recent work in network science has explored the "tree-like" properties - such as hyperbolic geometry, k -core decomposition, and tree decomposition - of real world networks. We proved that the simplest model of random intersection graphs has unbounded hyperbolicity in the sense of Gromov.

We published the article by Garcia, Giani, Poolla "Partial state estimation for electricity grids," as part of the Decision and Control (CDC), 2013 IEEE 52nd Annual

Conference. Power system operators rely critically on state estimation for verification, fault detection and localization, and re-dispatch under contingency operations. In current practice, power system data within a control area such as voltages, phases, real and reactive power flows and injections, are relayed to the operator using SCADA systems. We formulated the problem as an over-determined weighted nonlinear least squares problem and used the formulation to explore techniques to accelerate state estimation. Our techniques, inspired by uncertainty quantification methods, compute state estimates at a small subset of buses using limited measurements from the power subsystem of interest.

We developed algorithms for placement of phasor measurement units to prevent unobservable attacks. This work was presented in the lecture “Phasor Measurement Unit Placement for Unobservable Attack Detection” at the International Conference on Critical Infrastructure.

Using a partial differential equation model for the electrical load flow, we have analyzed the induction motor dynamics in a distribution feeder under the effect of a fault/disturbance. We have found that the steady state behavior of the rather complex dynamics of inductor motor stalling in a distribution feeder can be predicted with reasonable accuracy at the end of a fault. This result could be used to accurately estimate the critical fault clearing time to avoid instability. This work was presented in a poster titled “Critical Clearing Times and Simplified Models for Fault-Induced Delayed Voltage Recovery”.

Future Work

For FY15 we will seek the following goals:

- Create comprehensive ODE/PDE models for power systems that incorporate the different devices and controls that are making inroads into electrical distribution networks, e.g., PV systems, electric vehicle charging, and frequency responsive loads. The ODE/PDEs approach will address the interaction of emergent phenomena arising from the interaction of new smart-grid components.
- Develop reduced-order stochastic models of the short-term dynamics that are key to understanding power outage cascades. We will develop new approximate statistical methods to capture underlying interactions and scale separations and seek effective parallel control algorithms to mitigate cascades.

We will model cybersecurity systems as dynamic networks and seek to incorporate rich-data such as time-series of observations of authentication, web-surfing, or file-

sharing. We will develop techniques including hierarchical models to handle the statistics of the bursty network communication patterns commonly observed.

Conclusion

We expect the following results:

Dynamic Networks: develop models and algorithms for temporal random graphs; seek theorems for connectivity and reachability in the models; and explore the range of possible temporal correlation patterns.

Power Systems: create comprehensive ODE/PDE models for power systems; develop reduced-order stochastic models of network power-outage cascades; develop mathematical tools to capture system energy and thermal states.

Cybersecurity: model as dynamic networks; develop techniques including hierarchical models to capture statistics of bursty network communication patterns; create inference methods and fit cyber authentication network data to the temporal random graph models.

Publications

- Farrell, M., T. Goodrich, N. Lemons, F. Reidle, F. Villaamil, and B. Sullivan. Hyperbolicity, degeneracy, and expansion of random intersection graphs. 2014. arXiv.
- Generous, N., G. Fairchild, A. Deshpande, S. Y. Del Valle, and R. Priedhorsky. Global disease monitoring and forecasting with Wikipedia. . 2014. arXiv.
- Kundu, S., and I. A. Hiskens. Overvoltages due to Synchronous Tripping of Plug-in Electric-Vehicle Chargers Following Voltage Dips. 2014. IEEE Transactions on Power Delivery. 29 (3): 1147.
- Kundu, S., and I. Hiskens. Nonlinear dynamics of hysteresis-based load controls. To appear in The 19th World Congress of the International Federation of Automatic Control. (Cape Town, South Africa, 24-29 Aug. 2014).
- Tapia, A., N. LaLone, E. MacDonald, R. Priedhorsky, and M. Hall. Crowdsourcing rare events: Using curiosity to draw participants into science and early warning systems. . To appear in International Conference on Information Systems for Crisis Response and Management (ISCRAM), 2014. (University Park, Pennsylvania, 18-21 May, 2014).
- Turcotte, M.. Detecting localised anomalous behaviour in a computer network . To appear in Advances in Intelligent Data Analysis XIII, LNCS 8819 . (Leuven, Belgium, 30 Oct - 1 Nov, 2014).
- Yamangil, E., R. Bent, and S. Backhaus. Designing Resilient Electrical Distribution Grids. 2014. arXiv:1409.

Energy Storage

Rangachary Mukundan
20120003DR

Abstract

Energy storage technology is critical if the U.S. is to achieve more than 25% penetration of renewable electrical energy, given the intermittency of wind and solar. Energy density is a critical parameter in the economic viability of any energy storage system with liquid fuels being 10 to 100 times better than batteries. However, the economical conversion of electricity to fuel still presents significant technical challenges. This project addressed these challenges by focusing on a specific approach: efficient processes to convert electricity, water and nitrogen to ammonia. Ammonia has many attributes that make it the ideal energy storage compound. The feedstocks are plentiful, ammonia is easily liquefied and routinely stored in large volumes in cheap containers, and it has exceptional energy density for grid-scale electrical energy storage. Ammonia can be oxidized efficiently in fuel cells or advanced Carnot cycle engines yielding water and nitrogen as end products. Because of the high energy density and low reactivity of ammonia, the capital cost for grid storage will be lower than any other storage application. This project developed the theoretical foundations of N₂ catalysis on specific catalysts and provided for the first time experimental evidence for activation of Mo₂N based catalysts. Theory also revealed that the N atom adsorbed in the bridging position between two metal atoms is the critical step for catalysis. Simple electrochemical ammonia production reactors were designed and built in this project using two novel electrolyte systems. The first one demonstrated the use of ionic liquid electrolytes at room temperature and the second the use of pyrophosphate-based electrolytes at intermediate temperatures (200 – 300 oC). The mechanism of high proton conduction in the pyrophosphate materials was found to be associated with a poly-phosphate second phase contrary to literature claims and ammonia production rates as high as 5X10⁻⁹ mol/s/cm² were achieved.

Background and Research Objectives

The storage of energy from intermittent renewable energy sources to supply the irreducible base needed by electrical utilities is a critical limitation to widespread use of renewable energy. Ammonia has been proposed by many as a carbon-free energy carrier and storage medium (NH₃ holds 14 MJ/liter, 10-100 times more than the best battery). However, current methods of ammonia production have high capital costs, low to moderate efficiency, and are not scalable to utility levels. Our main goals are to: 1) Improve our theoretical understanding of nitrogen reduction on surfaces, multielectron transfer to adsorbed molecules, and proton transport in anhydrous electrolytes; 2) Develop, characterize and optimize new materials for electrolytes and electrocatalysts for ammonia electrosynthesis; and 3) Demonstrate improved efficiency of scalable ammonia electrosynthesis concepts.

Scientific Approach and Accomplishments

The development of suitable catalysts for NH₃ production involved a combined theoretical/experimental effort to identify critical steps in the dissociation of N₂ on potential catalyst surfaces. In addition, two approaches to electrochemical ammonia synthesis were considered in this project. The first involved the use of ionic liquids that hold the promise of high NH₃ production rates at room temperature and the other involved the use of intermediate temperature proton conductors that have the advantage of greater NH₃ production rate through improved kinetics

Catalyst development

The primary focus of the catalyst development work undertaken in this project was in the improved understanding of the structure-activity relationship for the heterogeneous ammonia production catalyst γ -Mo₂N. An experimental Diffuse Reflectance FTIR (DRIFTS) capability was developed early on in the project and was implemented on a recently purchased FTIR system. Using this new capability, we were able to study the behavior

of the catalysts at the solid-gas interface, generating first in-situ measurements of the catalyst activation, H₂ and N₂ gas adsorption and catalytic conversion. Previous works of Boudart and others have shown that for the γ -Mo₂N to be catalytically active towards H₂ and N₂ to ammonia conversion, it has to be activated under hydrogen at temperatures >300 °C [1]. It is generally assumed that the activation involves reduction of oxidized molybdenum nitride, in the form Mo_xN_yO_z, to its active form, γ -Mo₂N. However, the activation process is poorly understood. We were, for the first time, able to study the activation process in-situ by DRIFTS. Specifically, we identified vibrational modes associated with Mo-O stretching vibrations (at 953 cm⁻¹) in Mo_xN_yO_z and showed that their disappearance under reducing conditions can be monitored in real time (Figure 1). By monitoring the Mo-O vibrational mode under systematically varied reducing conditions we discovered the catalyst activation time can be significantly reduced (1-2 hrs) compared to what was previously considered necessary (12-24 hrs). With better understanding of the activation process (and its reversibility) we further studied the adsorption of the N₂ and H₂ gases as a function of pressure and temperature on activated and passivated surfaces. For the first time, we detected vibrational signatures of N₂ adsorbed on the active γ -Mo₂N surface (and provided direct evidence that adsorption does not take place on passive surface under the same conditions). Several vibrational modes consistent with the Mo-N-N configuration were detected as well evidence for formation of Mo-N species.

The observed vibrational frequencies were consistent with the results of our DFT calculations. The DFT calculations focused on the mechanism of conversion of molecular hydrogen and nitrogen on a molybdenum nitride catalyst surface. The thermodynamics of the adsorption and conversion to molecular nitrogen were calculated and it was determined that both the associative and dissociative mechanisms should be competitive under reaction conditions. The vibrational spectra of intermediate molecular species adsorbed on the catalyst surface were also calculated in order to predict spectroscopic signatures of each reaction pathway. The frequencies were compared to results from both inelastic neutron scattering measurements and diffusion reflectance infra-red spectroscopy in order to rationalize experimental data. An assessment of the performance of several different density functions for prediction of vibrational frequencies was also carried out. On all the studied surfaces of Mo₂N a N₂ molecule can adsorb on top of a Mo atom in a Mo-N-N configuration where the axis of N₂ molecule is perpendicular to the metal surface. We were able to assign all the frequencies observed in the IR spectrum to specific surface vibrations. Vibrations below

1000 cm⁻¹ correspond to the atomic species adsorbed on Mo₂N indicating that nitrogen molecule can dissociate on Mo₂N surface. Namely, when compared to the DFT calculated frequencies, the peak observed at 939 cm⁻¹ can be assigned to Mo-N stretching of the N atom adsorbed on top of Mo atom, while a peak observed at 802 cm⁻¹ can be assigned to the corresponding mode of the N atom adsorbed in the bridging position between two Mo atoms. This covalent bonding geometry is found to promote bond-mediated delocalized electronic states in the catalyst, which facilitate the protonation of the apical dinitrogen ligands. This process allows the catalyst to function more efficiently in the dimeric form than as a monometallic fragment. Theoretical studies also confirmed that this step was key to the activity of previously published homogeneous catalyst (Nishibayashi organometallic catalysts) [2].

The work on homogeneous catalysis was concerned with an investigation of the mechanism of conversion of the reduction of molecular nitrogen to ammonia using the Nishibayashi organometallic catalyst. A key intermediate in the proposed mechanism is a dimolybdenum dinitrogen complex, in which the nitrogen molecule bridges the two metal centers.

Ionic liquids

The high-pressure experimental research capability of the Laboratory was enhanced by the completion of a high-pressure reaction chemistry facility. The facility, located in MPA-Division, includes a custom designed high-pressure system (200 atm) to perform gas adsorption, infrared spectroscopy of surfaces and high-pressure electrochemical experimentation. The laboratory now can safely perform ammonia synthesis, characterize ammonia adsorption in non-aqueous electrolytes, determine the reaction species and intermediates on electrochemical catalyst surfaces and measure fundamental thermodynamic properties of ionic liquid electrolyte ammonia mixtures.

This high-pressure system was equipped with a one-compartment electrochemical cell that has been used to measure the ammonia absorption isotherms at different temperatures as well as to perform the electrochemical characterization of the ionic liquid and ammonia solutions using standard DC techniques as well as Electrochemical Impedance Spectroscopy (EIS). The electrochemical cell was furnished with a Teflon liner, magnetic stir bar and capped with a custom made vacuum/pressure tight head equipped with six electrical connectors allowing the use of a standard three electrode setup including two single working electrodes, a counter electrode and a reference electrode as well as an independent conductivity probe.

The ammonia absorption isotherms and the in-situ electro-

chemical characterization were carried out at 25 oC, 35 oC, 50 oC, and 75 oC. The thermodynamic results showed a linear relationship between the NH₃ partial pressure in the gas phase and the NH₃ molar fraction in the ionic liquid with a slope (Henry's constant) that increases with temperature. From the temperature dependence of Henry's constant, a $\Delta H_{\text{solv}} = -14.8 \text{ KJ.mol}^{-1}$ was calculated. This result is especially important for the electro-synthesis of ammonia in the ionic liquid since conductivity will play a key role determining the viability of the electrochemical process. Additionally, the electrochemical characterization carried out using AC Impedance measurements showed an increase in conductivity with temperature and with the molar fraction of ammonia in the ionic liquid. Also important are the results showing a decrease for the charge transfer resistance as the ammonia molar fraction in the ionic liquid increases. This parameter is directly related to the ammonia electrochemical oxidation that can occur as a side reaction at the anode during the electro-synthesis. This reaction would negatively affect the efficiency of the ammonia production. Therefore, it will be necessary to use a two-compartment electrochemical cell during the electro-synthesis to avoid the undesired diffusion of the produced ammonia towards the anode. Although a significant effort has been made to develop an electrochemical method using ionic liquids to convert gaseous nitrogen to ammonia, the attempts to electro-catalytically reduce nitrogen to ammonia at low temperatures and pressures have not been very successful. Therefore, intermediate temperatures were pursued to further improve the rate of NH₃ generation.

Intermediate temperature proton conductors

New indium tin pyrophosphate and strontium cerate proton-conducting membranes were synthesized and characterized. The proton conduction mechanism of tin pyrophosphate is currently under debate within the scientific community. Previous papers indicated that the conductivity mechanism of the pyrophosphates is very similar to those of the high temperature perovskites where the protons hop between the various oxygen sites in the crystal structure [3]. DFT calculations performed on the intermediate temperature proton conducting material revealed that the proposed structure in the literature featuring a 180 degree P-O-P angle was found to be less stable than structural models having smaller angles, and this was particularly noticeable when proton were bound to the bridging oxygen. The proton-hopping pathway was calculated in the stoichiometric phase as well as several defective structural models, but in each case, the activation barrier was found to be similar to values expected for high-temperature ceramic membranes. Therefore this bulk diffusion mechanism was unable to account for the

anomalously high conductivity observed experimentally. Further calculations on grain boundary models for the pyrophosphate structure containing free phosphoric acid molecular species give support for a proton conductivity mechanism based on these structural elements.

A large number of indium tin pyrophosphate materials with varying metal to phosphate ratios were synthesized using solution precipitation methods developed and patented by LANL. The crystal structures, surface areas and ionic conductivities as a function of temperature, and gas composition were determined by electrochemical transport measurements. Our data clearly showed that no structural changes in the crystalline phase were occurring as the sample composition was varied from stoichiometric to excess phosphate compositions. Both X-ray fluorescence (XRF) and Thermo-gravimetric (TGA) analysis were used to quantify the amount of this second phase and excellent correlation was obtained between sample conductivity and amount of second phase. Neutron vibrational spectroscopy (NVS) and FTIR were performed to characterize the protons associated with this second phase and indicated that a poly-phosphate type material, probably at the grain boundaries was responsible for the high proton conductivity observed in these materials. High-resolution neutron powder diffraction provided further insight into the nature of proton incorporation in the crystalline phase responsible for only moderate conductivity at elevated temperatures (>600°C) and several publications resulted from this LDRD-DR that have finally resolved the conduction mechanism in this interesting class of materials.

Electrochemical ammonia production was demonstrated using both high temperature perovskite and intermediate temperature pyrophosphate electrolytes. Ammonia production rates as high as 5×10^{-9} moles/cm²/sec were obtained which are very comparable to the best ever reported rates in the literature (1×10^{-8} moles/cm²/sec) that use significantly more complicated electrochemical systems to achieve these rates [4]. Optimization of the catalysts and improvement of current efficiency of these pyrophosphate based electrochemical systems hold the promise of further increases in electrochemical NH₃ production rate and efficiency. The materials developed in this project are also currently being studied as electrolytes for intermediate temperature fuel cells. This new project funded by ARPA-E was an off-shoot of the LDRD-DR and illustrates that novel materials developed in specific for NH₃ synthesis can have significant impact in other areas of electrochemistry including fuel cells.

Impact on National Missions

LANL has a stated mission in the area of Energy Security.

This project of coupled experiment and theory supports directly the LANL grand challenges in Energy and Earth Systems and Materials; coupling to the themes of energy storage, interfaces, emergent properties, and nanotechnology. This project has helped establish LANL as the premier laboratory in the US for work on novel intermediate temperature proton conducting electrolytes. This leadership role has led to the subsequent award of an ARPA-E project that utilizes these materials for fuel cell application. In addition to the new electrolytes developed, this project has also established capabilities in the area of N₂ catalysis, and high-pressure measurements of NH₃ solubility and conductivity in ionic liquids and other solvents. This capability is expected to lead to follow-on proposals in BES in the areas of new materials, interfaces, emergent properties, energy conversion, and energy storage. In the applied area, such as ARPA-E, DOE-EERE, and DOE-OE, this work will position LANL to lead or be a strong team member with ANL for the development of improved transportation, local, and distributed-grid-level electrical storage systems. The low cost synthesis of ammonia from renewable energy is also of importance to the USDA.

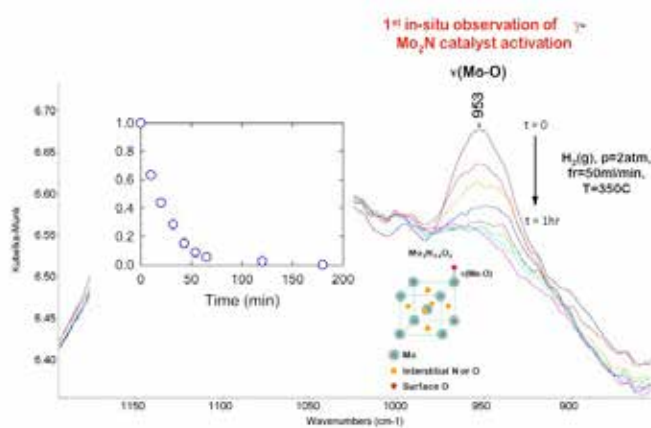

Figure 1. DRIFTS spectrum of the surface of passivated MoNO (MoNO) under reducing conditions (H). The variation in the intensity of the vibrational mode at 953 cm associated with the Mo-O stretching vibration, provides a first in-situ real time observation of the MoN catalyst. The inset shows the decrease in intensity as a function of activation time in H gas at 250C.

References

- Volpe, L., and M. Boudart. Compounds of molybdenum and tungsten with high specific surface area: I. Nitrides. 1985. Journal of Solid State Chemistry. 59 (3): 332.
 - Arashiba, K., Y. Miyake, and Y. Nishibayashi. A molybdenum complex bearing PNP-type pincer ligands leads to the catalytic reduction of dinitrogen into ammonia. 2011. Nature Chemistry. 3: 120.
 - Nagao, M., T. Kamiya, P. Heo, A. Tomita, T. Hibino, and M. Sano. Proton conduction in In₃₊ doped SnP₂O₇ at intermediate temperatures. 2006. Journal of the Electrochemical Society. 153 (8): A1604.
 - Licht, S., B. Cui, B. Wang, F. F Li, J. Lau, and S. Liu. Ammonia synthesis and N₂ and steam electrolysis in molten hydroxide suspensions of nanoscale Fe₂O₃. 2014. Science. 345: 647.
- ## Publications
- Garzon, F. H., C. R. Kreller, M. S. Wilson, R. Mukundan, H. Pham, N. Henson, M. Hartl, and L. Daemen. Proton Conduction in Inorganic Phosphates. ECS Transactions 61 (2014), 159-168. 2014. ECS Transactions. 61: 159.
- Kreller, C. R., F. H. Garzon, M. S. Wilson, R. Mukundan, H. Pham, N. Henson, M. Sykora, M. Hartl, and L. Daemen. Proton Conduction in Crystalline Sn_{1-x}In_xP₂O₇ (x=0 and 0.1). The Journal of the American Chemical Society.
- Kreller, C. R., M. S. Wilson, R. Mukundan, E. L. Brosha, and F. H. Garzon. Stability and Conductivity of In₃₊-Doped SnP₂O₇ with Varying Phosphorous to Metal Ratios. 2013. ECS ELECTROCHEMISTRY LETTERS. 2 (9): F61.
- Kreller, C. R., M. S. Wilson, and F. H. Garzon. Enhancing the Protonic Conductivity of Tin Pyrophosphates by Increasing Phosphate Content. 2013. Electrochemical Society Transactions. 57 (11): 1009.
- Matanovic, I., F. H. Garzon, and N. J. Henson. Electro-reduction of nitrogen on molybdenum nitride: structure, energetics, and vibrational spectra from DFT. 2014. Physical Chemistry Chemical Physics. 16 (7): 3014.
- Matanovic, I., P. Atanassov, B. Kiefer, F. H. Garzon, and N. J. Henson. Applicability of density functional theory in reproducing accurate vibrational spectra of surface bound species. 2014. Journal of Computational Chemistry. 35 (26): 1921.
- Ogumi, Z., H. Matsuoka, F. Garzon, H. Kim, L. J. Wan, K. Tamao, and M. Nakamura. Electrochemistry 80th Anniversary Special Issue. 2013. ELECTROCHEMISTRY. 81 (3): 140.
- Sansinena, J. M., J. Chilstunoff, N. C. Tomson, J. M. Boncella, and F. H. Garzon. Ionic Liquids for Ammonia Electrosynthesis and Energy Storage. Presented at 224th Meeting of the Electrochemical Society. (San Francisco, 27 Oct- 4 Nov. 2013).
- Sansiñena, J. M., J. B. Chilstunoff, N. C. Tomson, J. M. Boncella, and F. H. Garzón. Thermodynamics of Absorption and Electrochemical Characterization of Binary Mixtures of Ammonia and Butylmethylpyrrolidinium

Triflamide Ionic liquid. *Journal of Physical Chemistry B*.

Tian, Y. H., A. W. Pierpont, and E. R. Batista. How Does Nishibayashi's Molybdenum Complex Catalyze Dinitrogen Reduction to Ammonia?. 2014. *Inorganic Chemistry*. 53: 4177.

Organic Electronic Materials: Designing and Creating Functional Interfaces

Sergei Tretiak
20120019DR

Abstract

The description of disordered organic materials and the interfaces between these materials presents an exciting challenge that requires the establishment of new approaches lying between those of condensed matter (which typically relies on crystal periodicity) and molecular chemistry (which typically relies on small system size). In this project, we have developed new theoretical tools and mastered sophisticated experimental techniques, which together enable a quantitative jump in our understanding of physical and dynamical processes in disordered organic electronic materials. By manipulating both the nanostructure of the molecular building blocks and the structure of the interfaces between them through synthetic and fabrication processes, we have engineered materials and fabricated devices with emergent properties and unprecedented efficiencies. Our interdisciplinary research has broadly utilized the group's unique depth of expertise in theory (spanning all length scales from molecular electronic structure simulations to mesoscale device modeling), time- and spatially resolved spectroscopic and transport measurements, organic synthesis, device fabrication and characterization.

Background and Research Objectives

Recent Nobel Prizes in Chemistry (2000, conducting polymers) and in Physics (2010, graphene) have highlighted key breakthroughs in the development of organic electronic materials. These materials have attractive electronic properties and low production costs that give them the potential to revolutionize electronic, photovoltaic, display, sensing, and lighting technologies. Over the past decade the first phase of organic electronics commercialization took place. For example, more than 2 million organic LED (light-emitting diode) displays are now produced each month, with new organic-based lighting panels, thin film transistor circuits, solar cells, and chemical sensors becoming commercially available every year. Despite this significant technological progress, the field of organic electronics stands at a critical

junction and faces a situation similar to the early days of inorganic semiconductors when basic material and device principles were recognized but before the ability to design complex structures such as heterojunction diode lasers and integrated circuits. To date, the "design" of functional organic interfaces has mostly relied on 'trial and error' approaches driven by advances in synthetic and fabrication techniques. Thus, there is a critical need for research addressing the underlying physical design principles and development of conceptual predictive framework if we are to efficiently utilize the power of organic synthesis and realize the benefits of organic electronic devices. Analogous to the early development of inorganic semiconductor devices, the next generation of organic semiconductor devices increasingly relies on the properties of material interfaces, both organic/organic and organic/inorganic. For example, organic/organic interfaces are the critical element in organic solar cells (they enable exciton dissociation and charge separation which determines high solar energy conversion efficiency) and organic/inorganic interfaces (e.g., silicon-oxide/pentacene) determine the performance of organic field effect transistors. The electronic states at these interfaces are both critical to performance and poorly understood. Thus the present-day inability to engineer and control the functionality of various interfaces in these 'soft' materials is a key bottleneck on the path toward the next generation of organic electronic devices.

Our project has addressed this challenge via a closely coupled theory-experiment-synthesis effort at LANL aimed at modeling, probing and controlling the charge (polaron) and exciton electronic energy landscape and dynamics in organic electronic materials and devices. In this work, theory guided and simultaneously benefitted from experimental efforts that utilized a broad range of powerful spectroscopic probes to obtain detailed information on exciton, electron and hole dynamics. Theory-guided material synthesis was built on unique synthetic LANL capabilities recently developed for the

fabrication of novel organic device architectures based on self-assembled and patterned heterojunctions. Target materials included thin films with controlled morphologies prepared from functionalized small molecules and polymers. A central theme of this project was to understand how the distribution of molecular conformations at organic semiconductor interfaces influences the critical electrical processes of interfacial charge and energy transport. The molecules that make up organic semiconductors are often flexible, and have many molecular conformations with nearly the same energy. The electronic structure of an organic semiconductor depends strongly on the distribution of molecular conformations. Intermolecular interactions are a very important feature determining the distribution of these molecular conformations. Intermolecular interactions at organic interfaces can be very different from those in the bulk, and thus the distribution of molecular conformations at organic semiconductor interfaces is expected to be distinct from those in bulk organic semiconductors.

We have worked in three distinct research directions that attacked the most critical problems in designing and creating functional interfaces in organic materials. We have investigated i) how packing materials with different molecular structures influences the distribution of molecular conformations near the interface, ii) how these distributions define the interface electronic structure, and iii) how the interface electronic structure controls interfacial charge and energy transport, and ultimately relates to device performances.

Scientific Approach and Accomplishments

Our effort focus on the fundamental and applied science of organic π -conjugated materials including films and blends of conducting polymers and small molecules, all of technological importance, present-day or anticipated. The innovative concept motivating this proposal is the idea that there are general physical principles describing organic electronic materials that can be used to guide material and device design. Our goal was to discover these physical principles and to expose them to the organic electronic materials community. Discovering these principles requires demonstrating them in molecular, thin film, and device contexts. To do so it is critical to get insights into important physical phenomena at multiple lengthscales from molecule to nanodomains to phase-separated mesoscales with integrated theoretical and experimental techniques. Subsequently, development of new capabilities was paramount to our research. We have developed novel theoretical modeling tools spanning multiple time and length timescales, able to guide experimental studies. We significantly extended our LANL-developed Non-Adiabatic Excited State Dynamics (NA-ESMD) code (as reviewed in our prestigious Account

on Chemical Research article) toward a computational platform to simulate the electronic (e.g., photoexcitation) and vibrational dynamics of large organic molecules within a complex environment. Several theoretical challenges were overcome, such as taking into account quantum interference effects (a 20 year-old-problem that we resolved in a high profile Nature Communication article) and algorithms dealing with trivial crossing problems. Using the NA-ESMD tools we have successfully investigated energy transfer processes in several prototypical light-harvesting dendritic systems and conformational dynamics in several conjugated polymers (Figure 1). Our theoretical study confirmed experimental data and explained mechanisms leading to excited-state-specific ultrafast relaxation, introducing concepts of 'quantum kick' and 'quantum brake' in the conformational space, which have changed our understanding on how fast a single photon can alter the molecular shape, and have important implications for organic light-emitting technology (highlighted in Nature Physics). On the larger scale, we have developed multiscale macroscopic charge transport models, 'bridging the gap' between local properties of the polaron and exciton (nanoscale) and mesoscopic charge mobilities and exciton (micron-scale). These methodologies are summarized in our invited review (Annual Review of Physical Chemistry) and were applied to multiple systems of interest. Finally, on the device-scale to evaluate the influence of interfaces on the device performance, new physics-based models were applied to get important insights into experimental data.

Our synthetic efforts focused on a series of thiophene oligomer derivatives: terthiophene, quatertiophene and pentathiophene derivatives with a thiolated end group that allows covalent bonding to the Au/Ag substrate surfaces. These oligothiophenes have been fully characterized with a suite of organic spectroscopies and quantum chemistry to determine their molecular structures and functionality. We have also constructed a series of self-assembled monolayer (SAM) thin films on single crystalline gold surfaces and characterized the structure and optical properties of these SAM samples using Scanning Tunneling Microscope (STM) and optical spectroscopies (Figure 2). These studies revealed a surprising fact that only certain oligomers from the family are able to organize into ordered monolayers; the rest form globular structures (Figure 3). These properties make clear differences on the device performance (as described below) due to changing the underlying interface structure, as rationalized by quantum-chemical simulations. Our device fabrication and spectroscopic efforts focused on four fundamental processes that determine the performance of typical organic photovoltaic devices. Typically exciton dissociation rate is faster than it needs to be by several orders of magnitude, and charge

transfer state recombination is also too fast. We have inserted a LiF insulating layer between the donor and acceptor layer in a prototypical system (tetracene(Tc)/fullerene bi-layer) and find that there is an optimum thickness of the insulator layer for improving device performance. Ultra-fast pump-probe spectroscopy study was further able to follow the dynamics of singlet and triplet excitons induced by ultrashort laser pulse absorption in thin Tc/fullerene films. These studies reveal a complex dynamics of multiple excited states and present a first spectroscopic evidence of timescales and pathways related to the exciplex formation in this system. Spectroscopic studies in the presence of magnetic field brought unique information on emission dependence on the applied magnetic field evidencing impact of hyperfine interactions in the dynamics of spin states (Figure 4). Concurrent electronic structure studies and device modeling interpreted the underlying phenomena in terms of ‘hot’ and ‘cold’ exciplex states.

Our further experimental/theoretical study of the effect of ordering and insulation layer spacers at the interfaces led to novel interface design principles for high efficiency organic semiconductor devices. Specifically, we learned how precise manipulation and control of organic-organic interfaces using innovative interface modification strategies can overcome a long standing bottleneck of interface recombination in organic photovoltaic devices (Figure 5). These lead to a dramatic increase in its power conversion efficiency by 2-5 times in a model bilayer system, and from 4.0% to almost 8.0% when these design principles are applied to practical architectures like bulk heterojunctions. These interface design strategies are universally applicable to any donor-acceptor interface, making them both fundamentally interesting and technologically relevant for achieving high efficiency organic electronic devices. Our manuscript on this result has been submitted to Nature Materials. Finally we combined the several lessons that we have learned, and applied them to novel solution-processed hybrid organic-inorganic perovskite materials holding high promises for photovoltaic technologies. This led to discovery of large area (mm-scale) growth of single crystalline, hybrid perovskites using an innovative solution-based “hot casting slow quenching” technique. We demonstrate record-breaking light to electricity conversion efficiencies approaching 18% in perovskite solar cells with planar geometries. This strategy is expected to lead to more efficient photovoltaics that approach theoretically predicted limits (an article currently undergoing review in Nature Materials). An application for a patent for a discovered technology was filed.

In summary our project focused on engineering functional interfaces in organic electronic materials resulted in

multiple scientific findings and discoveries as reflected in about 50 publications in peer-reviewed journals (including the most prestigious publishers), a novel modeling toolbox, and a potential patent.

Impact on National Missions

The project objectives has been achieved through integration of LANL strengths in theory, spectroscopy, chemistry, high-performance computing, and materials science on multiple length- and time-scales, thereby realizing the vision of “co-design” and coupling theory, experiment, and simulation tools. The outcome will position the Lab for mission contributions in the strategic field of Organic Functional Materials, with application to a range of sensing missions. We primarily addressed the Materials: Discovery Science to Strategic Applications challenge by (i) a thorough understanding of dynamical processes at interfaces, (ii) their application to control of the material functionality and (iii) by discovering emergent phenomena in complex systems. The project also strongly supported energy and Earth systems mission needs by providing design strategies for molecular materials suitable for clean energy production. This had a direct and significant impact on Laboratory missions in (i) alternative and clean Energy, (ii) biosensing and chemical sensing and (iii) nanotechnology including spintronics.

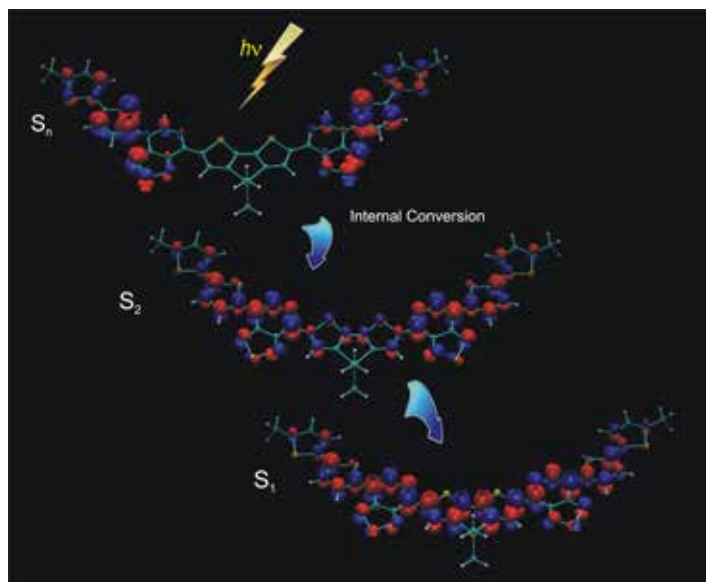

Figure 1. Simulated photo-excited molecular dynamics in a conjugated molecule (*p*-DTS(PTTh₂)₂) showing high promise for organic solar cells. Orbital plots show calculated time-dependent evolution of the electronic wave-function illustrating non-radiative excited state relaxation involving multiple electronic states.

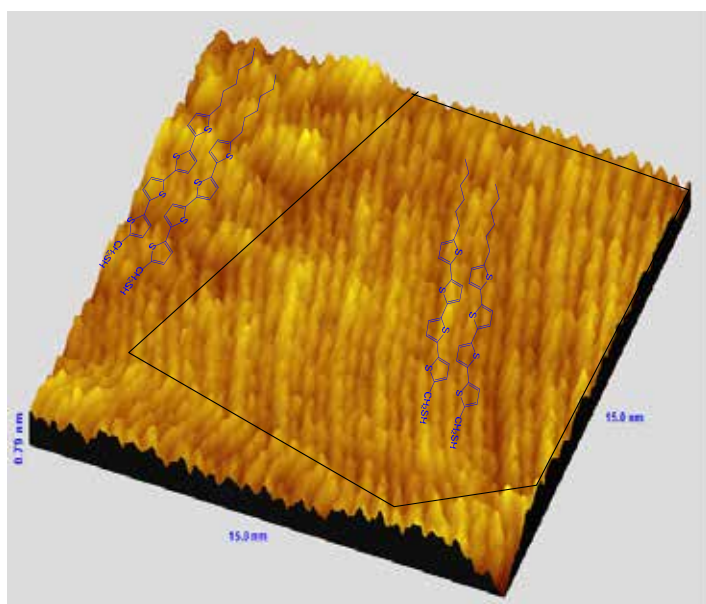

Figure 2. Scanning Tunneling Microscope (STM) image of thiolated terthiophene molecules self-assembled on top of a single crystalline gold (Au) substrate.

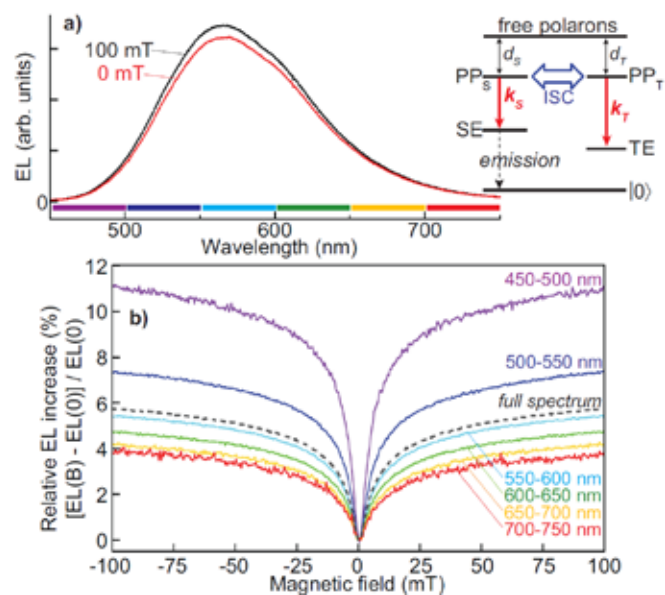

Figure 4. Electroluminescence (EL) spectra at $B=0$ and 100 mT. Inset: Exciplex formation model. Weakly-bound singlet and triplet polaron pairs (PP) form from free carriers. PPS-PPT mixing (intersystem crossing; ISC) exists at $B=0$ due to hyperfine coupling to randomly-oriented nuclear spins. Singlet and triplet exciplexes (SE, TE) subsequently form with rates k_S , k_T . Only SE recombines radiatively. (b) The relative EL intensity versus B , integrated and normalized over the wavelengths indicated. At blue wavelengths, the EL boost is larger (indicating larger k_T/k_S ratio), and the curves are narrower (indicating weaker hyperfine coupling, due to the larger spatial extent of the polarons at these energies). The dashed line indicates the B dependence of the total (spectrally-integrated) EL.

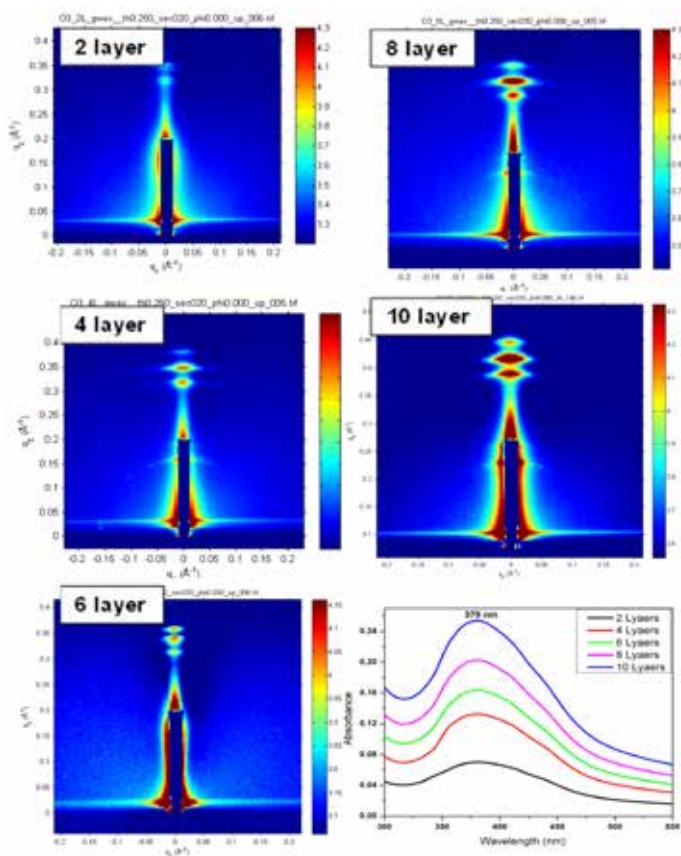

Figure 3. Two-dimensional (2D) X-ray (graze incidence wide angle X-ray, GIWAX) of multilayered thin films of oligothiophene self-assemblies from 2 layers to 10 layers. Increasing diffraction intensity as a function of layer number is consistent with the increase absorption intensity of UV-Vis spectra of the multilayered thin film.

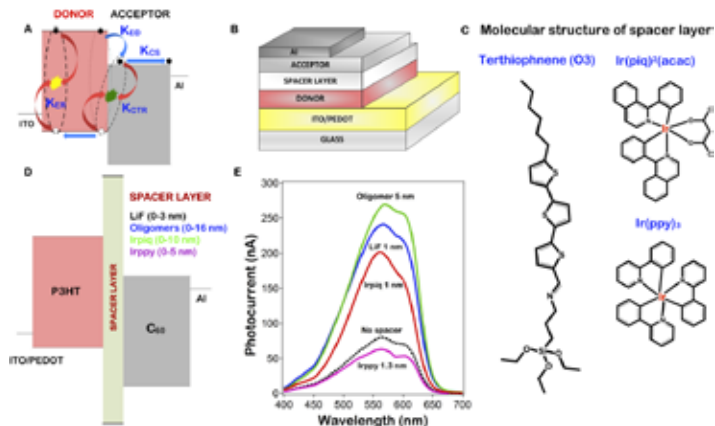

Figure 5. A) Photo-physical processes and corresponding generation/dissociation/recombination rates in organic solar cells: (i) exciton generation and migration to the interface, which competes with exciton recombination; (ii) exciton dissociation to charge-transfer (CT) state; (iii) CT state dissociation, which competes with CT state recombination. (B) Bilayer device geometry (C) molecular structures of O3, Ir(piq)₂(acac) and Ir(ppy)₃ spacer layers; (D) strategies used in this study for inserting spacer layers at the P3HT/C60 interface. (E) Photocurrent versus excitation wavelength measured under short-circuit conditions without (dashed black curve) and with (solid color curves) spacer layers.

Publications

- Alberti, S. F., V. D. Kleiman, T. Nelson, A. E. Roitberg, and S. Tretiak. Shishiodoshi unidirectional energy transfer mechanism in phenylene ethynylene dendrimers. 2012. *Journal of Chemical Physics*. 137: 22A526.
- Bjorggaard, J. A., K. A. Velizhanin, and S. Tretiak. Excited State Dynamics in Substituted Donor-Acceptors Conjugated Chromophores in the Presence of Solvent Environment. *Journal of Chemical Physics*.
- Campbell, I. H., and B. K. Crone. Improving an organic photodiode by incorporating a tunnel barrier between the donor and acceptor layers. 2012. *APPLIED PHYSICS LETTERS*. 101 (2): 023301.
- Clark, J., T. Nelson, S. Tretiak, G. Cirimi, and G. Lanzani. Femtosecond torsional relaxation. 2012. *Nature Physics*. 8 (3): 225.
- Coughlin, J. E., Zhugayevych, R. C. Bakus II, T. S. van der Poll, G. C. Welch, S. J. Teat, G. C. Bazan, and Tretiak. A Combined Experimental and Theoretical Study of Conformational Preferences of Molecular Semiconductors. 2014. *JOURNAL OF PHYSICAL CHEMISTRY C*. 118 (29): 15610.
- Crooker, S. A., F. Liu, M. R. Kelley, N. J. D. Martinez, W. Nie, A. Mohite, I. H. Nayyar, S. Tretiak, D. L. Smith, and P. Ruden. Spectrally-resolved hyperfine interactions between polaron and nuclear spins in organic light emitting diodes: Magneto-EL studies. To appear in *Applied Physics Letters*.
- Du, C. H., H. L. Wang, Pu, T. L. Meyer, P. M. Woodward, F. Y. Yang, and P. C. Hammel. Probing the Spin Pumping Mechanism: Exchange Coupling with Exponential Decay in Y3Fe5O12/Barrier/Pt Heterostructures. 2013. *PHYSICAL REVIEW LETTERS*. 111 (24).
- Fernandez-Alberti, S., A. Roitberg, T. Nelson, and S. Tretiak. Identification of unavoided crossings in nonadiabatic photoexcited dynamics involving multiple electronic states in polyatomic conjugated molecules. 2012. *Journal of Chemical Physics*. 137 (1): 014512 (10 pp.).
- Furmanchuk, A., J. Leszczynski, S. Tretiak, and S. Kilina. Morphology and optical response of carbon nanotubes functionalized by conjugated polymers. 2012. *Journal of Physical Chemistry C*. 116 (12): 6831.
- Galindo, J. F., E. Atas, A. Altan, D. G. Kuroda, S. Tretiak, S. Fernandez-Alberti, V. Kleiman, and A. E. Roitberg. Dynamics of Energy transfer in a Conjugated dendrimer Driven by Ultrafast Localization of Excitons. *Nature Chemistry*.
- Gorshkov, V. N., S. Tretiak, and D. Mozyrsky. Semiclassical Monte-Carlo approach for modelling non-adiabatic dynamics in extended molecules. 2013. *NATURE COMMUNICATIONS*. 4: -.
- Kang, , Xu, Chen, B. i. n. Zhang, Du, Han, Li, and Wang. Amino Acid-Assisted Synthesis of Hierarchical Silver Microspheres for Single Particle Surface-Enhanced Raman Spectroscopy. 2013. *JOURNAL OF PHYSICAL CHEMISTRY C*. 117 (19): 10007.
- Kilina, S., E. Batista, A. Saxena, D. L. Smith, R. L. Martin, and S. Tretiak. Effect of Packing on Formation of Deep Carrier Traps in Amorphous Conjugated Polymers. 2013. *Journal of Physical Chemistry Letters*. 4: 1453.
- Kilina, S., J. Ramirez, and S. Tretiak. Brightening of the lowest exciton in carbon nanotubes via chemical functionalization. 2012. *Nano Letters*. 12 (5): 2306.
- Kuo, , Huang, Hsiow, Yang, Huang, Rwei, Wang, and Wang. Effect Side-Chain Architecture on the Optical and Crystalline Properties of Two-Dimensional Polythiophenes. 2013. *MACROMOLECULES*. 46 (15): 5985.
- Kuo, , Nie, Tsai, Yen, A. D. Mohite, Gupta, A. M. Dattelbaum, D. J. William, K. C. Cha, Yang, Wang, and Wang. Structural Design of Benzo[1,2-b:4,5-b']dithiophene-Based 2D Conjugated Polymers with Bithienyl and Terthienyl Substituents toward Photovoltaic Applications. 2014. *MACROMOLECULES*. 47 (3): 1008.
- Lai, L., J. Love, A. Sharenko, J. Coughlin, V. Gupta, S. Tretiak, T. Nguyen, W. Wong, and G. Bazan. Topological Considerations for the Design of Molecular Donors with Multiple Absorbing Units. 2014. *JOURNAL OF THE AMERICAN CHEMICAL SOCIETY*. 136 (15): 5591.
- Li, H., C. Wu, S. V. Malinin, S. Tretiak, and V. Y. Chernyak. Exciton Scattering Approach for Optical Spectra Calculations in Branched Conjugated Macromolecules. To appear in *Accounts on Chemical Research*.
- Li, H., M. J. Catanzaro, Tretiak, and V. Y. Chernyak. Excited-State Structure Modifications Due to Molecular Substituents and Exciton Scattering in Conjugated Molecules. 2014. *JOURNAL OF PHYSICAL CHEMISTRY LETTERS*. 5 (4): 641.
- Li, H., Nieman, A. J. A. Aquino, Lischka, and Tretiak. Comparison of LC-TDDFT and ADC(2) Methods in Computations of Bright and Charge Transfer States in Stacked Oligothiophenes. 2014. *JOURNAL OF CHEMICAL THEORY AND COMPUTATION*. 10 (8): 3280.
- Li, H., T. Shi, S. Tretiak, and V. Y. Chernyak. How Geometric Distortions Scatter Electronic Excitations in Conjugated Macromolecules. *Journal of Physical Chemistry Letters*.
- Liu, , Wang, and Cotlet. Energy Transfer from a Cationic Conjugated Polyelectrolyte to a DNA Photonic Wire: Toward Label-Free, Sequence-Specific DNA Sensing.

2014. CHEMISTRY OF MATERIALS. 26 (9): 2900.
- Liu, F. L., B. K. Crone, P. P. Ruden, and D. L. Smith. Control of interface microscopic processes in organic bilayer structures and their effect on device performance. 2013. Journal of Applied Physics. 113: 044516.
- Liu, F., P. Paul. Ruden, I. H. Campbell, and D. Smith. Electrostatic capacitance in single and double layer organic diodes. 2012. APPLIED PHYSICS LETTERS. 101 (2): 023501.
- Liu, F., P. Paul. Ruden, I. H. Campbell, and D. Smith. Device model for electronic processes at organic/organic interfaces. 2012. JOURNAL OF APPLIED PHYSICS. 111 (9): 094507.
- Nayyar, I. H., E. R. Batista, S. Tretiak, A. Saxena, D. L. Smith, and R. L. Martin. Effect of trans- and cis-isomeric defects on the localization of the charged excitations in π -conjugated organic polymers. 2013. JOURNAL OF POLYMER SCIENCE PART B-POLYMER PHYSICS. 51 (12): 935.
- Nayyar, I., E. Batista, S. Tretiak, A. Saxena, D. L. Smith, and R. L. Martin. Role of Geometric Distortion and Polarization in Localizing Electronic Excitations in Conjugated Polymers. 2013. Journal of Chemical Theory and Computations. 9: 1144.
- Nelson, , Fernandez-Alberti, A. E. Roitberg, and Tretiak. Artifacts due to trivial unavoided crossings in the modeling of photoinduced energy transfer dynamics in extended conjugated molecules. 2013. CHEMICAL PHYSICS LETTERS. 590: 208.
- Nelson, , Fernandez-Alberti, A. E. Roitberg, and Tretiak. Nonadiabatic Excited-State Molecular Dynamics: Modeling Photophysics in Organic Conjugated Materials. 2014. ACCOUNTS OF CHEMICAL RESEARCH. 47 (4): 1155.
- Nelson, T., S. Fernandez-Alberti, A. E. Roitberg, and S. Tretiak. Nonadiabatic excited-state molecular dynamics: Treatment of electronic decoherence. 2013. JOURNAL OF CHEMICAL PHYSICS. 138 (22): -.
- Nelson, T., S. Fernandez-Alberti, A. E. Roitberg, and S. Tretiak. Conformational disorder in energy transfer: beyond Forster theory. 2013. PHYSICAL CHEMISTRY CHEMICAL PHYSICS. 15 (23): 9245.
- Nelson, T., S. Fernandez-Alberti, V. Chernyak, A. Roitberg, and S. Tretiak. Nonadiabatic excited-state molecular dynamics: Numerical tests of convergence and parameters. 2012. Journal of Chemical Physics. 136 (5): 054108.
- Nie, W., G. Gupta, B. Crone, F. Liu, D. L. Smith, P. Ruden, C. Kuo, H. Tsai, H. L. Wang, H. Li, S. Tretiak, and A. D. Mohite. Interface Design Principles for High Efficiency Organic Semiconductor Devices. Nature Materials.
- Nie, W., G. Gupta, B. Crone, H. L. Wang, and A. Mohite. Design principle for efficient charge separation at the donor-acceptor interface for high performance organic solar cell device. 2014. Bulletin of the American Physical Society. 59: 59.
- Nie, W., T. Hsinhan, R. Asadpour, J. C. Blancon, R. Kappera, M. Chhowalla, A. Neukirch, S. Tretiak, G. Gupta, J. Crochet, M. A. Alam, H. L. Wang, and A. D. Mohite. High Efficiency Millimeter Scale Crystalline Perovskite Solar Cells. Nature Materials.
- Oldani, , Tretiak, Bazan, and Fernandez-Alberti. Modeling of internal conversion in photoexcited conjugated molecular donors used in organic photovoltaics. 2014. ENERGY & ENVIRONMENTAL SCIENCE. 7 (3): 1175.
- Ondarse-Alvarez, D., N. Oldani, S. Tretiak, and S. Fernandez-Alberti. Computational Study of Photoexcited Dynamics in Bichromophoric Cross-shaped Oligofluorene. To appear in Journal of Physical Chemistry C.
- Park, Y. I., C. Y. Kuo, J. S. Martinez, Y. S. Park, O. Postupna, A. Zhugayevych, S. Kim, J. Park, S. Tretiak, and H. L. Wang. Tailored Electronic Structure and Optical Properties of Conjugated Systems through Aggregates and Dipole-Dipole Interactions. 2013. ACS APPLIED MATERIALS & INTERFACES. 5 (11): 4685.
- Park, Y. I., Park, Gao, J. K. Grey, Wang, M. A. Johal, Park, H. Y. Woo, and Wang. Water-soluble PPV and C-60 nanocomposite with enhanced miscibility and enhanced photo-induced charge transfer through ground state electrostatic interactions. 2014. POLYMER. 55 (3): 855.
- Park, Y. I., Zhang, Kuo, J. S. Martinez, Park, Mallapragada, and Wang. Stimuli-Responsive Poly-N-isopropylacrylamide: Phenylene Vinylene Oligomer Conjugate. 2013. JOURNAL OF PHYSICAL CHEMISTRY C. 117 (15): 7757.
- Park, Y., A. Zhugayevych, O. Postupna, S. W. Kyu, Y. S. Park, B. Park, J. S. Martinez, J. Park, S. Tretiak, and H. L. Wang. A New pH Sensitive Fluorescent and White Emission Material through Controlled Intermolecular Charge Transfer. To appear in Chemical Sciences.
- Poll, T. S., A. Zhugayevych, E. Chertkov, R. C. Bakus, J. Coughlin, S. J. Teat, G. C. Bazan, and S. Tretiak. Polymorphism of Crystalline Molecular Donors for Solution-Processed Organic Photovoltaics. 2014. Journal of Physical Chemistry Letters. 5: 2700.
- Sampat, S., A. D. Mohite, B. Crone, S. Tretiak, A. Malko, A. J. Taylor, and D. A. Yarotski. Tunable Charge Transfer Dynamics at Tetracene/LiF/C60 Interfaces. Journal of Physical Chemistry C.

-
- Sheng, C. X., S. Singh, A. Gambetta, T. Drori, M. Tong, S. Tretiak, and Z. V. Vardeny. Ultrafast intersystem-crossing in platinum containing pi-conjugated polymers with tunable spin-orbit coupling. 2013. SCIENTIFIC REPORTS. 3: -.
- Soler, M. A., A. E. Roitberg, T. Nelson, S. Tretiak, and S. F. Alberti. Analysis of state-specific vibrations coupled to the unidirectional energy transfer in conjugated dendrimers. 2012. Journal of Physical Chemistry A. 116: 9802.
- Soler, M. A., T. Nelson, A. E. Roitberg, S. Tretiak, and S. Fernandez-Alberti. Signature of Nonadiabatic Coupling in Unique Excited-State Vibrational Modes. To appear in Journal of Physical Chemistry C.
- White, A. J., V. N. Gorshkov, R. Wang, S. Tretiak, and D. Mozysky. Semiclassical Monte-Carlo: A First Principles Approach to Nonadiabatic Molecular Dynamics. Journal of Chemical Physics.
- Xu, , Chang, Y. I. Park, B. i. n. Zhang, Kang, Du, R. S. Iyer, and Wang. Conjugated polymer mediated synthesis of nanoparticle clusters and core/shell nanoparticles. 2013. POLYMER. 54 (2): 485.
- Yen, , Tsai, Kuo, Nie, A. D. Mohite, Gupta, Wang, Wu, Liou, and Wang. Flexible memory devices with tunable electrical bistability via controlled energetics in donor-donor and donor-acceptor conjugated polymers. 2014. JOURNAL OF MATERIALS CHEMISTRY C. 2 (22): 4374.
- Zhugayevych, A., O. Postupna, H. L. Wang, and S. Tretiak. Modification of electronic and optical properties in donor/acceptor substituted conjugated oligomers: DFT and semiempirical study. Journal of Physical Chemistry C.
- Zhugayevych, A., O. Postupna, R. Bakus , G. Welch, G. Bazan, and S. Tretiak. Ab-initio study of a molecular crystal for photovoltaics: light absorption, exciton and charge carrier transport. 4920. Journal of Physical Chemistry C. 117: 2013.
- Zhugayevych, A., and S. Tretiak. Theoretical Description of Structural and Electronic Properties of Organic Photovoltaic Materials. To appear in Annual Review of Physical Chemistry.

Plutonium-242: A National Resource for the Fundamental Understanding of 5f Electrons

Eric D. Bauer
20120024DR

Abstract

The complex and emergent behavior of the 5f electrons of Pu arising from its unique position in the periodic table remains an enigma to this day and poses one of the most significant challenges to the scientific community and to DOE's national security missions. Sustaining the aging nuclear stockpile at significantly reduced levels demands a fundamental understanding of Pu's 5f electrons beyond what is currently known. A suite of state-of-the-art experimental techniques developed here and at national user facilities in the last decade provides an exciting opportunity to finally unravel the complexity of plutonium. Our approach to this problem consists of performing these premier experiments, which are enabled by single crystals of delta-Pu and Pu compounds containing the isotope Pu-242. Over the course of the approximately two-year project, we have provided—for the first time—crucial benchmarks for the most advanced first-principles dynamical mean field theory and density functional theoretical methods at our disposal. The fundamental and comprehensive understanding of the 5f electrons of plutonium obtained through determination of several critical aspects of plutonium's electronic structure has provided the scientific basis for Pu's equation of state, phase stability, and phase transformation kinetics under extreme conditions. These state-of-the-art experiments and calculations, in addition to the new capabilities developed over the course of the project are important contributions to the continued success of NNSA/DOE's and the Lab's stockpile sustainability missions.

Background and Research Objectives

Plutonium is arguably the most complex element in the periodic table. Plutonium's complex electronic structure is due to its position in the actinide series where 5f electrons move from being tied to the atoms (localization) to freely moving around the metal (itineracy). Understanding the behavior of the 5f electrons at this crossover poses a significant challenge to the condensed matter

community. As a major step to address the challenge of understanding the 5f electrons of Pu, we synthesized high-purity single crystals of delta-242^{Pu} and 242^{Pu}-based compounds containing the special isotope Pu-242 to, for the first time: 1) use advanced photon spectroscopies to determine the valence of Pu's 5f electrons, which will significantly constrain current theories of Pu electronic states; 2) apply novel photon spectroscopy and neutron scattering techniques to determine the magnetic configuration of delta-Pu's 5f electrons and their charge/spin fluctuations, resolving a decades-long debate; and 3) perform seminal measurements of the electronic band structure of delta-Pu using our unique angle-resolved photoemission capability to significantly constrain equation of state models. The fundamental and comprehensive understanding of the 5f electrons of Pu obtained through this integrated effort in experiment and theory contributes to the scientific basis for Pu's equation of state, phase stability, and phase transformation kinetics under extreme conditions. Our work stretches the Lab's expertise in characterizing and modeling complex materials, as well as revitalizing plutonium science in this country and making it an attractive field of study for the next generation of LANL scientists; it is a crucial step towards fulfilling LANL's role as the Plutonium Center of Excellence and the Plutonium Science Strategy.

As described in more detail below, our most significant accomplishments towards a fundamental understanding of the 5f electrons of plutonium include: 1) the most accurate determination of the electronic configuration, or mixed-valence, of Pu's 5f electrons in both delta-Pu and alpha-Pu; 2) the observation of a fluctuating magnetic moment in delta-Pu, which resolves a 30-year-old mystery about Pu; 3) the observation of the Pu-239 nuclear magnetic resonance in PuO₂, defining a powerful new tool for the exploration of Pu's 5f electrons in chemistry, physics, and materials science; and 4) the most advanced theoretical understanding of alpha-Pu using

dynamical mean field theory.

These accomplishments were achieved despite severe budget pressure due to the mid-FY14 imposition of the 6% budget cap. As a consequence, we were not able to perform measurements of the electronic band structure of delta-Pu by angle-resolved photoemission.

Scientific Approach and Accomplishments

We started the project to understand Pu's 5f electrons by preparing several Pu alloys and compounds in single crystal form and with the Pu-242 isotope, which due to its special nuclear properties is best for neutron scattering. We were successful in our attempts to grow large single grains of delta-Pu up to 1.3 mm in diameter. Starting with fine-grained Ga-stabilized delta-Pu, we strained the material between 2-4%, then annealed for 100 hours at about 400 C. This produced a number of large single grains, a couple of which are large enough to carry out band structure measurements of delta-Pu via angle-resolved photoemission (ARPES) for the first time. In addition, we made single crystals of the plutonium superconductors PuCoGa₅, PuRhIn₅, and PuCoIn₅. These "Pu115" materials undergo a volume change of 30%, accompanied by a change in the behavior of Pu's 5f electrons, but remain in the same crystal structure. Thus, these interesting superconductors provide a unique opportunity to understand the phase transformations in pure plutonium, which also undergo changes in volume up to 25% when delta-Pu transforms to alpha-Pu.

In work that provides a new framework for understanding the behavior of plutonium's 5f electrons, our measurements of resonant inelastic x-ray scattering provide the first clear evidence of multiconfigurational f-orbital states—in other words a quantum mechanical mixture of distinct 5f configurations (e.g., 5f⁴, 5f⁵, and 5f⁶)—in the electronic ground state of Pu and a wide range of Pu compounds (Figure 1a and b). This research provided the most accurate determination of the valence of elemental Pu to date. Extending these measurements to U- and Pu-based intermetallic compounds supports the notion that such ground states are ubiquitous in these materials. They also advance a new paradigm for understanding light actinides based upon a 5f-electron multiconfigurational ground state that goes far beyond a "dual nature" scenario. This work was published in the Proceedings of the National Academy of Sciences and could have far-reaching consequences for understanding the actinide series.

In collaboration with visiting Seaborg Scholar Hiroshi Yasuoka and the LANL Seaborg Institute, we have determined the important physical constant, the gyromagnetic ratio, of plutonium-239 in PuO₂ that will allow future studies

of plutonium alloys and intermetallic compounds by this technique. This "fingerprint" of plutonium's nucleus will allow us to study its 5f electrons, which play a decisive role in controlling the metallurgy and chemical reactivity of plutonium alloys and compounds, in Pu's structural instability, and the degree of localization/itineracy of its 5f electrons. This work has recently been published in the journal Science.

For the past 30 years, conventional first-principles electronic structure calculations fail spectacularly in computing the atomic volume of delta-Pu. In order to correct this problem, theorists had to make Pu's 5f electrons very localized around the atomic core, which produced static magnetic order. But experiments over the years have not found evidence for this static magnetism, thus leading to a conundrum that has puzzled theorists and experimentalists alike—where is the magnetic moment of plutonium? One possibility is that the magnetic moment is not static, but fluctuates in time. To explore this possibility, we performed seminal measurements of the magnetic fluctuation spectrum in large polycrystalline samples of delta-242[^]Pu (22 g) at the Spallation Neutron Source at Oak Ridge National Laboratory and at the Lujan Center at LANL. We found evidence for a magnetic anomaly centered at 90 meV (see Figure 1c) and derived a magnetic form factor of plutonium (or the magnetization density around the nucleus)—for the first time ever. All indications are that this feature is a signature of Pu's magnetic moment that fluctuates in time and is not static. Thus, we determined the origin of the missing magnetism in delta-Pu, resolving a debate that has persisted for more than 30 years. This work has been submitted to the journal Science.

In a three-pronged effort, the theoretical work for the project spanned the range from providing exact solutions in the extreme itinerant limit (local density approximation), to the localized limit (hybrid functionals), and in between these limits where the Coulomb repulsion and kinetic energies of the 5f electrons are comparable, as embodied in the dynamical mean field theory (DMFT). In a tour de force effort, we recently completed calculations on alpha-Pu, for the first time, within the framework of density functional theory (DFT) and the generalized gradient approximation (GGA) together with dynamical mean-field theory (DMFT). In short, alpha Pu appears to have the capacity to simultaneously have multiple degrees of electron localization/delocalization of Pu 5f electrons due to the wide range of Pu-Pu bonds within this elemental phase of Pu. This comprehensive set of advanced theoretical tools provides a powerful framework to attack a wide range of complex problems in the actinide series and beyond.

We carried out a number of measurements on the PuMIn₅ and PuMGa₅ (M=Co, Rh) superconductors to investigate the effects of the 30% volume collapse from PuRhIn₅ to PuCoGa₅, which is similar to the volume difference between alpha-Pu and delta-Pu. By performing resonant ultrasound measurements on a single crystal of PuCoGa₅, which is most similar to delta-Pu, we extracted all six elastic constants of this tetragonal system. Analysis of the superconducting and normal states reveal that only the compressional modes show an anomaly below the superconducting transition and further indicate an unusual softening of the lattice below 50 K. These results suggest that valence fluctuations may mediate the superconductivity in PuCoGa₅. In addition, the results provide direct evidence for the influence of the 5f electrons in the mechanical (e.g., bulk modulus) and electronic properties, which are important for the determination of the initial equation of state. Extensive measurements on the PuRh(In_{1-x}Cdx)₅ single crystals reveal that long-range antiferromagnetic (AFM) order is found for $x > 0.07$ Cd with a narrow region of coexistent superconductivity and AFM order. This is the first example of such interplay between superconductivity and magnetism in a plutonium compound. To further explore the nature of the 5f electrons of plutonium in these materials, we performed angle-resolved photoemission (ARPES) and x-ray photoemission spectroscopy (XPS) measurements on single crystals of PuCoIn₅, PuPt₂In₇, and PuCoGa₅. These experiments reveal the degree of localization of the Pu 5f electrons. The ARPES measurements also reveal the electronic band structure, which when compared to dynamical mean field theory, delineate the degree of hybridization of the 5f and conduction electron states that characterize the strong electronic correlations in these materials.

Our team has performed approximately 1 experiment per month on Pu and its compounds at National User facilities. These experiments, closely coupled with advanced theoretical calculations, have resulted in 2 plenary talks and 13 invited talks at international conferences, and 22 publications (published or submitted), including several high-profile ones in Science or the Proceedings of the National Academy of Sciences. A mid-project review conducted in January, 2013, included on the review panel one of the world's foremost experts on plutonium and former Laboratory Director, Sig Hecker. The panel concluded our project was "Outstanding". As one of the review panel members explained "The quality of the work is astounding and the amount and diversity is overwhelming. Certainly the experimental achievements are leading the field at the international level." In addition, one organizer of the international Plutonium Futures conference stated "I have heard several accounts by participants that the neutron

scattering measurement [by this team] was one of the most important measurements on plutonium in a generation." These accolades attest to the quantity and quality of the work performed by our team in this short (2-year) DR project on understanding the 5f electrons of plutonium.

Impact on National Missions

Over the course of our DR project, we have made significant strides in understanding the 5f electrons of plutonium. The experiments and theoretical calculations performed on Pu and its compounds provide valuable input for Pu's equation of state, phase stability, and phase transformation kinetics under extreme conditions. Several seminal measurements on delta-Pu were carried out, which has helped settle decades-old debates and, more importantly, defines new directions for explore built upon the scientific foundation this project has provided. The development of a new strain-anneal capability for growing large single grains of delta-Pu may be particularly useful in both casting of plutonium and in the modelling of such casting moulds. In addition, the suite of theoretical tools applied to understand the 5f electrons of Pu in this project may be used to tackle a range of complex problems in the actinide series and other materials of interest to LANL in support of NNSA/DOE's and the Lab's stockpile sustainability missions. Finally, three LDRD Early Career recipients and several postdoctoral researchers worked on this project, which highlights that it has served to revitalize interest in plutonium science for the next generation of actinide scientists.

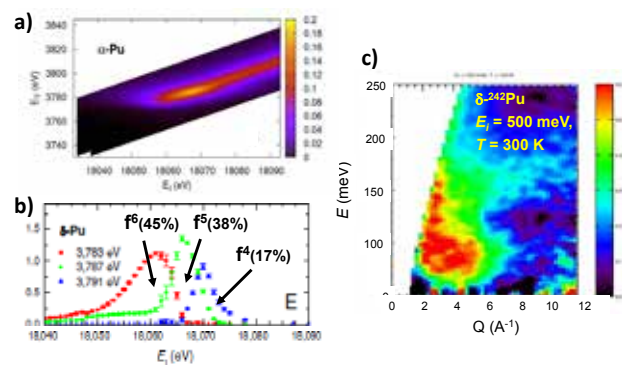

Figure 1. a) Resonant X-ray Emission Spectroscopy (RXES) of alpha-Pu. Panel a) illustrates the resonance in a plot of incident x-ray energy (E_i) of the Pu L-alpha x-ray transition vs energy transfer (E). From these data, the individual configurations of 5f₄, 5f₅, and 5f₆ of the multiconfigurational ground state of alpha and delta-Pu have been determined, as shown in panel b). Panel c) shows the signature of the fluctuating magnetic moment, (red feature) centered at 90 meV in the energy (E) vs momentum transfer (Q) of the scattered neutrons. These neutron scattering measurements were performed on delta-242Pu at the Spallation Neutron Source at ORNL.

Publications

- Bauer, E. D., M. M. Altarawneh, P. H. Tobash, K. Gofryk, O. E. Ayala-Valenzuela, J. N. Mitchell, R. D. McDonald, C. H. Mielke, F. Ronning, J. C. Griveau, E. Colineau, R. El-oiri, R. Caciuffo, B. L. Scott, O. Janka, S. M. Kauzlarich, and J. D. Thompson. Localized 5f electrons in superconducting PuCoIn 5 : consequences for superconductivity in PuCoGa 5. 2012. *Journal of Physics: Condensed Matter*. 24 (5): 052206.
- Bauer, E. D., P. H. Tobash, J. N. Mitchell, and J. L. Sarrao. Single crystal growth of plutonium compounds from molten metal fluxes. 2012. *Philosophical Magazine*. 92 (19-21): 2466.
- Booth, C. H., S. A. Medling, Y. Jiang, E. D. Bauer, P. H. Tobash, J. N. Mitchell, D. K. Veirs, M. A. Wall, P. G. Allen, J. J. Kas, D. Sokaras, D. Nordlund, and T. C. Weng. Delocalization and occupancy effects of 5f orbitals in plutonium intermetallics using L3-edge resonant X-ray emission spectroscopy. 2014. *Journal of Electron Spectroscopy and Related Phenomena*. 194 (0): 57.
- Booth, C. H., Y. Jiang, D. L. Wang, J. N. Mitchell, P. H. Tobash, E. D. Bauer, M. A. Wall, P. G. Allen, D. Sokaras, D. Nordlund, T. C. Weng, M. A. Torrez, and J. L. Sarrao. Multiconfigurational nature of 5f orbitals in uranium and plutonium intermetallics. 2012. *Proceedings of the National Academy of Sciences of the United States of America*. 109 (26): 10205.
- Chudo, H., G. Koutroulakis, H. Yasuoka, E. D. Bauer, P. H. Tobash, J. N. Mitchell, and J. D. Thompson. Weak itinerant antiferromagnetism in PuIn 3 explored using 115 In nuclear quadrupole resonance. 2014. *Journal of Physics: Condensed Matter*. 26 (3): 036001.
- Haga, Y., E. D. Bauer, P. H. Tobash, J. N. Mitchell, O. Ayala-Valenzuela, R. D. McDonald, C. H. Mielke, and Z. Fisk. Shubnikov-de Haas oscillation in PuIn3. 2013. *Journal of the Korean Physical Society*. 63 (3): 380.
- Il, M. F. Beaux, J. J. Joyce, T. Durakiewicz, K. S. Graham, E. D. Bauer, P. H. Tobash, and S. Richmond. Electronic Structure, Localization and 5f Occupancy in Pu Materials. 2012. *Materials Research Society Symposium Proceedings*. 1444: 123.
- Janoschek, M., D. Haskel, J. Fernandez-Rodriguez, M. v. Veenendaal, Y. Choi, J. Rebizant, G. H. Lander, J. D. Thompson, and E. D. Bauer. The Ground State Wavefunction of Plutonium in PuSb as determined via X-ray Magnetic Circular Dichroism. *Journal of Physics: Condensed Matter*.
- Janoschek, M., P. Das, J. N. Mitchell, S. Richmond, M. Ramos, J. X. Zhu, M. D. Lumsden, D. Abernathy, G. Lander, G. Kotliar, M. E. Pezzoli, B. Chakraborty, K. Haule, F. Trouw, and J. D. Thompson. Fluctuating Magnetic Moment in delta-Pu. *Science*.
- Koutroulakis, G., A. M. Mounce, M. Wartenbe, N. Ghimire, H. Yasuoka, M. Jaime, R. D. McDonald, P. H. Tobash, J. N. Mitchell, E. D. Bauer, and J. D. Thompson. Plutonium superconductivity near an antiferromagnetic quantum critical point. *Proceedings of the National Academy of Sciences of the United States of America*.
- Koutroulakis, G., H. Yasuoka, H. Chudo, P. H. Tobash, J. N. Mitchell, E. D. Bauer, and J. D. Thompson. Microscopic properties of the heavy-fermion superconductor PuCoIn 5 explored by nuclear quadrupole resonance. 2014. *New Journal of Physics*. 16 (5): 053019.
- Mitchell, J. N., F. J. Freibert, and D. S. Schwartz. Phase transitions in pure plutonium. *Materials Research Society Symposium Proceedings*.
- Mitchell, T. E., J. P. Hirth, D. S. Schwartz, and J. N. Mitchell. The beta-to-alpha phase transformation in plutonium. 2013. *Acta Materialia*. 61: 2895.
- Ramshaw, B. J., A. Shekhter, R. D. McDonald, J. B. Betts, J. N. Mitchell, P. H. Tobash, E. D. Bauer, C. H. Mielke, and A. Migliori. Avoided Valence Transition in a Plutonium Superconductor. *Nature Communications*.
- Rhee, H. B., F. Ronning, J. X. Zhu, E. D. Bauer, J. N. Mitchell, P. H. Tobash, B. L. Scott, J. D. Thompson, Y. Jiang, C. H. Booth, and W. E. Pickett. PuPt₂In₇: A computational and experimental investigation. 2012. *Physical Review B*. 86: 115137.
- Rudin, S. P. Density Functional Theory Calculation Study of the Entangled Crystal, Magnetic, and Electronic Structures of PuGa3. arXiv:1307.0762.
- Wang, C. C., M. D. Jones, and J. Zhu. Fermi surface topology and de Haas-van Alphen orbits in PuIn₃ and PuSn₃ compounds. 2013. *Physical Review B*. 88 (12): 125106.
- Yasuoka, H., G. Koutroulakis, H. Chudo, S. Richmond, D. K. Veirs, A. I. Smith, E. D. Bauer, J. D. Thompson, G. D. Jarvinen, and D. L. Clark. Observation of Pu-239 Nuclear Magnetic Resonance. 2012. *Science*. 336: 901.
- Zhu, J. X., P. H. Tobash, E. D. Bauer, F. Ronning, B. L. Scott, K. Haule, G. Kotliar, R. C. Albers, and J. M. Wills. Electronic structure and correlation effects in PuCoIn 5 as compared to PuCoGa 5. 2012. *Europhysics Letters*. 97 (5): 57001.
- Zhu, J., R. C. Albers, K. Haule, G. Kotliar, and J. M. Wills. Site-selective electronic correlation in α -plutonium metal. 2013. *Nature Communications*. 4: 2644.

Genetically Encoded Materials: Libraries of Stimuli-responsive Polymers

Jennifer Martinez
20120029DR

Abstract

Nature creates adaptable materials that respond dynamically to their environment, converting one type of signal into another. Likewise, man-made “smart polymers” can adapt, sense or react to their environment, converting one type of signal into another signal or functionality. These polymers impact diverse fields such as drug delivery, diagnostics, tissue engineering, and molecular electronics, and are only skimming the surface of their potential. In vivo polymers are engineered protein polymers with control over structure and function unparalleled by synthetic polymers. We have created large, diverse libraries of in vivo polymers that react biologically and rapidly identified functional materials using a genetic technique akin to evolution. Our goal is to develop a platform technology that allows us to select materials that are biologically, thermally, or optically responsive. Realization of this potential required three significant breakthroughs: 1) creation of polymer libraries; 2) development of methods for selecting stimuli-responsive polymers based on functions; and 3) understanding of functional polymers. These materials are expected to impact diverse fields such as implantable sensors, and optical electronics and solar harvesting (i.e. stimuli responsive fluorescent or elastic charge-transfer materials).

Background and Research Objectives

The next revolution in bioengineering and materials science will be the first-principles design and synthesis of materials with specific emergent properties. Stimuli-responsive polymers, in particular, are an exciting class of materials that can be created to adapt, sense, and interact with their environment. Recent advances in this area suggest, for example, that cell niches for regenerative medicine or molecular electronics for LEDs can be made, if only we can accurately control the function of polymers (Figure 1).

Unfortunately, the a priori design of stimuli-responsive materials is difficult, because design of a polymer that changes structure and/or function as a result of a physical or chemical stimulus, is difficult to predict. Until now, synthetic or biological polymers have been typically synthesized and tested one-by-one, limiting the number of different polymers that can be effectively explored. Consequently, a combinatorial approach may be a powerful route toward the development of polymers with ideal functionalities. For combinatorial polymer chemistry to work, novel methods are needed to: (1) generate diverse libraries and (2) rapidly identify promising materials based on function and/or physical properties. Traditional combinatorial polymers approaches are very limited, both because it is difficult to make large synthetic polymer libraries and, more importantly, it is virtually impossible to identify individually functional polymers from mixtures.

We tackled these problems by: (1) creating large, diverse libraries of genetically engineered in vivo polymers, with incorporated optical- and bio-reactive moieties, and (2) rapidly identifying functional materials using a genetic technique akin to evolution. In vivo polymers are genetically engineered protein polymers that are an exciting class of materials with extraordinary monodispersity, well-defined stereochemistries, sequences, and the ability to form hierarchical assemblies; attributes that are all critical for polymer functionality, yet not always attainable by chemical polymerization (Figure 1).

In vivo polymers are genetically encoded polymers with defined sequence and physical properties: In vivo polymers: are physically robust and elastic; can be crosslinked; and can have reversible temperature and pH transitions (phase changes) that depend on scaffold sequence. Classes of in vivo polymers include elastin-like (ELPs), silk-like (SLPs), silk-elastin-like (SELPs), helical bundles, and sheet forming polymers, among many others. Unlike the proteins we often think of, genetically en-

gineered polymers, like synthetic polymers, consist of short repeating sequence units that define their physical properties. In vivo polymers are monodisperse and regioregular. Thus, the genetic encoding of in vivo polymers allows exacting control of function, so as to produce the emergent properties that we sought in this proposal; attributes difficult to achieve via conventional rationally designed synthetic approaches. Further, the genetic engineering of in vivo polymers allows us to create libraries of millions of related, yet different, polymers

Creating massive polymer libraries in vivo and displaying them for facile selection will be a powerful and novel technique to quickly isolate sequences specific for a function (i.e. adhesive to bone cells or optically reactive): Combinatorial polymers chemistry (synthetic) has been hampered by the inability to produce large libraries and a means to rapidly identify functional polymers (no ID-tag). Nevertheless, one of the more highly publicized examples of biocompatible polymer creation was a one-by-one screening of 600 different acrylate polymers. Here the investigators were able to create materials, which specifically interacted with cellular proteins and induced embryonic stem-cell differentiation. These results are exciting and where the first suggestion that a combinatorial approach incorporating far larger libraries (i.e. $>10^8$, as shown here), with greatly improved methods of selection, will evolve polymers with new and interesting properties. Beyond the ability to create large libraries of materials, Nature also beats synthesis through methods for screening large libraries in high-throughput. In yeast and phage display, proteins (i.e. polymers) are “displayed” on the surface of a microorganism (i.e. phage) by fusing the gene for that polymer to the gene of a surface protein of phage. We thus genetically engineer a phage display “library” of many different polymers, in which each phage “vehicle” couples an internal DNA to an externally displayed polymer. The benefit of in vivo combinatorial selections is that each phage carries one polymer and the DNA that encodes for that sequence (enabling self replication), thus an efficient ID-tag system (one-polymer/one-phage/one-DNA). Further, the same library can be used to select polymers with different functions, thus we can correlate sequence families to properties, enabling discovery of design motifs and downstream materials by design.

Scientific Approach and Accomplishments

We seek to create optical and biologically reactive polymers for application in optoelectronics and regenerative medicine (i.e. implantable sensors). Ultimately we aim to create polymer libraries in vivo and display them in a format that enables facile selection of bio- (shown here) and photo-reactive polymers (shown here in nonlibrary

format), out of a mixture of millions of different polymers. For ease in discussion our work is divided into biologically and optically active sections; however, we note that both sections of the project overlap experimentally (techniques, in vivo polymers, libraries and application of the polymers).

We first learned how to design (DNA), express (bacterial creation of the polymer), functionalize and manipulate these unusual protein materials (ELPs). Like synthetic polymers, these in vivo polymers are repeating unit of sequence that imparts the polymer with its materials properties (tensile strength, resilience, shape memory). To make bacteria reliably produce these polymers, in scalable yields for eventual industrial application, we had to carefully vary the genetic code. Next we had to develop conditions for their high yield synthesis, purification, facile characterization of their transitions (i.e. with temperature, salt, pH, etc), casting of hydrogels, and rheological characterization (Figure 2).

Once we determined that bacteria could easily create our designed polymers, we showed that both phage and yeast could “display” the polymers on their surface. Effectively we are creating the conditions that phage and yeast can have a coating of polymer on their surface, while still maintaining the DNA that encodes for that polymer within the organism. This coupling between the polymer display and DNA encoding allow us to quickly screen libraries for functional materials. We further demonstrated that we could display polymers with a previously defined function and that those polymers were active and functional when coating the phage and yeast. Next we demonstrated that we could make large and diverse libraries (10^8) of different polymers, each displayed on their individual phage or yeast vehicles. We validated this library by selection of polymers that bind integrins (receptors on the cell surface that respond to- and model-their environment) and have shown that we can select from the large libraries not only the one polymer sequence previously known to bind these integrins (RGD-like), but that we could select for polymers that showed completely novel binding motifs and that were selective for specific integrins.

For biologically active polymers our ultimate goal is to develop polymers that have a specific biological response [i.e. polymers for implantable sensors (biocompatible and electronically active) or polymers for rapid wound healing in the field (allow the recruitment, proliferation and differentiation of specific cells)]. Any type of material that is added to the body must not only be biocompatible, but must also have specific functionality, or it will be rejected. While past efforts have focused on the retooling of man-made materials, our project was focused on designing experiments that enable Nature to tell us which

of the 10^8 different polymers it most liked for a particular application. Toward an exciting and timely application of these concepts, we chose to functionally mimic the extracellular milieu, which critically determines the fate of cells. Mesenchymal stem cells (MSC, from adult fat) were interacted with the polymer libraries. Through design of a high-throughput selection process, we determined which polymers adhered to the cells and indicated ideal functionality. From a large list of polymers with this defined functionality, we chose to focus on one polymer ("Polymer 46"). When polymer-46 was deposited on a surface, we find that MSC change from naïve stem cells and quickly move toward chondrocytes (precursors for cartilage)! We showed that these cells form into spheroids, morphologically similar to early chondrocytes, which implies that polymer-46 induces differentiation of MSC without need to add the chemicals/growth factors typically required for differentiation. Finally we showed that the spheroids produced proteins and surface markers indicative of chondrocyte differentiation (production of sulfated glycosaminoglycans (GAG, dermatan, chondroitin, heparan, and keratan sulfate) and upregulation of typical chondrogenesis markers such as Collagen IIA, Aggrecan, and Sox9 (Figure 3), all items necessary to produce the compressible extracellular milieu that is necessary for cartilage function. This work has been protected with a provisional patent application and will go toward a full patent application. In addition to the papers indicated as published, we are finalizing a paper for submission to Nature Materials.

Toward the goal of improving elastin polymers to make them self assemble into defined matrices, we incorporated a computational design element to create peptide coils that pattern into specific shapes, spontaneously. To further increase their utility, we have modified ELPs together with the coils to create matrices that both spontaneously assemble, while also becoming stimuli responsive. We find that the pore size can change as a function of stimuli (much like the polymers described above). In addition to the papers indicated as published, this work is being finalized for submission to Nature Materials and Journal of the American Chemical Society.

For optoelectronically active polymers our motivation was to increase the throughput of developing polymers with defined optical outputs ("tailored emergent properties") for new energy converting and touch screen panel materials, biosensor interfaces, and smart soldiers suits, as just a few examples (here we developed the institutional knowledge and then will later apply this to high-throughput). While Nature creates materials from building blocks that are diverse it does not have building blocks for protein polymers that are optically, catalytically, nor electronically

active. To increase the diversity and functionality of our polymers, we have synthesized and optically/electronically characterized a suite of conjugated oligomers of polyphenylene vinylene (OPPV). In addition, we have created and characterized a suite of transition and lanthanide metal complexes. Excitingly, we have shown that the metal complexes can be conjugated to ELPs into defined regions of the polymer and that confinement of those complexes in the stimuli-responsive polymer lead to interesting optical behavior- suggesting that similar complexes might have applications in catalysis. In addition to optically active metal complexes, we have shown that the stimuli-responsive nature of these materials can be utilized to template metals and that the polymer critically controls the macro- and micro-structure of the resulting composite (Figure 4). Further we have demonstrated that hydrogels of OPPV-ELPs polymers can be stably created and show new emergent optical phenomena once the OPPV is embedded with the genetically encoded polymer backbone. In one polymer we have created a mechanosensor that lights-up upon application of strain-- resulting from the unique interaction of the polymer with the OPPV (Figure 5). Finally, we have begun to incorporate metal linked thiophene oligomers to ELPS (functionalized in specific regions of the polymer) and incorporated them or the unfunctionalized polymer as either the dielectric or conducting regions of transistors, toward creating fully flexible and bio-compatible and degradable electronics.

Impact on National Missions

We are creating the infrastructure to develop materials for biosensing, rapid wound-healing in the combat field, self-healing polymers for binding agents, fabrics for chemical agent remediation, smart-skin, soft electronics and mechanosensors.

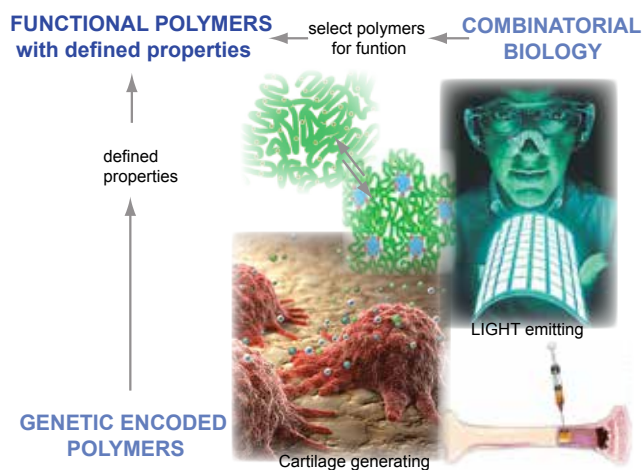

Figure 1. The genetic encoding of polymers, coupled with combinatorial biology, enables facile selection of functional polymers that are light emitting or biologically reactive.

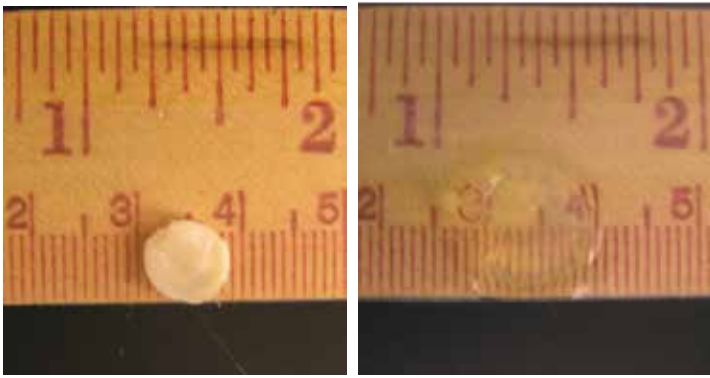

Figure 2. Elastin Like Polymers (ELPs) can be genetically engineered to have altered phase transitions with temperature (cold, right and hot, left).

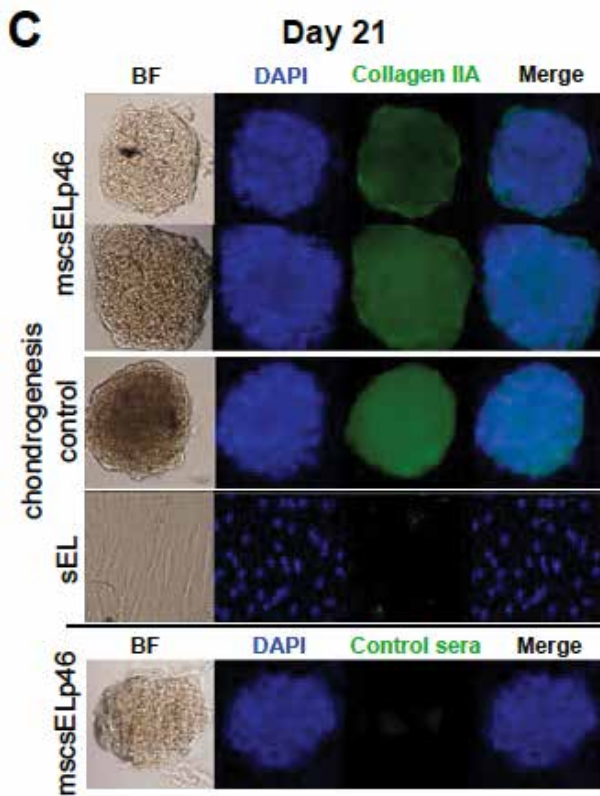

Figure 3. We showed that these cells form into spheroids, morphologically similar to early chondrocytes, which implies that polymer-46 results in differentiation of MSC without need to add the chemicals/growth factors typically required for differentiation. Finally we showed that the spheroids produced proteins and surface markers indicative of chondrocyte differentiation (production of sulfated glycosaminoglycans (GAG, dermatan, chondroitin, heparan, and keratan sulfate) and upregulation of typical chondrogenesis markers such as Collagen IIA, Aggrecan, and Sox9, all items necessary to produce the compressible extracellular milieu that is necessary for cartilage function.



Figure 4. We have shown that the stimuli-responsive nature of these materials can be utilized to template metals and that the polymer critically controls the macro and micro structure of the resulting composite.

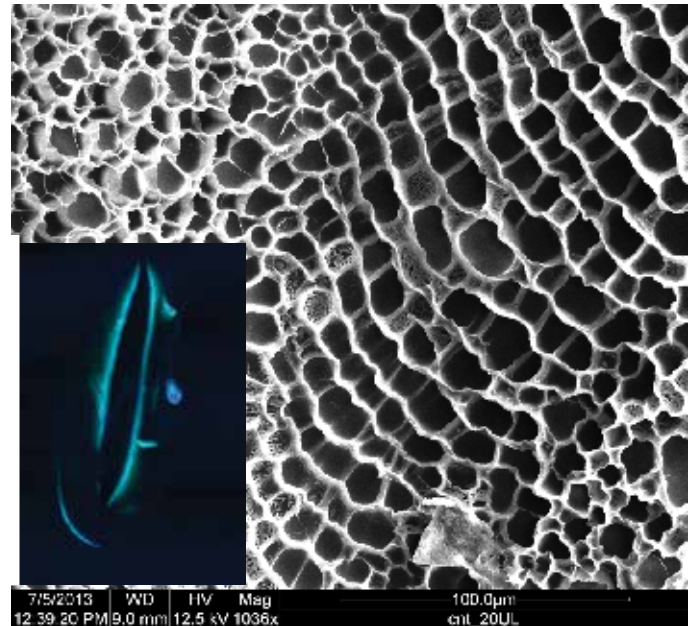

Figure 5. We have demonstrated that hydrogels of OPPV-ELPs polymers can be stably created and show new emergent optical phenomena once the OPPV is specifically embedded with the genetically encoded polymer backbone. In one specific polymer we have created a mechanosensor that lights-up upon application of strain- resulting from the unique interaction of the polymer with the OPPV.

Publications

- Balog, E. R. M., K. Ghosh, Y. I. Park, V. Hartung, P. Sista, R. C. Rocha, H. L. Wang, and J. S. Martinez. Optical properties of a pH-sensitive and thermoresponsive hydrogel made from a genetically engineered polymer and phenylene vinylene oligomer. *Journal of Physical Chemistry*.
- Cheruku, P., J. H. Huang, R. I. Iyer, K. D. Rector, J. S. Martinez, and H. L. Wang. Tyrosine-Derived Stimuli Responsive, Fluorescent Amino Acids. To appear in *Chemical Sciences*.
- D'angelo, S., J. Glanville, F. Ferrara, L. Naranjo, C. D. Gleasner, X. Shen, A. R. M. Bradbury, and C. Kiss. The antibody mining toolbox: An open source tool for the rapid analysis of antibody repertoires. 2013. *mAbs*. : 160.
- Ghosh, K., E. R. M. Balog, P. Sista, D. J. Williams, D. Kelly, J. S. Martinez, and R. C. Rocha. Temperature-dependent morphology of hybrid nanoflowers from elastin-like polypeptides. 2014. *APL Materials*. 2: 021101.
- Jha, R. K., and C. E. M. Strauss. 3D structure analysis of PAKs: A clue to the rational design for affinity reagents and blockers. 2012. *Cellular Logistics*. 2: 69.
- Park, Y. I., B. Zhang, S. Mallapragada, J. S. Martinez, Y. W. Park, and H. -L. Wang. Stimuli Responsive Poly-N-isopropylacrylamide- polyphenylene vinylene Oligomer Conjugate. 2013. *Journal of Physical Chemistry C*. 117: 7757.
- Park, Y. I., O. Postupna, A. Zhugayevych, H. Shin, Y. S. Park, B. Kim, H. J. Yen, P. Cheruku, J. S. Martinez, J. W. Park, S. Tretiak, and H. L. Wang. A New pH Sensitive Fluorescent and White Emission Material through Controlled Intermolecular Charge Transfer. To appear in *Chemical Sciences*.
- Sista, P., K. Ghosh, J. S. Martinez, and R. C. Rocha. Polythiophenes in biological applications. 2014. *Journal of Nanoscience and Nanotechnology*. 14: 250.
- Sista, P., K. Ghosh, J. S. Martinez, and R. C. Rocha. Metallo-biopolymers: conjugation strategies and applications. 2014. *Polymers Review*. 54: 627.
- Wang, H. -L., Y. I. Park, C. -Y. Kuo, S. Tretiak, J. S. Martinez, A. Zhugayevych, and O. Postupna. Tailored electronic structure and optical properties of conjugated systems through aggregates and dipole-dipole interactions. 2013. *CAS Applied Materials and Interfaces*. 5: 4685.

Modern Challenges in Actinide Science

Albert Migliori
20120167DR

Abstract

The Postdoctoral and Student Fellows Program for Research in Actinide Science supported the LANL Plutonium Science and Research Strategy and the broader Laboratory mission areas that require knowledge of actinides and other radioactive materials. The aim was to advance actinide chemistry, actinide materials science, and actinide theory for nuclear weapons, energy security, threat reduction, nuclear safeguards, non-proliferation, nuclear forensics, and environmental restoration and to support, attract, and retain a future generation of actinide scientists and engineers by providing funding for targeted sub-projects at the forefront of actinide science today, in alignment with the NNSA's designation of LANL as a plutonium center of excellence. The mechanisms used were structured around a multi-year, broad-based postdoctoral fellows project. An Internal Advisory Committee with membership qualifications to encompass the future stockpile stewardship, safety, forensics, threat reduction, and energy missions of actinide science at LANL selected Fellows and projects. Postdoctoral fellows were funded primarily half-time, must have been approved by the LANL Postdoctoral program, and must have chosen a project that connects directly with actinide science or the goals of the Laboratory Plutonium Science and Research Strategy. The program was administered by the G. T. Seaborg Institute for Transactinium Science. It is important to note that it is rare that a postdoc stays in this project for two years because postdocs are frequently converted to LANL staff or find jobs in other labs or academia, and these events are unpredictable. Over 80% of all new hires of Ph. D. scientists and engineers at Los Alamos in recent years were postdoctoral conversions.

Background and Research Objectives

Seaborg Postdoctoral and Student Fellows performed research that supports new actinide science in physics, chemistry, metallurgy, detection, technique development, theory, and modeling. The Fellows were selected in a highly competitive process. Postdoctoral Fellows

were supported half time by the institute and half time by their mentors. Student Fellows were generally supported full time over the summer, but in a few cases, students were supported for a longer time period to conduct thesis work at the Laboratory. In this way, a modest \$1.3M program, with funding leveraged from Global Security, the Science Campaigns, and DNDO supports roughly 16 half-time postdoctoral fellows, 18 student fellows, and oversight and management of the program.

The LDRD funding for Seaborg-Institute-selected Postdoctoral Fellows began in 2004 with an initial \$130K investment. Since then the program has sponsored the research of 79 Fellows. Three of the Seaborg Institute Fellows subsequently were selected to receive Reines Fellowships, five became Director's Postdoctoral Fellows, and one received a National Security Fellowship. We feel this provides an indication of the excellence of the candidate pool. To date sixteen of the Seaborg-sponsored fellows have joined the Laboratory as scientists and several have taken positions at other national laboratories. The fellows have given 75 lectures in the Seaborg Institute Actinide Seminar Series. Several of the fellow's research papers have been featured on the covers of major journals including Nature Chemistry, Nature Materials, and Inorganic Chemistry. The partial list of 79 papers submitted, accepted or published resulting from the fellow's projects over the last three years represent a truly exceptional number considering the difficulties in working with actinides. These publications are listed in the appendix.

The study of the chemical, physical, and nuclear properties of the elements ranging from thorium through lawrencium (the actinides) and rutherfordium through the most recently discovered element with atomic number 118 (the transactinides) comprises transactinium science. Mostly synthetic, and all radioactive, their study is particularly challenging. Special facilities, instrumen-

tation, and training, existing in only a few locations worldwide, are required for safe and secure handling of these elements, distinguishing transactinium science from most other research.

Of the transactinium elements, uranium and plutonium are especially important to Los Alamos missions. Fundamental actinide science has provided the technical basis for process and separations chemistry, metallurgy, characterization, and detection related to the national security mission of the Laboratory. Recognizing this, the Laboratory has implemented a Plutonium Science and Research Strategy.

Seaborg Institute Postdoctoral Fellows and their mentors developed projects consistent with the institutional goals for actinide science, mostly described by the Plutonium Science and Research Strategy. The basic science themes from the Plutonium Science and Research Strategy and (in short) include:

- Electronic structure of plutonium and other actinides
- Phase stability and thermodynamic properties
- Dynamic behavior of plutonium
- Plutonium surface and interface reactions
- Advanced chemical separations of plutonium
- Advanced nuclear energy systems
- Detection, measurement, and analysis of plutonium, uranium and neptunium
- Environmental behavior of plutonium and other actinides

Scientific Approach and Accomplishments

Educational opportunities are needed at many levels, not just through formal student courses. Accordingly, we maintained a combination of colloquia, seminars, workshops, short courses, to focus and guide early-career actinide scientists via the Seaborg Institute.

Solicitation Process for Seaborg Institute Postdoctoral Fellows

The project is publicized at each lecture of the Seaborg Institute Lecture Series, by the call for applications issued several times a year to all the technical divisions of the Laboratory, by invited talks given at universities, and at seminars given by the Seaborg Institute executive team. The Plutonium Futures – The Science conference series, an important Seaborg organizational function, highlights the Seaborg Institute and its postdoctoral fellows as essential contributors to actinide science at Los Alamos and presents the Seaborg Institute Postdoctoral Program to actinide scientists worldwide. We actively solicited applications from Los Alamos technical divisions typically under-rep-

resented in the Seaborg Institute postdoctoral population such as global security, non-proliferation and biology. This has attracted substantial and enduring follow-on funding.

Application Process and Eligibility for Actinide Science Postdocs

The successful candidates were approved for division funding by the Los Alamos postdoctoral program (<http://int.lanl.gov/science/postdocs/>), and had a clearly defined research proposal that supports new actinide science at the single investigator or small-team level, described in a one-page abstract, written by the student and mentor. This abstract and a complete LANL postdoctoral application package constituted the Postdoctoral Fellows Program for Research of Actinide Science application. A call for applications was made at least twice a year. Both U.S. and non-U.S. citizens were eligible to apply. The appointments were for two years, with the option of a one-year renewal that must have been requested in writing for consideration by the selection committee.

Selection Process

A selection committee judged applications based on academic excellence, relevance of the candidate's research to fundamental actinide science, and overall balance of the program census with the LANL Plutonium Science and Research Strategy, and the science and technology goals outlined here. The Seaborg Institute management team chose the selection committee. Written criteria for selections was used, largely the same as those used in the LDRD process. Ranks for each candidate were assembled, recorded, and the final decisions made by the Seaborg Management team where overall balance in subject areas was considered for highly-ranked applicants.

Reporting Requirements

The Fellows were required to participate in the Seaborg Institute seminar series, and gave at least one scientific lecture on actinide science in this series. Publications resulting from Seaborg sponsorship acknowledged financial support from the Institute, and the Fellow provided a list of publications and presentations resulting from Seaborg support on an annual basis. Upon completion of the appointment, the Fellow was required to submit a short report on research progress, publications, presentations, and future employment status.

Research Focus Areas

Broadly defined, the Seaborg Fellows program supports core mission science in nuclear weapons, energy security, nuclear safeguards, nonproliferation, environmental restoration, and nuclear waste management. As such, the Seaborg Fellows program supported research in the areas that are deemed strategic for the Laboratory, that sup-

ported the new “plutonium center of excellence” designation for Los Alamos, and that reflected the changing grand challenges of the LDRD process.

LDRD Project Management. Regular communication is crucial to the success of any scientific enterprise. As such, the Seaborg management team met weekly to share new results, engage in interpretation of data, keep track of budgets, and discuss any other items that affect the LDRD effort. Director Albert Migliori (NHMFL, 0.10 FTE) conducted the overall management of the program and was responsible for administrative and reporting requirements. Deputy Director Gordon D. Jarvinen (ADPSM, 0.1 FTE) shared management duties and oversight of the Seaborg Fellows Monthly seminar program, poster sessions, program reviews, selection of candidates, and strategic planning.

Timetable. The current postdoctoral fellows program had roughly 16 half-time appointments. In any year, we expected approximately half of these to move on to internal or external permanent positions, making room for an additional eight new positions. Two calls for applications were timed to coincide roughly with two of the quarterly calls and meetings of the Laboratory Postdoctoral Committee. Applications were accepted between calls on a case-by-case basis and must first be approved by the Laboratory Postdoctoral Program process. For very strong candidate applications received between regular calls, the selection committee met to consider Seaborg Institute funding as a recruitment tool.

Actinide Science Summer School. The Actinide Science Summer School offered a combination of actinide science lectures and hands-on laboratory research that in some cases was part of Ph.D. theses. This project leveraged funding from the Domestic Nuclear Detection Office (DNDO) and LDRD. Student support through the LDRD program is essential for continuity, as funding from proposal calls such as that issued by the DNDO tend not to be long-term programs.

Technical Results

Understanding the first-principles behavior of plutonium and other actinides requires a diverse and deep set of scientific skills, along with complex experimental tools and the most powerful computers in the world. Improving our fundamental understanding of plutonium requires that we work closely at the frontiers of actinide science with the academic and international research communities. For us to succeed, it is essential that we continue to attract and retain the best and the brightest of the next generation of scientists and engineers. We expected this project to:

- Foster sustained excellence and enhanced external visibility in actinide science at Los Alamos National Laboratory as measured by invited talks, peer-reviewed publications, and Seaborg Institute Postdoctoral Fellows participation in workshops and conferences.
- Attract and retain a future generation of actinide scientists through student and postdoctoral fellows, measured by total program participation and conversions of students to postdoctoral positions, and postdoctoral fellows to LANL staff.
- Maintain a national resource for the education of present and future actinide scientists and engineers in actinide science, as measured by Seaborg-sponsored educational functions.
- Establish an intellectual community to facilitate the nucleation of ideas to solve timely and important technological problems with actinide elements, as measured by participation of Seaborg-sponsored fellows and mentors in actinide research workshops and proposals.
- Support the LANL Plutonium Science and Research Strategy, an explicit requirement of Performance-Based Initiative 18.2 of the LANL contract.

We work towards these goals through LDRD-supported postdoctoral research and development. Because of the diversity of R&D conducted by Seaborg Postdoctoral Fellows, the (attached) publication record is the best measure of success. We do note here a few brief highlights.

- Used state of the art electronic structure methods to investigate the ^{229}mTh nuclear transition.
- Studies of $\text{FSn}(\text{CH}_3)_3$, uranium(V) and uranium(IV) halide (I, Br, Cl) compounds, as well as thorium(IV) chlorides by nuclear magnetic resonance, electrochemistry, UV-Vis, and crystal structure diffractometry.
- Development of multiple, complementary x-ray fluorescence spectrometry (XRF) based analytical methods for characterization of actinides in complex matrices, with a focus on uranium and plutonium using micro-XRF, confocal 3D XRF, and hiRX.
- Evaluated orbital mixing and electronic structure in inorganic and bioinorganic systems for actinide/lanthanide separations using ligand K-edge X-ray absorption spectroscopy (XAS) and time-dependent density functional theory (TDDFT).
- Research of fundamental chemical properties of ^{225}Ac and its daughter nuclide, ^{213}Bi , alpha-emitting iso-

topes that are currently under clinical investigation for use in cancer therapy.

- Production of uranium and thorium nitrides through the combustion of metal complexes that feature high-nitrogen ligands.
- Analytical studies of fundamental transuranic coordination chemistry via isolation of complexes ligated to either chelating, mixed O- and N-donor atoms or soft-donor atoms (e.g., S, Se).
- Optimization of radioisotope identification algorithms with the creation of traceable and reproducible benchmark gamma-ray spectra for different types of detectors, sources, and shielding configurations.
- Microanalytical investigations of debris from two historic nuclear tests to understand the range and types of compositional variation present within select glassy fallout debris samples using in situ microanalytical techniques – electron microscopy, autoradiography, and secondary ion mass spectrometry (SIMS).
- Demonstrate nuclear quadrupole resonance (NQR) as a tool for special nuclear materials and material analysis, e.g. determining enrichment levels and forensic history.
- Design and synthesis of novel heterocyclic dithiophosphinic acids (Ar₂PS₂H) for the separation of minor actinides (MA) from lanthanides (Ln).
- Investigated the performance of screened hybrid density functional theory on the actinide oxide (AnO and AnO₂), actinide nitride (AnN and AnN₂) and actinide carbide (AnC and AnC₂) materials (An=U, Np and Pu)
- Exploit recent advances in microspectroscopies and spectrometries to develop more accurate and robust analytical methods, and then apply these methods to characterize a range of synthetic and radiologic nuclear samples allowing identification of chemical, structural and molecular characteristics of particulate materials.
- Modeling mechanical response and texture evolution of α -uranium as a function of strain rate and temperature using polycrystal plasticity.
- Development of a polycrystal plasticity model for predicting mechanical response and texture evolution during strain-path changes in beryllium.
- Spectral interpretation of Pu materials consistent with Pu solid state allotropes, Pu chalcogenides, and Pu pnictides, and measurement of the photoemission

spectra for actinide carbides, nitrides, and oxides related to the development of improved hybrid functional theory with predictive capability.

- Address fundamental problems in p-, d-, and f-block chemistry by exploring theories of bonding.
- Development of an ultra-high precision measurement scheme for Resonant Ultrasound Spectroscopy currently actively used in actinide research.

Impact on National Missions

With nuclear weapons technology continuing to play a central role in defense policy for the foreseeable future, knowledge and expertise in the production, processing, purification, characterization, analysis, and disposal of actinide elements is essential to U.S. national security. Recognizing the environmentally destructive effects of burning fossil fuels, it is virtually certain that nuclear energy will assume a greater role in the nation's energy policy in the future.

A new challenge is to reduce the size of nuclear arsenals while ensuring that nuclear weapons are safe and reliable without nuclear testing, while dealing with excess uranium and plutonium recovered from these warheads.

Deterrence is shifting away from large numbers of deployed nuclear weapons toward an agile and confident capability to support deterrence, with actinide and plutonium science at its core, requiring a broad understanding of plutonium and uranium metallurgy, chemistry, and physics, strategies for securing these materials against diversion or theft, new applications as fuel in nuclear reactors, and methods for geologic or other disposition.

Of real concern is the recognition that the academic degree programs and research opportunities in actinide science are small and decreasing so that the field of actinide science is becoming subcritical, so to speak, at a time when it is crucial for our nation's defense and energy security. The national laboratories must take a lead role in maintaining core capabilities in actinide science, helping to train present and future generations.

Publications

Ashley, K. R., S. M. Bowen, J. W. Oldham, A. C. Olson, S. A. Kozimor, and A. R. Schake. Quantifying abundances of long-lived ¹⁵⁵Eu and ¹⁵¹Sm fission products using gamma- and liquid scintillation counting spectroscopies. *Analytical Chemistry*.

Barker, B. J., J. Berg, and M. P. Wilkerson. Excitation spectroscopy of a neptunyl ion doped into a uranyl lattice. *Journal of Solid State Chemistry*.

- Beaux, M. F., J. J. Joyce, T. Durakiewicz, K. S. Graham, E. D. Bauer, J. N. Mitchell, P. H. Tobash, and S. Richmond. Electronic structure, localization, and 5f occupancy in Pu materials. 2012. MRS Proceedings. 1444 (2012): 123.
- Beaux, M. F., J. J. Joyce, T. Durakiewicz, K. S. Graham, E. D. Bauer, J. N. Mitchell, P. H. Tobash, and S. Richmond. Electronic structure, localization and 5f occupancy in Pu materials. 2012. Materials Research Society Symposium Proceedings. 1444: 123.
- Bejger, C., Y. H. Tian, B. J. Barker, K. S. Boland, B. L. Scott, E. R. Batista, S. A. Kozimor, and J. L. Sessler. Synthesis and characterization of a tetrathiafulvalene-salphen actinide complex. 2013. Dalton Transactions. 42: 6716.
- Bejger, C., Y. Tian, B. J. Barker, E. R. Batista, K. S. Boland, S. A. Kozimor, B. L. Scott, J. L. Sessler, and M. P. Wilkerson. Synthesis and characterization of a tetrathiafulvalene-salphen actinide complex. 2013. Dalton Transactions. 42 (9): 6716.
- Boland, K., S. Conradson, A. Costello, A. Gaunt, S. Kozimor, I. May, S. Reilly, and D. Schnaars. Stabilising pentavalent actinides-visible-near infrared and X-ray absorption spectroscopic studies of the utility of the $[(\text{Np3W4O15})(\text{H}_2\text{O})(3)(\text{MW9O33})(3)](18-)(\text{M} = \text{Sb, Bi})$ structural type. 2012. DALTON TRANSACTIONS. 41 (7): 2003.
- Chen, X. Y., G. S. Goff, B. L. Scott, and W. Runde. Comparison of structural variations of Ln(III) compounds with (pyrazol-1-yl)acetic acid. 2014. Polyhedron. 68: 80.
- Chen, X., G. S. Goff, M. Quiroz-Guzman, D. P. Fagnant, Jr., J. F. Brennecke, B. L. Scott, and W. Runde. Directed nucleation of monomeric and dimeric uranium(VI) complexes with a room temperature carboxyl-functionaled phosphonium ionic liquid. 2012. Chemical Communications. 49 (19): 1903.
- Chen, X., G. S. Goff, W. C. Ewing, B. L. Scott, and W. Runde. Solid-state and solution-state coordination chemistry of Lanthanide(III) complexes with alpha-hydroxyisobutyric acid. 2013. Inorganic Chemistry. 52 (6): 3217.
- Chen, X., G. S. Goff, W. C. Ewing, B. L. Scott, and W. Runde. Solid-state and solution-state coordination chemistry of Lanthanide(III) complexes with alpha-hydroxyisobutyric acid. 2012. Inorganic Chemistry. 51: 13254.
- Coleman, M. E., E. M. Bond, W. A. Moody, and L. Tandon. The analysis of uranium-232: comparison of radiochemical techniques and an improved method by alpha spectrometry. 2013. JOURNAL OF RADIOANALYTICAL AND NUCLEAR CHEMISTRY. 296 (1): 483.
- Daly, S., J. Keith, E. Batista, K. Boland, D. Clark, S. Kozimor, and R. Martin. Sulfur K-edge X-ray absorption spectroscopy and time-dependent density functional theory of dithiophosphinate extractants: Minor actinide selectivity and electronic structure correlations. 2012. Journal of the American Chemical Society. 134 (35): 14408.
- Daly, S., J. Keith, E. Batista, K. Boland, S. Kozimor, R. Martin, and B. Scott. Probing Ni[S2PR2](2) Electronic Structure to Generate Insight Relevant to Minor Actinide Extraction Chemistry. 2012. INORGANIC CHEMISTRY. 51 (14): 7551.
- Daly, S., J. Klaehn, K. Boland, S. Kozimor, M. MacInnes, D. Peterman, and B. Scott. NMR spectroscopy and structural characterization of dithiophosphinate ligands relevant to minor actinide extraction processes. 2012. Dalton Transactions. 41 (7): 2163.
- Ellis, J. K., R. L. Martin, and G. E. Sucseria. On pair functions for strong correlations. 2013. Journal of Chemical Theory and Computation. 9 (7): 2857.
- Ellis, J. K., X. D. Wen, and R. L. Martin. Investigation of thorium salts as candidate materials for direct observation of the Th-229m nuclear transition. 2014. Inorganic Chemistry. 53 (13): 6769.
- Gianetti, T. L., G. Nocton, S. G. Minasian, N. C. Tomson, A. L. D. Kilcoyne, S. A. Kozimor, D. K. Shuh, T. Tyliszczak, R. G. Bergman, and J. Arnold. Diniobium inverted sandwich complexes with $\mu\text{-}\eta^6\text{:}\eta^6\text{-arene}$ ligands: synthesis, kinetics of formation, and electronic structure. 2012. Journal of the American Chemical Society. 135 (8): 3224.
- Harrison, N., and A. Shekhter. A quantum oscillation signatures of nodal spin-orbit coupling in underdoped bilayer high Tc cuprates. Physical Review Letters.
- He, H. M., D. A. Andersson, D. D. Allred, and K. D. Rector. Determination of the insulation gap of uranium oxides by spectroscopic ellipsometry and Density Functional Theory. 2013. The Journal of Physical Chemistry. 117 (32): 16540.
- He, H., P. Wang, D. D. Allred, J. Majewski, M. P. Wilkerson, and K. D. Rector. Characterization of chemical speciation in ultra thin uranium oxide layered films. 2012. Analytical Chemistry. 84: 10380.
- He, H., P. Wang, D. D. Allred, M. P. Wilkerson, J. Majewski, and K. D. Rector. Characterization of chemical speciation in ultra thin uranium oxide films. 2012. Analytical Chemistry. 84 (23): 10380.
- Jilek, R., L. Spencer, R. Lewis, B. Scott, T. Hayton, and J. Boncella. A Direct Route to Bis(imido)uranium(V) Halides via Metathesis of Uranium Tetrachloride. 2012. Journal of the American Chemical Society. 134 (24): 9876.

- Knezevic, M., I. J. Beyerlein, D. W. Brown, T. A. Sisneros, and C. N. Tome. A polycrystal plasticity model for predicting mechanical response and texture evolution during strain-path changes: Application to beryllium. 2013. *INTERNATIONAL JOURNAL OF PLASTICITY*. 49: 185.
- Knezevic, M., I. J. Beyerlein, T. Nizolek, N. A. Mara, and T. M. Pollock. Anomalous basal slip activity in zirconium under high-strain deformation. 2013. *Materials Research Letters*. 1 (3): 133.
- Knezevic, M., J. S. Carpenter, and R. J. McCabe. Deformation behavior of the cobalt-based superalloy Haynes 25: Experimental characterization and crystal plasticity modeling. 2014. *Acta Materialia*. 63 (15 Jan): 162.
- Knezevic, M., R. A. Lebensohn, O. Cazacu, B. Revil-Baudard, G. Proust, S. Vogel, and M. E. Nixon. Modeling bending of α -titanium with embedded crystal plasticity and analytical yield surface formulations in implicit finite elements. 2013. *Materials Science and Engineering A*. 564 (1 March): 116.
- Knezevic, M., R. J. McCabe, C. N. Tome, R. A. Lebensohn, S. R. Chen, C. M. Cady, G. T. Gray, and B. Mihaila. Modeling mechanical response and texture evolution of α -uranium as a function of strain rate and temperature using polycrystal plasticity. 2013. *INTERNATIONAL JOURNAL OF PLASTICITY*. 43: 70.
- Knezevic, M., R. J. McCabe, R. A. Lebensohn, C. N. Tome, C. Liu, M. L. Lovato, and B. Mihaila. Integration of self-consistent polycrystal plasticity with dislocation density based hardening laws within an implicit finite element framework: Application to low-symmetry metals. 2013. *JOURNAL OF THE MECHANICS AND PHYSICS OF SOLIDS*. 61 (10): 2034.
- Knezevic, M., R. J. McCabe, R. A. Lebensohn, C. N. Tome, and B. Mihaila. Modeling mechanical response and texture evolution of α -uranium as a function of strain rate and temperature using polycrystal plasticity. 2013. *International Journal of Plasticity*. 43 (April): 70.
- Koutroulakis, G., H. Chudo, H. Yasuoka, P. H. Tobash, H. N. Mitchell, E. D. Bauer, and J. D. Thompson. Microscopic properties of the heavy-fermion superconductor PuCoIn₅: explored by nuclear quadrupole resonance. 2014. *New Journal of Physics*. 16: 053019.
- Koutroulakis, G., H. Chudo, H. Yasuoka, P. H. Tobash, J. N. Mitchell, E. D. Bauer, and J. D. Thompson. Weak Itinerant Antiferromagnetism in PuIn₃ Explored Using In-115 Nuclear Quadrupole Resonance. 2014. *Journal of Physics - Condensed Matter*. 26 (3): 036001.
- McCleskey, T. M., E. Bauer, Q. X. Jia, A. K. Burrell, B. L. Scott, S. D. Conradson, A. Mueller, L. Roy, X. D. Wen, G. E. Scuseria, and R. L. Martin. Optical band gap of NpO₂ and PuO₂ from optical absorbance of epitaxial films. 2013. *JOURNAL OF APPLIED PHYSICS*. 113 (1): 013515.
- Mihaila, B., M. Knezevic, and A. Cardenas. Three orders of magnitude improved efficiency with high-performance spectral crystal plasticity on GPU platforms. 2014. *International Journal for Numerical Methods in Engineering*. 97 (11): 785.
- Minasian, S. G., E. R. Batista, K. S. Boland, J. A. Bradley, D. L. Clark, S. D. Conradson, S. R. Daly, J. M. Keith, S. A. Kozimor, W. W. Lukens, R. L. Martin, G. T. Seidler, D. K. Shuh, T. Tylliszczak, G. L. Wagner, and P. Yang. Covalency in metal-oxygen multiple bonds evaluated using oxygen K-edge spectroscopy and electronic structure theory. 2012. *Journal of the American Chemical Society*. 135 (5): 1864.
- Minasian, S. G., J. M. Keith, E. R. Batista, D. L. Clark, S. A. Kozimor, R. L. Martin, and D. K. Shuh. The importance of φ -orbital mixing in thorocene and uranocene determined from carbon K-edge X-Ray absorption spectroscopy and time-dependent density functional theory. *Angewandte Chemie*.
- Minasian, S. G., J. M. Keith, E. R. Batista, K. S. Boland, D. L. Clark, S. A. Kozimor, R. L. Martin, D. K. Shuh, and T. Tylliszczak. New evidence for 5f covalency in actinocenes determined from carbon K-edge XAS and electronic structure theory. 2014. *Chemical Science*. 5: 351.
- Minasian, S. G., J. M. Keith, E. R. Batista, K. S. Boland, D. L. Clark, S. A. Kozimor, R. L. Martin, D. K. Shuh, and T. Tylliszczak. New evidence for 5f covalency in actinocenes determined from carbon K-edge XAS and electronic structure theory. 2014. *Chemical Science*. 5 (1): 341.
- Minasian, S. G., J. M. Keith, E. R. Batista, K. S. Boland, J. A. Bradley, S. R. Daly, W. W. Lukens, J. Nordlund, G. T. Seidler, D. Sokaras, G. L. Wagner, T. C. Weng, P. Yang, S. A. Kozimor, R. L. Martin, D. K. Shuh, and T. Tylliszczak. Orbital mixing in metal-oxygen multiple bonds evaluated using oxygen K-edge spectroscopy and DFT. *Nature Chemistry*.
- Minasian, S. G., J. M. Keith, E. R. Batista, S. A. Kozimor, R. L. Martin, D. K. Shuh, T. Tylliszczak, and L. J. Vernon. Carbon K-Edge X-ray absorption spectroscopy and time-dependent density functional theory examination of metal-carbon bonding in metallocene dichlorides. 2013. *Journal of the American Chemical Society*. 135 (39): 14731.
- Minasian, S., J. Keith, E. Batista, K. Boland, D. Clark, S. Conradson, S. Kozimor, R. Martin, D. Schwarz, D. Shuh, G. Wagner, M. Wilkerson, L. Wolfsberg, and P. Yang. Determining relative f and d orbital contributions to M-Cl covalency in MCl₆²⁻ (M = Ti,

- Zr, Hf, U) and UOCl_5 using Cl K-edge X-ray absorption spectroscopy and time-dependent density functional theory. 2012. *Journal of the American Chemical Society*. 134 (12): 5586.
- Minasian, S., K. Boland, R. Feller, A. Gaunt, S. Kozimor, I. May, S. Reilly, B. Scott, and D. Shuh. Synthesis and Structure of $(\text{Ph}_4\text{P})(2)\text{MCl}_6$ (M = Ti, Zr, Hf, Th, U, Np, Pu). 2012. *INORGANIC CHEMISTRY*. 51 (10): 5728.
- Modic, K. A., T. E. Smidt, I. Kimchi, N. P. Breznay, A. Biffin, S. Choi, R. D. Johnson, R. Coldea, P. Watkins-Curry, G. T. McCandless, F. Gandara, Z. Islam, A. Vishwanath, J. Y. Chen, A. Shekhter, R. D. McDonald, and J. G. Analytis. Realization of a three-dimensional spin-anisotropic harmonic honeycomb iridate. 2014. *Nature Communications*. 5: 4203.
- Monreal, M. J., R. K. Thomson, T. Cantat, N. E. Travia, B. L. Scott, and J. L. Kiplinger. $\text{U}(\text{I}4(1,4\text{-dioxane})_2)$, $[\text{UCl}_4(1,4\text{-dioxane})]_2$, and $\text{U}(\text{I}3(1,4\text{-dioxane})_{1.5})$: stable and versatile starting materials for low- and high-valent uranium chemistry. 2012. *Organometallics*. 30 (7): 2031.
- Monreal, M. J., R. K. Thomson, T. Cantat, N. E. Travia, B. L. Scott, and J. L. Kiplinger. $\text{U}(\text{I}4(1,4\text{-dioxane})_2)$, $[\text{UCl}_4(1,4\text{-dioxane})]_2$, and $\text{U}(\text{I}3(1,4\text{-dioxane})_{1.5})$: Stable and Versatile Starting Materials for Low- and High-Valent Uranium Chemistry. 2011. *ORGANOMETALLICS*. 30 (7): 2031.
- Olson, A. C., J. M. Keith, E. M. Batista, K. S. Boland, S. R. Daly, S. A. Kozimor, M. M. MacInnes, R. L. Martin, and B. L. Scott. Using solution- and solid-state S K-edge X-ray absorption spectroscopy with Density Functional Theory to evaluate M-S bonding for MS_4 . (M = Cr, Mo, W) dianions. *Dalton Transactions*.
- Park, W. K., P. H. Tobash, F. Ronning, E. D. Bauer, J. L. Sarrao, J. D. Thompson, and L. H. Greene. Observation of the Hybridization Gap and Fano Resonance in the Kondo Lattice URu_2Si_2 . 2012. *Physical Review Letters*. 108 (24): 246403 (5 pp.).
- Porterfield, D., M. Coleman, S. Myers, D. Decker, P. Martinez, and L. Tandon. Gamma spectrometry analysis of fission products in Japan soils. 2012. Los Alamos National Laboratory LA-CP-12-00419.
- Ramshaw, B. J., A. Shekhter, R. D. McDonald, J. B. Betts, J. N. Mitchell, P. H. Tobash, C. H. Mielke, E. D. Bauer, and A. Migliori. Avoided valence transition in a plutonium superconductor. *Nature Physics*.
- Rim, K. R., D. Eom, S. W. Chan, M. Flytzani-Stephanopoulos, G. W. Flynn, and E. R. Batista. Scanning tunneling microscopy and theoretical study of water adsorption on Fe_3O_4 : Implications for catalysis. 2012. *Journal of the American Chemical Society*. 134 (46): 18979.
- Romanchuk, A. Y., S. N. Kalmykov, A. V. Egorov, Y. V. Zubavichus, A. A. Shiryaev, O. N. Batuk, S. D. Conradson, D. A. Pankratov, and I. A. Presnyakov. Formation of crystalline $\text{PuO}_2 \cdot x\text{H}_2\text{O}$ nanoparticles upon sorption of $\text{Pu}(\text{V,VI})$ onto hematite. 2013. *Geochimica et Cosmochimica Acta*. 121: 29.
- Shekhter, A., B. J. Ramshaw, R. Liang, W. N. Hardy, D. A. Bonn, F. F. Balakirev, R. D. McDonald, J. B. Betts, S. C. Riggs, and A. Migliori. Bounding the pseudogap with a line of phase transitions in $\text{YBa}_2\text{Cu}_3\text{O}_{6+\delta}$. 2013. *Nature*. 498: 75.
- Spencer, L. P., S. G. Minasian, R. E. Jilek, E. R. Batista, K. S. Boland, J. M. Boncella, S. D. Conradson, D. L. Clark, R. L. Gdula, T. W. Hayton, S. A. Kozimor, R. L. Martin, M. A. McInnes, A. C. Olson, B. L. Scott, D. K. Shuh, and P. Yang. Tetrahalide complexes of the $[\text{U}(\text{NR})_2]^{2+}$ ion: synthesis, theory, and Cl K-edge X-ray absorption spectroscopy. 2013. *Journal of the American Chemical Society*. 135 (6): 2279.
- Stanley, F. E., K. J. Spencer, D. S. Schwartz, M. G. Watrous, and J. E. Delmore. Investigating enhanced thorium ionization in TIMS using Re/Pt porous ion emitters. 2014. *Journal of Radioanalytical and Nuclear Chemistry*. 299 (3): 1447.
- Tamasi, A. L., K. S. Boland, S. D. Conradson, K. Czerwinski, J. K. Ellis, S. A. Kozimor, R. L. Martin, A. L. Pugmire, D. Reilly, B. L. Scott, A. D. Sutton, G. L. Wagner, J. R. Walensky, and M. P. Wilkerson. Transformations in U_3O_8 materials following controlled exposure to temperature and humidity. *Inorganic Chemistry*.
- Teng, B. T., F. M. Wu, W. X. Huang, X. D. Wen, L. H. Zhao, and J. F. Luo. A DFT study of the structures of aux clusters on a $\text{CeO}_2(\text{III})$ surface. 2012. *A European Journal of Chemical Physics and Physical Chemistry*. 13 (5): 1261.
- Tobash, P., F. Ronning, J. D. Thompson, B. L. Scott, P. J. Moll, B. Batlogg, and E. D. Bauer. Single crystal study of the heavy-fermion antiferromagnet CePt_2In_7 . 2012. *Journal of Physics Condensed Matter*. 24 (1): 015601.
- Travia, N. E., M. J. Monreal, B. L. Scott, and J. L. Kiplinger. Thorium-mediated ring-opening of tetrahydrofuran and the development of a new starting material for thorium chemistry: preparation, crystal structure, and chemistry of $\text{Th}(\text{I}4(\text{DME})_4)$. 2012. *Dalton Transactions*. 2012 (41): 14514.
- Ueland, B. G., C. F. Miclea, Y. Kato, O. Ayala-Valenzuela, R. D. McDonald, R. Okazaki, P. H. Tobash, M. A. Torrez, F. Ronning, R. Movshovich, Z. Fisk, E. D. Bauer, I. Martin, and J. D. Thompson. Controllable chirality-induced geometrical Hall effect in a frustrated highly-correlated

- metal. 2012. *Nature Communications*. 3: 1067.
- Vasudevan, K. V., B. L. Scott, R. Marti-Arbona, and J. C. Gordon. Decamethylsamarocene-mediated reductive coupling of the (1R,2R)-N,N'-Bis(2-pyridylmethylene)cyclohexane-1,2-diamine ligand. *European Journal of Inorganic Chemistry*.
- Vasudevan, K. V., N. A. Smith, B. L. Scott, B. L. Bennett, J. C. Gordon, R. E. Meunchausen, and M. P. Hehlen. Nitrile-supported coordination polymers of Cerium(III) bromide. 2014. *European Journal of Inorganic Chemistry*. 2014 (3): 2213.
- Vasudevan, K. V., N. C. Smythe, B. L. Scott, and J. C. Gordon. Metallopolymer formation using the (1R,2R)-N,N'-bis(2-pyridylmethylene)-cyclohexane-1,2-diamine (BPID) ligand class. 2012. *Dalton Transactions*. 42 (14): 4768.
- Vasudevan, K., B. Scott, and J. Gordon. Main-group element compounds derived from the (1R,2R)-N,N'-bis(2-pyridylmethylene)cyclohexane-1,2-diamine (BPID) ligand. 2012. *MAIN GROUP CHEMISTRY*. 11 (1, SI): 45.
- Vasudevan, K., N. Smith, B. Scott, B. Bennett, R. Muenchausen, and J. Gordon. Ionic liquid mediated routes to polydentate oxygen-donor adducts of cerium(III) bromide. 2012. *Dalton Transactions*. 41 (7): 1924.
- Wang, S. W., M. Tang, L. L. Zhang, G. L. Xiao, K. S. Brinkman, and F. L. Chen. Irradiation effect on the structure change for Sr₂Fe_{1.5}Mo_{0.5}O_{6-δ} perovskite ceramic. 2013. *JOURNAL OF ALLOYS AND COMPOUNDS*. 578: 170.
- Wen, X. D., M. W. Loble, E. R. Batista, E. Bauer, K. S. Boland, A. K. Burrell, S. D. Conradson, S. R. Daly, S. A. Kozimor, S. G. Minasian, R. L. Martin, T. M. McCleskey, B. L. Scott, D. K. Shuh, and T. Tylliszczak. Electronic structure and O K-edge XAS spectroscopy of U₃O₈. 2014. *Journal of Electron Spectroscopy and Related Phenomena*. 194 (SI): 81.
- Wen, X. D., R. Hoffmann, and N. W. Ashcroft. Two-dimensional CdSe nanosheets and their interaction with stabilizing ligands. 2012. *Advanced Materials*. 25 (2): 261.
- Wen, X. D., R. L. Martin, G. E. Scuseria, S. P. Rudin, E. R. Batista, and A. K. Burrell. Screened hybrid and DFT plus U studies of the structural, electronic, and optical properties of U₃O₈. 2013. *JOURNAL OF PHYSICS-CONDENSED MATTER*. 25 (2): 025501.
- Wen, X. D., R. L. Martin, L. E. Roy, G. E. Scuseria, S. P. Rudin, E. R. Batista, T. M. McCleskey, B. L. Scott, E. Bauer, J. J. Joyce, and T. Durakiewicz. Effect of spin-orbit coupling on actinide dioxides, AnO₂ (An=Th, Pa, U, Np, Pu and Am): A screened hybrid density functional study. 2012. *Journal of Chemical Physics*. 137 (15): 154707.
- Wen, X. D., R. L. Martin, T. M. Henderson, and G. E. Scuseria. Density functional theory studies of the electronic structure of solid state actinide oxides. 2013. *Chemical Review*. 113 (2): 1063.
- Wen, X. D., S. P. Rudin, E. R. Batista, D. L. Clark, G. E. Scuseria, and R. L. Martin. Rotational rehybridization and the high temperature phase of UC₂. 2012. *Inorganic Chemistry*. 51 (23): 12650.
- Wen, X., T. Yang, R. Hoffmann, N. W. Ashcroft, R. Martin, S. Rudin, and J. Zhu. Graphene nanotubes. 2012. *ACS Nano*. 6 (8): 7142.
- Wilson, J. J., E. R. Birnbaum, E. R. Batista, R. L. Martin, and K. D. John. Synthesis and characterization of nitrogen-rich macrocyclic ligands and an investigation of their coordination chemistry with lanthanum(III). *Inorganic Chemistry*.
- Yang, Y., J. Saiers, N. Xu, S. Minasian, T. Tylliszczak, S. Kozimor, D. Shuh, and M. Barnett. Impact of natural organic matter on uranium transport through saturated geologic materials: From molecular to column scale. 2012. *Environmental Science and Technology*. 46 (11): 5931.
- Yasuoka, H., G. Koutroulakis, H. Chudo, S. Richmond, D. K. Veirs, A. I. Smith, E. D. Bauer, E. D. Thompson, G. D. Jarvinen, and D. L. Clarks. Observation of ²³⁹Pu nuclear magnetic resonance. 2012. *Science*. 336 (6083): 901.
- Zhang, S. X., R. D. McDonald, A. Shekhter, Z. X. Bi, Y. Li, Q. X. Jia, and S. T. Picraux. Magneto-resistance up to 60 Tesla in topological insulator Bi₂Te₃ thin films. 2012. *Applied Physics Letters*. 101: 202403.
- Zhao, X., Y. N. Martinez de Escobar, J. K. Ellis, R. Rutenberg, E. M. Bond, R. L. Martin, T. Bredeweg, and S. Kozimor. Observation of vacuum ultra-violet ^{229m}Th nuclear gamma-ray emission. *Physical Review Letters*.
- Zhao, Y., B. T. Teng, X. D. Wen, L. H. Zhao, and M. F. Luo. A theoretical evaluation and comparison of MxCe_{1-x}O_{2-δ} (M = Au, Pd, Pt, and Rh) catalysts. 2012. *Catalysis Communications*. 27: 63.
- Zhao, Y., B. T. Teng, X. D. Wen, L. H. Zhao, and M. F. Luo. Superoxide and peroxide species on CeO₂(111), and their oxidation roles. 2012. *Journal of Physical Chemistry*. 116: 15986.

Accelerating Materials Certification through Co-Design

Jack S. Shlachter
20120707DR

Abstract

The goal of this project was to make progress towards the grand challenge goal of predictive process-aware materials performance through a focus on “co-design.” Co-design traditionally refers to the simultaneous optimization of hardware and software in computer science; here, we broadened the definition of co-design to include the integrated coupling of multi-scale theory, computation/information science & technology techniques (including data visualization), and experiment. We proposed a series of four coupled thrusts to achieve our goal. Our plan was to i) build on past successes to pursue the co-design of micro-mechanical models to improve predictive capability in regimes of high-pressures and strain rates with a focus on Zr and Ti, ii) develop, in parallel with thrust i, a co-design framework for multi-scale models focused on radiation damage evolution, in particular creep-related phenomena, iii) utilize ion beam irradiation as a means of accelerating materials damage, including providing key data for thrust ii, and iv) explore the foundations of coherent x-ray diffractive imaging in order to translate physical observables into model inputs in support of thrusts i and ii. In this thrust structure, the project leadership’s principal responsibility was fostering integration and collaboration among these thrusts. This management plan yielded synergies not possible through a series of discrete projects.

Background and Research Objectives

This project represented a focused attempt to accelerate progress towards realizing the decadal vision shared by LANL’s materials strategy “controlled functionality” and the Laboratory’s vision for MaRIE “revolutionizing materials in extremes through a focus on the micron frontier.” A number of community workshops, including some led by LANL, have concluded that multiple simultaneous in situ measurements on real materials (i.e., those with microstructures and defects) in relevant environments coupled to directed synthesis through theory is a key strategy for realizing this vision. It is also clear that full

success in realizing this vision is a decadal (or beyond) challenge requiring experimental and theoretical capabilities not yet available. In the near term we believed a more segmented, staged approach is required for partial success. Specifically, in this project our approach was based on a series of smaller thrusts that strived to create integrated teams, including collaborative partnerships, and then further integrated these teams by exploiting technical synergies among them. We believe that these small steps have yielded tangible benefits in the near term and laid the foundation for greater progress in the longer term.

Subsection on technical impact

While the decadal vision of controlled functionality of materials in extremes is compelling, a strategic need exists to take initial, incremental steps in this direction both for the sake of the relevant science but also to add credibility to the vision. In this proposal, we proposed a series of thrusts, each of which was compelling in its own right; however, taken together, the whole was greater than the sum of its parts. In this project we pursued activities focused on the co-design of micro-mechanical models to improve the predictive capability of engineering analyses into the regimes of high-pressures and strain rates as well as irradiation extremes. The model development and co-design strategies focused on dynamic materials response are equally applicable to multi-scale models for understanding materials response in irradiation extremes. We explored necessary modifications to the theoretical and computational framework of minimal models for such problems. We utilized ion beam irradiation as a means of accelerating materials damage and providing key data for improved certification models. Similarly, we developed forward models for coherent x-ray diffraction to translate measured observables to model inputs.

Subsection on mission impact

The need to predict and control materials in extremes

spans the full range of DOE missions from weapons performance to energy security. Further, successful nuclear weapons program approaches to certification of materials performance (and the associated quantification of performance margins and uncertainty) have not e.g., been translated to nuclear energy materials certification challenges. In this project, we partnered with our colleagues at SNL and LLNL to both address specific process-aware materials performance challenges in our enduring nuclear weapons stockpile (with SNL) and worked to develop a paradigm for accelerated materials certification for fusion energy (with LLNL). Through this project, we developed theoretical models and identified physical observables that can be measured by experiment to test these models that when taken together will accelerate the rate at which we can design and discover new materials to meet these certification challenges.

Scientific Approach and Accomplishments

On the major experimental/modeling effort under this project, the Dynamic Materials Performance effort, we have significant findings from polycrystal experiments and single crystal simulations on how phase transformation is preceded by deformation modes and the dependence on shock direction. Our key finding, gleaned from atomistic simulations, is that a new mode becomes active under extremes of shock and mediates the transformation process [1]. The mode is an effective 90 degree crystal rotation of the parent and would not have been distinguished from the usual 84.6 degree twinning seen in our ex situ shocked samples [2,3]. Moreover, emphasizing the anisotropic nature of the shock response, this mode was predicted to be active only in the c direction of the hexagonal crystal and has ramifications on grain boundary motion [4,5,6]. Preliminary analysis of the LCLS diffraction data on Ti single crystals, using the MEC pump-probe station, appears to corroborate this result. However, a direct comparison of the predicted diffraction patterns with the experimental data is ongoing. The synergy between theory, simulations and experiments is aptly demonstrated by our studies on the kinetics of the coupled transformation and deformation process [6]. By analyzing shocked samples at APS, we derived estimates of the activation barriers between phases and showed how this depends on shock peak stresses and the role of heterogeneous nucleation from dislocations in the microstructure. The importance of this study on the reverse transformation cannot be overemphasized as it was work in the 1980s on the forward transformation in Ti that inspired a similar equation for kinetics that is used in high pressure studies relevant to mission needs. We have now proposed a new phenomenological model in terms of evolution of dislocation densities coupled to phases [8]. Thus, through the above studies we have identified a need

for further single crystal experiment measurements to probe the interplay and collective behavior of deformation and transformation processes.

For our Linac Coherent Light Source (LCLS) activities, crucial to demonstrating use of an x-ray free electron laser (XFEL), we performed laser-driven shock experiments investigating deformation and phase transition mechanisms in two materials, SiO₂ and Ti.

SiO₂: (Experiment performed at beginning of year 2) We performed the first shock-driven experiments on SiO₂ that utilized an in situ x-ray diffraction measurement to diagnose the crystalline structure of the material. SiO₂ is an important geophysical material, and knowledge about its dynamic deformation and phase transition behavior is essential to developing a correct understanding of planetary impact events. A high-pressure crystalline polymorph of SiO₂, stishovite (tetragonal, P4₂/mnm), is found at bolide-impact craters on the Earth's surface, presumably having been generated under shock-compression conditions. The shock compression experiments performed in this project have provided information critical to understanding atomistic processes of nucleation and growth of crystalline stishovite from amorphous fused silica, and they have revealed that shocked crystalline quartz transforms to crystalline stishovite via an intermediate amorphous phase. The high fidelity of these in situ x-ray diffraction data have allowed the determination of grain growth rates of the stishovite crystals during shock compression, and the grain growth rates suggest that the mechanism of nucleation and growth changes with increasing shock stress. The first publication from this experiment is currently under review for publication in Nature.

Ti: (Experiment performed at beginning of year 3) Titanium is the primary constituent of alloys that are used in demanding engineering applications for their high strength and light weight. It is well established that titanium deforms through a combination of line and planar defects (slip and twins) and then, at high stresses, also through a volumetric collapse (phase transformation). However, the relative contributions of these deformation mechanisms to properties like strength are not known, particularly under dynamic loading conditions. We performed shock-driven experiments on titanium and titanium alloys at LCLS to examine the relationship between defects and strength in Ti by measuring the shock response of pure Ti and of Ti with varying amounts of oxygen-impurities. The resulting in situ x-ray diffraction data shows the kinetics of deformation twinning in Ti and shows that increasing the amount of oxygen impurities in the Ti results in suppression of twinning as a mechanism of plastic deformation. It was previously thought, based on shocked velocimetry data,

that high oxygen content had the ability to prevent the transformation from the low pressure crystalline phase to the high pressure crystalline phase, but our diffraction data definitively contradicts the previous conclusions by observing the atomic structure of the transformed phase when shocked to high pressure. We are continuing analysis of the single crystal and polycrystalline experimental data and preparing it for journal publication.

Measurement of temperature in extreme environments is a major R&D activity for developing advanced certification of materials. In the first of our three thermometry activities, the spontaneous Raman approach, we performed continuous wave measurements to 900 K accompanied by writing automated data acquisition and analysis software. Pulsed measurements on statically heated samples were performed over the next few months. We constructed a cell capable of testing static samples from liquid nitrogen to >900 K. We assembled a Stokes/anti-Stokes Raman Detection system, wrote LabView acquisition software, and tested several algorithms for fluorescent background subtraction and real time (few Hz) conversion to temperature. This was tested with CW lasers, but is mobile for transition to the microsecond and nanosecond laser laboratories. We measured Raman spectra/temperatures of quartz to 900 K. We performed maintenance to restore operation to the microsecond laser, which is now performing normally. Calculations relating experimental observations to theoretical predictions of parametric effects began. The static temperature test cell, spectrometers, detectors, and lasers were all assembled from available equipment at low cost.

A second approach to measuring temperatures involves analyzing patterns in the diffraction signals. This includes assessing the effects on both the integrated peak intensities (Debye-Waller factor) and the peak shapes (Thermal Diffuse Scattering). Here, Molecular Dynamics simulations were performed to prepare small (many millions of atoms) samples in various temperature and shock states, and an accurate diffraction calculation program was developed here and used to generate the associated diffraction spectra for specific experimental configurations. Some analyses were performed on simulations of shocked Zr in order to correlate with the Dynamic Materials Performance effort. However, the presence of the phase transformations of that material overly complicated our analysis, where a very large number of defect structures and associated very small crystalline domains are generated that resulted in excessively blurred peaks for the sample sizes and time scales accessible by this approach. Consequently, the effort focused on Cu samples. Here, assessments on thermally prepared samples (77-600K) showed that correlations of integrated peak intensities would generate values

for temperatures that were accurate to <5%. The primary limitation was not accurately knowing the classical Debye temperature for the potential function used, compared to that for the actual material. The peak shapes, particularly the intensity in the wings of the peaks, also reflected the changes in temperature, but this was difficult to evaluate accurately. Assessments were also performed on various shocked samples. For samples where only a small amount of plastic deformation occurred, temperatures could be evaluated from the peak intensities to an accuracy of ~5%, based on the classical Hugoniot jump conditions and heat capacity. For strong shocks with large amounts of plastic deformation that produced crystallite domains with dimensions of ~10 unit cells (comparable to the Zr samples above), assessments were not possible because of the insufficient peak resolution. This method of temperature evaluation requires knowing an accurate crystal orientation, the number of atoms in the crystal, and that either many diffraction peaks from the same crystal can be observed or that several neighboring crystals (from which different single diffraction peaks are observed) have the same temperature. In practice for dynamic measurements, this information would be available, but it would be obtained through an integrated reconstruction and analysis of all the deformation processes of the samples.

Finally, a third approach to measuring temperatures using stimulated rather than spontaneous Raman received some attention. The setup developed under the LDRD project allows us to detect stimulated Raman signals in up to 500 cm^{-1} range which can be extended to higher frequencies (~2000 cm^{-1}) with minor modifications. It operates at 1 KHz which should potentially provide 1 ms temporal resolution in single-shot experiments. One of the femtosecond pulses can be shaped using spatial light modulator in order to achieve the highest signal-to-noise levels and optimal Raman mode excitation. The performance of the system has been tested at and below room temperature using sapphire and fused silica as test samples. Simultaneously, a vacuum chamber has been set up that allowed testing at target temperatures of >1000K and testing CARS applicability to extreme conditions expected in MARIE experiments.

This system is not limited to temperature measurements and has created a new capability at CINT for various experiments in material science. We have established collaboration with researchers from Oregon State University who are interested in applying our approach for understanding heat conduction mechanisms in Raman-marked long biomolecules, e.g. DNA.

On the radiation front, our LANL/TAMU collaboration continued its activities in the Ion Beam Materials Laboratory

(IBML). The corrosion chamber design and off-site test was done at the TAMU in collaboration with INL and LANL. The chamber was installed in the IBML in July/August 2013 and the irradiation experiment was scheduled in the Aug./Sept. 2013 time frame.

Impact on National Missions

The need to predict and control materials in extremes spans the full range of DOE missions from weapons performance to energy security. Further, successful nuclear weapons program approaches to certification of materials performance (and the associated quantification of performance margins and uncertainty) have not e.g., been translated to nuclear energy materials certification challenges. In this project, we addressed specific process-aware materials performance challenges in our enduring nuclear weapons stockpile and worked to develop a paradigm for accelerated materials certification for fusion energy.

References

1. Qvist, , A. M. Bolind, Hosemann, Wang, Tesmer, M. S. De Caro, and Bourke. Capability demonstration of simultaneous proton beam irradiation during exposure to molten lead-bismuth eutectic for HT9 steel. 2013. NUCLEAR INSTRUMENTS & METHODS IN PHYSICS RESEARCH SECTION A-ACCELERATORS SPECTROMETERS DETECTORS AND ASSOCIATED EQUIPMENT. 698: 98.
 2. McGrane, S. D., D. S. Moore, P. M. Goodwin, and D. M. Dattelbaum. Quantitative Tradeoffs Between Spatial, Temporal, and Thermometric Resolution of Nonresonant Raman Thermometry for Dynamic Experiments. 2014. APPLIED SPECTROSCOPY. 68 (11): 1279.
- Cerreta, E. K., F. L. Addessio, C. A. Bronkhorst, D. W. Brown, J. P. Escobedo, S. J. Fensin, G. T. Gray III, Lookman, P. A. Rigg, and C. P. Trujillo. The influence of peak shock stress on the high pressure phase transformation in Zr. 2014. 18TH APS-SCCM AND 24TH AIRAPT, PTS 1-19. 500.
- Cerreta, E. K., J. P. Escobedo, P. A. Rigg, C. P. Trujillo, D. W. Brown, T. A. Sisneros, Clausen, M. F. Lopez, Lookman, C. A. Bronkhorst, and F. L. Addessio. The influence of phase and substructural evolution during dynamic loading on subsequent mechanical properties of zirconium. 2013. ACTA MATERIALIA. 61 (20): 7712.
- McGrane, S. D., D. S. Moore, P. M. Goodwin, and D. M. Dattelbaum. Quantitative Tradeoffs Between Spatial, Temporal, and Thermometric Resolution of Nonresonant Raman Thermometry for Dynamic Experiments. 2014. APPLIED SPECTROSCOPY. 68 (11): 1279.
- Qvist, , A. M. Bolind, Hosemann, Wang, Tesmer, M. S. De Caro, and Bourke. Capability demonstration of simultaneous proton beam irradiation during exposure to molten lead-bismuth eutectic for HT9 steel. 2013. NUCLEAR INSTRUMENTS & METHODS IN PHYSICS RESEARCH SECTION A-ACCELERATORS SPECTROMETERS DETECTORS AND ASSOCIATED EQUIPMENT. 698: 98.
- Zong, , Ding, Lookman, J. u. Li, J. u. n. Sun, E. K. Cerreta, J. P. Escobedo, F. L. Addessio, and C. A. Bronkhorst. Collective nature of plasticity in mediating phase transformation under shock compression (vol 89, 220101, 2014). 2014. PHYSICAL REVIEW B. 90 (1).
- Zong, , Lookman, Ding, Luo, and J. u. n. Sun. Anisotropic shock response of titanium: Reorientation and transformation mechanisms. 2014. ACTA MATERIALIA. 65: 10.
- Zong, , Lookman, Ding, Nisoli, D. o. n. Brown, S. R. Niezgod, and S. u. n. Jun. The kinetics of the omega to alpha phase transformation in Zr, Ti: Analysis of data from shock-recovered samples and atomistic simulations. 2014. ACTA MATERIALIA. 77: 191.
- Zong, , Xue, Ding, and Lookman. Phase transformations in Titanium: Anisotropic deformation of omega phase. 2014. 18TH APS-SCCM AND 24TH AIRAPT, PTS 1-19. 500.

Publications

Cerreta, E. K., F. L. Addessio, C. A. Bronkhorst, D. W. Brown, J. P. Escobedo, S. J. Fensin, G. T. Gray III, Lookman, P. A. Rigg, and C. P. Trujillo. The influence of peak shock stress on the high pressure phase transformation in Zr. 2014. 18TH APS-SCCM AND 24TH AIRAPT, PTS 1-19. 500.

Cerreta, E. K., J. P. Escobedo, P. A. Rigg, C. P. Trujillo, D. W. Brown, T. A. Sisneros, Clausen, M. F. Lopez, Lookman, C. A. Bronkhorst, and F. L. Addessio. The influence of phase and substructural evolution during dynamic loading on subsequent mechanical properties of zirconium. 2013. ACTA MATERIALIA. 61 (20): 7712.

McGrane, S. D., D. S. Moore, P. M. Goodwin, and D. M. Dattelbaum. Quantitative Tradeoffs Between Spatial, Temporal, and Thermometric Resolution of Nonresonant Raman Thermometry for Dynamic Experiments. 2014. APPLIED SPECTROSCOPY. 68 (11): 1279.

Meso-Photonic Materials

Houtong Chen
20140123DR

Abstract

This LDRD-DR project investigated the feasibility of using meso-photonic materials serving as the intermediate structure, which is the most important component in solar thermophotovoltaics. We designed, fabricated, and characterized a broadband meso-photonic structure that was capable of absorbing the incident light with efficiency higher than 90% over the entire solar spectrum. We also carried theoretical studies of plasmon and spoof polariton modes in meso-photonic metallic structures and their potential to enhance radiative heat transfer. This work supports the national mission in energy security and, more generally, addresses some grand challenge questions regarding key technological gaps in photonics.

Background and Research Objectives

In conventional photovoltaics (PV), the efficiency is limited due to the loss of unabsorbed photons with energy below the semiconductor bandgap and the excess energy loss in photons with energy above the bandgap. As a result, the maximum theoretically achievable power conversion efficiencies of single junction solar cells, also called the Shockley-Queisser (SQ) limit, are 31% under diffuse and 41% under concentrated solar light. Solar thermophotovoltaics (STPV) seeks to eliminate these loss mechanisms and overcome the SQ limit by coupling the PV cell with an intermediate structure that absorbs solar radiation, heats up, and re-emits the absorbed energy in a narrow spectral band directly above the band gap of the PV cell, schematically illustrated in Figure 1(a). Because the emitter is spectrally matched to the PV cell, the power conversion efficiency is no longer limited by the SQ limit. Theoretical analysis shows that STPV could achieve efficiencies up to 54% and 85% in diffuse and concentrated sunlight, respectively. However, experimental demonstrations using conventional approaches without photonic structures only realized a conversion efficiency $\sim 1\%$. The current state-of-the-art efficiency is only 3% using carbon nanotubes as the absorber and a photonic crystal as the emitter, where the low perfor-

mance is mainly due to the poor wavelength selectivity of the photonic crystal emitter.

Meso-photonic materials, effective media whose optical properties are mainly determined by the collective response of the tailored subwavelength metal/dielectric structures rather than by the composing materials, have the potential to revolutionize the manipulation of light propagation and light-matter interactions. Built upon our meta-molecule-based meso-photonic concept, one of our goals in the DR proposal is the development of novel meso-photonic materials for renewable energy applications. Our objective was to create novel meta-molecule-based meso-photonic materials for highly efficient intermediate structures, and demonstrate proof-of-concept STPV devices potentially exceeding the efficiency in conventional PV cells.

Scientific Approach and Accomplishments

We carried out initial investigations, both theoretically and experimentally, to design, fabricate, and characterize meso-photonic structures suitable for serving as the intermediate structure in a STPV system. In our approach, both the front and the back of the intermediate structure consist of meta-molecule arrays (insets to Figure 1(b) and (c)) separated from a metal ground plane by an ultrathin dielectric spacer. The front functions as a broadband, wide-angle solar absorber, trapping the incident light and converting it to heat via ohmic and dielectric losses.

In our feasibility study we have designed the meta-molecule array via full-wave numerical simulations using commercially available software packages CST Microwave Studio and COMSOL Multiphysics. Our preliminary studies used a heuristic design approach based on symmetry considerations and trial and error searches. It works well for relatively simple meta-molecules with few design parameters, where the functionalities can be predicted by rationally analyzing the inter-coupling of meta-atoms

and verified through rapid parameter sweeping by exact full-wave numerical simulations. The designed structure was then fabricated in CINT cleanroom through ebeam lithography approach. The SEM image shown in the inset to Figure 1(b) illustrates the fabricated meta-molecule array consisting of 16 meta-atoms with various geometries and dimensions built from 50 nm thick gold film, which are separated from a 200 nm thick gold ground plane with a 60 nm thick silicon dioxide spacer. Both the gold and silicon dioxide films were deposited by ebeam evaporation. The fabricated device was characterized via both Fourier transform infrared spectroscopy (FTIR) and a supercontinuum white light source, which give consistent results as shown in Figure 1(b). We demonstrated higher than 90% average absorption covering a large portion of the solar spectrum, which is in excellent agreement with numerical simulations (Figure 1(b)).

This promising accomplishment forms the solid foundation for new LDRD project, starting in FY15, where more in-depth investigations of the intermediate structure will be undertaken to develop meso-photonic structures capable of operating at elevated temperatures (>1000 K, via appropriate sunlight concentration), as needed in a practical STPV system. Under these conditions, the blackbody emission spectrum peak approximately matches the intermediate structure's emissivity maximum. Gold will need to be replaced by tungsten or other refractory materials to increase the melting point, and SiO₂ may be replaced by Al₂O₃. Additionally, the metallic meso-structure may need to be imbedded within the dielectrics to prevent metal from evaporating.

On the theory side, we have studied plasmon and spoof polariton modes in meso-photonic metallic structures and their potential to enhance radiative heat transfer. Spoof surface modes on nanostructured metallic surfaces are known to have tailorable dispersion dependent on the geometric characteristics of the periodic pattern. We have examined the spoof plasmon dispersion on an isolated grating and a grating-planar mirror cavity configuration. The spoof polariton dispersion in the cavity was obtained using the scattering matrix approach, and a related differential modal density of states was introduced to obtain the mode dispersion and classify the cavity polariton modes. The grating-mirror cavity geometry is an example of periodically nanostructured metals above a planar ground plane. These properties are relevant for applications ranging from thin electromagnetic perfect absorbers to near-field radiative heat transfer. This work resulted in a publication, P.S. Davids, F. Intravaia, and D. A. R. Dalvit, "Spoof polariton enhanced modal density of states in planar nanostructured metallic cavities", *Optics Express* 22, 12424 (2014).

Impact on National Missions

The development of next generation meso-photonic materials will strongly impact the needs of the Laboratory and the Nation in a host of photonics applications. In particular, this LDRD-DR Reserve project performed feasibility studies of the meso-photonic material based intermediate structure for solar thermophotovoltaics to address the national energy security mission. More generally, our research in meso-photonic materials addresses some grand challenge questions regarding key technological gaps in photonics, as described in the 2012 National Research Council report, and is aligned with New Mexico's Technology21 Roadmap for Science and Technology, which lists photonics as an important component to improve the economic strength in the state. Our meta-molecule-based meso-photonic materials will lead to new sensing and communication approaches for national security missions, such as nuclear non-proliferation. Our work will strengthen our ability to perform co-design for functional materials, underpinning an important capability for MaRIE, and leverages the fabrication and characterization capabilities in CINT, a DOE national user facility.

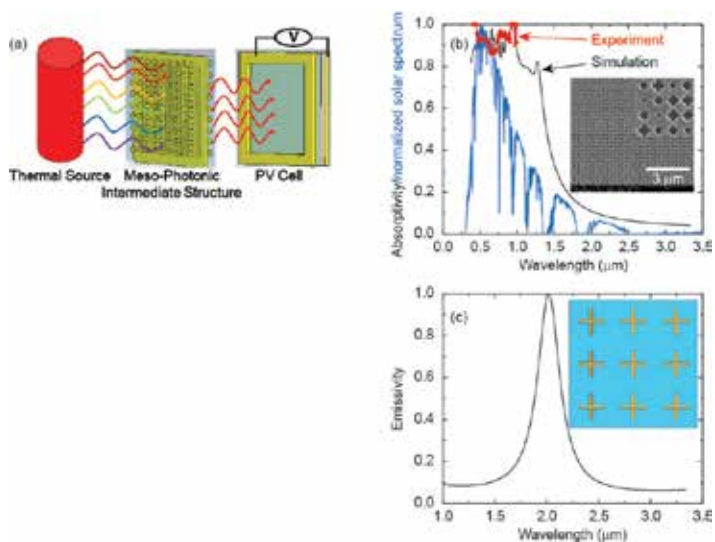

Figure 1. (a) Conceptual schematic of a STPV structure with an intermediate absorber/emitter meso-photonic material. (b) Normalized solar AM1.5 spectrum (blue), and numerically simulated (black) and experimentally measured (red) absorptivity of the front meso-photonic structure. Inset: SEM image of the fabricated meta-molecule array consisting of 16 meta-atoms with various geometries and dimensions built from 50 nm thick Au film, which are separated from a 200 nm thick Au ground plane with a 60 nm thick SiO₂ spacer. (c) Numerically simulated emissivity of the back side of the photonic structure shown in the inset.

Publications

Davids, P. S., Intravaia, and D. A. R. Dalvit. Spoof polariton enhanced modal density of states in planar nanostructured metallic cavities. 2014. *OPTICS EXPRESS*. 22 (10): 12424.

Room Temperature Oxidation and Corrosion of Plutonium

Alison L. Pugmire
20130738ECR

Introduction

Currently, a systematic investigation of plutonium corrosion under room temperature, pressure and humidity has yet to be performed. This work proposes to use a carefully controlled environment to form the oxide layer on well-characterized Pu metal samples. At various times during the corrosion process, a combination of spectroscopic tools will probe both the surface layer (spectroscopic ellipsometry, SE; x-ray photoelectron spectroscopy, XPS) and the bulk material (x-ray diffraction, XRD; x-ray absorption fine structure, XAFS). This work will also aim to address a long-standing issue with plutonium metal experiments: variability in the sample preparation and resultant reproducibility. These issues will be addressed by utilizing a consistent and controlled preparation method and conducting the experiments on various samples and/or different areas of the same sample to ensure repeatable and, more importantly, reliable results.

Many questions remain regarding the room temperature/pressure mechanism of plutonium corrosion. What is the chemical composition of the corrosion products (PuO₂, Pu₂O₃, etc.)? Is the surface layer oxide crystalline PuO₂ or an amorphous oxide mixture as recent investigations indicate? Is Pu₂O₃ present at the PuO₂-metal interface? Why are seemingly different results obtained for ultra-high vacuum conditions versus “real world”, ambient conditions? The proposed work aims to answer these fundamental questions with a comprehensive surface and bulk layer study at conditions most relevant to the storage and use of plutonium: near room temperature and pressure.

Benefit to National Security Missions

Los Alamos National Laboratory (LANL) is the premier institution for plutonium science, with a rich history of excellence in actinide research and development, pit manufacturing, and surveillance. The laboratory's mission is to “ensure the safety, security, and effectiveness

of the U.S. nuclear deterrent.” The core of this mission is to ensure the reliability and performance of the nation's weapons systems currently in the stockpile. Interest in the health of the nuclear stockpile has been heightened in recent months due to the Department of Energy (DOE) and LANL's recent commitment to pit reuse. As stated by LANL Director Charlie McMillan in a June 27, 2012 All-Hands Meeting, “Pit reuse is now a certification ‘grand challenge, one of the most complicated we have ever faced.” Plutonium corrosion has been identified as a key issue in pit aging and reuse, and the current state of corrosion knowledge has been recognized as limited at best. Thus, this research directly addresses the laboratory's mission to ensure the effectiveness of the stockpile and the challenges facing certification of pits for reuse.

Progress

Over the past 12 months, the facility (PF-4) in which much of the work was to be performed was paused (June 2013). As a result, more emphasis was placed on using other techniques in the project with more in-depth analysis. These techniques are either off-site (Stanford Synchrotron Radiation Laboratory, SSRL) or at another LANL facility (Target Fabrication Facility, TFF, TA-35). Despite the unavailability of PF-4 for programmatic work, significant progress towards the goals of this project have been made.

At the time of the last LDRD report, analysis of the X-ray Absorption Fine Structure (XAFS) data collected in Year 1 was still on-going. In addition, a proposal requesting more experimental (beam) time was submitted to SSRL. In the last 12 months, the Year 1 analysis has been completed, and the SSRL proposal was accepted and granted experimental time. This beam time allocation was a significant accomplishment because it marked the first time the (LDRD) P.I. was the lead P.I. on a beam time proposal. The results from the Year 1 data analysis indicated additional experiments, at different time points and on

the originally prepared samples, were necessary. These experiments have been performed, and the data subsequently analyzed. To expand the scope of work at this facility, gallium XAFS and surface XAFS experiments were also conducted. Ga XAFS measures the local bonding environment of the Ga atoms in the alloyed delta-plutonium, providing information on the role of Ga in the oxidation and corrosion of Pu. The surface XAFS measures the surface (the top 0.500 -0.850 micron layer). This experiment provides a surface sensitive technique compared to the typical XAFS experiment that probes ~ 1.5 – 4 microns of material. Both experiments were conducted, and the data analyzed. The Ga XAFS results provided information complimentary to the Pu XAFS data that enhanced our understanding of Pu corrosion. The surface XAFS experiments were the first experiments by the PI utilizing this technique on Pu metal. These initial experiments identified key preparation and experimental issues that will guide future experiments.

The experimental work at LANL has been focused on establishing a new Pu experimental capability at another facility (TFF). Spectroscopic ellipsometry is a surface science technique that will provide in-situ measurements of the oxidation and corrosion process. The optical constants of “clean” Pu metal will be determined and measured. The metal will then be exposed to various exposure conditions (O₂, H₂O, etc.) at room temperature and the oxide thickness measured. In the last 12 months, the necessary equipment has been acquired and assembled. Non-radiological testing has also been performed on tantalum and SiO₂ standards. The setup is near completion and Pu experiments are forthcoming.

Overall, significant advances have been made in the last 12 months towards our understanding of the corrosion of plutonium at room temperature. The XAFS work and the XPS data collected in the first year will be presented at the Pu Futures – The Science 2014 Conference in Las Vegas, NV in September 2014. A manuscript describing these results is also currently in preparation. Additional manuscripts describing the upcoming SE work are also anticipated.

Future Work

The latter part of the LDRD Year 2 (June 2014 - January 2015) will carry over into FY15. The last 7 months of this LDRD will be spent taking and analyzing data to develop a description of the room temperature corrosion process. The tasks and goals to be accomplished in the next fiscal year (FY15 1st quarter) are listed.

Task 1: Complete the experimental setup of a new Pu capability in another facility (Target Fabrication Facility, TFF, LANL, TA-35). This requires installation of all the necessary Pu safeguards in addition to the experimental components.

Task 2: Conduct in-situ room temperature exposure experiments using the spectroscopic ellipsometer (SE) and any other available techniques. (3) Task 3: Complete the data analysis on any remaining x-ray absorption fine structure (XAFS) data collected throughout the project at the Stanford Synchrotron Radiation Lightsource (SSRL) and analyze any SE data collected in the last quarter of the project. (4) Task 4: Present results (conference, workshop, manuscripts); determine optimal characterization techniques most appropriate and useful for potential future work; use the results of this work to develop a description of the room temperature corrosion of Pu.

Conclusion

The goals of this research are to study the ambient oxidation/corrosion mechanism of plutonium using a systematic approach to prepare the specimens; develop the oxide layer as a function of humidity, oxygen content, and exposure; and study the oxide layer using multiple techniques. Expected results include determination of the chemical (e.g. PuO₂, Pu₂O₃, and/or PuO_xC_y) and structural composition (e.g. crystalline or amorphous) of the surface and bulk oxide layer. These results will help develop a comprehensive picture of the room temperature corrosion of Pu, impacting our understanding of Pu aging in the stockpile.

Publications

- Booth, C. H., Y. Jiang, S. A. Medling, D. L. Wang, A. L. Costello, D. S. Schwartz, J. N. Mitchell, P. H. Tobash, E. D. Bauer, S. K. McCall, M. A. Wall, and P. G. Allen. Self-irradiation damage to the local structure of plutonium and plutonium intermetallics. 2013. JOURNAL OF APPLIED PHYSICS. 113 (9): -.
- Pugmire, A. L.. Spectroscopic Analysis of Actinyl Systems. 2013. Actinide Research Quarterly. (3): 18.
- Pugmire, A. L., C. H. Booth, T. J. Venhaus, and D. L. Pugmire. Structural insights into the oxide formed during the room temperature corrosion of plutonium . Presented at Pu Futures - The Science 2014. (Las Vegas, NV, 7-12 Sept 2014).
- Pugmire, A. L., C. H. Booth, T. J. Venhaus, and D. L. Pugmire. Understanding the oxidation and corrosion of plutonium with EXAFS. Invited presentation at SSRL/LCLS Users' Meeting and Workshop. (Menlo Park, CA, 7 - 10 Oct. 2014).
- Pugmire, D. L., H. G. Garcia Flores, and A. L. Costello. The room temperature oxidation/corrosion of delta plutonium. Presented at XIII International Workshop: Fundamental Properties of Plutonium. (Sarov, Russia, 8-13 Sept. 2013).
- Pugmire, D. L., H. Garcia Flores, A. L. Pugmire, and D. P.

Moore. The room temperature oxidation/corrosion of delta-Pu: historical perspective vs. modern understanding . Invited presentation at Pu Futures - The Science 2014. (Las Vegas, NV, 7-12 Sept 2014).

Novel Mesoscale Modeling Approach for Investigating Energetically Driven Nanoscale Defect/Interface Interactions

Abigail Hunter
20130745ECR

Introduction

In nanomaterials (grain sizes less than 100nm), experimental studies and atomistic simulations show that when the characteristic length scale (ex: layer thickness, grain size) decreases many deformation mechanisms arise that are not active in bulk and coarse-grained material counterparts, such as dislocation emission and absorption at grain boundaries and interfaces, dislocation pile-ups, confined layer slip, and deformation twinning. These alternative deformation mechanisms, along with grain boundaries and bimetallic interfaces, can result in unique material behavior including high strength and improved ductility. As applications for nano-devices increases, there is not only a growing need to ensure reliability, but also the opportunity to engineer materials for specific applications, however a predictive model to address these issues still does not exist.

This project is focused on investigating nanoscale defect/interface interactions, such as nucleation and growth of deformation twins, and dislocation dynamics as controlled by interfaces through development of an innovative three-dimensional (3D) phase field dislocation dynamics (PFDD) mesoscale model that links atomic-scale and nanoscale physics. This model is unique at Los Alamos National Laboratory (LANL), and has great potential to answer many questions about the effects of deformation twinning, and the impact of grain boundaries and heterophase interfaces on dislocation and material strength behavior. The goals of this project include innovative extensions of the 3D PFDD model that will not only be new in the scientific community, but will also answer many questions about dislocation behavior on the nanoscale, particularly at interfaces. Model advancements as part of this project include: incorporation of temperature dependence, implementation of a complex description of nanolayer interfaces, and reformulation to account for body-centered cubic (bcc) crystal structures. Development of this computational tool will enable the study of deformation mechanisms at interfaces not possible

with current mesoscale methods.

Benefit to National Security Missions

Understanding the effects of defects and interfaces on material behavior as materials age becomes increasingly important for determining the performance, reliability, and safety of weapon systems. Los Alamos National Laboratory (LANL) has advanced atomistic and continuum simulation tools, however, it is not clear how to connect information on these two very different length scales. Hence, there remains a computational gap at the mesoscale that translates into a gap in our understanding of material deformation. The phase field dislocation dynamics (PFDD) model aims to fill this gap, and produce predictive multiscale simulations crucial for stockpile stewardship.

The goals of this proposal include innovative extensions of the PFDD model that will not only be new in the scientific community, but will also answer many questions about dislocation behavior on the nanoscale, particularly at interfaces. The proposed model advancements will be extensions that have not yet been achieved by current phase field dislocation models. These advancements will enable the PFDD model to investigate many defect/interface deformation mechanisms not possible with current mesoscale methods.

Progress

The primary goal of this project is to investigate nanoscale defect/interface interactions, such as nucleation and growth of deformation twins, and dislocation dynamics as controlled by interfaces through development of an innovative three-dimensional (3D) phase field dislocation dynamics (PFDD) mesoscale model that links atomic-scale and nanoscale physics. This model is unique to Los Alamos National Laboratory (LANL) and the novel extensions of the PFDD model achieved as part of this project will be both new to the scientific community and answer many questions about disloca-

tion behavior on the nanoscale, particularly at interfaces. Three goals are highlighted in this project: (1) investigate the effects of grain size variation and temperature dependence on deformation twinning in face-centered cubic (fcc) materials, such as copper, gold, and silver, (2) study dislocation behaviors in fcc/fcc multilayers, and (3) account for dislocation behavior in body-centered cubic (bcc) materials, such as tantalum, steel, and niobium.

Over the past year, much progress has been made toward achieving these three goals. A primary focus this year has been on studying the effects of grain size variation and temperature on deformation twinning in fcc metals resulting in several publications (collaborator: Irene Beyerlein, T-3). The PFDD model can study stacking fault and twin formation in nine fcc metals through direct connection to density functional theory (DFT). The model has predicted a new twin formation mechanism called alternate emission (AE), in which two leading partial dislocations, on adjacent planes and opposing grain boundaries, traverse the entire grain cross-section to form a two-layer twin. Current efforts are focused on determining the effects of low temperatures on the twinning behavior in these materials.

Research efforts have also continued to address fcc/fcc bimetallic interfaces in collaboration with Dr. Marisol Koslowski at Purdue University. The PFDD algorithm has been extended to account for the material properties of two different materials and perfect dislocation motion through the interface. This summer Yifei Zeng will return from Purdue to continue this work. His current efforts are addressing partial dislocation and stacking fault behavior through implementation of a complex energy landscape into the PFDD model at the interface region. This advancement follows from atomistic simulations completed in the previous year (collaborator: Ruifeng Zhang, Iowa State).

The final goal of this project requires reformulation of the PFDD model to account for the bcc crystal class. Rebecca Runnels, a student from NM-Tech, is spending this summer working on this problem. She has added new bcc materials to the PFDD model. In addition, she has implemented the necessary crystallographic orientations to account for the bcc crystal structure. During the remainder of the summer, she will address the differences in mobility between edge and screw oriented dislocations seen experimentally. The goal is to study kink formation in bcc metals later this year.

This project has resulted in several collaborations including those spanning divisions/groups within LANL, and external academic relationships. Several publications are currently underway, in addition to those already published or submitted.

Future Work

The goals of this project include innovative extensions of the three-dimensional (3D) phase field dislocation dynamics (PFDD) model that will not only be new in the scientific community, but will also answer many questions about dislocation behavior on the nanoscale, particularly at interfaces.

In the next fiscal year, work will focus on deformation twin formation at low temperatures. In this past year, the PFDD model has predicted a new twin formation mechanism called alternate emission (AE) mechanism. In the upcoming year, we will focus on studying the material and temperature dependence of this new mechanism along with other proposed twin formation mechanisms.

Preliminary simulations with face-centered cubic (fcc)/fcc interfaces have been completed. Following the resolution of a few numerical issues, this upcoming fiscal year we will study transmission of dislocations through copper/nickel interfaces. We will also continue to enhance our interface description by implementing a complex energy description for the interface, which will allow for partial dislocation motion and interaction in the bi-metallic interface region.

New materials and orientations required to model body-centered cubic (bcc) metals such as tantalum, steel, and niobium have already been incorporated into the 3D PFDD framework. Current efforts are focused on accurately accounting for the different mobilities seen experimentally in edge and screw oriented dislocations. Going into the next fiscal year, this will lead to interesting studies on kink formation and propagation in bcc materials. Time permitting, the PFDD model will be extended to account for cross slip, another dominant bcc deformation mechanism.

Conclusion

The primary goal of this proposal is to investigate nanoscale defect/interface interactions, such as nucleation and growth of deformation twins, and dislocation dynamics as controlled by interfaces through development of an innovative three-dimensional (3D) phase field dislocation dynamics (PFDD) mesoscale model that links atomic-scale and nanoscale physics. Model advancements as part of this project include: incorporation of temperature dependence, implementation of a complex description of nanolayer interfaces, and reformulation to account for body-centered cubic (bcc) crystal structures. Development of this computational tool will enable the study of deformation mechanisms at interfaces not possible with current mesoscale methods.

Publications

Beyerlein, I. J., J. S. Carpenter, A. Hunter, L. S. Toth, and W. Skrotzki. Nano-enabled orientation alignment via extreme shear strains. To appear in *Scripta Materialia*.

Cao, L., A. Hunter, I. J. Beyerlein, and M. Koslowski. The role of partial mediated slip during quasi-static deformation of 3D nano crystalline metals. To appear in *Journal of the Mechanics and Physics of Solids*.

Hunter, A., R. F. Zhang, I. J. Beyerlein, T. C. Germann, and M. Koslowski. Dependence of equilibrium stacking fault width in fcc metals on the gamma-surface. 2013. *MODELLING AND SIMULATION IN MATERIALS SCIENCE AND ENGINEERING*. 21 (2): -.

Hunter, A., R. F. Zhang, and I. J. Beyerlein. The core structure of dislocations and their relationship to the material g-surface. 2014. *Journal of Applied Physics*. 115: 134314:1.

Hunter, A., and I. J. Beyerlein. Unprecedented grain size effect on stacking fault width. 2013. *Applied Physics Letters Materials*. 1: 032109.

Hunter, A., and I. J. Beyerlein. Stacking fault emission from grain boundaries: Material dependencies and grain size effects. 2014. *Materials Science & Engineering A*. 600: 200.

Hunter, A., and I. J. Beyerlein. Predictions of an alternative pathway for grain-boundary driven twinning. 2014. *Applied Physics Letters*. 104: 233112:1.

Hunter, A., and I. J. Beyerlein. Relationship between monolayer stacking fault and twins in nano crystals. To appear in *Acta Materialia*.

Magnetic Field Effects on Convection-Modified Solid-Liquid Interfaces

Amy J. Clarke
20130755ECR

Introduction

In-situ characterization techniques are now affording direct imaging of metals during synthesis and processing. The pioneering first experiments performed by this team to monitor metallic alloy melting and solidification using x-rays and protons emphasized how structural development in metals can be explained by direct imaging. Feedback from in-situ characterization also enables in-process adjustments to control microstructural evolution and permits the advancement of solidification theory toward the development of predictive solidification and microstructural evolution models. This project explores the influence of a static magnetic field on alloy melt fluid flow and the appearance of the solid-liquid interface of metallic alloys during solidification, demonstrating a new approach to affect microstructural evolution during processing. We directly observe the impact of static magnetic field on fluid flow and modify the solid-liquid interface pattern development during solidification. Melt flows interact with solid interfaces at a variety of length scales, from the macro-scale down to the micro-scale dendritic tips, to influence the distribution of solute in the melt and microstructural evolution. Specific types of macro- and micro-scale fluid flows that are of interest in solidification processing have been achieved in this project by controlling geometry, heat flux, and the application of a static magnetic field. In-situ imaging with synchrotron x-ray radiography at Argonne National Laboratory's Advanced Photon Source and proton imaging at the Los Alamos Neutron Science Center have been used to observe alloy melt fluid flow, solid-liquid interfacial shape, local composition, and microstructural evolution under the application of a static magnetic field during solidification. Understanding how static magnetic field can influence fluid flow and structural development in metals will enable the achievement of advanced manufacturing initiatives and the creation of materials by design.

Benefit to National Security Missions

Convection of an alloy melt during casting mold filling plays a critical role in the solute segregation that develops at the macro-scale, whereas localized convection cells that develop during solidification drastically influence micro-scale solute segregation and morphological and microstructure evolution. Application of a magnetic field during solidification provides an opportunity to affect alloy melt fluid flow characteristics and the interface shape and dynamic equilibrium at that interface. Materials for the future, including the creation of materials with application-tailored properties to achieve controlled functionality by directed synthesis and processing, is one of three science pillars at Los Alamos National Laboratory. Controlling materials synthesis and processing and the design of materials functionality through the exploitation of defects and interfaces, understanding the dynamic evolution of materials, defect structures, and interfaces, and the use of novel characterization techniques, especially at extremes, are priorities listed in Los Alamos National Laboratory's Directed Research and Development Defects and Interfaces in Materials (DIM) Exploratory Research Category. These priorities are also reflected in the laboratory's Matter-Radiation Interactions in Extremes (MaRIE) Signature Facility vision, and are deeply rooted in nationally recognized needs identified by the U.S. DOE Basic Energy Sciences, The National Academies, and the White House Office of Science and Technology Policy's Materials Genome Initiative (MGI).

Progress

The role of magnetic field on macro-scale alloy melt fluid flow and micro-scale solid-liquid interface pattern development has been examined using real-time x-ray and proton imaging at Argonne and Los Alamos National Laboratories, respectively. X-rays permit microstructural examinations of a small field-of-view in thin metal sections, whereas protons allow for imaging of larger fields-of-view in thin and thick metal sections. Proton imaging was used to measure the macro-scale influences

of a magnetic field on casting mold filling and x-ray imaging was used to observe initial microstructural development in the presence of a magnetic field. These complementary experiments enabled the relative effectiveness of the imposed magnetic field to modify fluid flow and structural evolution to be directly assessed.

For both the x-ray and proton imaging experiments, permanent neodymium-iron-boride magnets were used to provide a uniform static magnetic field. One magnet was placed on either side of the metal sample during casting and solidification. The size, strength and location of the magnets in the experimental area were designed to provide a Hartman number (the ratio of the induced magnetic force to the viscous force) large enough to modify the flow behavior during metal casting. For the relevant geometries, this required an effective magnetic field minimum of ~ 1200 gauss. The same magnetic field was imposed on samples for both x-ray and proton imaging. The experiments were performed using a tin-27 at.% bismuth alloy to take advantage of the high x-ray absorption contrast between the tin-rich initial solid and the bismuth-enriched liquid during solidification.

Preliminary results from the proton imaging experiments indicate that the introduction of a static magnetic field across the casting mold cavity modified the behavior of the liquid metal during filling. Direct imaging of casting mold filling was performed at imaging rates greater than 10 Hz. These images enabled the first high-resolution measurements of the fluid stream and initial splashing during the filling of the mold cavity to be made. An increase in width of the metal stream was observed in the presence of the static magnetic field, suggesting that the velocity of the falling liquid was effectively decreased. In addition, less splashing and droplet separation were observed during the introduction of the metal to the cavity, resulting in improved filling of the cavity and a decrease in the susceptibility of the part to surface defects that could influence casting quality. Subtle changes in the liquid surface shape during filling were also observed in the presence of the static magnetic field.

Direct imaging of solidification with x-rays enables the measurement of branched (tree-like), dendritic structures that form as the first solid in the metal. In the presence of a static magnetic field, overall refinement of the dendritic structure was observed (i.e., decrease in spacing between the primary dendrites). Reduced dendritic spacing is essential for improving the properties and performance of cast parts. The appearance of the dendritic side branches also changed with the application of static magnetic field. The branches became more frequent, but less prone to further growth, implying that the fluid flow and mixing

adjacent to the dendrite arms was effectively suppressed.

In addition to the direct imaging experiments, finite element modeling was performed to estimate the fluid velocities in the liquid in the absence of an imposed magnetic field. These results suggest that complex convection cells develop, even in relatively thin samples, which will affect solidification front development. These results will be compared to the x-ray and proton images obtained under a static magnetic field to further our understanding about how magnetic field effects might be incorporated into modeling.

Future Work

We will continue to analyze the data from the existing x-ray and proton imaging experiments with a static magnetic field, focusing on how static magnetic field affects macro-scale fluid flow and microstructural development for a publication. We will also compare the proton imaging movie of a casting with finite element casting simulations to suggest mechanism(s) for understanding the long-range influence of static magnetic field on casting technology.

Conclusion

In this project, we explore the role of static magnetic field on alloy melt fluid flow and solid-liquid interfaces during solidification relevant to casting mold filling and microstructural evolution. We use synchrotron x-ray and proton imaging to create movies during solidification to monitor the potential for static magnetic field to modify fluid flow and solid-liquid interface pattern development. The use of static magnetic field during solidification will provide a set of broadly applicable microstructure and property control schemes for the creation of structural alloys.

Effects of Joining Processes on Bimetal Interface Content and Radiation Damage Resistance

John S. Carpenter
20130764ECR

Introduction

A fundamental study of the effect of pre-existing interfacial structure on the joinability and resulting material properties of bulk nanostructured metals (BNM) is proposed. BNMs, due to the nanometer length scale, have material properties and behaviors that arise as a result of two factors: 1) interfacial type and 2) interfacial density. Success has been achieved in fabricating strong and lightweight BNMs with industrial methods that exhibit properties that far exceed those of bulk metals through purposeful manipulation of both interfacial density and interface type. In order for BNMs to be used in engineering applications, however, the reaction of the interfacial density and interface type to industrial joining processes must be evaluated.

The Cu-Nb bimetallic multilayer nanocomposite system has been selected as the model system for the proposed work. Controlled interfacial structures and controlled nanoscale interfacial densities in a bulk sheet form appropriate for joining studies have been demonstrated at LANL. Understanding the physics that govern the dynamic and thermal stability of interfaces in Cu-Nb nanolamellar material will be valuable for the joining of any material, BNM or otherwise, where interfaces comprise the primary control on material behavior and properties.

Cu-Nb multilayers also exhibit outstanding material behavior such as high strength, thermal stability, and ultrahigh resistance to both shock and radiation damage. Given the properties exhibited by Cu-Nb composites, a range of potential applications exist such as nuclear fuel cladding, armor for defense applications, and as a strong, lightweight structural material in transportation. A secondary goal of this proposal, therefore, is to explore methods for joining Cu-Nb nanolamellar material in order to unlock its potential as a lightweight manufacturable nanolayered composite.

Benefit to National Security Missions

Fossil Energy, DOD, Commerce and Transportation

If joining of bulk nanostructured metals (BNMs) is successful, this class of materials could reduce vehicle weight significantly without compromising and, perhaps, enhancing safety. These materials are lightweight, strong, and resistant to shock damage making BNMs useful in reducing weight of both civilian passenger cars and military vehicles. This reduction in weight would reduce the amount of fossil fuels needed providing more fossil energy security.

Nuclear Energy

Materials in nuclear fuel reactors experience extreme radiation and temperatures over their lifetimes. BNMs have exhibited 'self-healing' interfaces that both remove radiation damage and provide thermal stability. These interfaces would enable significantly improved safety, performance, and lifetime length for future advanced reactor and fuel cycle design.

Basic Understanding of Materials

Although it is clear that interfacial type and density control properties in BNMs, the stability of these interfaces under joining conditions has not been well-studied. Only recently has a BNM with tailored interfacial types and densities been fabricated. With this material in hand, concentrated studies on the relative stability and dynamics of various interfacial structures can commence.

Matter-Radiation Interactions in Extremes (MaRIE) Signature Facility

This study will investigate the stability of a well-controlled and well-characterized microstructure under the extreme conditions of radiation and joining. The current study will make use of ex situ characterization techniques that provide static properties. These results could form a seed study for future work at the MaRIE facility where in situ techniques could be used to manufacture specific microstructures under dynamic control.

Progress

The overall goal of the project is to study the effect of pre-existing interfacial structure on the joinability and resulting material properties of bulk nanostructured metals (BNM). Success has been achieved in fabricating strong and lightweight BNMs with industrial methods that exhibit properties that far exceed those of bulk metals through purposeful manipulation of both interfacial density and interface type. In order for BNMs to be used in engineering applications, however, the reaction of the interfacial density and interface type to industrial joining processes must be evaluated.

Over the past twelve months, the work has focused on achieving the four goals seen below and progress to this point will be described in their context.

Goal 1: Identify differences in welding parameters that can be associated with interfacial type and density

Correct tool design is of critical importance in successfully butt-welding plates of Cu-Nb nanolamellar composites with individual layer thicknesses of 200 nm. It was found that pin diameters and shoulder features needed to be redesigned from those previously successful for bead-on-plate welds of Cu-Nb nanocomposites. Within the single-pass butt-welds, a substantial decrease in equiaxed nanocrystalline grain structures (as seen in bead-on-plate welding) was noted. Further characterization is required to confirm a refined lamellar microstructure, however, this result marked the first time that a solid-state joining technique was utilized to weld metallic nanocomposites without compromising the initial lamellar microstructure.

Goal 2: Investigate stability of interfacial types and densities under the effects of joining

In the case of bead-on-plate welds, transmission electron microscopy was utilized to investigate nanocrystalline grain diameters in the refined and equiaxed weld nugget microstructure. A Lujan proposal has been submitted to extract the general texture of the weld nuggets for bead-on-plate welds in order to determine if the Nb phase causes fundamental changes in strain accommodation in friction stir welded Cu metal. In the case of butt-welded material, characterization is ongoing into determining the available interface types and densities after single-pass joining. Initial results are promising towards a refinement of the density (with the accompanying increases in strength, thermal stability, radiation tolerance, and toughness). Further work is needed to determine grain orientations and interface types that are present in butt-welded material.

Goal 3: Investigate stability of mechanical properties after joining

Mechanical properties were tested with both traditional

nanindentation and spherical Nanoindentation for bead-on-plate welds in the parent material, in the weld affected zone, and in the weld nugget. Measured hardnesses within the weld nugget for the material is 200% greater than the parent material and 20% greater than the strongest Cu-Nb multilayer composite fabricated thus far (a Cu-Nb multilayer with nominal layer thicknesses of 7 nm). This increase in strength is likely connected to the microstructural change from lamellar type structures to a nanocrystalline microstructure with grain diameters <10 nm. With a 3D as opposed to 1D nanoscale constraint, active plastic deformation mechanisms have changed leading to a significant strength enhancement. It should also be noted that the technique of spherical nanoindentation was extended to bimetallic nanocomposites for the first time in this study allowing for the extraction and confirmation of hardness, flow stress, and elastic stiffness. Current work is focused on investigating mechanical properties using the above listed techniques as well as macroscale tensile testing for butt-welded Cu-Nb plates.

Goal 4: Publicize results

Three invited talks were given by the PI at the TMS 2014 Annual Meeting, the Thermec' International Conference on Processing and Manufacturing of Advanced Materials, and the Pacific Rim Internal Conference on Advanced Materials and Processing. Three contributed talks have also been given by students who have worked on the project at other conferences.

Future Work

Over the next twelve months, the focus of the work will be on accomplishing these five tasks:

Task 1) Utilize friction stir welding to butt weld Cu-Nb nanolamellar plates of varying overall plate thicknesses and tool geometries.

Task 2) Characterize interfacial type, interfacial density and microstructure after joining to the extent possible afforded by the length scale of refinement utilizing diffraction, electron microscopy and optical microscopy.

Task 3) Utilize traditional nanoindentation and tensile testing prior to and after radiation treatments to characterize the strength of the weld.

Task 4) Submit results to a peer-reviewed journal.

Task 5) Present results in a conference talk.

Conclusion

The technical goal is to join two sheets of Cu-Nb bimetallic multilayer nanocomposites such that properties like

strength, radiation damage resistance, and thermal stability are maintained or enhanced. Joining will be attempted on Cu-Nb materials that exhibit three different interfacial types and two different interfacial densities. Through this study the relative effect of interfacial type and density on joinability can be studied as well as the stability of various interfaces under extreme strain. In addition, if joining is successful while maintaining the material properties, the last hurdle inhibiting bulk metallic nanocomposites from use as structural materials will have been overcome.

Publications

Cobb, J., S. Vachhani, R. Dickerson, P. Dickerson, W. Han, N. Mara, J. Carpenter, and J. Schneider. Layer stability and material properties of friction stir welded Cu-Nb nanolamellar composite plates. 2014. *Materials Research Letters*. 2 (4): 227.

Probing Interface Reactions of Calcite Nanocrystals at Elevated Temperatures and Pressures

Rex P. Hjelm Jr
20130772ECR

Introduction

Calcite (the most stable form of calcium carbonate, CaCO_3) is an important mineral phase in both environmental systems and energy applications. Calcium carbonate is considered the long-term sink for atmospheric carbon dioxide (CO_2), and thus the process by which CO_2 is trapped and transformed to stable carbonate minerals is of great fundamental and practical interest. The main goal of this project will be to isolate and characterize the atomic interface structures that facilitate precipitation and dissolution of carbonate species under conditions found in underground reservoirs for CO_2 sequestration.

There are many challenges to probing the relevant interface reactions experimentally: in bulk carbonate systems, the solid/fluid interface represents a very small proportion of the total system, resulting in low signal strength for many experimental measurements. Additionally, standard diffraction (the usual means of determining atomic structure) is intrinsically insufficient due to the amorphous nature of the fluid phase and the non-periodic/highly disordered interface with the solid phase. As a further complication, the sequestering of CO_2 in underground reservoirs occurs under hot, pressurized conditions. Appropriate sample environments further reduce signal from the interface. All these factors have hindered progress in experimentally probing the atomic interface structures controlling precipitation and dissolution of carbonates at crustal conditions.

We will use advanced scattering techniques based on neutron total scattering measurements to target the atomic structure at the interface between the mineral calcite (and other carbonate species) and water/carbon dioxide fluids at elevated temperatures and pressures. The approach will involve a size dependent (and therefore surface area dependent) set of carefully characterized nanocrystalline samples, high pressure and temperature sample environment development for

local structure measurements, and differential neutron total scattering measurements with fluid-solid mixtures. Along the way we will advance techniques based on neutron diffraction for characterizing the atomic structure at the interfaces of fluids and nanomaterials.

Benefit to National Security Missions

Understanding the behavior of mineral interfaces in geothermal fluids is important for expanding many of the earth's energy options, including geothermal production, hydrocarbon extraction, and geologic carbon sequestration. Successful study of the interface reactions in the $\text{CaCO}_3/\text{D}_2\text{O}/\text{CO}_2$ system directly supports the missions of reducing climate and energy impacts, and enabling environmental remediation and restoration.

Sample environment capabilities and modeling methodology developed with this work will also provide new or improved research tools for probing complex materials, relevant to the MARIE and NNSA missions of LANL and the DOE Office of Science, as well as DOE Fossil Energy, and Nuclear Energy Programs. For instance, the temperature and pressure regimes and length scales of interest in this study are directly applicable to optimizing hydrocarbon extraction from oil and gas reservoirs and understanding corrosion and scaling in nuclear reactors.

Progress

Neutron and X-ray total scattering measurements and atomic pair distribution function (PDF) analyses of several calcium carbonate crystalline polymorphs, including calcite (micron-sized bulk grains and 40 nm particles), aragonite and monohydrocalcite have been completed during the last run cycle at the Lujan Center, LANL and the Advanced Photon Source (APS), ANL. Characterization of these carbonate polymorphs provides reference structural information and model-independent local structure comparisons for the early stages of carbonate mineral growth.

Two days of synchrotron X-ray total scattering beamtime were awarded through the APS competitive proposal review process to investigate the interfacial reactions and growth of calcium carbonate minerals in controlled pore glass (CPG) substrates. The approach involves the use of well characterized CPG powders (with tunable pore wall chemistry) and a fixed chemistry of carbonate growth solution as a reasonable proxy for studying the carbonate mineral precipitation in reservoir- and cap- rock for sequestration.

The engineering design, assembly, and successful commissioning of the new NPDF fluid cell apparatus for pressure and temperature ranges up to 144 MPa and 550 K was completed in the 2013-2014 Lujan Center run cycle. High quality PDF data were collected in the apparatus for supercritical and subcritical CO₂ fluids. This result and high pressure/temperature fluid cell applications were advertised at the 2014 ACS spring meeting (March 16-20) and 2014 American Crystallography Association Annual Meeting (May 17-21) and American Conference on Neutron Scattering (June 1-6). This has resulted in a significant new sample environment for the local structure and neutron scattering community.

Future Work

Work this upcoming fiscal year will utilize our developed sample environment for in situ neutron local structure studies:

Isotherm evolution of intermolecular structure in supercritical CO₂ and CO₂/D₂O mixtures: We propose to perform in situ total scattering measurements on neat CO₂ and CO₂/D₂O mixture along an isotherm of 320K. The measured PDFs will be interpreted by direct fits with the corresponding molecular simulations and the results will also be used as the reference bulk CO₂ structures for future studies on CO₂ fluid-mineral interactions.

Probing CO₂ sorption in porous material: Monitoring the sorption mechanism and the structural characteristics of confined phases: We will complete experiments on CO₂-matrix interactions, exploring interfacial phenomena such as the wetting and adsorption for variable pore geometries or pore wall chemistry at conditions approaching/crossing into the supercritical regime. We aim to establish the nature, bonding, and density of absorbed species on SiO₂ substrate, how many fluid monolayers participate in surface processes, and how these characteristics are affected under crustal conditions suitable for geologic carbon sequestration.

Mineral formation at the surface of nano-calcite: a high pressure, high temperature local structure study: The

mineral phases of calcium carbonate are important in both natural systems and energy applications. There are six different crystalline polymorphs at ambient pressure: anhydrous phases (calcite, aragonite, and vaterite), hydrated phases, and amorphous calcium carbonates. This experiment will study the growth of calcite nanoparticles in situ at temperatures and pressures expected in sequestration environments.

Transformation of amorphous CaCO₃ during carbonate mineralization: Another neutron total scattering experiment will be completed at the NOMAD instrument at the Spallation Neutron Source, ORNL at ambient pressures. The experiment will follow the role of water on the structural stability and transformation of metastable hydrous amorphous calcium carbonate to calcite.

Conclusion

We will isolate and characterize the atomic interface structures that determine precipitation and dissolution of carbonate species under conditions found in underground reservoirs. Conversion of CO₂ into solid carbonate phases will provide the largest storage capacity within porous sandstone saline aquifers, and prevent leakage through cracks and fissures in shale and salt capping layers. Understanding the species (composition and structure), conditions (temperature and pressure), and processes involved in the formation of stable carbonate minerals will aid models in building more realistic simulations, help to predict the success of geologic repositories, and assist in identifying candidate sites for sequestration.

Publications

Wang, H. W., V. Fanelli, H. M. Reiche, E. Larson, M. A. Taylor, H. Xu, J. Siewenie, and K. Page. Pressure/temperature fluid cell for the NPDF instrument: Probing atomic structure in situ. . To appear in Review of Scientific Instruments..

Zepeda-Alarcon, E., H. Nacotte, S. Vogel, K. Page, H. W. Wang, G. King, A. Gualtieri, and H. R. Wenk. Magnetic and Nuclear Structure of Goethite alpha-FeOOH: A Neutron Diffraction Study. To appear in Journal of Applied Crystallography.

Attosecond Dynamics of Correlated Electrons in f-Electron Materials

Steve M. Gilbertson
20140622ECR

Introduction

The purpose of this project is to develop an experimental setup capable of tracking electron dynamics in correlated electron systems. The time scales involved will be on the order of attosecond (10^{-18} s). This will be the first system of its type and what we are attempting to measure will be the first observations of such dynamics. The goal of the project is to gain insight into quantum coherent electron behavior in solid state materials. The majority of attosecond experiments thus far conducted have concentrated on single atom dynamics in gases and molecules, while applications to condensed matter, especially coherent dynamics, are few. The project will focus on the measurement and first observations of quantum multi-path interference in 5f Mott insulators and 4f heavy fermion materials. The materials will be optically pumped with an infrared laser pulse and probed with a soft x-ray, attosecond laser pulse. This will enable the transient recording of the excited state dynamics. The experiments will require development of an attosecond transient reflectivity apparatus - a unique setup currently not in existence in the U.S.

The system itself will be constructed using the most cutting-edge techniques in interferometer stabilization, nonlinear optics, and state-of-the-art attosecond pulse generation methods. Such techniques have only been demonstrated a few times worldwide. Once the experimental attosecond source setup is demonstrated, materials of interest to the Department of Energy, namely f-electron systems and systems with correlated electrons, will be tested. The expected observed phenomena will be the first ever of such measurements. The data analysis will be conducted with the expertise of Los Alamos material scientists.

Benefit to National Security Missions

The specific contributions that our work makes are almost entirely in the areas of the basic understanding of materials as well as overall scientific advancement.

The work will be of particular interest to DOE/SC and the scientific discovery and innovation missions. We will be looking at the fundamental time evolution of electron dynamics within solid materials using newly developed attosecond spectroscopy techniques. The questions we can address involving correlated electrons in Mott insulators and 4-f heavy fermion materials should greatly expand the laboratory's knowledge base and will be compared to theoretical models that have been developed at LANL. The materials chosen for this work were also specifically selected to address issues pertaining to nuclear nonproliferation, and nuclear fuel research. The initial experiments will be performed on Indium-rich CeCoIn₅ which shares similar properties to nuclear fuel compounds while secondary experiments will address issues in UO₂, a known nuclear fuel product, directly. Finally, the work will address issues related to the MaRIE project. Our work will enable an important in situ characterization capability for materials that can be studied with the MaRIE facility in the future. Even more basically, the attosecond source and spectrometer that will be developed can easily be applied for studying simpler atoms, molecules and possibly even biological samples. This will provide another tool for time resolved studies in the areas of fundamental chemistry and biology.

Progress

This past year, the laser system has been upgraded to output 35 fs laser pulses with 6 mJ pulse energy. The hollow core fiber assembly has been completed and shown capable of generating broad spectra capable of supporting sub 10 fs laser pulses. The system design was completed and all of the major equipment has been purchased. As the equipment arrives, the system is being constructed. So far the optical table has been set up along with the layout for the hollow core fiber and vacuum system. The optics for the interferometer have been initially laid out and soon spatial and temporal overlap will be completed. The initial samples will be Ce and UO₂ and we have them ready to be used once the

vacuum chamber is complete.

Future Work

In the upcoming fiscal year, we plan to begin the source development during the first couple of months followed by data acquisition. The plan of the previous year was modified so that all equipment was purchased at once and up front so as to maximize the amount of time spent taking data in the second year. Since the hollow-core fiber assembly is complete as well as the upgrades for the laser system, the next step will be vacuum chamber construction and alignment of the XUV optics. This will be followed by characterization of the attosecond laser pulses via reflectivity measurements off of gold mirrors. Upon satisfactory completion of the attosecond pulse characterization, spatial and temporal overlap will be found at the location of the sample position. Once this is complete, samples that are already available will be installed for preliminary data acquisition.

Conclusion

The ultimate goal of the project is to gain unprecedented insight into quantum coherent electron behavior in solid state materials. We propose to exploit unique phenomena in 5f Mott insulators and 4f heavy-fermion materials to demonstrate quantum multi-path interference effects in the attosecond response of these materials to an infrared laser pulse. This will require development of an attosecond transient reflectivity apparatus. We will show that the application of attosecond pulses to solid state materials can provide essential information about the dynamics and coherence of electrons.

Investigating the Itinerant to Localized Crossover of the 5f Electrons in Plutonium Alloys and Compounds

Paul H. Tobash
20120736ECR

Abstract

Now more than ever, it is apparent that the 94th element in the periodic table, plutonium, offers challenges in the areas of metallurgy and physics. Perhaps the biggest question that needs to be answered is how to understand the true nature of the 5f electrons of Pu that have been shown to exhibit both itinerant (delocalized) and localized behavior. The controversy on explaining the absence of local magnetism in elemental Pu is the ultimate issue this work addresses. Electronic structure calculations have suggested the ~20% volume change from δ -Pu to α -Pu can only arise from the formation of magnetic moments (e.g. increase in lattice spacing). The experimental evidence however is not consistent with this picture where no magnetism is detected [1]. Thus, we propose to synthesize Pu binary alloys that can be directly compared to elemental δ -Pu.

Ultimately, we will be able to determine the critical compositions for a number of LANL mission-relevant binary alloys where magnetism emerges and eventually vanishes, as one moves closer to “ δ -Pu”-like compositions. After preparing these alloys, we will probe this crossover behavior by measuring their physical properties, which include magnetic susceptibility, heat capacity, and electrical resistivity. The ability to “freeze out” the complicated physics using low temperatures will be necessary in order to study electronic correlations and detect the presence of magnetism. Thermal expansion measurements will be utilized via a new low temperature dilatometry setup in order to gain insight on volume changes resulting from the presence of magnetic moments. This allows for a link into the expected pressure dependence of the materials using the Ehrenfest relationship [2]. This would be a significant part for the synergy of the experiment/theory framework of fundamental Pu physics because the invaluable input parameters for first principle band structure calculations based on Density Functional Theory (DFT) methods.

Background and Research Objectives

The duality of the 5f electrons, sometimes dubbed as “the correlated electron problem,” has its roots in Pu that resides at the boundary between the extremes of localized and delocalized behavior. As shown by Boring and Smith, the Wigner-Seitz atomic radii plotted as a function of the atomic number of the actinides, places δ -Pu at the jump between the regimes where the 5f electrons of the actinides act as metallic states (e.g. Np metal) and atomic states (e.g. Am metal). δ -Pu’s position within the family of actinides indeed shows evidence for metallic and atomic electrons where complete bonding or nonbonding states cannot entirely explain its physics. This feature becomes even less pronounced when one moves towards the metallic side where α -Pu resides and is associated with nearly a 25% reduction of the unit cell volume per atom. This larger unit cell volume of δ -Pu is often suggested to arise from the emergence of magnetic moments present there. However, the recent work by Lashley and co-workers shows no evidence for localized magnetic moments as suggested from magnetic susceptibility studies. Indeed, the crossover of magnetic to nonmagnetic behavior is very clear with the gamma to alpha transition in Ce, sometimes envisioned as a “surrogate” to Pu, where the volume changes by an almost comparable 17%. This transition, which is characterized as a Mott-like transition, is easily associated with a noticeable change in the magnetic susceptibility moving from temperature-dependent Curie-Weiss behavior (γ -Ce) to a small nearly temperature independent behavior (α -Ce). The problem is that the crossover in Pu is not as straightforward and therefore must be tracked more systematically in closely related Pu-rich alloys that are expected to show localized magnetism. Indeed, there have been a number of suggestions to explain this absence of magnetism in Pu such as Kondo shielding arguments where the conduction electrons begin to screen the magnetic moments or electron pairing correlations where itinerant states appear but the true nature of the 5f’s remain unclear.

The presence of magnetism can also be tracked from thermal expansion measurements at low temperatures where magnetism is expected to occur. Since the presence of magnetism is related to a localized (or nonbonding) configuration of 5f electrons, dilatometry can be a very sensitive probe to measure the lattice expansion associated with the incipient magnetic moments. Once we obtain the change of the thermal expansion coefficient, we can estimate the expected pressure derivative for the 2nd order phase transition using the Ehrenfest relationship written as $dT_{crit}/dp = [(V_m \Delta \alpha_i T_{crit}) / \Delta C_p]$ where V_m is the molar volume, $\Delta \alpha_i$ is the change in the volume thermal expansion coefficient, and ΔC_p is the change of the specific heat at the transition. A negative value from this relation indicates that the ordering temperature should decrease with increasing pressure (smaller molar volume), where a positive value indicates that the ordering temperature should increase with pressure. To a first approximation, we may suggest that the nonmagnetic smaller Pu²⁺ configuration (5f⁶) compared to the magnetic and larger Pu³⁺ (5f⁵) would be favored under pressure. This situation would move into the left side of the Doniach diagram where Kondo interactions (TK) would screen magnetism and therefore dominate the coupling of magnetic moments (RKKY).

Scientific Approach and Accomplishments

The aim of this project is to understand LANL relevant binary alloys at a fundamental level. This includes having the ability to synthesize bulk and high purity samples either in single crystalline or polycrystalline form. Once these samples are satisfactorily made then the study of their physical properties can be carried out. We will now be subjecting these already synthesized materials to numerous measurements all of which are spelled out in the project as well as many addition ones (future collaborations at LANL and outside). These are highly motivated experiments due to the availability of the samples and of which have not been subjected to detailed characterization studies at least in the last decade or more. Due to the rarity of having these samples available to fellow LANL colleagues as well as offsite collaborations, we plan to make available various amounts of these materials dedicated for future measurements.

As to date, we can make samples of PuX₃ and Pu₃X as well as the newly studied Pu₆Fe that were all targeted in the project. The purity of Pu₃X still warrants some work in possibly introducing longer annealing times but after our diffraction measurements we plan to measure magnetic susceptibility in order to see where the magnetic ordering temperature occurs. They will later be used in the newly assembled low temperature dilatometer that will be utilized to further confirm this onset of magnetic order. The

list below shows the significant milestones to date in the project:

- Two capabilities set up during project (capacitance dilatometry and induction melting)
- Pure samples of PuX₃ synthesized and characterized (single crystals!)
- Pu₃X reactions (Ga) working on phase purity and measurements (annealing efforts of polycrystalline samples end of December)
- First heat capacity and electrical resistivity measurements on δ -Pu 7at%Ga (baseline material)
- A sample of bulk Pu₆Fe has been made
- Electronic structure calculations were completed on PuIn₃, PuSn₃, and Pu₃X
- Presented some of this work at XIII International Workshop – Fundamental Properties of Plutonium (Sarov, Russia) and will present at Pu Futures in 2014
- External measurements on PuSn₃ (XES)
- Developed encapsulation for low temperature Pu thermal expansion (capacitance dilatometry)
- Investigating an additional thermal expansion technique demonstrated on PuRhIn₅ and PuCoGa₅ (Marcelo Jaime, Ross McDonald, Mark Wartenbe) – Fiber optic gratings

For the success of this project, several binary compounds need to be synthesized and will further be subjected to fundamental studies in order to shed light on understanding the “Pu problem” in condensed matter physics and the reason why magnetism is so hard to detect in the α -Pu and δ -Pu allotropes. This study therefore requires an array of samples for these future studies such as ARPES and XAFS. As explained earlier in the report, the phase space between the end members of the “Pu-lean” composition such as PuX₃ and the “Pu-rich” Pu₃X including δ -Pu will help probe these questions. This project was meant to provide a fundamental understanding and lay the necessary groundwork for further more systematic and detailed Pu alloy work that is of immediate interest to LANL.

The structure of PuX₃ is cubic and its crystallographic arrangement can be seen in Figure 1. These compounds crystallize with the cubic space group Pm-3m No. 221 [3]. In this structure, the Pu atoms are located at the corners of the primitive unit cell as shown in Figure 1, in which cuboctahedra PuX₃ blocks form a 12-membered polyhe-

dron of the X atoms around a central Pu atom. With the Pu atoms located at the corners of the primitive unit cell, the X atoms form six-membered octahedra centering this unit cell. This building block forms the basis for a number of related $\text{Pu}_n\text{MmX}_{3n+2m}$ compounds. The crystal structure of Pu_3X is the same as the PuX_3 compounds however the crystallographic sites are reversed. As shown in Figure 1, now the Pu atoms form the six-membered octahedral and the X atoms are located at the corners of the primitive unit cell. With the different X atoms in the Pu_3Ga , Pu_3In , and Pu_3Sn structures these Pu-Pu bonding contacts will change and measure on the order of 3.327 Å in Pu_3In , 3.192 Å in Pu_3Ga , and 3.345 Å in Pu_3Sn . All of these distances are close to those found in δ -Pu which measure 3.276 Å and therefore make an ideal study for structure/property comparisons.

The data shown in Figure 2 compiles the measurements done on the PuX_3 compounds up to date. The PuIn_3 compound shows an anomaly at $T_N = 14.5$ K and signals the onset of magnetic order. A fit to the data above the ordering temperature yields an electronic specific heat $\gamma = 307$ mJ/mol K² that suggests a large effective mass along with a Debye temperature of $\theta_D = 186$ K. The two PuGa_3 compounds (one with hexagonal symmetry and the other with trigonal symmetry) show peaks corresponding to magnetic order. These show up at $T_N = 24$ K and $T_C = 20$ K. Both of the compounds have enhanced Sommerfeld coefficients of 100 mJ/mol K² (trigonal PuGa_3) and 199 mJ/mol K² (hexagonal PuGa_3). The PuSn_3 compound synthesized in single crystalline form shows no indication for long-range magnetic order down to 2 K and also has a very small Sommerfeld coefficient from specific heat corresponding to about 13 mJ/mol K² [4]. Lastly, the specific heat data of the δ -Pu sample that was used as “baseline” material for our measurements is depicted in Figure 2. As can be seen, it scales very nicely with the other compounds at low temperature and yields a Sommerfeld coefficient of 48.5 mJ/mol K² along with a Debye temperature of 113 K.

Measurements on the Pu_3X compounds will be finalized when the samples are finished annealing (we have discovered from this project that the annealing times can be on the order of a month or more). We will later cool the physical property measurement system for the subsequent measurements. This will also include the newly assembled thermal expansion setup. This setup is discussed later on in the report.

The powder pattern for Pu_3Ga is shown in Figure 3a. This compound is critical for an understanding of the expected magnetism in the compound that was reported earlier by our Russian colleagues. Figure 3a shows the raw data collected after the 1 month anneal on the Pu_3Ga was com-

plete. This sample was prepared from the newly installed induction furnace in the CMR facility. The sample was wrapped in Ta foil and heated to 500 oC where it was allowed to dwell for 1 month. The data indicates that the compound was formed but also some peaks belong to an unwanted Pu oxide side product. Due to the similarity of the binary phase diagrams for the Pu-X compounds targeted in the project, the same experimental conditions are used on the Pu_3In and Pu_3Sn compounds. Results for these compounds are still pending analysis. As can be seen from the “Pu-rich” phase diagram in Figure 3b, we have laid the groundwork for some further studies including synthesizing other compositions to fill in the gap in the relatively unknown phase space. This will allow for a systematic way to track the structure/property relationships in the binary system of alloys to be made in the future. We also plan to characterize several samples relevant to this project that were obtained from an AWE collaborator (David Wheeler). These measurements are scheduled to happen in the next coming months.

Another aspect of the project that we provide results for are the targeted electronic structure calculations for the compounds. These results are summarized in Figure 4. As can be seen in Figure 4a, the band structure plots for PuIn_3 and PuSn_3 compounds are very different [5]. This is expected due to the different magnetic properties of both compounds (PuIn_3 shows antiferromagnetic order while PuSn_3 shows temperature independent paramagnetic behavior). The band structure plots provide information on the strength of the hybridization between the Pu 5f and the ligand p states that will help in better understanding the delocalized/localized nature of the Pu 5f states. In PuSn_3 , the Fermi surface topology shows no clear indication for surface nesting which might explain the absence of magnetism in the compound. In PuIn_3 , the Fermi surface topology shows nesting and therefore the magnetic instability for antiferromagnetic order should be favored. This is indeed true because from our specific heat measurements we observe antiferromagnetic order at 14.5 K. For the Pu_3X compounds (Figure 4b) first-principles calculations were completed to determine the electronic density of states. Since there is hybridization not only between the Pu 5f and 6d states but also between the Pu 5f and ligand p states, it was determined that the latter hybridization controls the effective band width of the 5f states with Pu_3Sn being the least delocalized [6].

One final aspect of the project was to develop the low temperature dilatometer to be used to measure thermal expansion of Pu alloys. This device was assembled and is working [7]. It can be seen in Figure 5. The setup utilizes capacitance dilatometry to measure the thermal expansion

of the synthesized Pu alloys and compounds. It will work from the large temperature range of 300 K to 2 K and is designed to safely fit into a commercial available property measurement system from Quantum Design. A G10 sleeve is also used in order to work safely with actinide materials and stop the risk of contaminating the sample chamber. The sample cell can accommodate a range of sample sizes and geometries. For data collection, the capacitance is recorded off an Andeen Hagerling 2550A Single-Frequency Ultra-Precision Capacitance Bridge and the temperature is recorded from a Cernox 1030 thermometer from Lakeshore Cryotronics along with a Neocera temperature controller. Everything is recorded into a Labview program and can be read from a simple ASCII data file for plotting and analyzing the data. The setup is working and will be used to measure the thermal expansion of the alloys once the characterization is complete. This data will then be used to estimate the expected pressure derivatives of the samples that can be obtained from the Ehrenfest relationship and using the already obtained specific heat data.

Impact on National Missions

The close relationship this project has to the new “Integrated Pu Science and Research Strategy” positions it as a significant area of research and high payoff for LANL and NNSA missions. The low temperature dilatometer represents an important new capability in our toolbox to better elucidate Pu physics and the approach is applicable to other important materials such as lanthanides.

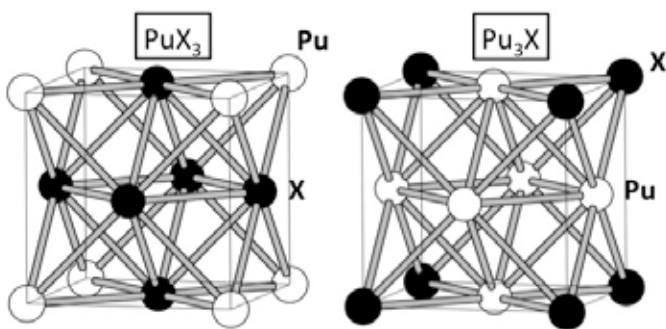

Figure 1. The crystal structures of the cubic PuX_3 and Pu_3X compounds. Notice the similarities of both structures that have X atom octahedral and Pu atom octahedral respectively. The unit cell is depicted with solid lines in both structures.

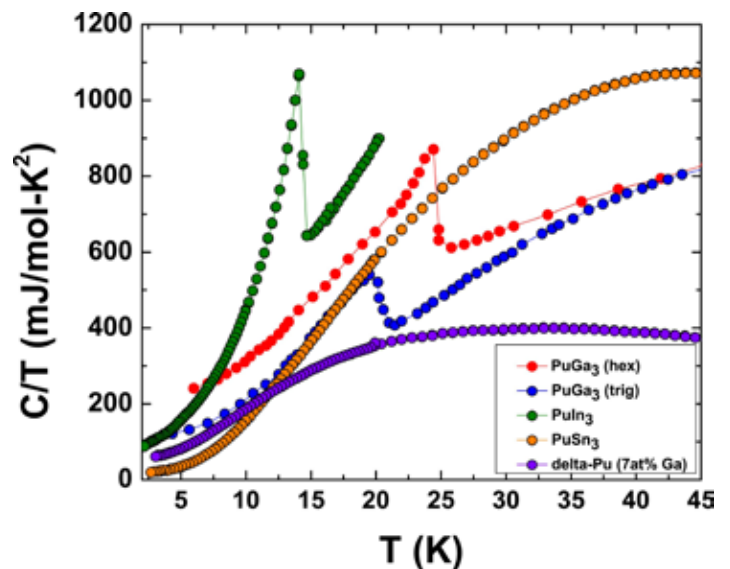

Figure 2. The specific heat data for the PuX ($X = Ga, Sn, In$) and δ -Pu (7at%Ga) samples plotted as C/T vs. T . The occurrence of magnetism is confirmed from the strong anomaly in the C/T data.

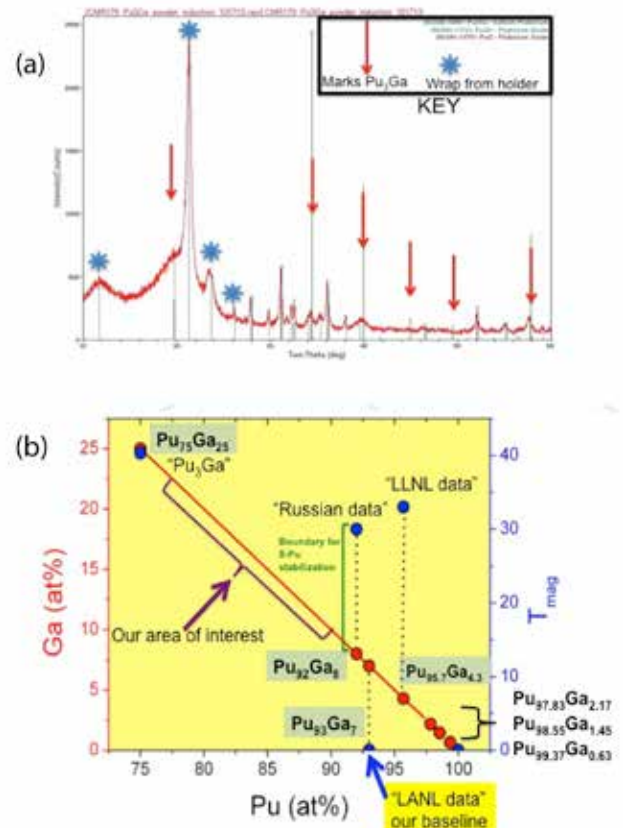

Figure 3. (a) The X-ray powder diffraction pattern for the synthesized PuGa after annealing for 1 month. The red arrows indicate the expected Bragg peaks corresponding to the cubic symmetry. The peaks marked by blue stars are from the sample holder. (b) The Pu-Ga phase space from 75at%Pu to pure Pu.

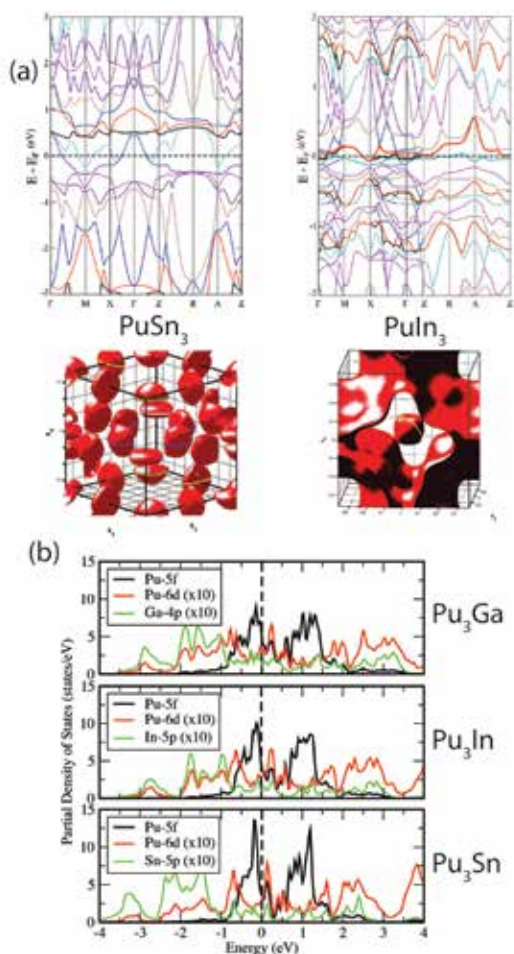

Figure 4. The band structure plots for PuSn_3 and PuIn_3 along with their respective Fermi surface plots below each. (b) The electronic density of states for the Pu-rich Pu_3Ga , Pu_3In , and Pu_3Sn . The plots show the Pu-5f, Pu6d, and X-4p or 5p hybridization.



Figure 5. The assembled low temperature dilatometer to measure thermal expansion. The design was based off of the model proposed by Schmeideshoff [7]. The G10 sleeve allows for an encapsulated setup for measuring actinide materials safely in the physical property measurement system (PPMS).

References

1. Lashley, J. C., A. Lawson, R. J. McQueeney, and G. H. Lander. Absence of magnetic moments in plutonium. 2005. *PHYSICAL REVIEW B*. 72 (5): -.
2. Barron, , and White, GK. Heat Capacity and Thermal Expansion at Low Temperatures. 1999.
3. Bauer, E. D., P. H. Tobash, J. N. Mitchell, and J. L. Sarrao. Single crystal growth of plutonium compounds from molten metal fluxes. 2012. *PHILOSOPHICAL MAGAZINE*. 92 (19-21): 2466.
4. Tobash, P., J. Mitchell, and E. Bauer. Synthesis and Properties of PuSn_3 . 2014. *Journal of Physics and Condensed Matter*.
5. Wang, C. C. J., M. D. Jones, and J. X. Zhu. Fermi surface topology and de Haas-van Alphen orbits in PuIn_3 and PuSn_3 compounds. 2013. *PHYSICAL REVIEW B*. 88 (12): -.
6. Tobash, P., J. Zhu, J. Mitchell, and E. Bauer. The Pu-rich Pu_3X Compounds. 2014. *Journal of Physics and Condensed Matter*.
7. Schmedeshoff, G. M., A. W. Lounsbury, D. J. Luna, S. J. Tracy, A. J. Schramm, S. W. Tozer, V. F. Correa, S. T. Hannahs, T. P. Murphy, E. C. Palm, A. H. Lacerda, S. L. Bud'ko, P. C. Canfield, J. L. Smith, J. C. Lashley, and J. C. Cooley. Versatile and compact capacitive dilatometer. 2006. *REVIEW OF SCIENTIFIC INSTRUMENTS*. 77 (12): -.

Publications

- Bauer, E., P. Tobash, J. Mitchell, and J. Sarrao. Single crystal growth of plutonium compounds from molten metal fluxes. 2012. *Philosophical Magazine*. 92 (19-21): 2466.

3-Dimensional Characterization of Nuclear Fuels: Microstructural Evolution under Representative Temperature and Thermal Gradients

Donald W. Brown
20130232ER

Introduction

Recently, interest in nuclear energy in the United States has surged with increased efforts to extend the lifetime of the current fleet of reactors and to develop advanced reactors which operate at higher temperatures and use fuel to higher burn-up. Safety margins and predictions of the engineering performance of nuclear reactor fuel rely on modeling codes used to predict dimensional change, stress state and fission gas release as a function of burn-up and temperature history. Thermal conductivity is the single most important material parameter in these codes and is heavily dependent on microstructure e.g. grain morphology, porosity, etc. To date, empirical and phenomenological descriptions of the evolution of the microstructure of fuel materials are used to calculate the thermal conductivity, but this leaves huge uncertainties and necessarily results in large safety margins and inherently inefficient use of resources as well as increased production of waste.

The goal of the proposed research is to advance the understanding of the microstructural evolution of nuclear fuel materials under conditions simulating those perceived during manufacture and in-pile. Specifically, we will monitor grain morphology, pore migration, chemical segregation, and fission gas transport in nuclear fuels under processing temperatures ($\sim 1650^\circ\text{C}$) and under service conditions (thermal gradient of $1000^\circ\text{C}/5\text{mm}$). Toward this end, we will develop high energy synchrotron x-ray techniques for characterization of fuel under representative temperature conditions. These techniques provide a non-destructive means to monitor the evolution of fuel microstructure under representative conditions. The results will be used by researchers across the nation working on multi-length scale modeling of ceramic nuclear fuels.

Benefit to National Security Missions

The work is directly relevant to DOE NE (nuclear energy) in that it provides data that will be used to validate com-

putational models which are currently being developed as part of DOE NE. It will advance the field of ceramic nuclear fuels specifically, and ceramics in general. The development of the technique is directly relevant to the Materials and Radiation Interaction in Extremes (MaRIE) project in that one would imagine every sample run in the multi-probe diagnostic hall (MPDF) first being characterized with the high energy diffraction microscopy (HEDM) developed herein. This technique development is particularly relevant to the nuclear stockpile mission in that it will focus on specific advances necessary to study high-Z number materials with x-ray diffraction and tomography.

Progress

An invited talk was given at the MECA SENS (Mechanical Evaluation of Stress Using Neutron and Synchrotron X-ray Scattering techniques) in Sydney Australia and proceedings published in Materials Science Forum. Also, the PI was invited to brief DOE-NE on the project, opening the doors for future programmatic funding. The presentation was very well received. Further, a seminar was given to the Nuclear Energy group at Argonne National Lab which will result in future collaboration (they will provide samples for future measurements) and they have requested help in building the science case for XMAT, a beam line designed for in-situ ion irradiation of materials.

Collaborations have also been initiated with Mike Tonks at INL. At his request, we sent data representing an observed microstructure. They have generated a virtual microstructure which can be interpreted by the MAR-MOT code. They are awaiting our in-situ experiments in July/August. Once complete, we will supply them with the run conditions (e.g. time and temperature). They will model the evolution of the virtual microstructure under identical conditions using our observed microstructure evolution as direct validation of the simulation. This is a level 2 milestone for the NEAMS program. Also, we were

invited to be part of an EFRC proposal on similar work. Unfortunately, that was unsuccessful.

In terms of measurements, we have collected and analyzed data on three Urania samples with different oxygen content, UO₂, UO_{2.11}, and UO_{2.16}. We have observed that the grain development during sintering depends on the O content. This result is currently being written up for publication. Also, we completed SANS (Small Angle Neutron Scattering) during interrupted sintering of a green UO₂ pellet. Microstructural evolution is obvious in the data, which is currently being analyzed and will be presented at NuMat in October. A proposal has been submitted for in-situ sintering in the next Lujan run cycle. This data has garnered interested from the DOE fuels program lead (Ken McClellan) and a collaboration with Japanese researchers on aged fuel is in the works.

We have been granted beamtime for 3 experiments in the summer of 2014, 2 HEDM experiments at Diamond (UK) and the APS (Chicago) on UO₂ at temperature and a SAXS measurement on IBAD (ion bombardment assisted growth) samples which have been impregnated with Xe. The UO₂ samples are ready. The high temperature furnace has been demonstrated and control issues are being rectified. The first of the IBAD samples are complete. We are in discussions with the safety committee at APS for the high temperature measurements.

These results are consistent with the milestones for this project at this time.

Future Work

- Analyze grain boundary statistics from ex-situ HEDM experiments. Submit abstract for presentation at topical conference in FY14.
- Prepare and submit journal article on pore development during sintering of UO₂ from tomography and SANS data.
- Produce grain maps from HEDM data collected in-situ. Analyze grain boundary statistics from ex-situ HEDM experiments.
- Analyze x-ray fluorescence data.
- Analyze grain boundary statistics from ex-situ HEDM experiments. Submit abstract for presentation at topical conference in FY14.
- Perform x-ray fluorescence measurements of fission gas products (Xe and Kr) to grain boundaries at temperature.

- Prepare and submit journal article on grain boundary segregation of Xe and Kr.
- Prepare and submit journal article on grain morphology evolution in UO₂ in a gradient.

Conclusion

This experimental work will provided the nuclear fuel theoretical community with unprecedented information concerning the microstructural evolution of fuels during usage. We will not only recognize that the grain structure of a ceramic fuel evolves during use, but will also determine kinetics and mechanisms for said motion of the grain. We will understand preferential segregation of fission products to specific grain boundary types. This data will be used by the fuel modeling community represented, for instance by the CASL (Consortium for Advanced Simulation of Light Water Reactors) at LANL, to both drive model development and validate existing models.

Publications

Brown, D. W., Balogh, Byler, C. M. Hefferan, J. F. Hunter, Kenesei, S. F. Li, Lind, S. R. Niezgod, and R. M. Suter. Demonstration of Near Field High Energy X-Ray Diffraction Microscopy on High-Z Ceramic Nuclear Fuel Material. 2014. MECHANICAL STRESS EVALUATION BY NEUTRONS AND SYNCHROTRON RADIATION VII. 777: 112.

Very Low Temperature Scanning Point Contact Spectroscopy Investigation of Inhomogeneous States on the Nano-scale

Roman Movshovich
20130285ER

Introduction

We will combine our expertise in several Scanning Probe Microscopy (SPM) and Spectroscopy (SPS) techniques and a dilution refrigerator instrumented with a 14 Tesla magnet to develop a novel Low Temperature Scanning Point Contact Spectroscopy (LTSPCS) apparatus. Point Contact Spectroscopy (PCS) has been used extensively for investigating homogeneous superconducting (SC) states in zero magnetic field. Our LTSPCS apparatus will go well beyond this: a sub-nm resolution of the PCS combined with the scanning capability and in-situ control of the force between the PCS tip and the sample, combined with high magnetic field, and very low temperatures environment, will allow us to explore the spatially inhomogeneous states in an unprecedented phase space. Within this proposal we will address some of the hottest topics in correlated electron physics, among them (1) spatial variation of the energy gap in the postulated Fulde-Ferrell-Larkin-Ovchinnikov superconducting state in CeCoIn₅, and (2) direct visualization of the high field vortex structures, up till now studied only by Small Angle Neutron Scattering (SANS) techniques, in e.g. CeCoIn₅ and UPt₃. Our LTSPCS apparatus will be developed on the basis of the combination of techniques and components adapted from a number of different scanning probes, such as a unique all metal tip cantilever (based on cantilevers used for Scanning Tunneling Microscopy (STM)), and fiberoptic interferometry employed in conventional Magnetic Force Microscopy (MFM) and Atomic Force Microscopy (AFM). The experimental part of this project will be complimented by advances in the theoretical understanding of the details of the FFLO state (especially at the surface), and a substantial increase in our capabilities to model point contact spectroscopy of heavy-fermion superconductors. The unique combination of achieved capabilities will open a new era of correlated electron research at very low temperatures and high fields, and help assure the preeminent position of LANL in this field.

Benefit to National Security Missions

This project addresses the Grand Challenge: "Materials: Discovery Science to Strategic Applications". It creates new measurement and modeling capabilities in materials science for superconductivity and f-electron physics. The VLTSPCS will ensure LANL's position of leadership in the area of correlated electron research. It will be directly applicable to investigations of heavy fermion physics, an area of traditional strong interest at LANL due to its focus on f-electron elements, especially the actinide series. Overall, this project supports both themes of Emergent Phenomena and Defects and Interfaces, two of the three areas of the Materials Strategy at LANL. The VLTSPCS will open up avenues for new program development based on the multi-component suite of the Scanned Probes. John Sarrao, former Office of Science Programs Director and MaRIE Capture Manager, is cognizant of the proposed research.

The experimental part of this project cannot be successful without advances in the theoretical understanding of the details of the FFLO state (especially at the surface), and a substantial increase in our capabilities to model point contact spectroscopy of heavy-fermion superconductors. The developed modeling capabilities will allow the interpretation of measurements within this project, and apply to other correlated electron systems as well.

Progress

Within the experimental part of the project the focus was on developing expertise of a postdoc hired in December 2013 in operation of the Magnetic Force Microscope (MFM), as Scanning Point Contact Spectroscopy (SPCS), the goal of the proposal is borrows heavily from MFM. We made several significant modifications to the MFM apparatus that allows better temperature control of the sample. Several of the indium seals in the adapter flanges were re-done, to resolve the problems with the leaks that plagued the apparatus in previous investigations. Neliza Leon-Brito, a postdoc hired on the project

in December 2013, is acquiring expertise in running our MFM apparatus. She has performed magnetic field penetration depth measurements in several superconductors, and obtained images of domains in a ferromagnet as part of her training.

Within the theoretical component of the project within the past year we accomplished the following:

Spectroscopy and the evolution of quasiparticle states with and without a Zn impurity in doped 122 iron pnictides

Based on the minimum two-orbital model and the phase diagram recently proposed by Tai et al. (Europhys. Lett. 103, 67001(2013)) for both electron- and hole-doped 122 iron-based superconducting compounds, we used the Bogoliubov-de Gennes equations to perform a comprehensive investigation of the evolution of the Fermi surface (FS) topology in the presence of the collinear spin-density-wave (SDW) order as the doping is changed. In the parent compound, the ground state is the SDW order, where the FS is not completely gapped, and two types of Dirac cones, one electron-doped and the other hole-doped emerge in the magnetic Brillouin zone. Our findings are qualitatively consistent with recent angle-resolved photoemission spectroscopy and magneto-resistivity measurements. We also examined the FS evolution of both electron- and hole-doped cases and compared them with measurements, as well as with those obtained by other model Hamiltonians.

Development of two-channel tunneling model for normal metallic tip and heavy-fermion superconductor

We introduced a two-channel tunneling model to generalize the widely used BTK theory of point contact conductance between a normal metal contact and superconductor. Tunneling of electrons can occur via localized surface states or directly, resulting in a Fano resonance in the differential conductance $G = dI/dV$. We presented an analysis of G within the two-channel model when applied to soft point-contacts between normal metallic silver particles and prototypical heavy-fermion superconductors CeCoIn₅ and CeRhIn₅ at high pressure. In the normal state the Fano lineshape of the measured G is well described by a model with two tunneling channels and a large temperature independent background conductance. In the superconducting state a strongly suppressed Andreev reflection signal is explained by the presence of the background conductance. We reported Andreev signal in CeCoIn₅ consistent with standard dx^2-y^2 -wave pairing, assuming an equal mixture of tunneling into [100] and [110] crystallographic interfaces. Whereas in CeRhIn₅ at 1.8 and 2.0 GPa the signal is described by either an s -wave or dx^2-y^2 -wave gap with reduced nodal region, i.e., increased slope of the gap opening on the Fermi surface. A possibility is that the shape of

the high-pressure Andreev signal is affected by the presence of the coexistence phase between superconductivity and antiferromagnetism and the proximity of a quantum critical point near 1.75 GPa which is not accounted for in our description of the heavy-fermion superconductor.

Development of tunneling model for correlated electron tunneling model within the slave-boson mean-field approximation

We have begun incorporating electronic correlation effects into the Hamiltonian describing the correlation effects between itinerant electrons and localized f -electron states when probed by scanning tunneling and point-contact spectroscopies. In our previous calculations and data analysis we found that the interplay of magnetism and superconductivity as well as the interaction between itinerant and localized states can significantly alter the lineshapes of spectra and thus need to be included on equal footing for predictive model calculations. We are improving the tunneling model to result in better agreement with observed phases in heavy fermion superconductors like CeCoIn₅.

Future Work

Within the experimental part of our project, during the fiscal year our goal to continue developing of expertise in operation of Magnetic Force Microscope (MFM) (we have hired a new postdoc in December 2013) and to demonstrate operation of the Scanning Point Contact Microscope (SPCM) at 4K, substituting a metallic cantilever for a magnetic cantilever in an existing 4 Kelvin MFM apparatus. We will demonstrate the scanning capability of our device on NbSe₂; image the superconducting vortex (spatial variation of the energy gap) and vortex lattice with the SPCM.

Within the theoretical part of our project will incorporate electronic correlation effects into the Hamiltonian describing the correlation effects between itinerant electrons and localized f -electron states when probed by scanning tunneling and point-contact spectroscopies. We will include the interplay of magnetism and superconductivity as well as the interaction between itinerant and localized states to improve the tunneling model that will lead better agreement with observed phases in heavy fermion superconductors like CeCoIn₅.

Conclusion

We will develop new experimental capability of Very Low Temperature Scanning Point Spectroscopy, together with theoretical modeling support, to image the superconducting energy gap on the sub-nm scale, at temperatures down to few tens of mK, and fields up to 14 T. Visualization of the spatial variation of the superconducting energy gap in CeCoIn₅ will settle the controversy of whether the High

Field Superconducting (HFSC) phase is a realization of the FFLO state, predicted theoretically in 1960's, or an exotic field-induced magnetic state. We will directly image the vortex lattice of CeCoIn₅ and explore its rich and exotic phase diagram.

Publications

Chen, H., Y. Y. Tai, C. S. Ting, M. J. Graf, D. Jianhui, and J. Zhu. Disorder effects in multiorbital s(+/-)-wave superconductors: Implications for Zn-doped BaFe₂As₂ compounds. 2013. PHYSICAL REVIEW B. 88 (18): 184501.

Fogelstrom, , M. J. Graf, V. A. Sidorov, X. i. n. Lu, E. D. Bauer, and J. D. Thompson. Two-channel point-contact tunneling theory of superconductors. 2014. PHYSICAL REVIEW B. 90 (10).

Kim, , Haberkorn, Kim, Civale, P. C. Dowden, and Movshovich. Ferromagnetic bubble clusters in Y_{0.67}Ca_{0.33}MnO₃ thin films. 2013. APPLIED PHYSICS LETTERS. 102 (19).

Kim, J., N. Haberkorn, K. Gofryk, M. J. Graf, L. Civale, F. Ronning, A. S. Sefat, and R. Movshovich. Intrinsic superconducting properties and vortex dynamics in heavily overdoped Ba(Fe_{0.86}Co_{0.14})₂As₂ single crystal. To appear in Solid State Communications.

Pan, , Li, Tai, M. J. Graf, Zhu, and C. S. Ting. Evolution of the Fermi surface topology in doped 122 iron pnictides. 2013. PHYSICAL REVIEW B. 88 (21).

Excited State Quantum Interactions in Carbon Nanotubes

Stephen K. Doorn
20130309ER

Introduction

Our recent first-time demonstration of quantum interference and violation of the Condon approximation in carbon nanotubes (CNTs) overturns long-held assumptions regarding their optical response and opens the way for new quantum physics to be explored in these systems. While these fundamental behaviors are fascinating by themselves, they have the potential to alter relaxation pathways and dynamics underlying anticipated applications in photonics, optoelectronics and energy harvesting. It is therefore important to understand both the origins and consequences of these phenomena in CNTs. Our goal is to understand how the interplay of electronic and vibrational structure in CNTs gives rise to non-Condon and interference behaviors and determine what consequences they hold for observed photophysical responses. We focus on three objectives:

Non-Condon Behaviors will be probed for multiple nanotube structures, vibrational modes, and excited states using Raman and modeled with quantum chemical theory to gain an understanding of their origins. Dynamic perturbation of CNT structure will further inform on their origins and reveal routes to control the effect.

Dynamic Control of Quantum Interference by strain tuning of the electronic energy spacings that determine interference will allow us to sample all possible interference behaviors while using interference response to probe consequences for underlying photophysical behaviors.

Relaxation Pathways and Dynamics will be probed using time-resolved spectroscopies to learn the fate of optical excitations as determined by phonon-mediated electronic state interactions.

Each of these focal areas represents pioneering studies that will open significant new areas of CNT physics for further investigation. No other molecular or condensed-matter system offers the ability to study non-Condon

and interference behaviors in such a controlled and systematic way and the information gained here will impact understanding of photophysical behaviors of broad classes of optical materials and serve as a bridge between molecular and condensed matter systems.

Benefit to National Security Missions

Results of this project will have a direct bearing on developing optical and electronic properties of carbon nanotubes for photonic and energy harvesting applications and may also contribute to sensing and spectral tagging applications. As a result this work will have direct relevance to the mission of the DOE-BES funded Center for Integrated Nanotechnologies and the potential applications will be of interest to agencies including NIH, DOE, DHS, and DOD with potential impact on threat reduction and renewable energy missions. Our effort will also drive development and understanding of fundamental surface chemistry of low-dimensional materials. Additionally, the quantum behaviors we will study are found in broad classes of materials, but only carbon nanotubes allow the detailed study that will be pursued in this effort. As a result, the nanotubes serve as ideal model systems for obtaining a basic understanding of several novel quantum behaviors. As such, their study supports DOE goals for expanding fundamental understanding of functional nanomaterials.

Progress

Generation of targeted nanotube structures: Separations advances

To meet our remaining goals, advances in nanotube separations needed to be made that provide specific new chiralities while efficiently generating large quantities (mL scale) of enriched material. We established a new technique based on aqueous two-phase separation concepts that allows rapid separation and efficient scale-up of targeted chiralities. We now have on hand 10+ mL scale volumes of new armchair species ((8,8), (6,6), and (5,5)), for metallic studies, advances in large-diameter

separations (particularly difficult range giving (10,5), (10,2), (12,4) for pump probe and interference studies), novel non-armchair metallics ((10,4), (7,4)) for interference work and (7,5) and (7,6) for our strain-modulation studies and work on isotopically substituted tubes. The separations work has resulted in one published paper and another in preparation.

Non-Condon Behavior in Armchair (n,n) Structures

With our advances in separations we had the opportunity to significantly expand and improve the quality of our Raman excitation profile (REP) data. We now have REPs for 4 structures ((8,8), (7,7), (6,6), (5,5); diameter of 0.68 to 1.09 nm). In all cases significant REP asymmetry is demonstrated, extending our observed trends to metallic tubes and further cementing our finding the behavior is intrinsic. The high quality of the new REPs allows us to now definitively demonstrate asymmetry weakens as diameter decreases.

Through a collaboration with Eduardo Barros of MIT, we now also have a path to a theoretical description of the REP behaviors. We have demonstrated that, while a competing condensed-matter theory can describe our diameter-dependent trends, it is inadequate to describe the magnitude of the asymmetries. As an alternative we have developed a description that combines molecular concepts with condensed matter that describes the asymmetries via a state-mixing approach. The flexible approach is general to semiconductors (see below). It remains a challenge, however, to describe which nanotube states are responsible for the non-Condon effects. A revised manuscript on these results is in preparation.

TO Phonon Frequency Anomaly in Armchairs

The armchair work has allowed us to obtain the first ever detailed frequency values for the TO phonon mode over 6 different structures. Frequencies show a sharp decrease to smaller diameter tubes and exhibit anomalous behavior of the phonon dispersion. The behavior can be described by introducing a new phonon scattering mechanism in nanotubes. We have confirmed this mechanistic description by recently completing a second round of electrochemical doping measurements on pure (6,6) structures in our armchair series. Our results now resolve a controversy in the theoretical community over how to describe electron-phonon coupling in metallic nanotubes. A manuscript describing the results is nearly ready for submitting to Phys. Rev. B.

Transition Energy Dependence of REP Asymmetry in Semiconductors

We have already established REP asymmetry in semiconductors for a wide range of chiralities across the first 4 exciton excited states. A theoretical description has been lack-

ing, but as an extension of the work on armchair structures we have demonstrated the generality of the condensed matter state-mixing approach to non-Condon modeling to include the semiconductor structures. Of significance, we demonstrate the excitonic nature of the optical transitions plays a significant role in the origins of the behavior. While state-mixing surprisingly might evolve from the strongest allowed excitonic transitions. The modeling results are converging on a description that involves mixing of weakly allowed states associated with phonon sidebands. The theory is beginning to have predictive power and suggests that isotopic substitution should modulate the observed asymmetries. To test this prediction we now have C13 isotopically substituted nanotubes and have shown we can isolate (7,5) and (7,6) structures from the samples on which to perform REP measurements.

Excited State Dynamics

In the theoretical modeling we focused on quantum chemical calculations of cycloparaphenylenes, the simplest structural unit of armchair carbon nanotubes. Our time-dependent density functional theory study provides a simple and conceptually appealing physical picture explaining all experimentally observed trends in optical properties in this family of molecules. We found that the commonly used Condon approximation is invalid in this molecular family and breaks optical selection rules, making these materials superior fluorophores. The results are guiding pump-probe experiments, with first measurements indicating ground state recovery dynamics. New samples will be expanded to probe phonon-driven evolution of excited states.

Future Work Chemistry

We will generate final samples of the range of chiralities required for both Raman and pump-probe measurements. Raman work will also require final establishing of matrix materials for applying strain to aligned samples.

Raman

Our first priority will be obtaining REPs for C13-substituted versions of the (7,5) and (7,6) structures. Unsubstituted samples will also be studied as a baseline. (7,4) and (10,4) metallic will be studied to extend metallic behaviors to non-armchair species and to access how non-Condon couplings are impacted by cross-coupling to additional phonon modes.

In studies of active modulation of non-Condon and interference behaviors by applying strain, we will target again the (7,5) and (7,6) structures. Interference behaviors will be studied in modulated (10,5) and in newly obtained (12,4) structures.

Excited-State Dynamics

Studies on cycloparaphenylenes will be completed and nanotube measurements will commence, starting with the (10,5). We anticipate unique quantum interference behaviors in its relaxation dynamics due to the proximity of its E33 and E44 transitions to each other. The (10,2) structure will serve as a useful reference material since it may be optically excited in the same energy regime, but will have no overlapping transitions.

Theory

We will refine our condensed matter models to resolve inconsistencies between metallic and semiconducting descriptions. LANL quantum chemical approaches will be used as a route to incorporate exact descriptions of phonon coordinates in state-mixing formalisms. We will also resolve differences observed in non-Condon behaviors of RBM vs. G-modes. To advance our ability to model nanotube excited state dynamics, we will continue modeling of cycloparaphenylenes focusing on the non-adiabatic excited state dynamics and non-radiative relaxation processes using our unique-to-LANL codes. The results will be directly compared to the pump-probe spectroscopic measurements delivering a complete picture of photophysical processes in these fascinating materials with unique optical properties.

Conclusion

Our effort will lead to an understanding of how interactions between electronic and vibrational structure in carbon nanotubes (CNTs) leads to quantum interference behaviors and gives rise to breakdown in fundamental descriptions of quantum interactions. These will be pioneering studies in an emerging area of CNT photophysics. The result will allow us to determine what consequences these behaviors have for nanotube optical responses that underlie photonics, optoelectronics, and energy harvesting applications. Ultimately, by revealing the origins and consequences of these new CNT quantum phenomena we will also generate the principles for how we may control them for enabling applications.

Publications

Berciaud, S., X. Li, H. Htoon, L. E. Brus, S. K. Doorn, and T. F. Heinz. Intrinsic line shape of the Raman 2D mode in freestanding graphene monolayers. 2013. *Nano Letters*. 13: 3517.

Chen, H., M. R. Golder, F. Wang, S. K. Doorn, R. Jasti, S. Tretiak, and A. K. Swan. Raman-active modes of even-numbered cycloparaphenylenes: comparisons between experiment and DFT calculations with group theory arguments. *Physical Review X*.

Duque, J. G., E. H. Haroz, J. Simpson, H. Telg, A. Height-Walker, X. Tu, M. Zheng, J. Kono, and S. K. Doorn. Asymmetric Raman excitaiton profiles and non-Condon effects in the resonance Raman response of armchair carbon nanotubes. To appear in *Physical Review B*.

Fagan, J. A., C. Y. Khripin, C. A. S. Batista, J. R. Simpson, E. H. Haroz, A. R. H. Walker, and Zheng. Isolation of Specific Small-Diameter Single-Wall Carbon Nanotube Species via Aqueous Two-Phase Extraction. 2014. *ADVANCED MATERIALS*. 26 (18): 2800.

Haroz, E. H., J. G. Duque, X. Tu, M. Zheng, A. R. Hight Walker, R. H. Hauge, S. K. Doorn, and J. Kono. Fundamental optical processes in armchair carbon nanotubes. 2013. *Nanoscale*. 5: 1411.

Lim, , A. R. T. Nugraha, Cho, Noh, Yoon, Liu, Kim, Telg, E. H. Haroz, G. D. Sanders, Baik, Kataura, S. K. Doorn, C. J. Stanton, Saito, Kono, and Joo. Ultrafast Generation of Fundamental and Multiple-Order Phonon Excitations in Highly Enriched (6,5) Single-Wall Carbon Nanotubes. 2014. *NANO LETTERS*. 14 (3): 1426.

Telg, H., E. H. Haroz, J. G. Duque, C. Khripin, J. Fagan, X. Tu, M. Zheng, J. Kono, and S. K. Doorn. Diameter dependence of TO phonon frequencies and the Kohn anomaly in armchair single-wall carbon nanotubes. *Physical Review B*.

Enhancing Thermoelectric Properties of Topological Insulators through Nanostructuring

Nikolai Sinitsyn
20130348ER

Introduction

This project is motivated by the recent discovery of new materials, called Topological Insulators (TI) which demonstrate a new state of electrons that is topologically distinct from the conventional band insulators or metals. One of the manifestations of the topological properties is appearance of conducting electron states, on the surface of material, which propagate throughout the sample without elastic scatterings. Our idea is that nanostructuring of TIs can substantially increase the role of these states in charge and thermal transport to the level of obtaining a device structure with record high thermoelectric characteristics.

Benefit to National Security Missions

The major applications of thermoelectrics are to create (i) efficient silent and compact solid state refrigerators and (ii) various technologies to recover heat energy, e.g. from car engines and microprocessors and convert it back to useful electricity. These applications address DOE goals in energy efficiency. Further, the climate impact is positive because substances used in modern refrigerators are harmful for atmosphere, e.g. they destroy the ozone layer. Replacing them by thermoelectric cooling will solve the problem. In addition, new energy sources for satellites can be built from thermoelectrics, in support of NNSA missions.

Progress

We have successfully synthesized a number of Te-based nanostructured topological materials, including Bi₂Te₃ and SnTe nanowires, via vapor-liquid-solid mechanism using a vapor deposition system in Zhang's lab at IUB. We developed a unique approach to fabricate thermoelectric devices of these nanowires through multiple-lithography and deposition process in CINT integration lab. We have performed a series measurements of electrical conductivity, Seebeck coefficient and thermoelectricity on these devices as functions of tempera-

ture and nanowire size. The figure of merit ZT of these devices are calculated and are compared with bulk materials. We are in preparation of a manuscript based on these results.

CI, Dr. Han Htoon and a visiting graduate student (funded as a subcontractor), Mr. Enzi Xi, have performed first measurements of intermediate size nano wires of SnTe - material that has a similar composition to basic topological insulators. Our goal was to explore effects of strong spin orbit coupling on figure of merit, ZT, of this thermoelectric.

We found that as the diameter of the SnTe nanowire decreases, the electrical and thermal conductivities do not change much but, surprisingly, the Seebeck coefficient increases, so ZT increases. This finding is surprising and brings good news for our project. In fact, our original idea of the project assumed that Seebeck coefficient is the least controlled and can be the major problem. Moreover, changes were observed at relatively thick nanowire diameter ~700nm. This rules out possible quantum effects of confinement. Our current theory is that nanowire geometry either removes or introduces additional strains in the atomic lattice that, via spin orbit coupling, substantially change the band structure and thus incidentally increases the Seebeck coefficient.

On the theoretical side, PI, Dr. Nikolai Sinitsyn, and collaborators have performed theoretical studies of properties of generic Dirac electron systems, including spin orbit coupling effects on electronic characteristics. The possibility to determine parameters of Dirac electrons by optical means were predicted. The article with results is currently submitted to Phys. Rev. Lett. journal. Results indicate that important parameters such as the strength of spin orbit coupling can be measured purely optically by LANL capabilities in spin noise spectroscopy.

The major challenge for year 2015 is to continue reducing diameter of nanowire down to several nanometers in

order to observe predicted changes of thermal and electrical conductivities that should further improve ZT. To this end, after numerous attempts to synthesize Bi₂Te₃ nanocrystals of controlled and ultra-small size by way of high-temperature, surfactant-stabilized solution growth, rapid progress has recently been made. We have developed protocol for the synthesis of ultra-small Bi₂Te₃ nanoparticles in the 3-10 nm range that entails direct reaction of bismuth oleate and tellurium trioctylphosphine (in contrast with most literature approaches that have relied on fabricating either the Bi or Te nanoparticles/nanowires then chemically converting to the Bi-Te compound of interest). Our new method is compatible with ultra-thin nanowire synthesis by a catalyzed solution-phase growth process for which both bismuth and tin metal nanoparticle catalysts have been synthesized.

Future Work

We will develop a theory of thermoelectric effects in thin films and nanowires made of TIs. This goal will require an understanding the role of disorder and quantum confinement and electron/phonon interactions on the topologically protected surface states. Our preliminary studies showed complexity of the disorder effects on transport whose understanding promises to reveal unusual properties. Complimentary experimental efforts will be focused on measurements of thermal transport in topological insulator nanowires using state of the art CINT Discovery platform. This will provide a selective probe for conflicting processes determining the figure of merit. Theoretical results will be benchmarked against experimental data and used to provide a guideline for subsequent experimental studies.

Conclusion

We will develop a theory of thermoelectric effects in thin films and nanowires made of TIs. This goal will require an understanding the role of disorder and quantum confinement on the topologically protected surface states. Developing a theory of thermoelectric effects and its application for optimizing the sample parameters to increase the figure of merit is the main theoretical goals of this project. Complimentary experimental efforts will be focused on measurements of thermal transport in topological insulator nanowires using state of the art CINT Discovery platform.

Publications

Lin, J., and N. A. Sinitsyn. Three level Landau-Zener-Coulomb model: Exact transition probabilities in the three-state Landau-Zener-Coulomb model. 2014. *Journal of Physics A: Mathematical Theoretical*. 47: 015301.

Lin, J., and N. A. Sinitsyn. The model of a level crossing with a Coulomb band: exact probabilities of nonadiabatic transitions. 2014. *Journal of Physics A: Mathematical Theoretical*. 47: 175301.

Ren, J., and N. A. Sinitsyn. Braid Group and Topological Phase Transitions in Nonequilibrium Stochastic Dynamics. 2013. *Physical Review E*. 87: 050101(R).

Roslyak, O., and A. Piryatisni. Sonoluminescence of carbon nanotubes. 2013. Unpublished Document.

Sinitsyn, N. A.. Landau-Zener Transitions in Chains. 2013. *Physical Review A*. 87: 032701.

Sinitsyn, N. A.. Nonadiabatic transitions in exactly solvable quantum mechanical multi-channel model: role of level curvature and counterintuitive behavior. 2013. *Physical Review Letters*. 110: 150603.

Tse, W., A. Saxena, D. Smith, and N. A. Sinitsyn. Spin and Valley Noise in Two-Dimensional Dirac Materials. 2014. *Physical Review Letters*. 113: 046602.

Xu, E. Z., Z. Li, J. A. Martinez, N. A. Sinitsyn, N. Li, B. Swartzentruber, and J. A. Hollingsworth. Diameter dependent thermoelectric properties of individual SnTe nanowires. *Applied Physics Journal*.

“Upscaling” Nanoscale Thermoelectrics: The Meso-macroscale Design Challenge for Real-World Energy Needs

Jennifer A. Hollingsworth
20130350ER

Introduction

The overarching goal is to address the challenge of scale that is uniquely relevant to nano-enabled thermoelectrics (TEs). Nanoscale phenomena can dramatically alter and improve the fundamental properties of semiconductor materials for applications in TEs, such as the electronic density-of-states (DOS) and charge carrier or phonon mobilities and interactions. However, in contrast with other potential nano-based technologies (lighting, sensing, energy harvesting/storage), TEs requires bulk-scale assemblies to achieve high efficiencies at the device level (cm rather than nm- μ m scale). This requirement remains a key challenge to translating properties efficiencies at the nanoscale to practical efficiencies in applications. We aim to bridge this literal, physical gap in nanomaterials integration by developing new synthetic methodologies for interconnecting nanomaterial building blocks into functional networks and composite structures. We will also address an underpinning “knowledge gap” in terms of understanding how the key transport properties—electrical and thermal—change across the extremity of length scales from nano/meso- to macroscale. Though the problem of scale is distinctly paramount for TEs, the synthetic strategies and new principles of multi-scale transport will be applicable to a wide range of nano-enabled technologies. To these ends, we will pursue the following three objectives:

1. Assessing and optimizing nanoscale TE functionality by way of baseline studies in single-NW systems of controlled size and surface roughness.
2. Understanding and controlling meso-macroscale TE properties of novel branched/networked NW constructs.
3. Assessing the viability of aerogels as a NW TEs matrix.

Benefit to National Security Missions

Successful completion of the proposed objectives will provide advances in synthesis, characterization

and theory that will lay the foundation for successful, functional translation of nanoscale phenomena to the macroscale, as well as understanding how properties scale with changes in length scale and complexity. More specifically, we will also develop novel functional composites comprising NW networks in aerogels for applications in thermoelectrics. Further, we will establish new non-contact characterization and modeling tools for addressing transport processes from simple to branched NWs and their composites. This aspect of the work contributes directly to DOE Basic Science initiatives and is relevant to the Scientific Discovery and Innovation Mission in the Basic Understanding of Materials.

The work also fundamentally addresses challenges faced by the implementation of nano-enabled thermoelectrics in real-world device architectures, where success would have a clear impact on Mission Relevance in Energy Security (Renewable Energy) and the Environment (Climate and Energy Impact and even “waste” management), as thermoelectrics tackles both waste heat utilization and heat management issues.

Lastly, the new composite materials will be tested and operated at temperature extremes (cold and hot) and entail conversion of energy types (e.g., heat to electricity) and energy translation across interfaces, with direct relevance to complex materials design and characterization for MaRIE. In addition, the technology developed will support longer term development of small-size, rapid-response temperature probes for extreme environments, e.g., explosives.

Progress

Significant progress in both theory and experiment are described below for each Objective.

Objective 1: We completed a systematic study of PbS, PbSSe, and PbSe nanowire (NW) synthesis by catalyzed solution-liquid-solid (SLS) growth, investigating numer-

ous synthetic variables to obtain size, surface, and branching-controlled NW growth. The variables were: bismuth (Bi) nanoparticle catalyst size (5-38 nm diameters); temperature (175-320 oC); purity of coordinating-ligand (e.g., 90% trioctylphosphine versus 97%; 90% trioctylphosphine oxide versus 99%); and precursor (dual-source versus single-source). In support of these studies, single-source precursors for PbS and PbSe were synthesized and characterized by NMR (working with Ryszard Michalczyk, B-11, and Koushik Ghosh, MPA-CINT). Overall, we currently favor use of higher purity ligands and single-source precursors, and we discovered that temperature is the key variable for tuning surface morphology from rough to smooth and NW branching from straight to multiply branched, both trending with increasing temperature, where our temperature range spans below and above the melting point of bulk Bi (271 oC). In fact, we obtain uniquely high yields of branched NWs, e.g. 90% for PbSe. We are currently preparing a manuscript describing the synthesis of branched lead chalcogenide NWs. We have also established a collaboration with Andrew Sutton (C-IIAC), an expert in organometallic synthesis, who is preparing a PbTe single-source precursor, which we hypothesize will allow us to address the significant challenge in realizing stoichiometric control in the PbTe system. To the best of our knowledge, ours would be the first synthesis of SLS-grown PbTe NWs.

NW building blocks in hand, we have begun fabrication and testing of single-NW and thin-film devices, capitalizing on new collaborations within and outside LANL. With external collaborator, Enzhi Xu (Indiana Un.), we have fabricated single-NW devices from PbS NWs (dropcast NWs onto substrate with large electrodes; electron-beam lithography and metal deposition to link NWs to electrodes), for which microamp currents were occasionally obtained, confirming reasonable conductivity for these thin wires. Challenges: improving consistency of NW device performance and lifetime in air. We have also worked with Sandia's Brian Swartzentruber toward single-NW TE devices, but to date have been limited by the need to manipulate NWs into precise positions required by the device architecture ("suspended" NWs). We have further fabricated thin-film devices comprising NW mats, but these have not yielded desired electrical conductivity. To address this issue, we are working to remove native, non-conducting surface ligands toward enhanced electrical transport through the NW films. We have explored ligand replacement (with short-chain ligands) and hydrazine treatment, modifying methods to avoid crack formation and to enhance external ligand electronic doping. Importantly, we have established a further new collaboration with Marcelo Jaime (MPA-CMMS) with the intent to revitalize his capability for complete thermoelectric (TE) device characterization. Marcelo

has also provided key advice with respect to device fabrication, causing us to modify the "test-bed" device-design to be used for comparative NW-structure/function studies (Wang et al. Nano Lett. 8, 2008, 2283).

Objective 2: Manuscript submitted to Nano Letters: Enhanced Thermoelectric Properties of Semiconductor Nanowire Networks. The manuscript describes a novel theoretical approach to mapping TE "networks" on two-port networks. Here, Piryatinski argues that in contrast to a conventional single-port (i.e., resistor) network model, our model allows for large-scale calculations and also predicts convergent TE figure-of-merit, ZT, behavior with increasing number of junctions. Using this model, the numerical simulations of ZT are performed for branched and Cayley-tree NW networks. The simulations show that the phonon impedance of the network junctions plays the dominant role in the enhancement of the network performance. Importantly, depending on the phonon impedance mean value, the ZT enhancement of random networks can vary in the range of 20-150%. To provide connection with experiment, the manuscript further demonstrates how the model parameters can be related to the observables available in TE measurements.

Objective 3: (a) We have successfully incorporated PbSe NWs into a silica-aerogel monoliths. **(b)** We have determined optimal NW solution chemistry to realize placement of high quality NW films on top of silica-aerogel supports. In Future Work, these will be the foundation for a new device design that will permit complete TE parameter characterization. **(c)** Working with collaborator, Prof. Stephanie Brock, we have prepared pure NW-aerogels. Assessment of these novel porous, networked structures is ongoing.

Future Work

Nanoscale test systems

With NWs in hand, we will focus on device fabrication and characterization to determine nanoscale effects on key TE parameters: the electronic DOS – i.e., ultranarrow sub-10 nm NW diameter versus tens of nms, and carrier/phonon transport – i.e., smooth versus nanoroughened wire surfaces. Additional NW structural/compositional characteristics can be modified to achieve more complete optimization of TE properties, but our aim here is instead to investigate the translation of nanoscale effects across vast length scales. For this reason, we focus our studies on NW size (quantum confinement) and surface properties.

Meso-macroscale integration/exploration

Synthetic efforts shift to this Research Goal, as we focus on new methods for interconnecting NWs into branched/hyperbranched structures and/or simply linked as designed model systems for understanding scaling effects on

TE properties. By linking NWs together into progressively more complex assemblies, we will experimentally address how branch points affect carrier/phonon transport and whether these processes can be controlled by tuning the NW-NW interface and concentration of branch sites. Experimental and theoretical characterizations on individual or small collections of NW branch points will encompass mesoscale processes. We will further increase NW network complexity via extreme hyperbranching or gelation condensation chemistry, where latter effort was begun this year, to access transport processes in complex interconnected NW networks and to investigate non-equilibrium phonon dynamics that may result from bulk disorder & fractional dimensionality.

Aerogel utility

We will optimize NW-aerogel composite/interface chemistry to (a) maximize NW loading within AGs and (b) optimize NW films prepared on top of AG supports, respectively. We will incorporate dopants in AG as “temperature sensors.” We will assess TE performance of NW/AG monoliths.

Conclusion

The technical goals that will be pursued are:

1. Using solution-phase methods, we will synthesize NWs that allow us to test nanoscale effects on key TE parameters: the electronic DOS – i.e., ultranarrow sub-10 nm NW diameters, and carrier/phonon transport – i.e., smooth versus nanoroughened wire surfaces.
2. We will develop new synthetic methods for interconnecting NWs (from Obj 1.) into branched and hyperbranched structures as designed model systems for understanding/controlling scaling effects on TE properties.
3. We will develop methods for embedding NWs into aerogels and assess the utility of aerogels as scalable matrices to realize bulk-scale NW TEs.

Publications

Acharya, K. P., T. G. Holesinger, J. A. Crisp, S. A. Ivanov, D. J. Williams, J. L. Casson, M. Sykora, and J. A. Hollingsworth. Layer-by-layer fabrication of nanowire sensitized solar cells: geometry-independent integration. 2014. *Advanced Functional Materials*. : DOI: 10.1002/adfm.201401225.

Roslyak, O.. Enhanced thermoelectric effect of branched nano-wire trees. Invited presentation at Fordham University Seminar. (New York, 12 May 2013).

Roslyak, O., and A. Piryatinski. Thermoelectric effects in disordered branched nano-wires. 2013. In *American*

Physical Society Annual Meeting 2013. (Baltimore, MD, 18-22 March 2013). , p. BAPS.2013.MAR.W12.14. College Park, MD: Bulletin of the American Physical Society.

Roslyak, O., and A. Piryatinski. Enhanced thermoelectric properties of semiconductor nanowire networks. To appear in *Nano Letters*.

Xu, E. Z., Z. Li, J. A. Martinez, N. Sinitsyn, H. Htoon, N. Li, B. Swartzentruber, J. A. Hollingsworth, J. Wang, and S. X. Zhang. Diameter dependent thermoelectric properties of individual SnTe nanowires. *Nanoscale*.

Giving Cold Atoms Weight: Creating Heavy Fermions in Optical Lattices

Cristian D. Batista
20130385ER

Introduction

Lanthanide and actinide based compounds belong to the family of strongly correlated materials. The coexistence of localized f-electrons with itinerant s, p or d electrons that interact via the so-called Kondo exchange, leads to very unusual phenomena such as exotic magnetic orderings, unconventional superconductivity and heavy fermion behavior. One of the most intriguing phenomena is the non-Fermi liquid (“strange metal”) behavior that arises near the quantum phase transition or quantum critical point (QCP) that separates the magnetically ordered and the Heavy fermion states. This “strange metallic state” originated by the fluctuations of a QCP usually appears in the proximity of unconventional superconducting states. Unfortunately, the experimental characterization of this fascinating state of matter is limited by many factors that we discuss below. Consequently, there is a need for finding controllable realizations of this physics that can shed light on the basic properties of the strange metallic state that arises near the QCP. We will address this need by modeling a class of atomic gases known as Bose-Fermi resonant systems in an optical lattice, and identifying regimes of parameters for which the atomic system can be mapped into a lattice of local moments (localized f-electrons) that interact via exchange with itinerant electrons. Describing and testing this non-trivial mapping requires a description that bridges the Angstrom-sized atomic physics scale with the micron-sized optical lattice physics.

Benefit to National Security Missions

The possibility of trapping cold atoms in periodic potentials opens new horizons for the experimental and theoretical study of correlated matter. We are slowly discovering that the physical laws that govern the interactions between these atoms are very similar to the ones that describe the interaction between electrons in actinide based inter-metallic compounds. Besides being the basic materials for nuclear applications, these compounds are among the most complex correlated materials in nature.

For this reason, it is very challenging to understand and predict its electronic and structural properties. Cold atoms offer a unique opportunity of isolating the essential ingredients that control the properties of these materials and tuning the most relevant parameters in a way that would not be possible by directly studying these compounds.

We argue that the closed channel amplitude physics of the Feshbach resonance gives access to the “Kondo physics” responsible for heavy fermion behavior in inter-metallic compounds. The first goal of this project is to describe the narrow resonance properties and derive a model for the effective atom-atom interactions from first principles. The second goal is to connect this model with the one that is traditionally used to describe the electronic properties of inter-metallic compounds. By guiding cold atoms towards a first realization of heavy fermion physics, this project will establish the first one-to-one connection between cold atoms and inter-metallic compounds. This research is relevant for understanding the origin of the complex electronic properties of actinide based materials, which are relevant for the nuclear energy security mission.

Progress

The scattering properties of narrow Feshbach resonances exhibit the fast energy dependence that has traditionally been associated with finite range interactions. However, rather than interactions-at-a-distance, the narrow resonance interactions are better described as interactions-over-a-long-time.

We found that the interaction time spent in addition to the time necessary for bridging the effective scattering length distance is spent in the spin channel with the quasi-bound state that causes the Feshbach resonance by coupling to the incident channel. This binary atom channel is called the ‘closed channel’. The amplitude of the system in this channel can play the role of

an effective spin in binary-atom on-site interactions in an optical lattice.

In describing a narrow Feshbach resonance of atoms in an optical lattice, we have shown that the effective boson model Hamiltonian can describe the exact harmonically confined binary atom system near resonance if the width of the resonance is smaller than the zero-point energy of the harmonic trap. In this calculation, the optical lattice lasers are assumed to be tuned to the magic frequency for which the molecular bound state experiences the same force as the individual atoms.

In describing narrow Feshbach resonances of free atoms, we have shown that the effective scattering length is the scaling quantity with a magnetic field dependence that can be ‘collapsed’ (different atoms and hyperfine states give the same scaled effective length dependence if the resonance is sufficiently narrow). We have tested the scaling behavior for two narrow and one broad resonance in Lithium Potassium interactions. We have shown how physical similarity applied to the narrow resonance scaling allows the mapping of fermion many-body experiments conducted at different resonances.

In a parallel effort, we derived a Kondo Lattice model using the first principle parameters that were obtained from the above-described calculation. Having the parameters t , ϵ , and g as a function of more fundamental parameters of the atomic gas. Based on this mapping, we were able to connect the phases of the atomic gas system with the ones that are obtained by solving the equivalent Kondo Lattice system. By performing Density Matrix Renormalization Group (DMRG) calculations for a one-dimensional version of the Kondo Lattice model, we obtained the expected quantum critical point (QCP) separating the magnetically ordered state from the paramagnetic phase. In higher dimensions, this QCP signals the onset of the heavy fermion phase that is characteristic of f-electron systems, such as lanthanide and actinide based inter-metallic compounds. We demonstrated that the atomic gas counterpart of this phase diagram corresponds to a transition between a Bose-Einstein condensate and a heavy fermion phase for atoms.

We are currently searching for ways to tune different parameters of the atomic gas system and make them independent of each other. This step is important to determine what are the regimes of the Kondo Lattice system that can be accessed with the atomic gases.

We are also writing a manuscript entitled “Giving Weight to Atomic Gases”, which includes most of the results that are reported in the previous paragraphs.

Future Work

- complete our derivation of the Kondo Lattice Hamiltonian from first principles
- Complete the two manuscripts that we started during this fiscal year
- Extend our DMRG calculations to compute dynamical correlation functions
- Explore ways of producing reliable results in dimension higher than one.

Conclusion

The successful accomplishment of this project will guide the realization of heavy fermion phases with atomic gases near Feshbach resonances. This extraordinary achievement will open an intriguing new avenue: controlled experimental explorations of the critical regime near the fermionic quantum critical point that separates the magnetically ordered state from the heavy fermion phase. This breakthrough would have a profound impact on our understanding of actinide and lanthanide based compounds that are of strategic relevance to LANL’s mission.

Publications

- Rahmani, . QUANTUM DYNAMICS WITH AN ENSEMBLE OF HAMILTONIANS. 2013. MODERN PHYSICS LETTERS B. 27 (26).
- Rahmani, A., T. Kitagawa, E. Demler, and C. Chamon. Cooling through optimal control of quantum evolution. 2013. PHYSICAL REVIEW A. 87 (4): -.
- Rahmani, A., and C. D. Batista. Anyonic liquids in nearly saturated spin chains.

Topology in Superposition: Quantum Decoherence in Many-body Systems

Wojciech H. Zurek
20130409ER

Introduction

We will investigate decoherence of quantum systems in realistic models, where the environment causing decoherence is a many-body system (i.e., a system composed of interacting subsystems). In particular, we shall study decoherence caused by environments driven through a critical point of a quantum phase transition. Of special interest is the quantum information-theoretic analysis of the process of amplification of selected observables and its relation to the quantum-classical transition.

We will also study superpositions of collective states of many-body systems. Both spin and field theoretic models of phase transitions exhibit stable topological defects (monopoles, vortex lines, domain walls, etc.) as well as non-topological but relatively stable configurations such as solitons. These objects are the epitome of locality. Yet, the underlying many-body system is quantum and, thus, abides by the quantum principle of superposition. Therefore, it should be possible to construct superpositions where a topological defect is in a non-local “Schrödinger cat” state, with a vortex or soliton simultaneously in two places. Such situations are difficult to even imagine or represent in terms of effective, mean-field “order parameter” theories. However, there are solvable models that should allow us to study how manifestations of non-locality and other explicitly quantum behaviors (present at the microscopic level) get eliminated from collective many-body states on the macroscopic level.

All along we will explore possibilities of experimental testing of our predictions in cold atom and condensed matter systems with an eye towards applications in materials science and metrology.

Benefit to National Security Missions

This research will contribute to condensed matter science at Los Alamos, providing critical insights into quantum technological applications. These are diverse, including superconductors, metrology, etc. Computing

may be most significant and urgent. There is the dream of quantum information processing, but even if it turns out to be more distant than some hope, the fundamental elements of computers will reach single atom size this decade (“Moore’s law”). Understanding what happens to superpositions of collective degrees of freedom and of relevant sources of decoherence is indispensable in these (and similar) applications of interest to LANL, the NNSA and DOE. Moreover, quantum superpositions in cold atom systems that we plan to study can be used to enhance sensitivity of measuring devices. Capabilities foreseen for MaRIE seem well suited for condensed matter studies related to this project (dynamics of phase transitions).

Progress

The study of quantum coherence and decoherence in many body systems has progressed along several parallel lines, some of them stimulated by recent experimental developments.

Our paper connecting decoherence with amplification (Zwolak, Riedel and Zurek, Amplification, Redundancy, and the Quantum Chernoff Information, *Phys. Rev. Lett.* 112, 140406 (2014)) has been just published. It provides modern, quantum information – based understanding of the nature and of the role of amplification in the transition from quantum to classical. This is an important step in the development of the “quantum Darwinism” program Zurek has championed.

With Dziarmaga, Zurek has investigated dynamics of phase transitions in the Kosterlitz-Thouless universality class. This is important as there are several interesting systems that fall into this category, and as the near-critical behavior of quantities such as the relaxation time is not polynomial (as is the norm for other second order phase transitions) but, rather, exponential. The question is then how to adapt the Kibble-Zurek mechanism (KZM) to this non-polynomial setting. The added urgency has

to do with the ongoing experiments on one – dimensional Bose –Hubbard model (that belongs to the Kosterlitz-Thouless universality class). The unexpected answer is that KZM predictions apply, but not in the naïve form (that depends only on the asymptotic values of critical exponents). These advances have been reported in a preprint (Quench in 1D Bose-Hubbard Model: Topological Defects and Excitations from Kosterlitz-Thouless Phase Transition Dynamics).

With Julian Sonner of MIT and del Campo of Los Alamos Zurek has initiated investigation of KZM in the context of holographic duality. Holographic duality is a powerful approach that allows one to treat strongly coupled (i.e., intractable) field theoretic and many – body models using a “dual” system – anti de Sitter Universe – that is weakly coupled, and, therefore, more tractable. A preprint with the results has just appeared (Universal far-from-equilibrium Dynamics of a Holographic Superconductor). It confirms the KZM predictions for the winding numbers, but it also opens several interesting questions about KZM and holographic duality we intend to pursue in the future.

Zurek has continued his work on quantum foundations, including a recent update prepared for the Solvay conference “The Theory of the Quantum World.”

Future Work

In the third year of the project we expect to continue work on Chernoff information as a way to characterize information amplification in the process of decoherence. This time the focus is likely to be on spin environments. This will involve both analytic and computer studies of decoherence in the relevant many-body systems.

We are also studying the phase transition in the quantum one dimensional Bose-Hubbard model. This is important, as there is an experiment ongoing on this subject in relatively small systems in which the transition is emulated in optical lattices of modest size (chains of ~ 100 atoms). As the 1D quantum Bose-Hubbard model belongs to the Kosterlitz-Thouless universality class, where the scalings near the critical point are not polynomial, creation of topological defects may exhibit peculiarities that would not be expected in the more usual phase transitions.

Last but not least, we are attempting to extend the treatment of defect formation in ion Coulomb crystals to the quantum regime. We have some preliminary results that are quite encouraging, but more is needed for a self-contained paper.

Both the quantum one-dimensional Bose-Hubbard model and quantum Coulomb crystals require use of advanced quantum algorithms that use entanglement to handle suit-

ably large quantum systems. We expect to take advantage of computer facilities at Los Alamos and elsewhere for this purpose.

Conclusion

We will characterize decoherence of topological defects in different theoretical models describing both magnetic and cold atom systems. In both cases, we will quantify how a many-body quantum environment interacting with a topological defect leads to the destruction of a coherent quantum superposition state in which a topological defect was initially prepared. This work will significantly advance fundamental understanding of the role of many-body effects in the ubiquitous decoherence process responsible for the emergence of the classical “everyday” world out of the quantum substrate.

Publications

- Campo, del, and W. H. Zurek. Universality of phase transition dynamics: Topological defects from symmetry breaking. 2014. INTERNATIONAL JOURNAL OF MODERN PHYSICS A. 29 (8).
- Dziarmaga, J., and W. H. Zurek. Quench in 1D Bose-Hubbard model: topological defects and excitations from Kosterlitz-Thouless phase transition dynamics. 2014. Scientific Reports. 4: 5950.
- Pyka, K., J. Keller, H. L. Partner, R. Nigmatullin, et.al. Topological defect formation and spontaneous symmetry breaking in ion Coulomb crystals. 2013. NATURE COMMUNICATIONS. 4: -.
- Riedel, C. J., W. H. Zurek, and M. Zwolak. The rise and fall of redundancy in decoherence and quantum Darwinism (vol 14, 083010, 2012). 2013. NEW JOURNAL OF PHYSICS. 15: -.
- Streltsov, A., and W. H. Zurek. Quantum Discord Cannot Be Shared. 2013. PHYSICAL REVIEW LETTERS. 111 (4): -.
- Tylutki, M., J. Dziarmaga, and W. H. Zurek. Dynamics of the Mott Insulator to Superfluid quantum phase transition in the truncated Wigner approximation. 2013. 21ST INTERNATIONAL LASER PHYSICS WORKSHOP. 414: -.
- Zurek, W. H.. Wave-packet collapse and the core quantum postulates: Discreteness of quantum jumps from unitarity, repeatability, and actionable information. 2013. PHYSICAL REVIEW A. 87 (5): -.
- Zwolak, , C. J. Riedel, and W. H. Zurek. Amplification, Redundancy, and Quantum Chernoff Information. 2014. PHYSICAL REVIEW LETTERS. 112 (14).
- Zwolak, M., and W. H. Zurek. Complementarity of quantum discord and classically accessible information. 2013. SCIENTIFIC REPORTS. 3: -.

Accurate Interfacial Structures for Atomistic Simulations: Minimizing the Grand-Canonical Free Energy

Danny Perez
20130517ER

Introduction

To carry out effective simulations at the atomic scale, it is crucial to know the details of the atomistic structures of materials. Often, obtaining that information experimentally is impractical so simple rules of thumb or geometric constructions are used to fill in the missing details. Sometimes, searches in limited spaces are used to explore the neighborhood of these guesses to assess their thermodynamic stability, which is often a good metric of their practical relevance. However, due to the astronomical size of the accessible configuration space, unconstrained searches are scarcely attempted. This problem is even more severe when the number of atoms in the structures of interest is unknown. This inability to thoroughly search the space of possible configurations severely limits the accuracy of atomistic simulations. In this project, we propose to develop efficient sampling algorithms that would allow to systematically and autonomously search for the most relevant structures. Our work will be based on a grand-canonical approach where the number of atoms in the simulation cell is not fixed, but can freely evolve according to its own dynamics, i.e., atoms will be able to dynamically come in and out of the simulation as time passes. This framework will be coupled to state-of-the-art sampling algorithms that will allow an efficient search of this huge grand-canonical space. Our method will first be demonstrated on problems related to grain boundary and interfaces in materials, a very important class of two-dimensional defects that often significantly affect mechanical properties. Our approach could have a profound impact in the field by leveraging modern simulation techniques to turn the “art” of predicting the atomic structure of materials into a systematic search process. This could dramatically improve the accuracy and predictive power of atomistic simulations.

Benefit to National Security Missions

Atomistic computer simulations play an increasingly important role in the prediction of properties of mate-

rials, or in the interpretation of experimental results. However, to be effective, these simulations need adequate starting points that properly represent the most probable atomic-scale structure of the material. This is crucial for a number of the lab’s missions, specially those dealing with materials in extreme conditions. For example, we recently found that adding a small proportion of interstitials to a grain boundary in tungsten (a leading candidate for the first wall of fusion reactors) can dramatically lower the stress at which the boundaries slide, which could lead to creep, but also enhance the ability of the materials to heal radiation-induced defects. To quantify these effects, it is paramount to first identify the structures that are thermodynamically relevant. These same challenges exist everywhere atomistic simulations of materials are used. Our proposed methodology will assist in the sampling of the possible structures and greatly help in the identification of the relevant ones. This has the potentials to significantly increase the power of atomistic simulations across a very wide range of problems of direct relevance to the lab’s missions, for example to investigate the properties of cladding materials in nuclear reactors, or to be able to predict the response of polycrystalline materials to shock, to name only a few examples. This capability directly supports mission needs for DOE Office of Science, Nuclear Energy, and MaRIE while enhancing our basic understanding of materials mission.

Progress

The last year has been dedicated to the development, implementation, and comparison of different sampling approaches to the problem of so-called grand-canonical thermodynamics in materials. These methods allow one to simulate systems where the number of atoms is not constant because of a coupling with a reservoir of atoms (usually the extended environment in which a particular configuration is embedded). Upon testing many different approaches, we settle on a combination of “adaptive force biasing” multicanonical sampling combined

with a parallel tempering approach and a thermodynamic integration at different particle number. In simple terms, we first run different simulations with varying number of atoms. In these simulations, which each run on multiple processors, we characterize the thermodynamics on a wide range of temperature. A second set of simulations is then carried out at high temperature to “stitch” the different simulations together. This enables us to then predict the probability that the system would contain a given number of particle at a given temperature and to compute any thermodynamic quantity of interest at any temperature. Our approach combines several state-of-the-art approaches into a unique new capability that has not been applied to materials before. It should provide unique insights and significantly impact the way these systems are considered in the future.

We have implemented our approach into our in-house simulations codes and demonstrated its efficiency. We thoroughly validated the codes by comparing the results of different sampling techniques. As a first application, we investigated, in collaboration with an ongoing SciDAC project, the behavior of small helium clusters in bulk tungsten, a system of relevance to fusion energy production. We predicted the binding free energies of these clusters over a large range of temperature, a result that nicely complemented the other techniques used in that project. An article describing our results is submitted for publication in *Physical Review B* while the details of the method are discussed in another paper submitted for publication in *Physics Procedia*. Recently, we have begun exploring the behavior of realistic grain boundaries in copper, and already we are observing exciting new phenomena that could not have been investigated without our approach.

While we were investigating the formal underpinnings of the simulation methodologies we base our work on, we uncovered an unexpected equivalence between three simulations methods that are widely used in the field, namely Wang-Landau sampling, Statistical temperature molecular dynamics, and Metadynamics. The first and last methods are workhorses of computational thermodynamics. While they superficially share some resemblance, their formal relationships were never investigated. We demonstrated that the three methods can be made absolutely identical through a consistent choice of initial conditions and update rules. This unexpected equivalence opens the door to technology transfer between different communities that were previously working mostly independently. We published our findings in the *Journal of Chemical Theory and Computation*.

We presented the results of our work at conferences and workshops, including the congress of the American Physi-

cal Society, and received very positive comments.

This last year marked the end of our main method and code development activities. We are now starting to explore the behavior of real and technologically relevant systems, leading the way into an exciting and very productive final year of the project.

Future Work

During the third fiscal year, we will apply our novel methodology to the study of the thermodynamic properties of different grain boundaries in interfaces in metals. We will explore two different aspects of the problem: first addressing the behavior of grain boundaries in pure materials and then generalizing to the study of the segregation of impurities at grain boundaries in interfaces. We will first consider different families of boundaries in copper: stacking faults, pure tilt, pure twist, and twist tilt, in increasing order of complexity. These different boundaries will allow us to compare and contrast low-energy, very stable, grain boundaries, with complex, high-energy ones. We will investigate their propensity to exchange atoms with their environment. We will be especially interested in “phase transitions” whereby the structure of the boundaries could change with temperature. We expect this study to clearly demonstrate to the community the unique contributions obtained from our approach and to form the baseline upon which other systems will be compared. With this baseline established, we will move on to more complex systems with multiple chemical components. In collaboration with an ongoing SciDAC project on plasma/material interactions, we will explore the segregation of helium at boundaries in tungsten. This system is directly relevant to the understanding of the reaction of the material in conditions typical of future fusion energy reactors. We will generalize our approach to multi-component systems and investigate the efficiency with which He, formed during nuclear fusion reactions, can segregate and form bubbles at boundaries in W. This information is crucial to optimize the performance of the material in extreme conditions.

We will also write and submit manuscripts that discuss the details of our simulation approach, as well as the applications to Cu grain boundaries and He in W boundaries.

Conclusion

We will develop sampling algorithms based on an innovative grand-canonical approach. These methods will be used to explore the landscape of possible atomic-scale structures of materials. These techniques will allow researchers to systematically, simply, and efficiently search for the most relevant structures, instead on relying to informed guesses or searches in narrow parameter spaces. These

can then be used as the starting points of very high quality atomistic simulations that aim at predicting the behavior of materials. This new capability will first be applied to the exploration of the structure of boundaries and interfaces in materials.

Publications

Junghans, , Perez, and Vogel. Molecular Dynamics in the Multicanonical Ensemble: Equivalence of Wang-Landau Sampling, Statistical Temperature Molecular Dynamics, and Metadynamics. 2014. JOURNAL OF CHEMICAL THEORY AND COMPUTATION. 10 (5): 1843.

Perez, , Vogel, and B. P. Uberuaga. Diffusion and transformation kinetics of small helium clusters in bulk tungsten. 2014. PHYSICAL REVIEW B. 90 (1).

Vogel, T., and D. Perez. Sampling in the multicanonical ensemble: small He clusters in W. Physics Procedia.

Understanding and Controlling Magneto-Electric Coupling in Multiferroic Materials

Dmitry A. Yarotski
20130525ER

Introduction

The last few decades have seen the discovery of novel classes of correlated electron materials with exotic properties that few would have imagined. Multiferroic materials stand out among them, due to the ability to change their magnetization and/or polarization state with either electric or magnetic fields. This has the potential to revolutionize future energy, sensing and information technologies, as multiferroic circuits will combine the low power consumption and speed of field-effect devices with the permanence of magnetic elements. The remarkable properties of multiferroics emerge from strong coupling between coexisting electric and magnetic orders. Despite recent progress in the synthesis and characterization of single-phase and heterostructured multiferroic materials, the existing understanding of magnetoelectric (ME) coupling mechanisms is still controversial, and the dynamical properties of multiferroics remain practically unexplored. In particular, the role of low-energy excitations (phonons, magnons, etc.) in the emergence of multiferroic functionality has not been clarified.

Our ultimate goal is to leverage the unmatched LANL integration of material synthesis, advanced ultrafast optical techniques and forefront solid-state theory to test the dynamic limits of ME phenomena and reveal the mechanisms governing ME coupling in representative multiferroic materials. In pursuit of this goal, we will use intense THz pulses to directly excite low-energy modes and investigate their effect on magnetic and electric orders in each material. A unique set of time-resolved optical and soft X-Ray probes will allow unambiguous separation of spin, charge and lattice dynamics, and in conjunction with theoretical modeling will unveil the microscopic origin of ME coupling in multiferroics.

This integration of “passive” and “active” broadband ultrafast optical methods with forefront modeling expertise is a unique capability at LANL. The application of this capability to multiferroic materials is poised to make

a broad impact on condensed matter physics and will open new directions in complex materials research.

Benefit to National Security Missions

Our work directly addresses the Grand Scientific Challenges identified in the Basic Energy Sciences Advisory Committee (BESAC) report, which are central to DOE’s missions in energy, science, and security in general, and to the LANL Materials Grand Challenge in particular. The proposed integration of material synthesis, ultrafast optical techniques and forefront condensed matter theory represents the LANL Materials Strategy and should provide LANL, as well as CINT, with the capability to investigate emergent properties of complex materials through observation of the dynamical behavior of relevant order parameters and through selective excitation of the low-energy modes responsible for material functionality. Our thrust to interface materials science with ultrafast THz, optical and X-Ray coherent photon probes represents an essential element in the MaRIE strategy that connects the M4 facility to the Multi-Probe Diagnostic Hall. Proposed experiments will provide critical understanding of the mechanisms of magnetoelectric coupling and thus enable the design and synthesis of new multiferroic materials with controlled functionalities. Materials with tunable and novel functionality are an enabling component in the development of next-generation devices for sensing, information storage, and spintronics applications. We believe that our integrated capabilities in complex material design, synthesis and characterization will be of great interest to multiple sponsors, including DOE-BES, DOD, IC, and industry.

Progress

Our existing theoretical and experimental expertise in the physics of complex materials has ensured continuous progress towards the goals of this project. As in the previous year, our experimental efforts encompassed application of various ultrafast optical spectroscopies to unveil the dynamic coupling between magnetic and elec-

tric orders in a number of multiferroic materials. In particular, we completed the analysis and theoretical description of the optical pump-terahertz (THz) probe measurements of magneto-electric response of $\text{Eu}_{0.75}\text{Y}_{0.25}\text{MnO}_3$ multiferroic compound as a function of temperature. This material demonstrates extreme slow-down of relaxation of the photo-excited carriers above the antiferromagnetic phase transition near Neel temperature of 45K. In paramagnetic phase, the photo-induced metallic behavior is characterized by a narrow Drude peak (scattering rate 1 THz) indicative of relatively mobile carriers that relax back to equilibrium semiconducting state on the nanosecond timescales. However, below the magnetic transition temperature the relaxation becomes significantly (at least twofold) faster, indicating opening of the new relaxation channel – magnon scattering – enabled by the strong electron-magnon coupling in this material. These results demonstrate importance of spin-charge coupling in dynamic response of multiferroic materials and might have implications for their future application in optoelectronic devices.

We have also applied optical pump-optical probe spectroscopy to the same material to extract more details about electron-magnon coupling. While aTHz probe is more sensitive to the collective motion of delocalized photo-excited carriers, optical probes are nearly resonant with d-d transitions of the magnetic ions and provide indirect information about magnetic re-ordering that follows photon absorption. As expected, our results demonstrated that the optical response of $\text{Eu}_{0.75}\text{Y}_{0.25}\text{MnO}_3$ to pump photon energies of 1.55 and 3.1 eV is dominated by the d-d and p-d transitions on magnetic Mn ions. The photo-induced charges increase the occupancy of higher d-orbitals and create a localized spin excitation that results in ultrafast switching of super-exchange interactions. The decay of this localized spin state appears as the tremendous increase in the amplitude of photoinduced reflectance due to the strong coupling of optical transitions to the spin-spin correlations. The decay involves emission of spin waves (magnons) and occurs within hundreds of picoseconds of the pump pulse, in agreement with our optical pump-THz probe results. In addition, the relaxation of photoexcited electrons to equilibrium included the formation and trapping of the Jahn-Teller polarons on the Mn sites. We are currently developing theoretical model to describe this dynamics of co-existing lattice and spin excitations and determine its relation to magneto-electric coupling strength in this material.

In order to selectively pump the low-energy modes (phonons, magnons and electromagnons) and probe their effect on the magnetic and electric dipole ordering in multiferroics, we have developed a on-site high-intensity

ultrafast THz source. This new capability provides access to sub-picosecond THz pulses spanning 0.5-2.5 THz with electric fields up to 150 kV/cm. This system is coupled to broadband optical and second harmonic probes that are currently used for independent monitoring of the ultrafast dynamics of electric and magnetic orders in a range of multiferroic crystals and heterostructures.

Theory provided first-principles description of our $\text{Eu}_{0.75}\text{Y}_{0.25}\text{MnO}_3$ studies while simultaneously focusing on modeling more prominent multiferroic materials to guide further experimental efforts. For example, the double perovskite $\text{Bi}_2\text{FeMnO}_6$ system promises strong magnetoelectric coupling even at room-temperature. Using first-principles density-functional theory (DFT) calculations we investigated the magnetism in this material and its signatures at L2/L3 X-Ray absorption edges that can be measured in subsequent time-resolved X-ray magnetic absorption dichroism (XMCD) spectroscopy. We determined the magnitude of the spin and orbital magnetic moments of the Fe and Mn ions and calculated the spin dependent band-structure, density of states, and optical conductivity near spin resolved valence to conduction band transitions. Furthermore, we varied the c/a ratio with fixed volume, in order to investigate the substrate-mediated strain effects and determined optimal $c/a = 1.30$ for maximum spin magnetic moment. These results will be verified in $\text{Bi}_2\text{FeMnO}_6$ films grown on substrates with variable lattice mismatch, i.e. strain, using experimental measurements of XMCD and optical-conductivity spectra.

Future Work

Basing on the previous results, we will apply high intensity mid-to-far-infrared pulses for photoexciting low energy modes in bulk and heterostructured multiferroics. We have shown that photoexcitation of $\text{Eu}_{0.75}\text{Y}_{0.25}\text{MnO}_3$ compound leads to emission of spin waves and formation of self-trapped polarons that strongly affect charge carrier relaxation and transport properties. We will apply our intense THz capability to selectively excite relevant magnon and lattice modes in the same material and determine their relation to ferroelectric order by probing second harmonic generation efficiency as a function of temperature. Similarly, we will use Kerr spectroscopy to monitor the evolution of magnetic order. This set of measurements is expected to reveal the connection between macroscopic magnetoelectric response to microscopic coupling between spin and lattice sub-systems. Same experiments will be performed on TbMnO_3 and BiFeO_3 crystals. Complimentary selective excitation of electromagnon modes in all three compounds will allow to elucidate the relative contribution of coupled (electromagnon) and uncoupled (phonon, magnon) lattice and spin excitations to the emer-

gence of magnetoelectric functionality in multiferroics. Simultaneously, we will complete our experiments on spin order switching in $\text{Eu}_0.75\text{Y}_0.25\text{MnO}_3$ and BiFeO_3 crystals using ultrashort optical pulses to drive the material out of equilibrium, and X-Ray probe pulses to determine the timescales of magnetization switching. Similarly, we will interrogate magnetic and electric order dynamics in multiferroic $\text{BiFeO}_3/\text{La}_0.7\text{Ca}_0.3\text{MnO}_3$ and $\text{BaTiO}_3/\text{CoFe}_2\text{O}_4$ heterostructures. In these experiments, optical pulse will disturb ferroelectric order in one component and X-Ray pulses will probe the ensuing disturbances in the spin ordering in ferromagnetic compound. Such experiments will allow optimization of the heterostructure geometry for enhanced magnetoelectric response. Theoretical effort will focus on the description of microscopic processes responsible for ultrafast dynamics observed in multiferroics, and development of first-principles simulations of their dynamic spectral (THz to X-Ray) signatures based on microscopic low-energy models for magnetism.

Conclusion

We expect to provide a better understanding of the dynamics and origins of magnetoelectric (ME) coupling in multiferroic materials. We will answer three longstanding questions in the basic and applied science of ME systems: 1) How fast can the magnetization/polarization be switched, and how can this be improved? 2) What low-energy excitations are responsible for the strong interactions between electric and magnetic orders? 3) How can we manipulate these excitations to enhance the ME coupling and design better multiferroics? This will enable development of the principles of ME material design, with a significant impact on energy and information technologies.

Publications

Aguilar, R. Valdes, J. Qi, M. Brahlek, N. Bansal, A. Azad, J. Bowlan, S. Oh, A. J. Taylor, R. P. Prasankumar, and D. A. Yarotski. Time-resolved terahertz dynamics in thin films of the topological insulator Bi_2Se_3 . *Applied Physics Letters*.

Aguilar, R. Valdes, Y. M. Sheu, A. J. Taylor, R. P. Prasankumar, and D. A. Yarotski. Time resolved terahertz and second harmonic investigations in multiferroic RMnO_3 and RMn_2O_5 . Presented at 2013 March Meeting of The American Physical Society. (Baltimore, MD, 18-22 March, 2013).

Chen, A. P., H. H. Zhou, Z. X. Bi, Y. Y. Zhu, Z. P. Luo, A. Bayraktaroglu, J. Phillips, E. M. Choi, J. L. MacManus-Driscoll, S. J. Pennycook, J. Narayan, Q. X. Jia, X. H. Zhang, and H. Y. Wang. A New Class of Room-Temperature Multiferroic Thin Films with Bismuth-Based Supercell Structure. 2013. *ADVANCED MATERIALS*. 25 (7): 1028.

Chen, A. P., W. R. Zhang, F. Khatkatay, Q. Su, C. F. Tsai, L. Chen, Q. X. Jia, J. L. MacManus-Driscoll, and H. Wang. Magnetotransport properties of quasi-one-dimensionally channeled vertically aligned heteroepitaxial nanomazes. 2013. *APPLIED PHYSICS LETTERS*. 102 (9): -.

Chen, A. P., Z. X. Bi, Q. X. Jia, J. L. MacManus-Driscoll, and H. Y. Wang. Microstructure, vertical strain control and tunable functionalities in self-assembled, vertically aligned nanocomposite thin films. 2013. *ACTA MATERIALIA*. 61 (8): 2783.

Lee, J., and R. P. Prasankumar. Correlation between quantum charge fluctuations and magnetic ordering in multiferroic LuFe_2O_4 . To appear in *European Physics Journal B*.

Talbayev, D., J. Lee, S. A. Trugman, C. Zhang, S. W. Cheong, R. D. Averitt, A. J. Taylor, and R. P. Prasankumar. Spin-dependent polaron formation dynamics in $\text{Eu}_0.75\text{Y}_0.25\text{MnO}_3$ probed by femtosecond pump-probe spectroscopy. *Physical Review B*.

Spin-state Transitions as a Route to Multifunctionality

Cristian D. Batista
20140177ER

Introduction

The ability to sense and manipulate magnetic spins with tuning parameters such as electrical current, light, or voltage, underlies a great number of technologies. Of the three, current and light are well-established or on their way to technological use. However, coupling magnetic spins to voltage, e.g. the ferroelectric or dielectric properties of a material, remains a fundamental scientific challenge. Yet, coupling between magnetic spins and voltage has significant potential to reduce energy consumption and dissipation in the process of sensing and manipulating spins, and the need for this is specified in a number of recent funding calls especially by military agencies and metrology researchers seeking room-temperature low-powered magnetic sensors, in addition to civilian applications in sensing, computation circuits and memory, liquid crystal displays, and electronics. We take a novel approach by investigating the coupling between spin-state transitions and ferroelectricity. Specifically, we focus on metal-organic materials where these spin-state transitions are common under ambient conditions.

When the spin-states in neighboring spins communicate via magnetic exchange or structural distortions, the resulting orderings and phase transitions can become complex and fascinating, and their understanding requires a careful collaboration between analytic, computational, and experimental understanding. Spin-state transitions in metal-organics have been found in the last decade to be sensitive to chemical absorption, light and small pressures, and to be inherently coupled to the lattice and in some cases drive structural phase transitions. We explore using spin-state transitions to drive structural changes in materials that modify their ferroelectricity and/or dielectric constant. We build on our recent and intriguing results in a metal-organic. The potential for multifunctional cross-coupling between the magnetic-electric properties as well as the incident light, pressure, and chemical sensitivity opens the door to other potent multifunctional devices.

Benefit to National Security Missions

Our work primarily seeks to understand the chemistry and physics of metal-organic materials where spin-state transitions couple to the electric properties. Secondary to that, the coupling to light, pressure, and chemical absorbents can be studied. The ultimate applications of these materials are new magnetic and electric sensors, tunable high-frequency devices, and computer memory have eventual applications to energy security and remote sensing. This work closely relates to the DOE/SC. If we demonstrate this new approach to magneto-electric coupling, follow-on funding for applications of this work can be envisioned. Applied work on the very similar topic of multiferroics, which targets the same applications, is currently funded by DARPA, the ORNL, the Army, the Navy, and by the electronics industry.

Progress

We have grown and investigated ten different metal-organic materials to explore the interaction of magnetism with ferroelectric properties. These materials contain organic ligands and transition-metal magnetic ions. The purpose is find magnetic spin-state transitions, orderings, or orbital magnetism that can couple to the dielectric and ferroelectric properties. As described previously, the soft lattice and the designability of these materials makes them attractive for exploring new magneto-electric coupling mechanism. We have explored the following materials: triethylmethylammonium tetrabromoferrate (III), Tris[2-(pyrrol-2-ylmethyleneamino)ethyl] amine-Manganese(II), perovskite-based metal-organic frameworks containing Mn, Fe, Co and Ni, with methylammonium and dimethylammonium guest molecules, and finally trimer compounds $\text{NaMn}(\text{HCOO})_3$ and TNNiCH_3CN . Our methods consist of growing single crystals, measuring the magnetic and electric properties, and performing analytical and computational modeling. For most materials, synthesis routes were explored locally to achieve mm-sized single crystals, and a few compounds were obtained from collaborators. For the mea-

surements, we perform basic X-ray characterization, and then proceed to mapping the magnetism and the electrical properties including capacitance, conductance and electric polarization as a function of temperature and magnetic field. We exploit the unique capabilities of the National High Magnetic Field Laboratory to perform extremely sensitive measurements of the magnetic field dependence of the electric polarization. We also extend the phase diagrams of these materials up to 65 Tesla in pulsed magnetic fields, and down to 500 mK. Our theoretical results were obtained by combining a spin-wave analysis with classical Monte Carlo simulations.

For triethylmethylammonium tetrabromoferrate (III) we synthesized mm-sized single crystals from solutions. We verified an above-room temperature magnetic transition involving a change in the orbital magnetism that is accompanied by ferroelectricity. This coupling above room temperature is rather important to progress in this field, and we will aim to explore its mechanism and to increase the size of the magnetic jump.

We have found a synthesis route for single crystals of Tris[2-(pyrrol-2-ylmethyleneamino)ethyl]amine-Manganese(II). This material is part of a family of compounds that exhibits spin-state transitions, and ferroelectricity at different parts of their phase diagram and so by exploring different variations of this family of materials we will seek to directly toggle ferroelectricity by a spin-state transitions. Magnetic and electric property measurements are in progress.

For the family of perovskite metal-organic frameworks, we obtained single crystals from our collaborators at the University of Coruña (Spain), that contain the magnetic elements Mn, Ni, Co, and Fe, as well as a methylammonium guest molecule that could create electrically polar properties. We have mapped their electric and magnetic properties in pulsed and DC magnetic fields between room temperature and cryogenic temperatures. We find antiferromagnetic and ferromagnetic orderings below room temperature for different family members that in some cases couples to subtle changes in the dielectric constant. We have also synthesized and explored a similar Mn-based metal-organic framework at LANL using dimethylammonium instead of methylammonium. For that material found significant ferroelectric polarization that can be tuned by antiferromagnetism. The magnetic and electric phase diagram was mapped out and publication is in progress.

On the theory front, we predicted a series of field-induced multiferroic phase for the organic trimer compound TNNYCH₃CN. This prediction was recently confirmed by measurements of the temperature dependence of the

dielectric constant in an applied magnetic field performed by our external collaborator Yasu Takano. During this fiscal year we computed the different magnetic orderings that should correspond to each of the observed phases. Motivated by these calculations, Yasu Takano will perform a new experiment in July 2014. He will measure the magnetic field dependence of the electric polarization. The outcome of these experiments can be directly compared against the phase diagram predicted by our spin-wave calculations and Monte Carlo simulations.

Finally we have synthesized the trimer compound NaMn(HCOO)₃, which shows a frustrated arrangement of Mn trimers. Significant slow dynamics were observed consistent with magnetic frustration, however ferroelectricity was not observed.

In summary, we have made significant progress in expanding the nascent field of magnetoelectric coupling in metal-organic materials. Ten different materials were studied and magnetoelectric coupling was observed in several of them, including one material about room temperature. New synthesis routes, theoretical models and measurement results were obtained. Further exploration of the magnetoelectric properties, and focus on promising families will continue. Publications are in progress.

Future Work

- Complete the phase diagram of TNNYCH₃CN and compute the electric polarization in order to compare our results with the future experiments by Yasu Takano that are described in the progress report.
- Propose a model and compute the corresponding phase diagram for the new trimer compound that was recently synthesized by the experimentalists in our team.
- Provide theoretical input for the new metal-organic multiferroic that Nathan Smythe is producing in his new lab.
- Continue exploration of new materials including the La_{1-x}Sr_xCoO₃ family of spin-state transition materials, and magnetic variants of the ferroelectric tris-sarcosine calcium chloride.

Conclusion

Our deliverable will be an enhanced understanding of spin-state transitions and their coupling to the crystal-line lattice and its electrically polar properties, as well as new metal-organic materials and materials approaches to magneto-electric coupling. The applications of magnetoelectric coupling are devices such as computer memory,

filters, sensors, and antennas. Our approach achieves magneto-electric coupling with less power dissipation than existing spintronics devices due to the insulating nature of our materials.

Publications

Jain, P., A. Stroppa, S. Picozzi, A. K. Cheetham, H. W. Kroto, N. S. Dalal, A. Marino, A. Rubano, D. Paparo, M. Matsubara, M. Fiebig, and V. S. Zapf. Multiferroicity in the metal-organic framework $[(\text{CH}_3)_2\text{NH}_2]\text{Mn}(\text{HCOO})_3$ with perovskite ABX_3 architecture: a combined experimental and ab-initio study. *Journal of the American Chemical Society*.

Kamiya, , and C. D. Batista. Magnetic Vortex Crystals in Frustrated Mott Insulator. 2014. *PHYSICAL REVIEW X*. 4 (1).

Lin, , Barros, Mun, Kim, Frontzek, Barilo, S. V. Shiryayev, V. S. Zapf, and C. D. Batista. Magnetic-field-induced phases in anisotropic triangular antiferromagnets: Application to CuCrO_2 . 2014. *PHYSICAL REVIEW B*. 89 (22).

Mun, E. D., Chern, Pardo, Rivadulla, Sinclair, H. D. Zhou, V. S. Zapf, and C. D. Batista. Magnetic Field Induced Transition in Vanadium Spinel. 2014. *PHYSICAL REVIEW LETTERS*. 112 (1).

Mun, E. D., J. Wilcox, J. L. Manson, B. Scott, P. Tobash, and V. S. Zapf. The Origin and Coupling Mechanism of the Magnetoelectric Effect in $\text{TMCl}_2\text{-4SC}(\text{NH}_2)_2$ (TM = Ni and Co). 2014. *Advances in Condensed Matter Physics*. 2014: 512621.

Zapf, , Jaime, and C. D. Batista. Bose-Einstein condensation in quantum magnets. 2014. *REVIEWS OF MODERN PHYSICS*. 86 (2): 563.

Zhu, S., Y. -Q. Li, and C. D. Batista. Spin orbit coupling and electronic charge effects in Mott insulators. To appear in *Physical Review B*.

Beyond the Chemical Reaction Zone: Detonation Product Gases in the Warm Dense Regime

Dana M. Dattelbaum
20140261ER

Introduction

The chemical reaction zone behind a detonation front comprises a dense fluid mixture of components such as N₂, CO₂, CO, CH₄, and NH₃, at densities ranging from 0.09 to 1.5 g/cm³. There is considerable overlap between the constituents of detonation product mixtures and those of planetary ices and atmospheres. Conditions relevant to planetary physics are often those of the warm dense matter (WDM) regime: too dense for weakly-coupled plasma models but too hot for standard condensed matter techniques. While these states are hotter and denser than those of the chemical reaction zone, multiple shocks may readily carry the product mixture through the WDM and into the dense plasma region: standard SESAME tables extend to $T \sim 10$ keV and $\rho/\rho_0 \sim 106$. Despite their vital importance in these contexts, however, molecular dissociation and ionization at elevated pressure and temperature are poorly characterized and constitute a significant source of potential error in our equations of state. To address these gaps, we will establish a synergistic experiment-theory-simulation effort focused on quantifying the P-V-T surfaces, and associated dissociation and ionization processes for the principal detonation product species: N₂, CO₂, CH₄ and NH₃.

Benefit to National Security Missions

The successful execution of this experimental-theoretical project provides critical and foundational data and models for improved confidence in weapons simulations. This project will enable rapid development of the experimental and theoretical tools to demonstrate transformational improvements in the treatment of detonation product gases. The results of this project are relevant to the National Boost initiative, Predictive Capability Framework, and objectives of DOE/NNSA Campaigns 1, 2, and Advanced Certification. In addition, the fundamental data obtained is relevant to planetary physics, and definitions of the conditions of the large gas giant planets.

Progress

The focus of the first year has been on shock compression of gas phase ammonia on the LANL two-stage large bore light gas gun coupled with diagnostics of temperature, dissociation and ionization. To this end, we have developed a gas loading system for ammonia (and methane etc.), obtained required safety approvals, and hired a new staff member to join the project. The experiments employ symmetric impact conditions to multiply shock the gases from < 1 GPa to pressures approaching 1 Mbar.

We have assembled a time- and wavelength-resolved optical spectroscopy apparatus with enhanced sensitivity in the UV-blue spectral region (250-400 nm) that we intend to use for time-resolved studies of the optical emissions from simple molecular gasses (NH₃, CH₄) under shock compression. The setup consists of a streak camera equipped with a UV-blue enhanced sensitivity photocathode coupled to a spectrometer. Emission from the shocked target is collected with a fused-silica optical fiber that is coupled to the spectrometer input. We tested this setup using the line output of a low-pressure mercury-argon lamp and have verified that the spectral sensitivity of the entire setup (including the optical fiber) extends down to ~ 250 nm. The setup has been used to monitor the optical emission from two argon gas shots. The featureless emission spectrum that we have observed is characteristic of a blackbody emitter at 13,000 °K. In preparation for our first molecular gas shot (NH₃), we have replaced the grating in the spectrometer with a lower dispersion grating that will allow us to monitor the optical emission of the shocked gas between 250-700 nm. A series of ammonia shots will be completed prior to the end of the fiscal year. In addition, we have tested LiF windows for optical transparency in contact with shocked noble gases, and proven a novel asymmetric target geometry designed to reach higher particle velocities in shocked gas samples. The first experiment employed a Ta impactor impacting a 304 SS/6061 Al

layered drive plate, imparting a high pressure shock into a noble gas.

In parallel, ab initio molecular dynamics simulations of NH₃ have been performed from 0.5-2.5 g/cc in density and 1000-10000 K in temperature. In order to verify that our limited simulation times and system sizes are adequate to reach chemical equilibrium, we've also been developing ab initio reactive Monte Carlo techniques.

Future Work

The objectives of the experimental effort are: 1) to quantitatively resolve the shocked states in N₂, CO₂, CH₄ and NH₃ on the principal Hugoniot, and along a quasi-isentropic path to very high compression ratios and temperatures, and 2) to determine at what conditions dissociation and ionization (and possibly metallization) occur, and attempt to measure spectroscopic evidence of dissociation products. On- and off-Hugoniot states in molecular gases will be achieved via gas gun-driven plate impact using a suite of high performance gas guns with impact velocities up to 8 km/s. The experimental program will consist of two directions. The first, and lower risk, are shock experiments on fluid (liquefied) species, with a focus on reaching higher compression-rate, off-Hugoniot states, and applying in situ spectroscopies for the first time. The second, parallel direction will be to apply our newly developed experimental approach on elevated density gases. To determine the temperatures along the compression path, and to measure dissociation and ionization in the gases, we have a variety of time-resolved optical spectroscopic tools at our disposal.

Ab initio molecular dynamics (AIMD) simulation will be performed at fixed (ρ, T) states matched to those of experiment. Average degrees of coordination (bonding) will be used to calibrate atomic fluid models that more effectively capture dissociation transitions. Ionization states, however, are very difficult to infer directly from AIMD, because the imposed periodic boundary conditions prevent electron density from actually leaving the simulation cell. Our initial approach to this problem will be to calculate electrical conductivity (σ) and interpret the degree of charge transport using the Drude model for a free electron gas.

Simulations of the plate impact experiments will be performed using PAGOSA, a three-dimensional Eulerian hydrocode used to simulate compressive flow and high strain-rate deformation.

Conclusion

The expected result of this program is a significantly improved modeling capability for simple molecular gases that are relevant to detonation products and weapons simula-

tions for the Laboratory. New EOS methodologies will provide a physics-basis to bridge the gap between compressed fluid and Thomas-Fermi-Dirac regimes. Furthermore, we will lead the field by applying a comprehensive suite of advanced spectroscopic diagnostics under shock conditions. Lastly, new models, based on experimental results, will be evaluated in the Eulerian code PAGOSA.

Topological Kondo Insulators

Joe D. Thompson
20140271ER

Introduction

Metals are materials in which there is a band of electronic states that is only partially filled, allowing electrons to flow easily in response to a weak electric field. In a pristine insulator, however, possible electronic states are fully occupied, and there is a large energy gap between filled and unfilled electronic states. As a result, no electrons are available to move in response to an electric field and, hence, the electrical resistivity is infinite. An entirely new state of electrons has been proposed that combines both electrically conducting and electrically insulating electrons in a single material. The concept underlying this state of electrons is highly non-trivial and relies on the mathematical notion of topology that 'protects' conducting electrons from acquiring the insulating behavior of the vast majority of other electrons. As long as time-reversal symmetry is preserved (that is, an electron with spin 'up' moving with momentum $+k$ is identical to an electron with spin 'down' moving with momentum $-k$), and there is strong coupling between the electron spin and the electron angular momentum, this very unusual state of electrons should appear. The goal of this project is to establish experimentally the validity of this idea of topologically protected conducting electrons in materials that are electrically insulating because of strong electron-electron correlations. Just as the theory is non-trivial, so is its experimental validation because of the inevitable complication of material's imperfections which produce responses that mimic those of topologically protected conducting electrons.

Benefit to National Security Missions

The theoretical proposal that certain materials should have electrically insulating interiors but electrically conducting surfaces has profound implications for our basic understanding of how electrons can organize themselves as a consequence of rules of quantum mechanics. Experimentally validating this theoretical proposal in materials where strong electron-electron interactions also are present would open opportunities for manipu-

lating electrons for energy applications, such as thermoelectric cooling, as well as for discovering an exotic state in which elementary charge carriers act as their own antiparticles, so-called Majorana fermions. This project is primarily one of discovery science, focused on understanding the fundamental consequences of theoretical predictions that also have implications for new interpretations of electronic behaviors in plutonium-based materials. But, research will be pursued as well with potential technological applications in mind, including the use of those discoveries in the development of new spin-based logic devices that have broad relevance to DOE energy and defense missions.

Progress

Work during the first eight months of this project have focused on initial development of experimental techniques, thermal conductivity as a function of temperature and applied magnetic field and temperature-dependent electrical resistivity measurements at applied pressures to 2 GPa, as well as on preliminary measurements on the proposed topological Kondo insulator SmB6 as a function of controlled disorder. In particular, we have constructed an apparatus to measure the thermal conductivity of sub-millimeter sized crystals at ambient pressure in the temperature range from 1.8 – 50 K and in magnetic fields up to 9 T. This system has been tested extensively and accurately reproduces literature data for elemental metals and representative strongly correlated electron materials. The next, highly non-trivial step is to demonstrate that these measurements can be made at high pressures and to combine them with simultaneous electrical resistivity measurements. To this end, we have performed preliminary electrical resistivity measurements on test examples at pressures to 2 GPa and in the temperature range 1.8 to 300 K.

A completely unexplored test of the theoretically proposed topologically protected metallic surface state in SmB6 is to systematically damage its surface by heavy-

ion irradiation. Using the LANL ion-beam facility, we have irradiated the surfaces of SmB₆ with 10 keV and 20 keV Krypton ions, in the first case creating 0.15 displacements/atom (dpa) and in the second case 0.5 (dpa) and with further irradiation 1.0 dpa. That is, at 1.0 dpa every atom in SmB₆ has a probability of being moved from its initial position. By using low energy Kr-irradiation, we damage only the top $\sim 80\text{\AA}$ and 120\AA of the crystal at 10 keV and 20 keV, respectively. Resistivity measurements after each of these doses find no significant effect on the proposed protected metallic state. This is somewhat surprising. From what is known from theory of topological protection, this metallic state almost certainly should disappear if the surface is disordered to a depth roughly equal to an electronic mean free path, which is estimated to be $\sim 600\text{\AA}$ in SmB₆. We will test this theoretical concept.

Another manifestation of a possible topological protected state is the theoretical proposal that so-called Majorana fermions, electrons that are their own 'anti-electrons', should appear at the interface between a conventional superconductor and a topologically protected metallic surface. A signature of these Majorana fermions in this case is a Faunhofer-like pattern of the supercurrent flow through the interface. To explore this possibility, we have prepared an Al-SmB₆-Al junction, with Al being the conventional superconductor, and will search for this signature, which if there would be exceptionally strong evidence for a topologically protected metallic surface in SmB₆.

Future Work

To achieve our goal of experimentally validating the theoretical prediction of topologically protected electronic states in strongly correlated electron materials, we will continue efforts to develop a new capability to measure the effect of applied pressure on the temperature-dependent thermal conductivity of proposed topological Kondo insulator materials. By simultaneously measuring the thermal and electrical conductivity as a function of pressure and temperature, we will derive the ratio between these quantities, which will allow the separation of extrinsic and intrinsic contributions. In parallel, we will complete a study of the effect of surface-radiation damage on the electrical transport properties of SmB₆ and pursue the use of Al-SmB₆-Al junctions as a strong test of theoretically predicted manifestations of the topological nature of the Kondo insulator SmB₆. With this range of techniques, we expect to prove or disprove several theoretical predictions. If theory is proven to be correct, this work will lay the foundation for an entirely new field of research on strongly correlated electron materials and the substantial technological consequences of topologically protected quantum states of matter.

Conclusion

This project will establish a new field of research on electronic states that emerge in materials as a consequence of strong electronic correlations and that hold promise for enabling new technologies ranging from thermoelectric cooling and spintronic devices to quantum computing.

Semiclassical Modeling of Non-adiabatic Processes in Molecular Materials

Dima V. Mozyrsky
20140293ER

Introduction

Present day computational quantum chemistry and material science attempt to evaluate not only equilibrium properties of molecular materials, but also their dynamics under different physical conditions. For example, by absorbing a quantum of laser radiation a molecule goes to an excited electronic state, which may lead to various possibilities in its subsequent evolution: It may dissociate into new molecules or atoms or, emitting a phonon, it may go to a long-living excited vibronic state without splitting into new molecules. Understanding and control over these processes (photoinduced pathways) lies at the heart of all our efforts to design functional photoactive materials for many technological applications. Such molecular dynamics is inevitably accompanied by the transitions between neighboring electronic states in a molecule that are not easy to describe within the existing approximation schemes. The majority of the existing schemes are either too computationally expensive or based on ad-hoc approximations that lead to inconsistencies between quantum and classical mechanics. Therefore there is a clear need for a novel computational paradigm that, on one hand, would be sufficiently precise and based on well controlled physical approximations rather than ad hoc assumptions, and, on the other hand, would be computationally feasible to allow for efficient numerical simulations of molecular dynamics in realistic multi-atomic molecules. In this project we aim to accomplish this goal.

Benefit to National Security Missions

First and foremost our project upon completion will provide novel computational capabilities critical for understanding light-induced dynamics in many technologically relevant nanostructures. In fact, for the first time, experimental ultrafast spectroscopy will have its theoretical counterpart able to treat the material on the same footing. Consequently, we envision extremely broad applications of developed tools, relevant to the current and future LANL/DOE missions. Our project pri-

marily addresses Energy and Earth Systems LANL Grand challenge by providing computational means for molecular materials suitable for clean energy (solar energy capture and energy storage). Secondly, it strongly relates to Materials: Discovery Science to Strategic Applications challenge by discovering emergent phenomena in complex systems. The scope of the project is very broad and therefore we expect that it will provide a substantial boost to a number of already running programs and collaborations at LANL and worldwide. In particular we expect that the project will attract the attention of the world-wide community of spectroscopists and computational material scientists and will establish new collaborations with LANL and attract new CINT users.

Progress

During the first year of the project we have studied several questions related to the improvement of the sampling procedure used in the Monte Carlo algorithm that models non-adiabatic dynamics. In particular we have studied the dependence of numerical error due to the statistical nature of the algorithm on the number of trajectories used in the Monte Carlo samples as well as on the number of level crossings in the problem. Our results show that the error scales as an inverse square root on the number of trajectories with a proportionality coefficient that depends on the specifics of the problem as well as on the sampling procedure. We found that the dependence of this coefficient on the number of crossings is very strong, presumably exponential, and therefore one may need to modify the algorithm when dealing with problems with several level crossings. A possible route that we plan to explore is a combination of our approach with the multiple spawning method, where our Monte Carlo approach is used to model non-adiabatic dynamics in the vicinity of a single crossing, while the large scale dynamics is modeled with the multiple spawning method. Presently we are carrying out a study to reduce the value of this coefficient by a better sampling technique. We are considering sampling

protocols that involve hopping rates depending not only on the magnitude of the non-adiabatic coupling but also on the spacing between electronic surfaces to account for the phase variation of the integrands.

We have also addressed a question of rescaling of the velocity of the wavepacket after it “jumps” onto a neighboring electronic surface. A typical approach based on ad-hoc arguments is that only the velocity component along the non-adiabatic coupling vector should be rescaled when a jump between two electronic surfaces occurs. Our preliminary studies have shown that while this assumption is reasonable in many cases, generally the optimal rescaling procedure depends on the width of the wavepacket compared to the value of non-adiabatic coupling as well as the DeBroglie wavelength. We intend to carry out numerical simulations to confirm these studies. Finally we are preparing to publish these results in two papers within several months (before the end of the fiscal year).

Future Work

During the next fiscal year we intend to:

- Develop more efficient sampling protocols that will improve the accuracy of the Monte-Carlo procedure (i.e., a method of integral evaluation based on stochastic sampling of the integrand function). Such study will allow us to address systems with greater number of degrees of freedom.
- Include description of noise and dissipation effects. In the majority of experimental situations the forces produced by molecule’s surrounding medium (typically a solution) are sufficiently strong and may significantly modify the system’s dynamics. Accounting for such forces is, therefore, imperative for the reliable numerical simulation of realistic molecules in realistic physical conditions.
- Analytically study non-adiabatic dynamics in model systems with multiple nuclear degrees of freedom (e.g, spin-boson model) to better understand the semiclassical approximation used for the nuclear degrees of freedom. Specifically, we would like to understand the importance of energy conservation during hops between the adiabatic energy surfaces. This study may lead to the improvement of sampling protocols.

Conclusion

The major technical goal of this project is to provide a computational algorithm to evaluate molecular dynamics in situations involving transitions between different electronic states in a molecule. The algorithm will allow for a reliable and efficient evaluation of reaction pathways and

product ratios in a variety of problems of photoinduced molecular dynamics and will complement, and, in some cases, replace the existing approaches. We also intend to apply our method to study non-adiabatic dynamics in several molecular systems involving interaction of molecules with light relevant for photovoltaic applications.

Publications

White, A., V. N. Gorshkov, R. Wang, S. Tretiak, and D. Mozyrsky . Semiclassical Monte-Carlo: A First Principles Approach to Non-adiabatic Molecular Dynamics . To appear in The Journal of Chemical Physics .

Zhou, N., L. Chen, Y. Zhao, D. Mozyrsky, V. Chernyak, and Y. Zhao. Ground state properties of sub-Ohmic spin-boson model with simultaneous diagonal and off-diagonal coupling . To appear in Physical Review B.

Making nano-Mg a Reality

Irene J. Beyerlein
20140348ER

Introduction

With the need to reduce gas consumption, Mg alloys have risen to the top of the list as the next lightweight structural materials to replace steel. However, even if all the steel in your car (e.g., 30 mpg) were replaced with today's Mg, the weight reduction would boost fuel efficiency by only 54.6% (to 46 mpg), well below the Corporate Average Fuel

Economy standards for 2020 (61 mpg). But if the strength of bulk Mg were to increase ten-fold, the gas mileage would boost from 30 mpg to 76 mpg, leading to a transformational impact on the automotive industry. For other structural metals (e.g., Al, Cu, Ni, steel), up to ten-fold increases have been realized by severe plastic deformation (SPD) techniques, which transform coarse-grained metals to nano-grained metals. Unfortunately, all attempts to make "nano-Mg" in bulk sizes have failed. Bulk nano-Mg cannot be made because SPD causes deformation twinning in Mg. For this ER, we propose a breakthrough in microstructural processing by design, where the key is to create a composite of Mg and a smaller amount of second metal phase, metal X, such as Nb, Fe, or V, and tune the Mg-X interfaces to suppress twinning, permitting Mg refinement to the nanoscale. This innovative approach gives rise to new scientific

issues of Mg-X interface/defect processes. To tackle them, we pose two original hypotheses and use them to direct an integrated experimental and modeling strategy. By the end of the ER, we will deliver nano-Mg-X in bulk sheet form, wherein the Mg crystals are <100 nm in size. Being sought after for a decade, our bulk nano-Mg-X, as well as the science that enabled it and synthesis pathways that made it, will be in high demand by countless reputable research groups and industry (automotive, bio, and aerospace).

Benefit to National Security Missions

Being sought after for a decade, our bulk nano-Mg-X, as

well as the science that enabled it and synthesis pathways that made it, will be in high demand by countless reputable research groups and industry (automotive, bio, and aerospace). Nano-Mg-X will no doubt exhibit many other interesting properties apart from ultra high strength, such as corrosion resistance (aging), magnetism, conductivity, thermal stability, biodegradation resistance, and fracture toughness. Our project will fundamentally transform Mg research and manufacturing and make LANL the leader of this rapidly growing market. This ER notably fulfills all three pillars of LANL's Materials Strategy. 1) Defects and Interfaces: our innovation tunes interfaces to suppress emission of twinning dislocations. 2) Emergent Phenomena: all matter is controlled by their atomic structure and nearly 30% of nano-Mg-X will be Mg-X interface with a differing atomic structure than Mg or X. Hence new effects can be expected. 3) Extreme Environments: we exploit one extreme (severe strains) to produce nano-Mg-X, a material that will be tolerant in extremes of high stress, high strains (formable), and we expect, high temperatures.

Progress

Nanomaterials have been found to exhibit remarkable strength and, in some cases, simultaneous ductility. Nano-layered composites often achieve these exceptional properties while retaining good thermal stability. To realize these outstanding material properties in structural applications requires methods of fabricating nanomaterials in bulk form. Over the past few decades, severe plastic deformation (SPD) techniques, such as wire drawing, equal channel angular extrusion (ECAE), and accumulative roll bonding (ARB), have been employed to successfully make nanomaterials and nanolayered materials.

Nanostructuring (< 100 nm characteristic length scales) has been achieved mostly for cubic metals, such as face centered cubic (fcc) and body centered cubic (bcc) and composite combinations of the two, i.e., fcc-fcc and

fcc-bcc. Many technically relevant metals have a hexagonal close packed (hcp) structure, and to date, making bulk nano-hcp based metals has been a challenge with SPD techniques.

It has been notoriously difficult to make nano-scale hcp metals, such as Zr, Mg, and Ti, in engineering quantities. This is largely because hcp metals undergo deformation twinning. Our novel ER idea is to combine the hcp metal with a bcc metal to suppress twinning and create nanolayered hcp/bcc composites for the first time. During the first year of our project, we successfully developed a method using ARB to produce nanolayered Zr-Nb composites with nanolayered thicknesses h of ~ 90 nm.

To investigate the quality of the Zr-Nb interfaces, energy-dispersive spectroscopy (EDS) was utilized within the TEM. Surprisingly, EDS line scans on the $h = 92$ nm sample showed no signs of intermixing and showed chemically distinct, pure phases in the layers to within 4.5 nm from the interfaces.

To detect the role of deformation twinning, we measured the bulk textures for each phase at all length scales using neutron diffraction (see supplement). Neutron diffraction was carried out at the High Pressure Preferred Orientation (HIPPO) neutron time-of-flight diffractometer at the Los Alamos Neutron Science Center (LANSCE) at Los Alamos National Laboratory (LANL). Our analysis showed that deformation twinning was successfully suppressed.

It was not known before that dislocation-mediated plasticity free of deformation twinning could persist in hcp Zr down to the nanoscale. Our progress to date has already opened up an innovative route to manufacturing hcp-based nanostructured metals as well as a novel material for pioneering hcp/bcc interface and nanoscale hcp research. Interface characterization and interface modeling as described in our ER proposal are currently underway.

Future Work

The overarching goal of this project by the end of the three years is to develop a ground-breaking method for synthesizing nano layered composite metal that combines two phases, one metal with a hexagonal close packed (hcp) crystal structure and another metal with a body centered cubic crystal (bcc) structure. We aim to make this new material in bulk form using severe plastic deformation (SPD). The key problem is to make this material by modifying the hcp/bcc interfaces by different SPD routes. Our main innovation behind this plan is the recognition that deformation twinning is the chief obstacle that has prevented so many scientists before us from achieving this goal. We have already in the first year shown that we can

make Zr/Nb nano layered composites. In the next year, we plan to work our way towards making Mg/Nb composites. Toward this pursuit, we will make Mg-Nb nano layered composites via physical vapor deposition. The reasons for making thin films is to 1) test different chemical compositions of Mg and Nb, 2) to determine the deformation behavior via micro pillar testing, and 3) to modify the interface structures in a controlled manner. We will at the same time carry out atomic scale simulations to determine which interface structures are energetically favorable and which deformation slip mechanisms are preferred. Using this knowledge, we will perform crystal plasticity finite element (CPFE) simulations to understanding microstructure evolution during bulk deformation processing. While the modeling and micro pillar testing are being done, we will start in FY15 the bulk processing of Mg-Nb.

We plan to use standard Mg and Nb metals as raw materials. This initial processing effort is meant to establish a benchmark and basic understanding. We will redesign and update these efforts as the results from micropillar testing and simulation develop. All of these efforts are new and innovative and have not been performed or reported in the literature.

Conclusion

By the end of the ER, we will deliver 1) nano-Mg-X in bulk sheet form, 2) characterization of its nanostructure and mechanical properties, and 3) processing path designs for making nano-Mg-X in the form of bulk sheets and tubes. In addition, we will offer new understanding in the nascent field of hcp-X interfaces, the associated hcp-X interface models, and patentable SPD techniques.

Publications

- Ardeljan, M., I. J. Beyerlein, and M. Knezevic. A dislocation density based crystal plasticity finite element model: application to a two-phase polycrystalline HCP/BCC composites. 2014. *Journal of the Mechanics and Physics of Solids*. 66: 16.
- Ardeljan, M., M. Knezevic, T. Nizolek, I. J. Beyerlein, S. J. Zheng, J. S. Carpenter, R. J. McCabe, N. A. Mara, and T. M. Pollock. A multi-scale model for texture development in Zr/Nb nanolayered composites processed by accumulative roll bonding. 2014. *Journal of Materials Science and Engineering*. 63: 012170.
- Knezevic, M., T. Nizolek, M. Ardeljan, I. J. Beyerlein, N. A. Mara, and T. M. Pollock. Texture evolution in two-phase Zr/Nb lamellar composites during accumulative roll bonding. 2014. *International Journal of Plasticity*. 57: 16.
- Kumar, A., I. J. Beyerlein, and J. Wang. First-principles study

of the structure of Mg/Nb multilayers. 2014. Applied Physics Letters. 105: 071602.

Xu, X. F., Y. Jie, and I. J. Beyerlein. A note on statistical strength of carbon nanotubes. 2013. Computers, Materials & Continua. 38: 17.

Xu, X. F., Y. Jie, and I. J. Beyerlein. A probability model for the strength of carbon nanotubes. 2014. American Institute of Physics Advances. 4: 077116.

Toward Tunable Functionalities Using Epitaxial Nanoscaffolding Films

Quanxi Jia
20140371ER

Introduction

Lattice-strained epitaxial nanoscaffolding films (epi-NSFs), in which a parallel array of nanoscaled material A interfaces with another material B and forms a regular lateral arrangement of A:B on a substrate, provide a new design paradigm to tune/manipulate functionalities that cannot be obtained in individual constituents (A or B). Tuning/controlling functionality of a broad range of materials is emerging as an exciting direction in materials research community. Built on our expertise, integrated capabilities (from CINT, NHMFL, and T-4), and preliminary experimental results, this proposal aims to develop new capabilities toward tunable functionalities using epi-NSFs where the “vertical interface” can act as an “active device”. Specifically, we will, for the first time in the field, investigate the tunable optical and resistive switching properties based on $\text{La}_{0.7}\text{Sr}_{0.3}\text{MnO}_3:\text{ZnO}$ (LSMO:ZnO) and $\text{SrTiO}_3:\text{Sm}_2\text{O}_3$ (STO:SmO) epi-NSFs, respectively. The impact of this project reaches far beyond these materials systems.

Leveraging CINT’s well controlled laser-MBE for the growth of complex metal-oxide films, we target to synthesize both LSMO:ZnO and STO:SmO epi-NSFs with controlled microstructures. In parallel with T-4’s modeling effort, we also use computational results to guide the fine adjustment of processing parameters (which can affect the surface morphology of the film) and to tune the optical properties of ZnO and resistive switching property (or so called “memristive” behavior) of STO. Combining NHMFL’s unique characterization tools (such as transport measurement and photoluminescence (PL) spectroscopy at a wide range of magnetic fields and temperatures) with CINT’s advanced TEM and high-resolution x-ray diffraction capability, Our objective is to establish the processing-structure-functionality relationship of epi-NSFs.

Benefit to National Security Missions

The proposed effort supports and strengthens the Labo-

ratory’s core scientific capabilities essential to discovering, understanding, and exploiting emergent phenomena in materials. In particular, this research develops/expands our key capabilities outlined in the EPM ER category, e.g. i) functional design and optimization, ii) novel control and metrology techniques exploiting emergent phenomena, iii) understanding mechanisms for control of material properties, and iv) synthesis and processing techniques that lead to control of emergent phenomena. Furthermore, this project enables the development of new experimental (advanced synthetic and diagnostic techniques) and theoretical capabilities to probe the state of complex nanoscale materials. This effort can ensure LANL’s continued and expanded leadership in nanostructured materials, innovative probing methods, and theoretical predication and design of new/improved functional materials.

The success of this project enables LANL to respond effectively to future BES calls since our proposed work directly addresses the Grand Scientific Challenge identified in the BESAC report: how do remarkable properties of matter emerge from the complex correlations of atomic or electronic constituents and how can we control these properties? Beyond BES, this work will have enormous ramifications in technological sectors such as memory and electro-optical devices. Finally, this work enables an important capability for MaRIE, since the ability to design, synthesize, measure, and model functionality at different length scales in complex materials is the central competence underpinning MaRIE’s M4 facility. Additionally, this work exploits and expands the capabilities at two LANL National User Facilities: CINT and NHMFL.

Progress

In this review period, we have made tremendous progress on different fronts. In the following, we highlight the progress from synthesis, characterization, and theoretical modeling.

We have used La_{0.7}Sr_{0.3}MnO₃:ZnO (LSMO:ZnO) nanocomposite films as a model system to demonstrate the role of film thickness in tuning the physical properties of nanocomposites. By using x-ray diffraction and transmission electron microscopy, we have successfully analyzed thickness dependent strain and microstructures. The magnetotransport properties of the nanocomposite films have been fitted by a modified parallel connection channel model, which is in agreement with the change of microstructure as a function of film thickness in nanocomposite films on r-plane sapphire. The strain analysis indicates that the variation of physical properties in nanocomposite films on LaAlO₃ is dominated by strain effect. These results emphasize the significant effect of film thickness on microstructures, strain, and functionalities. We have further performed preliminary magneto-photoluminescence of a LSMO/ZnO epi-nanoscaffold structure at temperatures down to 2K and in magnetic fields up to 7T.

We also developed nanoscaffold SrTiO₃:Sm₂O₃ memristors using vertical heterointerface nanocomposite films. Using electron energy loss spectroscopy (EELS), we found that oxygen deficient regions are readily confined at the vertical interface of the nanocolumns and the matrix, due to the change of both structural and chemical properties across the interface. In other words, engineering the oxygen vacancies at the nanoscale by means of nanoscaffold structures spatially confines the conduction channels at vertical interfaces and gives better control over the device performance with high uniformity and reproducibility.

Progress on the theoretical modeling has been made on the development of a phase field model that can predict microstructure evolution due to competing effects due to elastic, interfacial and dipolar interactions. In addition, we are able to incorporate the effects of interfaces, precipitates and inclusions. At the same time, work is in progress to conduct some ab initio studies on various transition metal oxides/substrate systems to gain insight into parameter values that potentially may serve as input to the phase field models.

Future Work

- Optimize the processing parameters to grow strained La_{0.7}Sr_{0.3}MnO₃:ZnO (or LSMO:ZnO) and SrTiO₃:Sm₂O₃ (or STO:SmO) epitaxial nanoscaffolding films (epi-NSFs) on different substrates such as LaAlO₃ and Nb-doped SrTiO₃ substrates using pulsed laser deposition.
- Characterize the structural properties of the films using high resolution x-ray diffraction and transmission electron microscopy.

- Study the transport properties (such as the current vs voltage and photoluminescence) of the films on different substrates. We expect to establish the structure-property relationship of these epitaxial films.
- Develop phase-field model to determine the competing interactions responsible for surface patterning such as nanomases, nanopillars, and nanocheckerboards.

Conclusion

Our integrated capabilities to design, synthesize, and characterize different epi-NSFs with a range of controllable and tunable properties make it possible to explore new physics. The proposed work in this project has also great technological impact on areas of functional materials for application in memories, photonic devices, and sensing components. The following outlines the expected scientific and technical results:

- Development of a set of principles to design epi-NSFs with targeted functionalities
- Demonstration of magnetic field tunable optical properties of ZnO in LSMO:ZnO epi-NSFs
- Illustration of much enhanced tunable memristive switching in STO:SmO epi-NSFs.

Publications

- Chen, A., M. Weigand, Z. Bi, W. Zhang, X. Lv, P. Dowden, H. Wang, J. L. MacManus-Driscoll, and Q. X. Jia. Role of microstructure and strain on the magnetoresistance of nanocomposite films. 2014. *Scientific Reports*. 4: 5426.
- Jia, Q. X.. Self-assembled epitaxial nanocomposite films: their strain control and functionalities. Invited presentation at New Mexico Tech. (Socorro, NM, 7 March, 2014).
- Jia, Q. X.. Effect of interfaces on competing interactions of functional complex metal-oxides. Invited presentation at Univ. of Connecticut. (Storrs, CT, 17 Oct. 2014).
- Lee, S. B., A. Sangle, P. Lu, A. Chen, W. Zhang, J. S. Lee, H. Wang, Q. X. Jia, and J. L. MacManus-Driscoll. Novel electroforming-free nanoscaffold memristor with very high uniformity, tunability and density. 2014. *Adv. Mater.* 26: 6284.
- Zhao, R., W. Li, J. H. Lee, E. M. Choi, Y. Liang, W. Zhang, R. Tang, H. Wang, Q. X. Jia, and J. L. MacManus-Driscoll. Precise tuning of (YBa₂Cu₃O₇)_{1-x}:(BaZrO₃)_x thin film nanocomposite structures. 2014. *Adv. Funct. Mater.* 24: 5240.

Developing Potentials for Atomistic Modeling of Defect Phenomena at Metal-Ceramic Interfaces

Steven M. Valone
20120053ER

Abstract

The goal of this project was to understand defect interactions with metal-ceramic interfaces at an atomistic level by means of a new, unified model for both metals and ceramics. Defects e.g., point defects or line defects (dislocations), interacting with complex interfaces, influence many interfacial properties and the resulting material performance. The response of metal-ceramic interfaces to defects, whether generated from fabrication, cascade damage from irradiation, or materials deformation processes, are complicated by the disparity in the materials in intimate contact. However many defects, their movements, and mutual interactions can not be observed directly via experiments due to the short-time scales involved. It is then desirable to understand the physical processes and dynamics at the atomistic level via simulations such as molecular dynamics (MD) and conventional or off-lattice-kinetic Monte-Carlo. All atomistic simulations require interatomic potentials to describe the interactions among atoms, or the bonding. Attaining this goal requires the development of a unified atomistic model for both metals and ceramics as a central objective. For mixed bonds environment such as the metal/ceramic interfaces, it is well known that there are charge transfer issues that have puzzled the atomistic modeling community for many years. How to tackle the issue with physical principles, and its potential impact on understanding mixed-material interfaces, prompts the writing of this ER project. A spin-off of broad importance to materials modeling will be high fidelity interatomic potentials that describe the metallic, ionic, and covalent bonds in one, unified model. The objective is to reduce to, or otherwise approximate, established models for these individual classes of materials.

Background and Research Objectives

Atomistic modeling capability is hugely important to predictive science capabilities in general. For complex materials in fact such models have not been developed because the material, physical, and chemical responses

to extreme environments cannot be captured by existing atomistic models. One particular problem with existing atomistic models has been an inability to capture charge transfer, charge transport, and charge separation processes. These processes show up in numerous applications such as corrosion of metals and alloys, metal-hydride reactions such as those that happened at the Fukushima power plant, hydrogen storage technologies, plasma-material interactions such as in fusion reactors, and charge separation in solar cells or photovoltaics. For this reason, the atomistic modeling community has been largely absent from these endeavors.

The essence of the problems can be described by considering the following situation. Suppose that a Ni-metal/Ni-oxide material is of interest for some reason. The nickel atoms in the metal have to be neutral, while those in the oxide are ionic. If more oxygen is added to the composite, more of the Ni metal will oxidize (aka rust) and the affected Ni atoms will have to transition from being neutral, conducting heat and electricity, and being deformable to cationic, insulating, and brittle. Certainly electronic structure methods can model some of this transition, but processes such as materials deformation or defect-electronic interactions require much larger physical and temporal scales than can be addressed for the foreseeable future.

Treatment of these issues can be traced to the earliest stages of quantum mechanics, most notably work from Slater, Pauling and Mulliken [1-3]. This project generalizes some of the work of Mulliken, where he introduces his concept of electronegativity, the energy required to add or remove an electron from an atom. We will describe the generalization below. Much later Hubbard also understood the importance of allowing electrons to pile up on one atom more than another [4], but did not relate the idea to Mulliken's work. Parr and Pearson understood the relationship [5], but thought that this "pile-up of electrons" event should be understood as

a second-order change (2nd derivative) in the number of electrons on an atom.

This project began with the realization that Hubbard, Parr and Pearson's "pile-up of electrons" was related to something other than the number of electrons. We could argue that it was related to the concept of covalency as is captured in the prototype for this concept, the Heitler-London wave function. The complement to covalency is ionicity. It was postulated to be related to what is broadly referred to as a "charge fluctuation". Mulliken and his successors represented both charge fluctuations and charge transfer with the electronic configurations $A^0 B^0$, $A^+ B^-$, and $A^- B^+$, where the superscripts denote the net charge on atoms A and B. Charge fluctuations, equal amounts of $A^+ B^-$ and $A^- B^+$, do not on average change the number of electrons on either atom.

We then postulated that ionicity was related to another variable that had been used in earlier atomistic models of metals. We note that ionicity neither had been identified in Mulliken's work even though it was present nor applied to atomistic models.

Mulliken's original idea about energy change with changing numbers of electrons (i.e. the chemical potential of an atom in a molecule or material) is still present in his thinking. The combination of changing numbers of electrons plus varying amounts of charge fluctuation in a single atomistic model allowed us to devise a new type of atomistic model that addressed materials composed of mixtures of metals and metal oxides (i.e. composites). Constructing the model would require further simplifications and methodology discovery to put together the information from both experiment and electronic structure calculations that are based on entirely different thinking.

Scientific Approach and Accomplishments

The standard contributions for an atomistic model have been accepted as the site energies, the energies of the atoms as they are in a molecule or a material that is different from what it is when they are isolated from everything else, plus interactions between sites. In most of the literature on atomistic models, it was assumed that this set of contributions was an assumption. Work previous to the project had shown that these contributions could be deduced as a basic fact from the structure of the most essential objects in quantum mechanics, the Hamiltonians. For molecules and materials, Hamiltonians can be decomposed or "fragmented" just this way.

The trick has been to allow the electrons on each atom to both change in number (charge transfer) and move around (charge fluctuation). We had to take care of the

pairings {chemical potential, number of electrons} and {Hubbard-U or Parr-Pearson hardness, ionicity}. For this reason, the main contribution to focus on was determined to be the site energies. To achieve this it was assumed that the diatomic states that Mulliken applied in devising his concept of electronegativity could be generalized to any number of atoms. A second assumption was that the number of electrons on each atom was independent of all of the other atoms. The development led to what we came to call the Fragment Hamiltonian (FH) model. These two assumptions produced the needed simplifications to generate FH atomistic models for Ni metal [6], and for Be/BeO composites [7].

Figure 1 shows how the model performs in capturing energy differences between crystalline phases of Ni. The model has shortcomings that are well known from foundational models of this kind for Ni [8]. The fixes used in the earlier model can be applied to the FH model. As part of the work on Be/BeO composites, we learned to decompose electron densities from existing electronic structure methods in a way that told us what the covalency. A schematic of the density decomposition is shown in Figure 2.

As we have refined the details of the FH model, the LAMMPS computer code (from SNL) has been duly modified to serve as the repository for the FH model. The code is being and has been used to estimate defect energies for more complex structures (relaxed surfaces, grain boundaries, vacancies) for both Ni and Be/BeO systems.

In addition, Pilia was able to identify the lattice parameters at which a metal-insulator transition occurred in lattices of 1, 2 and 3 dimensions [9]. As expected, this pattern, based on spatial dimensions, is observed in both Be lattices and BeO lattices and is expected in essentially all crystalline materials. These dimensional dependencies are important to capture in the model, both for reasons of fidelity and for validation with electronic properties. Our first effort to capture the opening and closing of an energy gap in the FH model was restricted to a 1d chain model. Two cases were considered. The first case corresponds to large lattice spacing and atomic-like energy levels. In this case, the hopping energies are close to zero (atoms are stuck in a neutral state). There are energy gaps between clusters of energy levels analogous to "HOMO-LUMO" gaps. The second case corresponds to a compressed lattice and bands of energy levels. In this second case, the same hopping energies were allowed to increase to values comparable to the gaps in the first case. The gaps closed in a way that is reminiscent to the way a multi-band tight binding model behaves.

An outgrowth of the FH model started in the last year of

the project. In the original proposal this outgrowth was not anticipated or planned for. We realized that we could stop one step short of generating an atomistic FH model. If we stop the model development at this earlier point, we end up with what is called an “effective” Hamiltonian. Effective Hamiltonians are used in many areas of condensed matter physics, chemical physics, and materials science to model phenomena that is too complex or to render simpler representations of key properties. One of these key properties is the charge transfer gap that controls conductivity in a material.

No existing atomistic model possesses the property of electrical conductivity. As a test of whether or not the FH model might retain this property, a one-dimensional chain of atoms was considered as a trial system. This work was done in collaboration with colleagues at the UNM Department of Physics and Astronomy. (Note: These collaborators were supported by CMIME, a BES Energy Frontier Research Center, not by LDRD.) Within conductivity, it is necessary for gaps in the energy spectrum to close to in order for electrons to move about freely enough to allow conduction.

From Figure 3, it is evident that the FH model is able to reproduce a process analogous to gap closure. It is therefore the only atomistic model in existence with this kind of property. Because we were able to capture some form of energy-gap closure in the FH model, a second problem was considered in the last few months of the project. The second problem was to determine if gap closure could also be achieved in a two-fragment system, the fragments could be something like a “donor-acceptor” material couple that appears in photovoltaic devices and elsewhere. In this problem, one has to compute ground state energies for the fragment pair in its cation, neutral and anion states. We pursued this example in order to follow the foundational work in this area for Hubbard models [10, 11]. The atomistic FH model was shown to recover the common adage in the solid-state physics community that the global, Parr-Pearson chemical hardness, or charge-transfer, gap closes when the energy gain by transport of electrons and/or “holes” overcomes the local, Hubbard-U gap [12].

Impact on National Missions

Atomistic modeling capability is hugely important to predictive science capabilities in general. Nearly every multi-scale modeling proposal around the world for the last 7 years assumes the availability of atomistic models for complex materials that in fact are not in evidence. Campaigns 1, 2 and 8, BES, Waste Storage programs (Veirs), and other LDRD projects have interests in the success of this project. Such new modeling tools will open new vistas for

coupling mechanical and electronic structure responses of nanoscale materials that we cannot attempt now because the atomistic models do not have the right physics and the electronic structure methods cannot accommodate the time and length scales of interfacial interactions and heterogeneity.

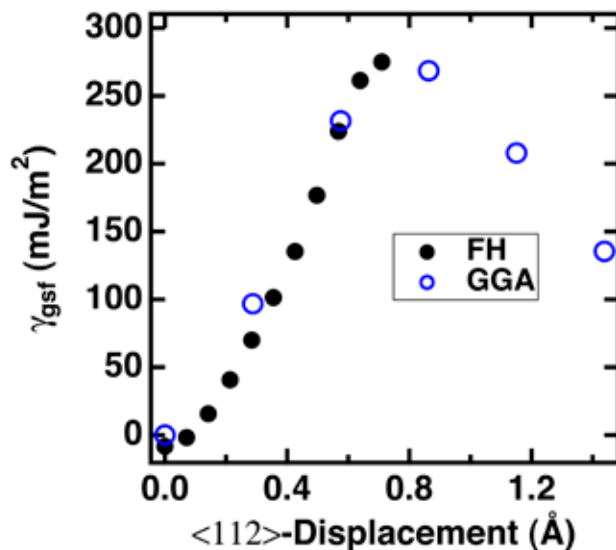

Figure 1. Properties of Ni structures based on FH model. (a) Unstable stacking fault energy in fcc Ni (the peak) is correctly predicted by the FH model as shown by agree with 1-principles electronic structure calculations. (b) Surface energies in FH model are poor compared to electronic structure predictions. This disagreement is expected.

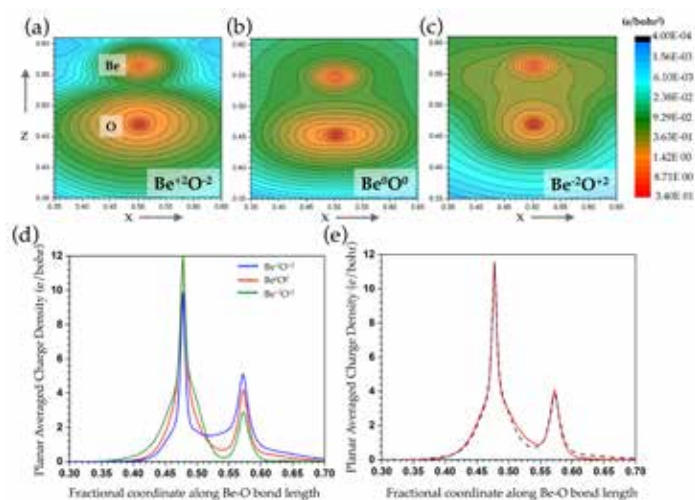

Figure 2. Two-dimensional charge density contour plots for the BeO diatomic at the equilibrium bond length of 1.33 Å. (a) cationic-anionic, (b) neutral and (c) anionic-cationic charge state densities. (d) Planar averaged valence charge density profiles for the three FH basis states. These averages are taken in planes normal to the axis of the molecule. (e) A comparison between the DFT-computed and fitted planar averaged valence charge density profiles.

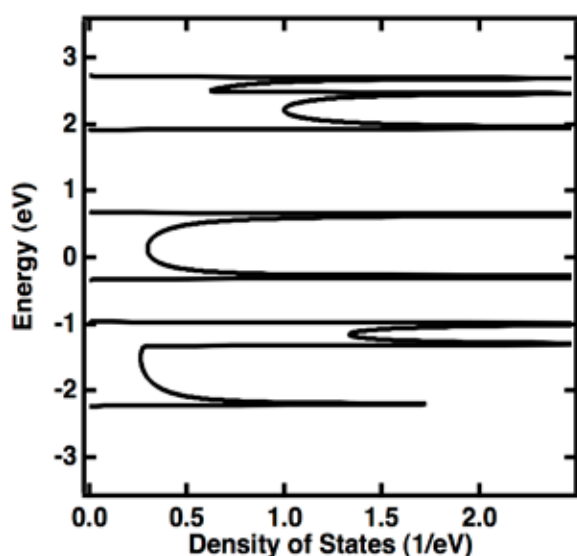

Figure 3. Plots of densities of states for in a one-dimensional chain. (a) Atoms in chain under tension, leaving gaps in their energy spectrum that influence heat and electrical conduction. (b) Atoms in chain under compression, closing gaps. Mechanical deformation can enhance or diminish properties.

References

- Slater, J. C.. Cohesion in Monovalent Metals. 1930. Physical Review. 35: 509.
- Pauling, L.. The Nature of the Chemical Bond. IV. The Energy of Single Bonds and the Relative Electronegativity of Atoms. 1932. Journal of the American Chemical Society. 54: 3570.
- Mulliken, R. S.. A New Electroaffinity Scale; Together with Data on Valence States and on Valence Ionization Potentials and Electron Affinities. 1934. Journal of Chemical Physics. 2: 782.
- Hubbard, J.. Electron Correlations in Narrow Energy Bands. 1963. Proceedings of the Royal Society London, Series A. Mathematical and Physical Sciences. 276: 238.
- Parr, R. G., and R. G. Pearson. Absolute Hardness: Companion Parameter to Absolute Electronegativity. 1983. Journal of the American Chemical Society. 105: 7512.
- Valone, S. M., S. R. Atlas, and M. I. Baskes. Fragment Hamiltonian Model Potential for Nickel: Metallic Character and Defects in Crystalline Lattices. 2014. Modelling and Simulation in Materials Science and Engineering. 22: 045013.
- Pilania, G., X. Y. Liu, M. I. Baskes, and S. M. Valone. Fragment Hamiltonian Model Potentials for Beryllium and Beryllium Oxide. 2014. In Preparation.
- Baskes, M. I.. Modified Embedded-Atom Potentials for Cubic Materials and Impurities. 1992. Physical Review B. 46: 2727.
- Pilania, G., X. Y. Liu, and S. M. Valone. First Principles Approach to Ionicity of Fragments. LA-UR-2014-24789.
- Lieb, E. H., and F. Y. Wu. Absence of Mott Transition in an Exact Solution of the Short-Range, One-Band Model in One Dimension. 1968. Physical Review Letters. 20: 1445.
- Lieb, E. H., and F. Y. Wu. The One-Dimensional Hubbard Model: A Reminiscence. 2003. Physica A: Statistical Mechanics and its Applications. 321: 1.
- Valone, S. M., G. Pilania, X. Y. Liu, J. R. Allen, T. C. Wu, and S. R. Atlas. Model Hamiltonians at the Atomistic Scale: Charge-Transfer Gaps and Gap Closure in Two-Site Systems. LA-UR-2014-27444.

Publications

- Kolluri, K., M. J. Demkowicz, R. G. Hoagland, and X. Y. Liu. Behavior of vacancies and interstitials at semicoherent interfaces. 2013. Journal of Metals. 65 (3): 374.
- Liu, X. Y.. Interphase Defects, Structures, and Phase Stability. 2013. Journal of Metals. 65 (3): 358.
- Pilania, G., X. Y. Liu, M. I. Baskes, and S. M. Valone. Fragment Hamiltonian Model Potentials for Beryllium and Beryllium Oxide. 2014. In Preparation.
- Pilania, G., X. Y. Liu, and S. M. Valone. First Principles Approach to Ionicity of Fragments. LA-UR-2014-24789.
- Valone, S. M., G. Pilania, X. Y. Liu, J. R. Allen, T. C. Wu, S. R. Atlas, and D. H. Dunlap. Model Hamiltonians at the Atomistic Scale: Charge-Transfer Gaps and Gap Closure in Two-Site Systems. LA-UR-2014-27444.
- Valone, S. M., K. Muralidharan, and K. Runge. Interatomic Potentials Including Chemistry. To appear in Multiscale Paradigms in Integrated Computational Materials Science and Engineering. Edited by Deymeir, P. A..
- Valone, S. M., S. R. Atlas, and M. I. Baskes. Fragment Hamiltonian Model Potential for Nickel: Metallic Character and Defects in Crystalline Lattices. 2014. Modelling and Simulation in Materials Science and Engineering. 22: 045013.
- Valone, S. M., and S. R. Atlas. Density and spectral-density matrices in atomistic-scale models. 2012. LA-UR-2012-22846.
- Yadav, S. K., R. Ramprasad, J. Wang, A. Misra, and X. Y. Liu. First-principles study of Cu/TiN and Al/TiN interfaces:

weak vs strong interfaces. 2014. *Modelling and Simulation in Materials Science and Engineering*. 22 (3): 035020.

Yadav, S. K., X. Y. Liu, J. Wang, R. Ramprasad, A. Misra, and R. G. Hoagland. First-principles density functional theory study of generalized stacking faults in TiN and MgO. 2013. *Philosophical Magazine*. 94 (5): 464.

First Principles Many-Body Approaches to Strongly Correlated Actinide Metals

Jianxin Zhu
20120232ER

Abstract

Since the early days of the Manhattan Project, it has long been a cherished goal, often thought impossible, to have an accurate first-principles, parameter-free, capability to calculate and predict, anywhere in the phase diagram, the materials properties of plutonium (Pu), which has an extremely anomalous metallurgy. The complexity of Pu metals is closely related to the unique position of Pu in the last row of periodic table, where the 5f electrons of Pu are borderline between being either itinerant or localized. This implies the presence of strong electronic correlation in these materials. To capture the electronic correlation effects, one must go beyond the density functional theory (DFT) within the local density approximation (LDA). On this aspect, the recently developed dynamical mean-field theory (DMFT) has made a breakthrough in understanding emergent phenomena in correlated electronic materials. However, the LDA+DMFT suffers from the weaknesses that the determination of screened local Coulomb interactions is highly nontrivial and these interactions are currently input as ad hoc model parameters in an uncontrolled way that is not based on any fundamental derivation.

In this project we outlined a realistic approach to accomplish a first-principles version of DMFT. It starts with the quasiparticle GW theory. In this framework, the screened local Coulomb interactions are calculated on the fly with no adjustable parameters. Therefore, the GW+DMFT can naturally overcome those weaknesses suffered by the LDA+DMFT. The development of this theory will thus form a fundamental basis for new advances in our understanding of the superconductivity, magnetic and heavy fermion behaviors, and many other anomalous properties of strongly correlated d- and f-electron materials. It will replace the “empirical” nature of current predictions with a new theory that has controllable approximations, and as such can be systematically improved. We focus this development on its application to actinide materials.

Background and Research Objectives

Conventional LDA band-structure methods [1] fail for materials that contain open atomic d- and f-orbitals with very localized wave functions. Such materials often exhibit many anomalous properties and are usually called strongly correlated electronic materials, since it is believed that the strong Coulomb electronic forces between these electrons cause them to dance around each other in a way that correlates all of their dynamical positions and velocities simultaneously. Over the last decade it has been shown that the key to developing an accurate first-principles theory of strongly correlated electronic materials is to focus powerful mathematical machinery upon the parts of the electronic structure (the d- and f-orbitals) that exhibit strong correlations while employing simpler methods for those parts that are more conventional (all the other orbitals). Such an approach is now within reach of a strongly dedicated effort to accomplish this.

The major goal of this project is to develop a new electronic structure method that is capable of accurately predicting the materials properties of actinide materials. Conventional LDA band-structure theories [1] are highly accurate in regimes where actinides act like conventional materials. However, it has long been recognized that strong electronic correlation effects generate very anomalous properties such as unusually large-volume expansions. Our goal is to develop a first-principles method that includes such correlation effects in a parameter free fashion, and the DMFT [2] has a better footing to be integrated.

Scientific Approach and Accomplishments

Our method takes the major advantages of GW theory, which enables a calculation of Coulomb interaction in a first-principles manner. It provides a natural framework for the integration of DMFT. We have made significant progress in understanding the electronic structure and other emergent phenomena in elemental actinide solids

and compounds.

We have introduced a new electronic quantity, the correlation strength, which is defined as a necessary step for understanding the properties and trends in strongly correlated electronic materials. We have applied this idea [3] to the different phases of elemental plutonium. Within the quasiparticle self-consistent GW approximation (QSGW), we have surprisingly found a universal scaling relationship, where the f-electron bandwidth reduction due to correlation effects is shown to depend only upon the local density approximation bandwidth and is otherwise independent of crystal structure and lattice constant.

We have then proceeded to develop the full GW including the spin-orbit coupling (GW+SOC). We have been able to apply the GW+SOC to investigate the electronic structure in Uranium (U), Neptunium (Np), and Pu elemental solids [4]. We have shown that the spin-orbit splitting leads to a unique manifestation of electronic correlation effects and the degree of electronic correlations depends on the inter-actinide distance. Further, the screened Coulomb interaction has also been found to scale with the inter-actinide distance.

To further exemplify the significance of this GW approach, we have performed in parallel an LDA+DMFT study on the alpha-phase of Pu [5]. The calculations have been carried out for the first time ever on the full 16-atom per unit cell alpha-phase structure. Our calculations have demonstrated that Pu atoms sitting on different sites within the alpha-Pu crystal structure have a strongly varying site dependence of the localization-delocalization correlation effects of their 5f electrons and a corresponding effect on the bonding and electronic properties of this complicated metal.

The above successes on elemental actinide solids has paved a critical step for us toward the implementation of non-perturbative quantum many-body approach into the GW method. The GW method has now been integrated into the full-potential linearized augmented plane method and we have also been working on to integrate it into the electronic structure software developed at Los Alamos.

To describe the emergent phenomena including heavy fermion, superconductivity and magnetism as driven by the electronic correlation in actinide compounds, we have developed GW-based spin-fluctuation theory. The method starts with the electronic bands obtained from the first-principles calculations within the density functional theory and builds in the electronic Coulomb interaction as input. As a first step, we focused on the electronic self-energy renormalization due to spin fluctuations with dynamical spin susceptibility evaluated self-consistently. The full electron

Green's function is obtained via the Dyson equation. The imaginary part of the Green's function gives the spectral function as a function of both momentum and energy. The latter is measured by angle-resolved photoemission spectroscopy (ARPES) and the integrated photoemission spectroscopy (PES) after the summation over momentum; while the dynamical spin susceptibility is measured by the inelastic neutron scattering. We first applied this technique to the spin susceptibility calculations in four isostructural superconducting actinide PuCoIn₅, PuCoGa₅, PuRhGa₅, and nonsuperconducting UCoGa₅ compounds [6]. These materials are abbreviated as 115 compounds. Our calculations show a strong peak in the spin-fluctuation dressed self-energy at around 0.5 eV in all materials, which is mostly crated by 5f electrons. These fluctuations couple to the single-particle spectrum and give rise to a peak-dip-hump feature, characteristic of the coexistence of itinerant and localized electronic states. Results are in quantitative agreement with photoemission spectra. Finally, we have also shown that the studied actinides can be understood within the rigid-band filling approach, in which the spin-fluctuation coupling constant follows the same materials dependence as the superconducting transition temperature.

We then focused on the comparison of electronic structure in UCoGa₅, which is so far the only actinide sample for which high resolution ARPES data (at Los Alamos) are available. By working with the experimentalists John Joyce and Tomasz Durakiewicz, we demonstrated that the high-energy dispersion anomaly as observed by ARPES on UCoGa₅, which was originally thought to belong to a conventional Fermi liquid family, can be adequately described by coupling between itinerant fermions and spin fluctuations arising from the particle-hole continuum of the spin-orbit coupling split 5f states of uranium [7]. These anomalies resemble the 'waterfall' phenomenon of high-temperature copper-oxide superconductors, suggesting that spin fluctuations are a generic route toward multiple electronic phases in correlated materials as different as high-temperature superconductors and actinides.

We have also investigated the spin-fluctuation mechanism of superconductivity in the presence of gapless or nodal quasiparticle states in the excitation spectrum of inter-metallic plutonium compounds PuCoGa₅, PuRhGa₅ and PuCoIn₅ [8]. Nodal quasiparticle states are well established in copper-oxide, and heavy-fermion superconductors, but not in iron-based superconductors despite numerous signatures for the presence of spin fluctuations. The latter superconducting family is proposed to acquire a rather unusual s_{\pm} wave pairing symmetry, which changes sign on different Fermi surfaces but lacks nodal excitations, and thus

remains under active scrutiny. In this work, we studied the pairing symmetry and mechanism of a new class of intermetallic, plutonium-based high-T_c superconductors and predicted the presence of a nodal s_{\pm} wave pairing symmetry for the entire family. Starting from a density-functional theory based electronic structure calculation we predicted several three-dimensional Fermi surfaces in this 115-superconductor family in qualitative agreement with the literature. We identified the dominant Fermi surface “hot-spots” in the inter-band scattering channel, which are aligned primarily along the nesting wave vectors $Q \sim (\frac{1}{2}, \frac{1}{2}, q)$, with $0 < q < 1/2$, measured in units of the inverse lattice constants times 2π , where degeneracy could induce sign-reversal of the pairing symmetry. Our first-principles-based spin-mediated pairing symmetry calculation was performed within the random phase approximation of the spin susceptibility and demonstrated that the s_{\pm} wave pairing strength is stronger than the previously thought d-wave pairing and more importantly, this pairing state allows for the existence of nodal quasiparticles. Finally, we predicted the shape of the momentum- and energy-dependent magnetic resonance spectrum for the identification of this pairing symmetry. As a consistency check, we calculated the differential conductance with first-principles-based electronic bands and confirmed that the s_{\pm} pairing is in agreement with recent Andreev reflection in point-contact spectroscopy measurements. The observation of a zero-bias conductance peak is therefore a signature of nodal states on the Fermi surface and consistent with both s_{\pm} and d wave pairing symmetries. Our findings will advance the development of a consistent theory of spin-mediated superconductivity by including the plutonium-based intermetallic actinides, which bridge the families of copper oxides, iron pnictides, and heavy fermions in terms of superconducting transition temperature and spin-fluctuation strength.

Impact on National Missions

The development of a new first-principles electronic-structure method for strongly correlated actinide materials that can accurately calculate effects of electronic correlations on physical properties at any given temperature and pressure will have immediate application in a variety of NW, energy, high-performance (exascale) computing, and IS&T missions at the Laboratory. In the energy arena, for example, this will enable accurate materials predictions for actinide oxide fuels. Once the basic method is established and validated, future program development will be needed to generalize it in order to calculate various specific materials properties of interest. For example, a phonon module should be developed so that effects of thermal vibrations on the free energy at finite temperatures can be calculated. The code should also be generalized and exploited as an accurate method to calculate phase diagrams of rele-

vant materials. Elastic constants and mechanical properties could also be calculated.

References

1. Martin, R. M.. Electronic Structure: Basic Theory and Practical Methods. 2001.
2. Georges, A., G. Kotliar, W. Krauth, and M. Rozenberg. Dynamical Mean-Field Theory of Strongly Correlated Fermion Systems and The Limit of Infinite Dimensions. 1996. Rev. Mod. Phys.. 68: 13.
3. Svane, A., R. C. Albers, N. E. Christensen, M. van Schilfhaarde, A. N. Chantis, and J. Zhu. The electronic correlation strength of Pu. 2013. Physical Review B. 87: 045109.
4. Towfiq, A., R. C. Albers, A. V. Balatsky, C. Friedrich, and J. Zhu. GW quasiparticle calculations with spin-orbit coupling for the light actinides. 2014. Physical Review B. 89: 035104.
5. Zhu, J., R. C. Albers, K. Haule, G. Kotliar, and J. M. Wills. Nodal s_{\pm} - wave pairing in the Pu-based 115 high-temperature superconductor family. Proceedings of National Academy of Sciences (USA). 4: 2644.
6. Das, T., J. Zhu, and M. J. Graf. Spin-fluctuations and the peak-dip-hump feature in the photoemission spectrum of actinides. 2012. Physical Review Letters. 108: 017001.
7. Das, T., T. Durakiewicz, J. Zhu, J. J. Joyce, J. Sarrao, and M. J. Graf. Imaging the formation of high-energy dispersion anomaly in the actinide UCoGa5. 2012. Physical Review X. 2: 041012.
8. Das, T., J. Zhu, and M. J. Graf. Nodal s_{\pm} - wave pairing in the Pu-based 115 high-temperature superconductor family. Proceedings of National Academy of Sciences (USA).

Publications

- Ahmed, T., R. C. Albers, A. V. Balatsky, C. Friedrich, and J. Zhu. GW quasiparticle calculations with spin-orbit coupling for the light actinides. 2013. arXiv.org.
- Ahmed, T., R. C. Albers, A. V. Balatsky, C. Friedrich, and J. Zhu. GW quasiparticle calculations with spin-orbit coupling for the light actinides. 2014. Physical Review B. 89: 035104.
- Ahmed, T., R. C. Albers, A. V. Balatsky, C. Friedrich, and J. Zhu. GW quasiparticle calculations with spin-orbit coupling for the light actinides. Presented at 2014 APS March Meeting. (Dever, Colorado, Mar. 2014).

- Albers, R. C., J. Zhu, A. Svane, N. E. Christensen, and M. van Schilfgaarde. The electronic correlation strength of Pu. Presented at 2012 APS March Meeting. (Boston, MI, Mar. 2012).
- Das, T.. Interaction induced staggered spin-orbit order in two-dimensional electron gas. 2012. *Physical Review Letters*. 109: 246406.
- Das, T.. Staggered spin-orbit order: A new paradigm of broken symmetry phase of matter. 2013. *Journal of Superconductivity and Novel Magnetism*. 26: 1673.
- Das, T.. Spin-orbit density wave: A new phase of matter applicable to the hidden order state of URu₂Si₂. 2014. *Philosophical Magazine*. : 1.
- Das, T.. Imprints of spin-orbit density wave in the hidden order state of URu₂Si₂. 2014. *Physical Review B*. 89: 045135.
- Das, T., J. Zhu, T. Durakiewicz, J. J. Joyce, and M. J. Graf. Materials specific electronic correlation effects and spectral weight 'hot spots' in inter metallic actinides. 2012. In 2012 MRS Spring Meeting. (San Francisco, 9-13 April, 2012). Vol. 1444, p. 169. Cambridge: Cambridge University Press.
- Das, T., J. Zhu, and M. J. Graf. Spin fluctuations and the peak-dip-hump feature in the photoemission spectrum of actinides. 2012. *Physical Review Letters*. 108: 017001.
- Das, T., J. Zhu, and M. J. Graf. The electronic structure and self-consistent spin-fluctuation corrections of inter metallic actinides. 2013. *Journal of Materials Research*. 28: 659.
- Das, T., J. Zhu, and M. J. Graf. Nodal s_±- wave pairing in the Pu-based 115 high-temperature superconductor family. *Proceedings of National Academy of Sciences (USA)*.
- Das, T., T. Durakiewicz, J. Zhu, J. J. Joyce, J. L. Sarrao, and M. J. Graf. Imaging the formation of high-energy dispersion anomaly in the actinide UCoGa₅. 2013. *Physical Review X*. 2: 041012.
- Das, T., and A. Rahmani. A renormalization-group study of the symmetry-breaking order parameters in spin-orbit coupled iridates and related systems. 2014. ArXiv.org.
- Graf, M. J.. Spin fluctuations and the peak-dip-hump feature in the photoemission spectrum of actinides. Invited presentation at MRS Spring Meeting. (San Francisco, Apr. 2014).
- Graf, M. J.. The Science, Spin-fluctuation induced nodal s-wave pairing in the Pu-115 superconductors. Invited presentation at ANS Plutonium Futures 2014. (Las Vegas, Sept. 2014).
- Graf, M. J.. Spin fluctuations and the peak-dip-hump structure in the photoelectron spectrum of intermetallic actinides. Invited presentation at Workshop on Competing Orders in Functional Materials and their Applications. (NORDITA, Stockholm, Sweden, June 2013).
- Graf, M. J.. Spin fluctuations and the peak-dip-hump structure in the photoelectron spectrum of intermetallic actinides. Invited presentation at Plutonium Futures – The Science 2012. (Cambridge, United Kingdom, July 2012).
- Graf, M. J., T. Das, and J. Zhu. Spin fluctuations, Fermi surface hotspots and nesting in PuCoGa₅. 2014. *MRS Proceedings*. : 1683.
- Nica, E. M., K. Ingersent, J. Zhu, and Q. Si. Quantum critical Kondo destruction in the Bose-Fermi Kondo model with a local transverse field. 2013. *Physical Review B*. 88: 014414.
- Ronning, F., J. Zhu, M. J. Graf, R. C. Albers, H. Rhee, and W. E. Pickett. Superconducting gap structure of the 115's revisited. 2012. *Journal of Physics: Condensed Matter*. 24: 294206.
- Svane, A., R. C. Albers, N. E. Christensen, M. van Schilfgaarde, A. N. Chantis, and J. Zhu. The electronic correlation strength of Pu. 2013. *Physical Review B*. 87: 045109.
- Zhu, J.. Electronic correlation effects in Pu metals. Invited presentation at The 5th International Workshop on Dual Nature of f-electrons. (Suwon, Korea, May 2014).
- Zhu, J., K. Haule, R. C. Albers, and J. M. Wills. First-principles study of the Kondo physics of a Pu impurity in a Th host. Presented at 2013 APS March Meeting. (Baltimore, MD, Mar. 2013).
- Zhu, J., R. C. Albers, K. Haule, G. Kotliar, and J. M. Wills. Site-selective electronic correlation in a-plutonium metal. 2013. *Nature Communications*. 4: 2644.
- Zhu, L., and J. Zhu. Singularity in self-energy and composite fermion excitations of interacting electrons. 2013. *Physical Review B*. 87: 085120.

Are Nanoscale Foams Radiations Resistant?

Jose A. Caro
20120250ER

Abstract

Our research focused on the development of fundamental understanding of the mechanisms of radiation damage creation and recovery, melt/re-solidification process, and effect of radiation on mechanical properties of nanoscale materials. A very successful experimental/computational campaign was launched, aimed at finding the boundaries of a radiation tolerance window, in particular, in the dose-rate and temperature dimension. We experimentally evaluated the retained radiation damage and structural changes in nanofoams as a function of irradiation conditions, and material size and shape. We found that outside the window of radiation endurance, damage appears in the form of vacancy-related stacking fault tetrahedra (SFT), and that SFT accumulation is dose-rate dependent.

Our work break new ground in discovering the basic physics of material response under radiation conditions where the architectural dimensions of the material are comparable to the typical collision cascade and dislocation sources. MD simulations of radiation damage gave us tremendous insight into atomic-scale structures generated in nano-materials during the collision cascade. Analyzing the mechanisms underlying defect formation in irradiated nanopillars, we found that SFTs are natural sources of dislocations within the ligaments composing the foam determining their mechanical response. Surprising results were revealed in atomistic simulations of tensile/compressive tests performed for model bi-continuous nanoporous gold (np-Au) structures. A substantial tension/compression asymmetry in yield was found for np-Au with ligament diameter $< 5 - 7$ nm, which is attributed to the surface stress that sets the filament under compression, providing a bias favoring yielding in compression. Using nanoindentation tests, we found that irradiation actually hardens np-Au foams with larger ligaments ($\sim 20-30$ nm), a result that we analyzed in terms of the role of SFTs on the deformation mode of foams.

Our research lead to improved understanding and control of defects and interfaces, which is a critical capability for the Laboratory's mission in energy security, specifically for the next generation of radiation tolerant materials.

Background and Research Objectives

In this project, a field that had not been pursued before was explored for the first time. In the search for materials with improved radiation and mechanical response, a new genre of material was proposed. By investigating surface derived phenomena in high surface nanoporous materials, a new understanding of radiation tolerance and strengthening was obtained, allowing for the design of new materials in applications, such as from composites, structural materials, and sensor components.

Clearly, our project objective was to test the assertion that the key to perfect radiation endurance is perfect recovery. A model was proposed that defines a window of radiation endurance for nanoporous materials [1], which depends on the combined effect of two length scales: (1) a characteristic ligament size as compared to the collision cascade size and (2) a diffusion length for defect annihilation relative to dose-rate. Inside this dimensional window, ligaments are sufficiently small that defect migration to the ligament surface happens faster than the time between cascades (ensuring radiation resistance for a given dose-rate), and still large enough not to be destroyed by the cascade induced melting. We set-up as major goal to achieve a fundamental understanding of the radiation tolerance, and mechanical properties under irradiation of high surface nanofoams as structures that can potentially open a door to a new class of ultra-high strength radiation tolerant materials. We achieved our goal by experimentally evaluating the retained radiation damage and structural changes in nanofoams as a function of irradiation conditions (ion energy, mass, dose and irradiation temperature) and material size and shape [2].

Based on a combination of computer simulations and experiments on irradiation and mechanical response of nano-scale foams, we were able to prove the two hypothesis driving this project, namely that 1) a window in the parameter space exists where these materials show radiation resistance due to the combined effect of the two length-scales mentioned above, and 2) that there exists an optimum ligament size at which nanofoams show ultra-high strength due to dislocation confinement effects. This part of the project was further developed by studying the mechanical properties of nanofoams under irradiation, where we found that hardness in gold nanofoams increases after irradiation, a result that we analyzed in terms of the role of defect formation, mainly stacking-fault-tetrahedra (SFTs) on the deformation mode of nano-scale foams.

Atomic scale computer simulations of radiation damage and recovery gave us tremendous insight into the analysis of the resulting structures induced in nano-materials, nanopillars and nanofoams, during the collision cascade [3,4]. The results of computational tensile and compressive tests for model bi-continuous nanoporous gold structures using atomistic simulations were compared [4] with prediction of scaling laws for coarser-scale foams and with experimental data. A surprising substantial tension/compression asymmetry in yield was found for nanofoams with ligament diameter $< 5 - 7$ nm, attributed to the surface stress that sets the filament under compression, providing a bias favoring yielding in compression.

Additional objectives were developed in the course of the project. We further extended our studies to the experimental evaluation of radiation effects on mechanical properties of nanofoams. The irradiated nano-structures were analyzed looking for correlations between irradiation conditions and resulting defect structures and properties [5]. An important accomplishment in this respect was to answer the question whether irradiation actually hardens or softens a nanofam with larger ligaments (ligament diameter $\sim 20-30$ nm). We set-up a proof-of-principle simulation and found that the yield strength of a network of filaments is lower than for isolated filaments, and appears unaffected by the presence of the SFT, but as the plasticity proceeds, SFTs act as obstacles to dislocation motion, inducing hardening in a similar way that would occur in a bulk material.

The strategy implemented took us to the next level in developing universal scaling equations for radiation and mechanical response of nanoporous foams. This progress will help in the design of high surface density porous structures at the nanoscale with ultra-high strength and radiation tolerance properties. This is a major scientific contribution that is expected to have a significant impact in the next

generation of high strength radiation tolerant materials.

Scientific Approach and Accomplishments

We focused on three main activities: one experimental, the other computational, and the third theoretical.

In a first experimental step, we found that defect accumulation behavior varied with radiation dose-rate in Ne⁺⁺ 400 keV ion-irradiated thin (100 nm-thick) np-Au foams. SFTs were observed when np-Au foams were irradiated at high dose-rate, but they did not seem to be formed in np-Au at low dose-rate irradiation. Using Molecular Dynamics (MD) we studied from the computational perspective, the radiation response of both, the elemental constituent of foams, i.e. gold nanopillars, and metallic nanoporous foams generated with a numerical synthesis method. Our simulations suggested that the formation of SFTs in individual ligaments is due to the collapse of vacancy clusters. We proposed a model to explain these observations.

We continued our investigations by experimentally addressing np-Au mechanical properties under irradiation. This was done via nanoindentation of 1-micron thick gold nanofoams deposited on a Au/Ti/Si multilayered substrate [5]. We performed sequential, 100 keV and 400 keV, Ne ion irradiations of at room temperature at high dose-rate for a total dose up to 4 dpa. Mechanical deformation under indentation of the specimens was investigated using a Hysitron TriboIndenter equipped with a Berkovich-geometry indenter.

Our nanoindentation tests showed that hardness increases after irradiation. Our simulations shows that SFTs act as obstacles to dislocation motion, leading to the conclusion that, contrary to our previous simulation, SFTs affect hardness by the standard dislocation-obstacle interaction. This fact suggests that computer simulations of pillar are not representative of the real bulk nanofoam, calling for computer simulations of more realistic geometries of gold nanofoams under compression.

We also studied the influence of cascade parameters on gold nanofoams radiation resistance. We explored the effect of cascade damage on np-Au caused this time by different ions, i.e. He, Ne and Kr, at room temperature, and at high, intermediate, and low ion dose-rates, to a total dose of 1 dpa. We determined the boundaries of our recently defined 'window of radiation tolerance', which relates material features such as ligament size and diffusion properties to irradiation properties such as pka energy, dose rate, and temperature. We concluded that in the region of the parameter space explored, we effectively cross a boundary separating regions of endurance and damage. We further extended our research to high strength radiation tolerant

materials that can operate at high temperature. A way to improve the thermal stability of nano-scale materials is via the addition of a thin coating. We investigated radiation effects on mechanical properties of alumina coated gold nanofoams. We confirmed that annealed alumina coated gold nanofoams were thermally stable at 400°C and set-up the experiment to investigate the effect of irradiation on their mechanical properties.

Impact on National Missions

Radiation effects in nuclear materials are a limiting factor in the development of advanced fission reactors and fusion/fusion-fission hybrid concepts as well as spacecraft systems. In nuclear reactors, materials are exposed to harsh environments of intense neutron flux and high radiation damage that cause materials degradation and failure.¹ In deep space and long-term missions, exposure to high radiation flux is a critical constraint in space systems design. The search of radiation tolerant materials focuses nowadays on the properties of interfaces as recombination sites for interstitials, vacancies, and transmutations debris. As interfaces naturally provide these recombination sites, materials research has focused on microstructures with high interface content. Interfaces have been shown to act as sinks for radiation-induced defects leading to a reduction in radiation hardening, and an alleviation of He bubble nucleation and growth. Two large families of such materials can readily be mentioned, those having a large amount of nanoscale precipitates, such as the nanostructured ferritic alloys (NFA) (or the oxide dispersed strengthened materials (ODS), with ultrahigh density of Y-Ti-O rich nano-features, and the multilayered nano-composites.

In this LDRD-ER, we work focused on a third alternative, namely, nanoporous materials. The work in our LDRD-ER breaks new ground in understanding the basic physics of foams at the nanoscale, and their response under radiation resistant conditions are achieved due to the unique architectural dimensions of the material with ligaments that are smaller than the typical collision cascade in bulk materials. The work lead to improved control of defects and interfaces, which is a critical capability for the Laboratory's mission in energy security, specifically at the nano-scale. It provides insight into the important role of interfaces and defects in the functionality of nano structured materials (Materials Genome Initiative). A close connection to MaRIE is set-in place on materials in extreme irradiation environments and places us in a strategic position to seek future funding from the DOE-NE, BES, and industry

References

1. Bringa, E. M., J. D. Monk, A. Caro, A. Misra, L. Zepeda-Ruiz, M. Duchaineau, F. Abraham, M. Nastasi, T. S.

- Picraux, Y. Q. Wang, and D. Farkas. Are nanoporous materials radiation resistant?. 2012. NANO LETTERS. : 3351.
2. Fu, E. G., M. Caro, L. A. Zepeda-Ruiz, Y. Q. Wang, K. Baldwin, E. Bringa, M. Nastasi, and A. Caro. Surface effects on the radiation response of nanoporous Au foams. 2012. APPLIED PHYSICS LETTERS. 101: 191607.
 3. Zepeda-Ruiz, L. A., E. Martinez, M. Caro, E. G. Fu, and A. Caro. Deformation mechanisms of irradiated metallic nanofoams. 2013. APPLIED PHYSICS LETTERS. 103: 031909.
 4. Farkas, D., A. Caro, E. Bringa, and D. Crowson. Mechanical response of nanoporous gold. 013. ACTA MATERIA-LIA. 61: 249.
 5. Caro, M., W. M. Mook, E. G. Fu, Y. Q. Wang, C. Sheehan, E. Martinez, J. K. Baldwin, and A. Caro. Radiation induced effects on mechanical properties of nanoporous gold foams. 2014. APPLIED PHYSICS LETTERS. 104: 233109.

Publications

- Caro, M., E. G. Fu, L. Zepeda-Ruiz, W. Mook, Y. Q. Wang, J. K. Baldwin, C. Sheehan, E. Bringa, M. Nastasi, and A. Caro. Radiation response of nano-scale gold foams. Invited presentation at 8th Pacific Rim International Congress for Advanced Materials and Processing (PRICM-8). (Waikoloa, HI, 4-9 Aug., 2013).
- Caro, M., E. G. Fu, L. Zepeda-Ruiz, Y. Q. Wang, J. K. Baldwin, C. Sheehan, E. Bringa, M. Nastasi, and A. Caro. Radiation effects in nanoporous gold. Presented at TMS Annual Meeting Symp. on Functional Nanomaterials. (San Antonio, TX, 3-7 Mar., 2013).
- Caro, M., E. G. Fu, L. Zepeda-Ruiz, Y. Q. Wang, K. Baldwin, E. Bringa, M. Nastasi, and A. Caro. Characterization of a window of radiation resistance in nanoporous gold. Presented at 2012 MRS Fall Meeting Symp. MM, Materials under Extreme Environments. (Boston, MA, 25 Nov. - 30 Dec., 2012).
- Caro, M., E. G. Fu, W. M. Mook, Y. Q. Wang, J. K. Baldwin, C. Sheehan, and A. Caro. Radiation effects on nanofoams mechanical properties. Invited presentation at MRS Fall Meeting Symp ZZ on Nanostructured Materials in Extreme Environments. (Boston, MA, Dec 2-6, 2013).
- Caro, M., J. Zhang, W. Han, Y. Q. Wang, J. K. Baldwin, and A. Caro. Radiation resistance of gold nanofoams: Influence of cascade damage parameters. Presented at 2014 MRS Fall Meeting, Symp. DD on Materials for Advanced Nuclear Technologies. (Boston, 30 Nov - 5 Dec, 2014).

Caro, M., W. M. Mook, E. G. Fu, Y. Q. Wang, C. Sheehan, E. Martinez, J. K. Baldwin, and A. Caro. Radiation induced effects on mechanical properties of nanoporous gold foams. 2014. *Applied Physics Letters* . 104: 233109.

Caro, M., W. M. Mook, E. G. Fu, Y. Q. Wang, J. K. Baldwin, C. Sheehan, L. Zepeda-Ruiz, E. Bringa, and M. Nastasi. Radiation effects on mechanical properties of nanoscale gold foams. Presented at CINT Workshop . (Santa Fe, NM, 24-26 Sep., 2013).

Farkas, D., A. Caro, E. Bringa, and D. Crowson. Mechanical response of nanoporous gold. 2013. *Acta Materialia*. 61: 3249.

Fu, E. G., L. Zepeda-Ruiz, M. Caro, Y. Q. Wang, E. Bringa, J. Baldwin, M. Nastasi, and A. Caro. Temperature dependent radiation response of nanoporous (np) Au foams. Presented at Computer Simulation of Radiation Effects in Solids COSIRES 2012. (Santa Fe, NM, 24-29 June, 2012).

Fu, E., M. Caro, L. A. Zepeda-Ruiz, Y. Q. Wang, K. Baldwin, E. Bringa, M. Nastasi, and A. Caro. Surface effects on the radiation response of nanoporous Au foams. 2012. *Applied Physics Letters*. 101: 191607.

Fu, E., M. Caro, Y. Q. Wang, M. Nastasi, L. Zepeda-Ruiz, E. Bringa, K. Baldwin, and A. Caro. Nanofoams Response to Radiation Damage. Invited presentation at CAARI 2012, 22nd Int. Conf. on the Application of Accelerators in Research and Industry. (Fort Worth, TX, USA, 5-10 August 2012).

Fu, E., M. Caro, Y. Q. Wang, M. Nastasi, and A. Caro. Irradiation Response and Stability of Nanoporous Materials. Presented at 18th International Conference on Ion Beam Modification of Materials (IBMM 2012). (Qingdao, China, September 2-7 2012).

Pena-Rodriguez, O., M. Caro, A. Rivera, J. Olivares, J. M. Perlado, and A. Caro. Optical properties of Au-Ag alloys: An ellipsometric study. 2014. *Optical Materials Express*. 4 (2): 403.

Wang, Y. Q., M. Caro, E. G. Fu, L. Zepeda-Ruiz, E. Martinez, W. M. Mook, M. Nastasi, and A. Caro. Mechanical stability of nanoporous gold under ion irradiation. Invited presentation at CAARI 2012, 23rd Int. Conf. on the Application of Accelerators in Research and Industry. (San Antonio, TX, May 25-30, 2014).

Zepeda-Ruiz, L., E. Martinez, M. Caro, E. G. Fu, and A. Caro. Deformation mechanisms of irradiated metallic nanofoams. 2013. *Applied Physics Letters*. 103: 31909.

Ultrafast Spectro-microscopy for Nanoscale Magnetic Domain Imaging

Richard L. Sandberg
20120278ER

Abstract

The goal for this project was to develop an ultrafast soft X-ray coherent diffractive imaging (CDI) microscope for magnetic materials. Developing this tool will now enable the characterization of magnetic inhomogeneity and its non-equilibrium dynamics in order to understanding the exotic properties of complex magnetic and other nanostructured materials. We developed a table-top high harmonic generation based source of soft X-ray (SXR) radiation that can capture element-specific magnetization dynamics at the spatial and temporal scales of electron-spin-lattice interactions (fs-to-ps). Our system uses time-resolved X-ray magnetic linear and circular dichroism microscopies (tr-XMLD/tr-XMCD) and is currently being used to unveil magnetic properties of a broad class of materials on the fundamental timescales of the underpinning physical processes. The magnetic x-ray CDI (mCXDI) microscope developed under this project is capable of imaging samples with near 50 nm resolution and has shown spectroscopic time-resolved relaxation and spin ordering through ultrafast SXR spectroscopy. Hence, this system is now able to fill the gap between electron, scanning probe, and optical photon imaging technologies and will provide an unprecedented combination of elemental specificity, sensitivity to ferromagnetic and anti-ferromagnetic spin ordering, and the ability to probe material dynamics at the fundamental space and time scales. The development of time-resolved X-ray dynamic imaging is still at the early demonstration phase and significant impact for ongoing and future LANL programs in nanoscale imaging of heterogeneous complex materials at LANL and worldwide is envisioned with this microscope.

Background and Research Objectives

Further progress in the understanding and exploitation of novel magnetic materials demands an extension of conventional microscopic methods to characterize their magnetic properties at both femtosecond temporal and nanometer spatial resolution. Recent advances

in tabletop ultrafast soft X-ray (SXR) sources and latest generation X-ray Free Electron Lasers (XFEL) have made ultrafast imaging of nanoscale processes a reality and new SXR techniques are constantly developing to probe the material dynamics associated with charge, spin or lattice ordering. We have developed a microscope that is specifically sensitive to dynamic magnetic spin in support of LANL's materials programs.

One of the great challenges in condensed matter physics is to understand and ultimately control the functionality of novel magnetic materials. The exotic properties of these materials emerge from strong interaction between charge, spin, and lattice degrees of freedom (DOF) and ensuing competition between several energetically near-degenerate orders that determines the ultimate properties of a particular material. The mechanisms of the order competition are still poorly understood and the final material state cannot be predicted. Multiple-order competition results in electronic, magnetic, and structural spatial inhomogeneities at sub-nanometer-to-micrometer scales [1,2] and nontrivial sub-picosecond dynamics [3]. It is widely believed that the observed spatial and temporal inhomogeneities are strongly coupled and hold the key to understanding of the novel properties of these materials. We have created a tabletop microscope that is capable of measuring nanoscale element-specific magnetization dynamics at the time scale of electron-spin-lattice interactions (fs-to-ps) that are crucial for understanding the exotic properties of novel materials. Our microscope is capable of using time resolved X-ray magnetic linear/circular dichroism (tr-XMLD/tr-XMCD) spectroscopies coupled with coherent x-ray imaging (CDI) techniques to provide unprecedented insight into the properties of bulk complex material and magnetic nanostructures. This tool is already showing sensitivity to antiferromagnetic (AFM) films, surfaces, and interfaces and has shown in recent experiments promise of measuring contrast changes across nanoscale (sub-100 nm) magnetic domain boundaries with magnetic coher-

ent diffraction imaging (mCDI). While we did not achieve our full goal of demonstrating time resolved nanometer scale imaging, we did make significant progress towards these goals and at the time of the writing of this report are conducting the first imaging experiments on magnetic materials.

Scientific Approach and Accomplishments

Our approach for this project was to build upon past experience from the PI and team in developing ultrafast laser based tools for time-resolved spectroscopy and imaging. We upgraded an existing laser system and built a custom CDI microscope entailing vacuum housings and fixtures, custom soft X-ray optics, a large area soft X-ray CCD, and nanopositioning stages. Furthermore, we also developed a custom iterative phase retrieval algorithm code called "PhaseFetch," written by our former student Jonathan Gigax, in order to reconstruct the recorded SXR diffraction patterns into high resolution images. In addition to these efforts, we pursued collaborative partnerships in order to provide us with samples and enable beam time at larger user facility light sources. Two such efforts include developing nanofabrication techniques for magnetic thin film samples through a user proposal with Quanxi Jia and John Nogan of the Center for Integrated Nanotechnologies and successfully competing for and receiving beamtime at the Stanford Synchrotron Radiation Laboratory (SSRL) at the SLAC National Accelerator Laboratory. These capabilities and efforts were recognized as important and will continue under the funded LDRD Directed Research project "Multiferroic Response Engineering in Mesoscale Oxide Structures" (20140025DR, PI – Q. Jia).

Currently, we have focused our efforts on studying the multiferroic material BiFeO₃ (BFO) that has coupled anti-ferromagnetic ordering with ferroelectric (electronic polarization) ordering at room temperature. We have studied systems of BFO and other systems with tabletop time resolved soft X-ray spectroscopy as well as XMLD/XMCD at the SSRL. We have also spent significant time preparing thin film samples for X-ray imaging studies and recently found a suitable recipe for preparing such thin films. Currently, we are conducting scattering and imaging experiments on thin film BFO on our tabletop system and have beamtime in December 2014 for follow-on imaging experiments at the SSRL. However, even our preliminary results have attracted much attention including invited presentations to the TMS 2013 Annual Conference in San Antonio, TX in March 2013 and to the upcoming 2014 LCLS/SSRL Users Meeting at the SLAC National Accelerator Laboratory to be held October 10, 2014 in Menlo Park, California. Furthermore, some of these results were presented at an invited seminar at the SLAC Photon Sciences Seminar in

April 2014. Furthermore, this interest lead to the invitation to write a review article of table-top coherent diffraction imaging that was published in September 2013 [4] (Sandberg, R. L., Z. F. Huang, R. Xu, J. A. Rodriguez, and J. W. Miao. "Studies of Materials at the Nanometer Scale Using Coherent X-Ray Diffraction Imaging." 2013. JOM. 65 (9): 1208-1220).

These developments have also attracted additional collaborators. Prof. Edwin Fohtung of New Mexico State University has begun collaborative experiments on our table-top system to study to magnetic ordering of gadolinium-iron multilayers that show exotic low temperature magnetic behavior. Furthermore, we hosted a collaborator, Dr. Guido Cadenazzi from the University of La Trobe, for several weeks and we conducted some novel experiments on a gold/chromium nanopatterned sample using the full bandwidth of our harmonic source. These experiments may enable single shot dichroic CDI which would be a major advance in the field and enable studying time resolved processes without scanning X-ray photon energy or polarization. We are currently analyzing the data and working on a few papers we expect to come from this work [5] (the first of which is Cadenazzi, G., B. Abbey, J. Gigax, N. Weisse-Bernstein, T. Holesinger, G. Rodriguez, S. Gilbertson, B. McFarland, and R. L. Sandberg. "Absorption dichroism from single exposure multi-harmonic coherent diffraction imaging." In Preparation (2014)). Additionally, this work is leading to a proposal for the DOE Early Career Award for which the PI submitted a pre-proposal this last month.

In addition, in support of this project we have developed a small optical laser based test bed for CDI that has allowed testing of algorithms and development of techniques. This system was developed by students Kim Nguyen (now an undergraduate at University of New Mexico) and post bachelor's student Matthew Tyson of Furman University. They will be presenting their results at the upcoming 2014 American Physical Society Four Corners Conference to be held in Orem, Utah in October 2014. They are also working on a manuscript for a paper based on these results [6] (Tyson, M. C., K. Nguyen, J. Gigax, R. L. Sandberg, and J. L. Barber. "Fresnel-regime coherent diffraction imaging." In Preparation 2014). Finally, many of the ideas generated during this project, including Fresnel-regime CDI recently demonstrated on the optical laser setup, were published in a recent paper [7] (Barber, J. L., R. L. Sandberg, C. W. Barnes, and R. L. Sheffield. "Diffraction imaging at large Fresnel number: Challenge of dynamic mesoscale imaging with hard x-rays." 2014 - Physical Review B. 89 (18): 184105). The impact from this project will continue in the upcoming publications and through the follow-on LDRD-DR project as well as a potential DOE Early Career Award.

Impact on National Missions

The development of a table-top system capable of ultrafast magneto-optical X-ray spectroscopy and coherent X-ray imaging is providing LANL with a novel capability to investigate the dynamics of the magnetic ordering in a broad class of materials at the fundamental time and spatial scales and will hopefully place LANL at the forefront of this field. While we are still analyzing data and writing up the exciting results we have obtained, already this project is having impact on LANL missions. This system has become an important characterization capability for MaRIE, LANL's future signature facility, since the ability to unravel functionality in novel materials with coherent X-rays is an important competence underpinning MaRIE's M4 facility. This work is directly addressing the LDRD Grand Challenge in Materials. In the long term, our work will be directly applicable to exploration of spin ordering in actinide and other mission-relevant materials, which aid in determine material functionality. Furthermore, development of ultrafast magnetic CXDI is now a unique capability for the LANL-based Center for Integrated Nanotechnologies and is attracting more users to this facility as is evidenced by our new collaborations with the University of La Trobe and New Mexico State University.

References

1. Qazilbash, M. M.. Mott Transition in VO₂ Revealed by Infrared Spectroscopy and Nano-Imaging. 2007. *Science*. 318: 1750.
2. Kohsaka, Y.. How Cooper pairs vanish approaching the Mott insulator in Bi₂Sr₂CaCu₂O₈. 2008. *Nature*. 454: 1072.
3. Chia, E. E. M.. Observation of Competing Order in a High-T_c Superconductor Using Femtosecond Optical Pulses. 2007. *Physical Review Letters*. 99: 147008.
4. Sandberg, R. L.. Studies of Materials at the Nanometer Scale Using Coherent X-Ray Diffraction Imaging. 2013. *JOM*. 65: 1208.

Publications

Barber, J. L., R. L. Sandberg, C. W. Barnes, and R. L. Sheffeld. Diffractive imaging at large Fresnel number: Challenge of dynamic mesoscale imaging with hard x rays. 2014. *Physical Review B*. 89 (18): 184105.

Cadenazzi, G., B. Abbey, J. Gigax, N. Weisse-Bernstein, T. Holesinger, G. Rodriguez, S. Gilbertson, B. McFarland, and R. L. Sandberg. Absorption dichroism from single exposure multi-harmonic coherent diffraction imaging. To appear in *In Preparation*.

Sandberg, R. L., Z. F. Huang, R. Xu, J. A. Rodriguez, and J. W.

Miao. Studies of Materials at the Nanometer Scale Using Coherent X-Ray Diffraction Imaging. 2013. *JOM*. 65 (9): 1208.

Tyson, M. C., K. Nguyen, J. Gigax, R. L. Sandberg, and J. L. Barber. Fresnel-regime coherent diffraction imaging.

Unlocking Plasmons in Graphene

Kirill A. Velizhanin
20120300ER

Abstract

Nanoplasmonics is a growing field of research with multiple promising applications ranging from surface enhanced spectroscopies to biological imaging and information processing. However, traditional plasmonic materials (e.g., gold or silver) are plagued by strong Ohmic losses resulting in very short plasmon lifetimes and propagation lengths. Charge-doped graphene is a novel metallic material with low losses due to weak electron-phonon coupling, low defect concentration and suppressed scattering on defects due to vanishing band-gap (Klein scattering). Accordingly, graphene is perhaps the only low-dimensional material with the promise of the long-range plasmon propagation. In this LDRD ER project we proposed to accurately study and engineer the plasmonic response of charge-doped graphene samples. During the course of the project we published 4 papers in peer-reviewed journals (one more is submitted, one in preparation), gave 4 invited and 3 contributed talks on our progress in understanding the properties of graphene plasmons. Specifically, we have developed a computational platform to simulate the optical response of graphene-based plasmonic metamaterials (e.g., arrays of graphene nanoribbons). Employing this platform, we carefully studied the efficiency of plasmon coupling to various defects (e.g., semiconductor quantum dots, graphene edge) and found the amazing efficiency of plasmon-photon coupling through such defects, which is critical for actual applications of graphene-based plasmonic devices. On the experimental side, we have developed multiple capabilities (CVD-based graphene growth, electron-beam lithography, polarized infrared spectroscopy) at LANL. Using these capabilities, we studied the plasmonic response of arrays of graphene nanoribbons of various geometries. The theoretical and experimental capabilities developed during the course of this project, as well as obtained understanding of unique plasmonic characteristics of graphene-based devices has directly targeted the “Materials for the Future” LANL Science Pillar.

Background and Research Objectives

Many unique properties of graphene - monatomic crystalline layer of carbon atoms - stem from its unique electronic structure. Specifically, its honeycomb lattice combined with the delocalization of π -electrons over the entire layer result in the electronic spectrum of a zero-gap semiconductor with “ultrarelativistic” electrons and holes [1]. Already this makes graphene enormously appealing from both the basic and application standpoints. However, what renders graphene even more attractive is the possibility to tune these properties in a wide range by patterning, chemical functionalization, doping etc. For example, shifting the position of the Fermi level with respect to the charge-neutrality point by applying the backgate voltage allows one to significantly increase the free carrier concentration, and, thus, turn graphene into a metallic material instead of a zero-gap semiconductor. The effective metallic character of a backgated or doped graphene leads to qualitative changes in its optical properties. In particular, collective excitations (plasmons) rather than single-particle excitations (electron-hole pairs) are expected to dominate the electronic response of graphene to optical perturbation.

Nanoplasmonics – the study of plasmons confined to metallic nanostructures- is a very rapidly developing area with possible applications ranging from surface enhanced spectroscopies to biological labeling and information processing [2-4]. However, the conventional plasmonic materials (i.e., noble metals) are plagued by intrinsically high Ohmic losses resulting in very short (a few femtoseconds) plasmon lifetimes [2-4]. High-quality graphene samples promise much longer plasmon lifetimes thus introducing a possibility to not only excite a plasmon but also to exploit it to, e.g., carry energy/information along the graphene sample [5]. Thanks to its unique electronic and optical properties, graphene is perhaps the only low-dimensional material with the hope of long-range plasmon propagation. Plasmonic excitations in graphene have been observed by several

groups to date [6-8]. What was missing however is the accurate and systematic study of the plasmon-photon interaction in graphene-based nanodevices with specific applications in mind. In intrinsic uniform graphene, typical plasmons wavelengths can be shorter by a factor of ~ 10 -50 than the photon wavelengths at the same frequency. While this is very interesting for multiple applications, such a large wavelength mismatch renders the efficient plasmon optical excitation (via a photon-to-plasmon conversion) a non-trivial task.

The goal of our project was to unlock the properties of graphene plasmons for practical optoelectronic and metamaterials applications. One of the most important efficiency characteristics of a graphene-based plasmonic device is the efficiency of plasmon excitation, i.e., the strength of the photon-plasmon coupling. Because of the plasmon/photon wavelength mismatch “defects” – inhomogeneities of graphene material – are needed to render this coupling non-vanishing. The efficiency of the plasmon excitation by various “defects” including semiconductor quantum dots near the surface of graphene and graphene patterning (e.g., arrays of graphene nanoribbons made by lithography) was one of the main themes of the project. A more basic goal was to study the effect of various defects and impurities on the electronic structure of graphene. This knowledge would clarify the effect of various loss channels on the lifetime and dispersion of various electronic excitation in graphene (including plasmons).

Scientific Approach and Accomplishments

Our scientific approach has incorporated both theoretical and experimental efforts to understand, manipulate and engineer the plasmonic response of graphene-based nanostructured materials.

Experiment. Chemical-Vapor Deposition (CVD) growth of graphene was established at LANL as a new capability in functional synthesis of carbon nanomaterials. High-quality samples of many square millimeters in size were obtained and characterized electrically and optically. To this end, top gold contacts as well as substrate gate contacts were established allowing the application of gate voltages up to 100V of either polarity. Reasonably high carrier mobilities (up to ~ 500 -1000 cm^2/Vs) were measured, signifying the quality of the samples. Optical measurements of the gate-dependent behavior of the graphene material were conducted in two complimentary Fourier-Transform Infrared (FTIR) spectroscopy systems – a newly acquired FTIR microscope and a vacuum-based FTIR system. The former allowed a high spatial resolution on the sample down to 10 micrometer square, while the latter provided a vacuum environment for the measurements. The largely equivalent

results obtained in these systems indicated substantial stability of the graphene layer to the environment, which is a positive feature for future applications of graphene.

To study graphene plasmons, an electron beam lithography (EBL) of graphene samples was developed at LANL via thorough parameter optimization of resist exposure, development, plasma processing followed by electrical and optical characterization. It was discovered that the reproducibility and quality of plasmon spectra are keenly dependent on the quality of the sample with each and every processing step properly optimized. This work is not fully finished even up to this day due to the extreme complexity of the process requiring sub-100 nanometer feature resolution on dielectric (intrinsic silicon) substrate EBL. Nevertheless in the samples obtained we observed gate-dependent plasmonic features in FTIR spectra, Figure 1. It was discovered that graphene plasmons strongly interact with the phonons (lattice vibrations) in the underlying substrate leading to hybrid plasmon-phonon modes featuring very interesting dispersion characteristics. This discovery led to the development of a novel idea of super-resolution imaging on a surface using such hybrid modes. This imaging modality may one day become the first far-field non-fluorescence based super-resolution imaging technology. In collaboration with UNM scientists we are currently pursuing the possibility of funding this new direction via external grants from both the Government and industrial entities.

Graphene plasmonic samples were also investigated in a custom-built Raman microspectroscopy system with the goal of uncovering any possible Raman signatures of graphene plasmons. The fact that such signatures were not observed suggests that our understanding of plasmon interaction with external radiation needs to be reevaluated. This work is currently in progress. Specifically, we are currently performing the theoretical analysis/simulations of Raman activity of confined plasmonic modes in graphene nanoribbons.

Theory. We have developed a computational platform to simulate various optical processes in graphene-based optical devices. This platform allows one to simulate the processes of multiple absorption, reflection/refraction in layered structures including plasmon-supporting graphene sheets. Furthermore, this platform allows one to introduce various inhomogeneities and nanopatterning to the graphene-based devices. The developed platform was first tested to assess the efficiency of photon-plasmon coupling mediated by semiconductor quantum dots near graphene [9]. This coupling was demonstrated to be surprisingly efficiently, which was later used by us to propose to exploit graphene as an efficient energy conductor where energy in the form of plasmons can be transferred to as far as a

few micrometers [5]. Very recently we further developed the computational platform to incorporate the coupling of graphene plasmons to excitons in semiconductor nanostructures (e.g., quantum wells) [10].

During the last two years, the patterning of graphene into an array of nanoribbons, Figure 1 and Figure 2(a), has become de facto a standard way to excite and study plasmons in graphene. The accurate theoretical analysis of plasmon size quantization in such arrays, including the interaction between nanoribbons, has not been accomplished before. We have just finished our work on such an accurate description of plasmons in graphene nanoribbon arrays [11]. Importantly, we found that various nanoribbon arrays with seemingly different parameters can be separated into universality classes so that the problem has to be solved numerically just once within each such class. By solving such numerical problem and tabulating the numerical results, we have completely solved the problem of plasmon size quantization in the arrays of graphene nanoribbons [11]. For example, Figure 1(b) shows the extra reflection phase (r.h.s. vertical axis) for a graphene plasmon being reflected off the nanoribbon edge within the array.

We have also studied the effect of the graphene impurities (e.g., adsorbate atoms and molecules) on the electronic structure of the charge-doped (i.e., metallic) graphene. Specifically, we have analyzed the efficiency of scattering of current-carrying electrons by such impurities [5], which is of critical importance for assessing (and ultimately maximizing) lifetimes of graphene plasmons. Peers have recognized the importance of this work as it was published in Physical Review Letters.

Impact on National Missions

This project has directly supported a LANL Materials Grand Challenge directed at “Control of electronic or photonic functionality...”. Further, this work supported ongoing efforts in T-Division and the Center for Integrated Nanotechnologies focused on understanding/manipulating optical plasmons for new applications. In particular, this work has brought new capabilities to CINT (high-quality CVD growth, EBL) that may be made available to new users, which directly supports our DOE-BES mission. Ultimately, the outcomes of this project could lead to breakthrough capabilities for optical switching, signal processing and active metamaterial applications that would be of interest to a variety of sponsors including BES, as well as lead to new intellectual property. The developed computational platform to simulate optical interactions with graphene-semiconductor quantum dots hybrid systems targets the “Energy Security” LANL mission since quantum dots is the

main constituent for proposed highly efficient and cheap photovoltaics developed at LANL (Klimov) and elsewhere. The external collaborations developed during the course of this project (T. Shahbazyan, JSU; K. Bolotin, Vanderbilt) will help strengthening the ties of LANL with leading researchers in academia.

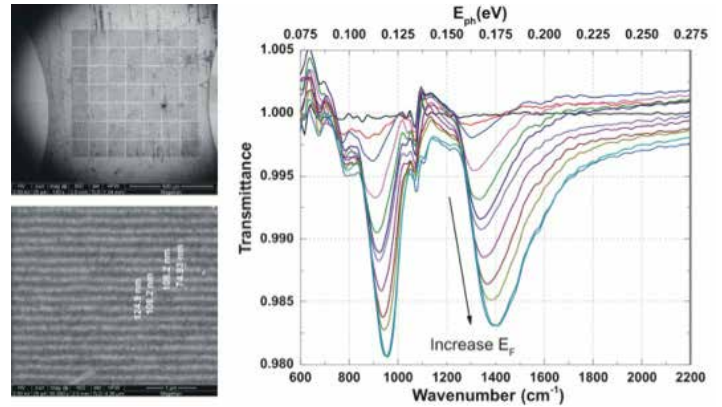

Figure 1. (left) SEM images of CVD-grown graphene nanopatterned by EBL into arrays of graphene nanoribbons. (right) Spectrally resolved infrared transmittance of nanopatterned graphene showing gate-dependent (both in frequency and in amplitude) plasmon-phonon hybrid modes.

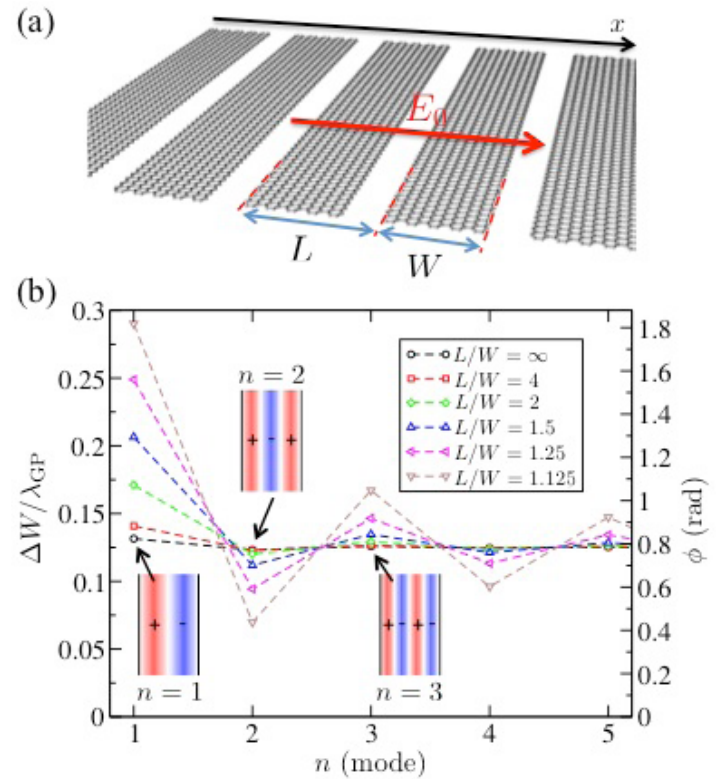

Figure 2. (a) GNR array with W and L being the GNR width and the width of the periodic unit, respectively. (b) Effective extra width normalized to the plasmon wavelength (left vertical axis) and the extra reflection phase (right vertical axis) versus the mode index.

References

1. Novoselov, K. S., V. I. Falko, L. Colombo, P. R. Gellert, M. G. Schwab, and K. Kim. A roadmap for graphene. 2012. *Nature*. 490: 192.
2. Abajo, F. J. Garcia de. Graphene Plasmonics: Challenges and Opportunities. 2014. *ACS Photonics*. 1 (3): 135.
3. Low, T., and P. Avouris. Graphene plasmonics for terahertz to mid-infrared applications. 2014. *Nano Letters*. 8 (2): 1086.
4. Grigorenko, A. N., M. Polini, and K. S. Novoselov. Graphene Plasmonics. 2012. *Nature Photonics*. 6: 749.
5. Velizhanin, K. A., and T. V. Shahbazyan. Long-range plasmon-assisted energy transfer over doped graphene. 2012. *Physical Review B*. 86 (24): 245432.
6. Fei, Z., G. O. Andreev, W. Bao, L. M. Zhang, A. S. McLeod, C. Wang, M. K. Stewart, Z. Zhao, G. Dominguez, M. Thiemens, M. M. Fogler, M. J. Tauber, A. H. Castro-Neto, C. N. Lau, F. Kielmann, and D. N. Basov. Infrared nanoscopy of Dirac plasmons at the graphene-SiO₂ interface. 2011. *Nano Letters*. 11: 4701.
7. Tegenkamp, C., H. Phnur, T. Langer, J. Baringhaus, and H. W. Schumacher. Plasmon electron-hole resonance in epitaxial graphene. 2011. *Journal of Physics: Condensed Matter*. 23 (1): 012001.
8. Yan, H., T. Low, W. Zhu, Y. Wu, M. Freitag, X. Li, F. Guinea, P. Avouris, and F. Xia. Damping pathways of mid-infrared plasmons in graphene nanostructures. 2013. *Nature Photonics*. 7: 394.
9. Velizhanin, K. A., and A. Efimov. Probing plasmons in graphene by resonance energy transfer. 2011. *Physical Review B*. 84: 085401.
10. Velizhanin, K. A., and T. V. Shahbazyan. Exciton-plasmaritons in graphene/semiconductor structures. 2014. *Physical Review B*. 90: 085403.
11. Velizhanin, K. A.. Geometric Universality of Plasmonic Modes in Graphene Nanoribbon Arrays. *Physical Review B*.
12. Solenov, D., and K. A. Velizhanin. Adsorbate Transport on Graphene by Electromigration. 2012. *Physical Review Letters*. 109: 095504.

Publications

- Solenov, D., and K. Velizhanin. Adsorbate Transport on Graphene by Electromigration. 2012. *Phys. Rev. Lett.* 109 (9): 095504.

Plasmon-Exciton Interactions in Single-Wall Carbon Nanotube – Metal Nanostructure Complexes

Han Htoon
20120330ER

Abstract

This project investigates the interaction of two different fundamental optical excitations, namely, 1D excitons of SWCNTs and plasmons (collective excitations of charge density waves supported by metallic nanostructures). We aim to manipulate various aspects of light-SWCNT interactions that hold the key to the realization of a variety of technological applications and to reveal never before seen phenomena that lie at the interface of classical electrodynamics and quantum mechanics. To date, our work has led to publication of 4 papers in J. Phys. Chem B, ACS Nano, Adv. Opt. Mat. and Appl. Phys. Lett. We are also preparing/revising 4 more papers and one intellectual property. Our results have also been highlighted in 18 invited and 5 contributed presentations at various major conferences. The accomplishments of this project includes: (1) Bringing a new level of understanding on how plasmons can effect exciton diffusion and localization in SWCNTs; (2) Utilizing this understanding in control of spectral diffusion (random wandering of PL emission peak) that is not desirable for generation of indistinguishable single photons for quantum communication; (3) Revealing key conditions that are needed for room temperature (RT) single-photon generation; (4) Discovery of a novel plasmon mode in graphene-giant nanocrystal hybrid system; (5) Unexpected discovery of a novel approach to create stable, highly emissive deep trap states in SWCNTs

These findings provide a foundation for us to respond a DARPA call, DARPA-BAA-14-46, in the areas of General Topic: Physical Sciences, and Multidisciplinary Topics: Transformative Materials. Our project simultaneously addresses a “LANL 2011 Material Grand Challenge”, “Understanding and Control of Emergent Functionality Using Extrinsic Techniques” as well as an “Energy and Earth System” grand challenge, “Concepts and Materials for Clean Energy.”

Background and Research Objectives

Interactions of two different fundamental optical excitations often lead to the emergence of new phenomena that cannot be observed in either of the original excitations. The interaction between an exciton and a plasmon represents one such instance. Phenomena that lie at the interface of classical electrodynamics and quantum mechanics such as enhancement of emission rates and exciton Rabi splitting have emerged in the study of this interaction in nanocrystal quantum dots[1] and semiconductor quantum wells.[2] In addition to being important for fundamental reasons, these phenomena exhibit tremendous potential for technological applications ranging from solid state lighting to quantum communication and information processing as they provide handles to manipulate not only spontaneous emission rates but also quantum coherent dynamics and photon emission statistics.

Although tremendous research efforts have been invested in the study of plasmon-exciton interaction in various nano-material systems, so far very few studies[3, 4] have been conducted on single-walled carbon nanotubes (SWCNTs), which have been regarded as the material of the future for their unique electrical, optical, and structural properties. Because of the SWCNT’s unique one-dimensional electronic structure, the manifestation of plasmon-exciton interaction is expected to be different at the fundamental level and therefore holds great potential for the emergence of unexpected phenomena. In addition, a comprehensive understanding of plasmon-exciton interactions could also result in transformative progress in the aforementioned technological applications of SWCNTs. To this end, we focused our study on:

Investigating the effects of plasmonic fields on diffusion, localization, recombination dynamics, electronic fine structures and symmetries of one-dimensional excitons.

Exploring new plasmon modes and plasmon-exciton

coupling mechanisms in SWCNTs and other carbon based nanostructures for realization of strong plasmon-exciton interactions.

Scientific Approach and Accomplishments

To date, our works have led to publication of 4 papers in *J. Phys. Chem B*, *ACS Nano*, *Adv. Opt. Mat.* and *Appl. Phys. Lett.* We are also preparing/revising 4 more papers and an intellectual property. Our results have also been highlighted in 18 invited and 5 contributed presentations at various major conferences/meetings and seminars. Below, we highlight the four most significant accomplishments of this project.

Influence of plasmons on diffusion and localization of one-dimensional excitons in SWCNTs

Toward accomplishing the first objective, we investigated the interaction of excitons in SWNT with atomically smooth gold pyramid substrates. Our wide-field photoluminescence microscopy images show that while the PL emission of a SWCNT is delocalized over its entire length, PL of a SWCNT trapped at the tip of the gold pyramid is observed to be localized to a diffraction limited spot. The back focal plane images of the free and coupled SWCNTs also show that the emission dipole of the SWCNT that usually lie along its length was turned upward (Figure 1a-1e). These results indicate that the plasmons localized at the tip of the pyramid can not only disrupt one-dimensional exciton diffusion but also change directionality of the emission dipole.

Motivated by these results, we developed a general theoretical approach to study exciton transport and emission in a SWCNT in the presence of a localized surface-plasmon (SP) mode within a metal nanoparticle interacting via near-field coupling. We derived a set of quantum mechanical equations of motion that account for the exciton, SP, and the environmental degrees of freedom. The material equations are complemented by an expression for the radiated power allowing for an examination of the angular distribution of the emitted radiation that is measured in experiment. Numerical simulations for a (6,5) SWCNT and Ag metal tip have been performed using this methodology. We found that the coupling to the SP accelerates diffusion, significantly affecting the exciton distribution profile, specifically, due to the fast energy transfer to the metal tip. Subsequently, the metal tip acts as a nano-antenna emitting photons with the rate order of magnitudes exceeding the exciton emission rate (Figure 1f). This explains the variation in the emission profile observed in the pyramid experiment. In addition, our theory predicts that the orientation of the emission pattern can be controlled by manipulating the exciton-SP coherences. Furthermore,

we have investigated the effect of the SP mode on the exciton intraband relaxation in SWCNTs and the radiation diagram. Another interesting aspect is charged carrier motion coupled to localized SP mode. Our theoretical study of this phenomenon showed large similarity in dynamics with the problem of polaron motion. Our quantum mechanical calculations revealed significant effect of the ponderomotive force experienced by the charge due to its interaction with quantum SP oscillations (including zero point mode) resulting in the formation of potential barrier controlling charge propagation along SWCNT. Practical implications of this effect include plasmonic field-effect transistors. These studies contributed to the Ph.D. Thesis of C. Cherqui. In addition a theoretical paper has been published recently in *J. Phys. Chem B* and two others are in preparation. These papers are expected to be finished by the end of 2014. This work includes collaboration with Prof. David Dunlap (D. Physics, UNM) and mentoring of a CINT theory postdoc O. Roslyak who is currently a tenure-track faculty at Fordham University.

Plasmonic manipulation of spectral diffusion

Next, we utilized this insight to manipulate an important light emission characteristic of SWCNT. Spectral diffusion or random wandering of PL emission peak has been observed not only in SWCNTs[5, 6] but also in wide array of nanoscale light emitters including nanocrystals,[7] and nano-rods.[8] This behavior is not desirable for light emitting applications that demand ideal spectral purity such as generation of indistinguishable single photons for quantum communication. The interaction between an exciton and fluctuating charges trapped in the vicinity of the nanoemitter has commonly been used to explain such a behavior.[7] While fluctuations of surface charges happening at a long time scales lead to a shift of emission peak, fast fluctuations contribute to spectral broadening. In the case of 0D quantum dots (QDs), the spectral diffusion-induced broadening dominates in defining spectral linewidths, yielding a sub-linear relation between spectral broadening (σ) and peak red-shift (ΔE).[7]

Unlike QDs, excitons in SWCNTs can diffuse hundreds of nm along their length at RT. Fluctuations of distance between the exciton and the surface charge can therefore dominate over the fluctuations of surface charge values in determining spectral diffusion. σ of the SWCNTs at RT, as a result, scale super-linearly with ΔE . However, when a SWCNT is cooled down to 4 °K, potential fluctuations along the SWCNT length become strong enough to trap the excitons within QD-like state and local charge fluctuations again dominate over the exciton-surface charge distance fluctuations. The relation between σ and ΔE again changed back to sub-linear (Figure 2. Top and middle

rows). Since our theoretical study revealed that interaction with localized plasmons can induce an effective localization of exciton, we hypothesized that σ of coupled SWCNTs-nano-antenna structures at RT should also scale sub-linearly with ΔE . To test this hypothesis, we investigated the spectral diffusion behavior of SWCNTs deposited on gold dimer nanoantenna array at RT. Data (Figure 2, bottom row) reveal that ΔE and σ indeed exhibit sub-linear relationship. This study brings a significantly new understanding on the correlations between exciton dimensionality and spectral diffusion revealing an interesting new way to achieve control of SWCNT photon emission properties. This work was recently published in ACS Nano.

Plasmonic effects on photon emission statistics of SWCNTs

Nonclassical light emission of single quantum emitters has been extensively investigated to develop single photon sources that are critically needed for realization of quantum communication. Recent studies have demonstrated such single-photon generation in SWCNTs at cryogenic temperatures.[9-11] Although SWCNTs are near perfect one-dimensional structures, single-photon emission reported in those studies is shown to originate from quantum-dot like zero-dimensional states formed due to localization of excitons. Since we now know that plasmon-exciton interaction can lead to exciton localization, here we explore whether such plasmon induced localization would enable RT single photon generation in SWCNT-nanoantenna coupled systems.

Because the processes controlling photon-emission statistics in SWCNTs at RT are poorly understood, we, first, examined them in details using stand-alone SWCNTs. The study was subsequently extended to SWCNT-nanoantenna coupled systems. Investigations of the stand-alone SWCNTs revealed conditions favoring RT single-photon generation. Specifically, we found that (1) a minimum photon-antibunching of 0.4 can be achieved for uncoupled SWCNTs with short exciton diffusion length (i.e. LD \sim 300nm) (Figure 3a); (2) while a complete photon-antibunching at RT in SWCNTs with long diffusion lengths would require a localization of excitons at a deep trap, it could be realizable in SWCNTs with short diffusion lengths by limiting the optical excitation to a region smaller than 200 nm (Figure 3b). On the other hand, SWCNT-nanoantenna coupled systems show that while nanoantennas could localize the excitons through enhancement in excitation and recombination rates, they cannot create a deep potential well that would enable trapping of excitons in true QD-like state. Coupling of SWCNTs to nanoantennas therefore is revealed to be unfavorable for single-photon generation (Figure 3c). These findings together could have strong impact not

only on fundamental photophysics of SWCNTs, but also on utilization of SWCNTs in single-photon generation critically needed for the realization of quantum communication. We are currently revising a paper reporting these results for publication in Physical Review Letters.

Discovery of a new plasmon mode in graphene-giant nanocrystal hybrid system

In achieving the second research objective, we focused on monolayer graphene as it has been rapidly emerging as an alternative two-dimensional plasmonic material.[12, 13] Our study of graphene-thick-shell nanocrystal QD (NQD) hybrid system has led to a discovery of a novel plasmon mode. Spectroscopic signatures suggesting the existence of such a plasmon mode has been observed in our recent optical study of CdSe/CdS core-thick shell colloidal giant-NQD (g-NQDs)[14] coupled to graphene. While the PL of individual g-NQDs on graphene are reduced by a factor of 3 compare to that of the g-NQD on glass, their PL decay rates were enhanced by a factor of 15. More surprisingly, our 2nd order photon correlation spectroscopy measurements reveal that the degree of photon bunching (a measure of relative emission efficiency of two-exciton states i.e. bi-exciton)[15] increases dramatically to values greater than 0.7 compared to 0.065 commonly observed for g-NQDs spread on glass (Figure 4a- 4d). To understand this behavior, we examine the effect of various decay channels induced by graphene on bi-exciton emission efficiencies. The analysis reveals that over an order magnitude enhancement of observed relative bi-exciton emission efficiency could be explained only if graphene enhances the radiative recombination rates of single and bi-exciton states. In our search for a possible mechanism explaining this unexpected rate enhancement, we discovered that a g-NQD photo-charged with about 2-3 electrons (a common behavior) can act as a nano-scale gate electrode and create a kink in the local chemical potential of graphene with the depth of about 2.0 eV and radius about 5 nm. A hole-puddle accumulated in such a kink is capable of supporting a plasmon mode that not only has resonance in the visible spectral range but also tremendously enhances the radiative rates of a nearby dipole (Figure 4e).

This discovery of a new plasmon mode has many important implications on the fields of plasmonics, photonic and quantum optics. Specifically, the extending the tunability of graphene plasmons to the visible spectral range facilitated by charging of g-NQDs could expand optical functionality of graphene plasmonics dramatically. Furthermore, because this new plasmon mode is formed directly underneath the g-NQD, it provides a perfect solution to a general problem of quantum emitter-plasmonic cavity alignment hindering a realization of strong plasmon-exciton coupling.

As a result, it may ultimately open a new route toward quantum plasmonics. This result was recently published in *Advanced Optical Materials*.

An unexpected discovery and ongoing activities

In attempts to couple SWCNTs into metal-SiO₂-metal plasmonic cavity, we unexpectedly discovered that encapsulation of the SWCNTs into a SiO₂ matrix leads to formation of highly emissive deep trap states 100 to 200 meV red-shifted from the original PL emission at 1.28 eV (Figure 5). These traps are observed to have an electronic structure identical to Oxygen doped SWCNTs. We theorized that oxygen radicals produced in the e-beam deposition of SiO₂ doped the SWCNTs. These states, as revealed by our study on photon statistics, possess tremendous potential for RT single-photon generation. We, therefore, are investigating photon emission statistics of these states and also exploring the possibilities to perform quantum plasmonic experiments. Currently, a manuscript summarizing these results is under preparation for submission to *Advanced Materials* and a patent should be filed soon.

Impact on National Missions

Our project simultaneously addresses a “LANL Material Grand Challenge”, “Understanding and Control of Emergent Functionality Using Extrinsic Techniques” as well as an “Energy and Earth System” grand challenge, “Concepts and Materials for Clean Energy.” This should also lead to systems level LANL opportunities and pave the way for future funding by BES and EERE within the DOE and by Homeland Security, ONR, DARPA for threat reduction and military applications. Specifically, Han Htoon and Steven K. Doorn are collaborating with Jennifer Hollingsworth to respond a recent DARPA call, DARPA-BAA-14-46, in the areas of General Topic:Physical Sciences and Multidisciplinary Topics: Transformative Materials.

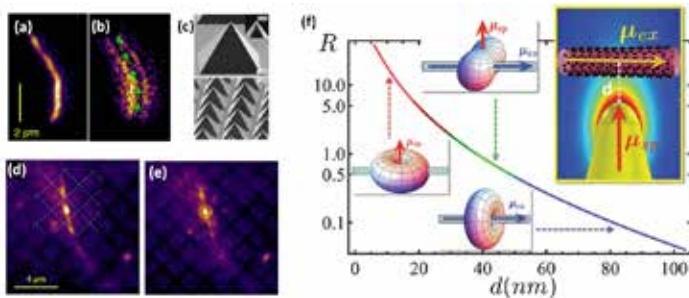

Figure 1. (a) Excitons freely diffusing along the length of a SWCNT emit nearly uniform PL. (b) A back-focal plane image shows that emission dipoles (green arrows) point along the long axis of the SWCNTs. (c) SEM image of an atomically smooth Au pyramid array. (d) A strongly localized emission is observed from the tip of a pyramid. (e) A back-focal plane image show the ring emission pattern indicative of a point dipole perpendicular to the tube axis. (f) Dependence of the SWCNT-SP emission pattern (sur-

face plots) and the ratio of photon fluxes from the metal tip to SWCNT (R) on distance between SWCNT and metal tip (d). Inset illustrates the near-field interactions between the exciton and SP dipole moments.

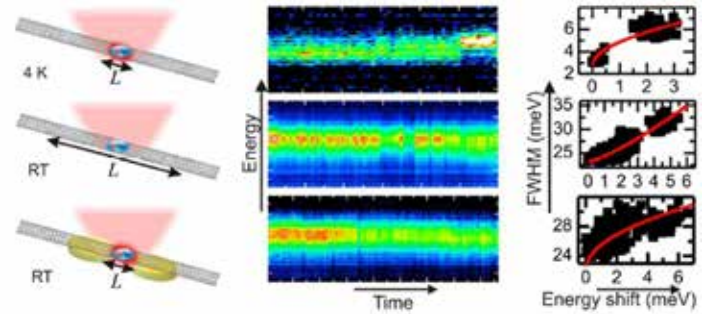

Figure 2. Top row: Excitons are localized to a QD-like state at low temperature. FWHMs and peak energy shifts extracted from the temporal evolution of PL spectra (middle column) show sub-linear correlation that can be fitted to a quadratic relation (right column). Middle row: At RT, excitons delocalize due to free 1D diffusion. FWHMs and peak energy shifts now exhibit super-linear scaling. Bottom row: When SWCNTs are coupled to gold nanoantennas, excitonic emission mainly originates from nanometer scale regions and excitons appear to be localized. PL spectral position and linewidths measured at room temperature, as a result, exhibit a sub-linear correlation.

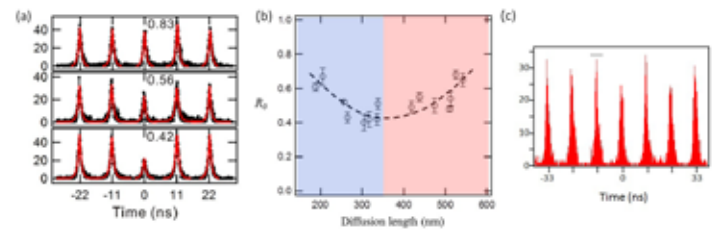

Figure 3. (a) 2nd order photon correlation function of a SWCNT at room temperature. Degree of antibunching (R_0) as low as 0.42 is achieved at the lowest pump fluence (bottom panel). (b) R_0 of different SWCNTs plotted as the function of exciton diffusion length. R_0 reach minimum when diffusion length becomes comparable to the excitation laser spot size. (c) R values greater than 0.8 were observed for SWCNTs coupled to nano-antennas.

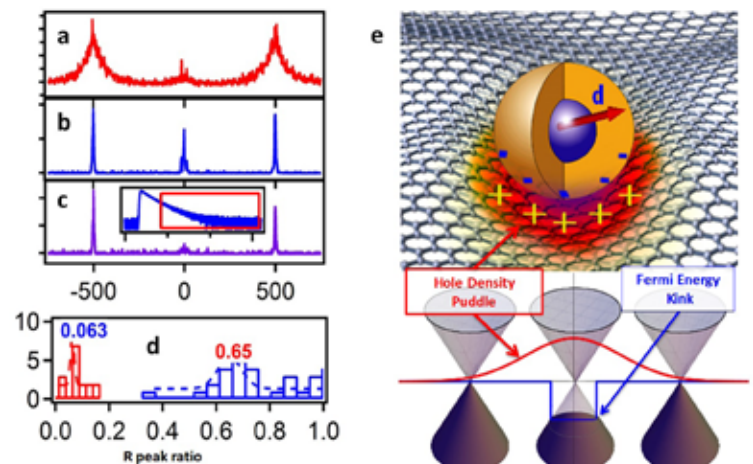

Figure 4. *g* traces of a *g*-NQD on glass (a) and on graphene (b). (c) *g* trace of (b) reconstructed for emission of single excitons that arrive in longer time delay as indicated in the inset. (d) Distribution of bi-exciton emission efficiencies of *g*-NQDs on glass (red) and *g*-NQDs on graphene (blue) showing an order of magnitude enhancement. (e) Upper panel: Optically charged *g*-NQD sitting on top of a graphene sheet where the excess hole density, i.e., *h*-puddle, (red) is induced. The *g*-NQD transition dipole, *d*, interacts with the plasmon mode of the *h*-puddle, resulting in the enhanced energy transfer and radiative emission. Lower panel: Energy diagram showing Fermi energy kink produced by the *g*-NQD charges and associated excess hole density resulting in the hole-puddle.

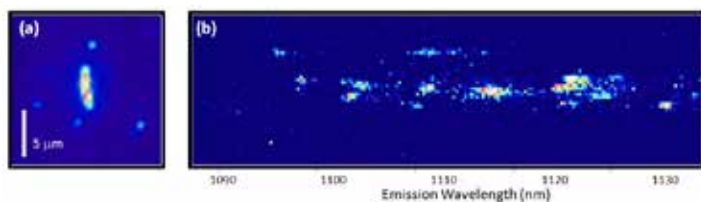

Figure 5. (a) PL image of a SWCNTs encapsulated in SiO₂ matrix. (b) Spectrally dispersed PL image of (a) showing deep trap emission peaks distributed in 1087 - 1140 nm wavelength range. These emission peaks are red-shifted by ~130 meV from the 980 nm PL peak of the SWCNTs before SiO₂ encapsulation.

References

- Shimizu, K. T., W. K. Woo, B. R. Fisher, H. J. Eisler, and M. G. Bawendi. Surface-Enhanced Emission from Single Semiconductor Nanocrystals. 2002. *Physical Review Letters*. 89: 17401.
- Vasa, P., R. Pomraenke, S. Schwieger, Y. I. Mazur, V. Kunets, and P. Srinivasan. Coherent Exciton-Surface-Plasmon-Polariton Interaction in Hybrid Metal-Semiconductor Nanostructures. 2008. *Physical Review Letters*. 101: 116801.
- Hong, G. S., S. M. Tabakman, and K. Welsher. Metal-Enhanced Fluorescence of Carbon Nanotubes. 2010. *Journal of the American Chemical Society*. 132: 15920.
- Sakashita, T., Y. Miyauchi, K. Matsuda, and Y. Kanehitsu. Plasmon-assisted photoluminescence enhancement of single-walled carbon nanotubes on metal surfaces. 2010. *Applied Physics Letters*. 97: 3467834.
- Htoon, H., M. J. O'Connell, P. J. Cox, S. K. Doorn, and V. I. Klimov. Low Temperature Emission Spectra of Individual Single-Walled Carbon Nanotubes: Multiplicity of Subspecies within Single-Species Nanotube Ensembles. 2004. *Physical Review Letters*. 93: 027401.
- Matsuda, K., T. Inoue, Y. Murakami, S. Maruyama, and Y. Kanehitsu. Exciton Fine Structure in a Single Carbon Nanotube Revealed Through Spectral Diffusion. 2008. *Physical Review B*. 77: 193405.
- Empedocles, S. A., and M. G. Bawendi. Quantum-Confinement Stark Effect in Single CdSe Nanocrystallite Quantum Dots. 1997. *Science*. 278: 2114.
- Mueller, J., J. M. Lupton, A. L. Rogen, J. Feldmann, D. V. Talapin, and H. Weller. Monitoring Surface Charge Movement in Single Elongated Semiconductor Nanocrystals. 2004. *Physical Review Letters*. 93: 167402.
- Hoegele, A., C. Galland, M. Winger, and A. Imamoglu. Photon antibunching in the photoluminescence spectra of a single carbon nanotube. 2008. *Physical Review Letters*. 100: 217401.
- Walden-Newman, W., I. Sarpkaya, and S. Strauf. Quantum light signatures and nanosecond spectral diffusion from cavity-embedded carbon nanotubes. 2012. *Nano Letters*. 12: 1934.
- Hofmann, M. S., J. T. Glueckert, J. Noe, C. Bourjau, R. Dehmel, and A. Hoegele. Bright, long-lived and coherent excitons in carbon nanotube quantum dots. 2013. *Nano Letters*. 8: 502.
- Chen, J., M. Badioli, and P. Alonso-Gonzalez. Optical nano-imaging of gate-tunable graphene plasmons. 2012. *Nature*. 487: 77.
- Fei, Z., A. S. Rodin, and G. O. Andreev. Gate-tuning of graphene plasmons revealed by infrared nano-imaging. 2012. *Nature*. 487: 82.
- Chen, Y., J. Vela, and H. Htoon. "Giant" multishell CdSe nanocrystal quantum dots with suppressed blinking. 2008. *JOURNAL OF THE AMERICAN CHEMICAL SOCIETY*. 130: 5026.
- Park, Y. S., A. V. Malko, and J. Vela. Near-Unity Quantum Yields of Biexciton Emission from CdSe/CdS Nanocrystals Measured Using Single-Particle Spectroscopy. 2011. *PHYSICAL REVIEW LETTERS*. 106: 187401.

Publications

Cherqui, C.. Plasmon assisted polaron effects in carbon nanotubes. Student Award Presentation . Invited presentation at TSRC Workshop on Nanomaterials: Theory and Computation. (Telluride, July 16-20, 2012).

Cherqui, C.. The effect of dynamical image force on transport properties of charge carriers and excitons in metal-semiconductor nanostructures. 2014. Ph. D Thesis, Department of Physics, University of New Mexico, Albuquerque.

- Cherqui, C., A. Piryatinski, and D. Dunlap. Surface-plasmon induced quantum corrections to image force. 2014. Under preparation.
- Cherqui, C., D. H. Dunlap, and A. Piryatinski. Diffusion of Plasmon-Exciton Polaron. Presented at APS March Meeting. (Boston, Feb 27- March 2, 2012).
- Crochet, J. J.. Exciton transport and manipulation in colloidal semiconducting carbon nanotubes. Invited presentation at 5th Workshop on Nanotube Optics and Nanospectroscopy. (Santa Fe, 16-20 June, 2013).
- Doorn, S. K.. Surface Chemistry of Carbon Nanotubes: Photoluminescence Probes at the Ensemble, Single-Tube, and Single-Site Levels. Invited presentation at Telluride Science Research Center Workshop on The Chemistry and Physics of Defects in Carbon Nanotubes. (Telluride, CO, 8-12 July, 2013).
- Doorn, S. K.. Exciton transport and manipulation in colloidal semiconducting carbon nanotubes. Invited presentation at 223rd Electrochemical Society Meeting. (Toronto, Canada, 12-16 May, 2013).
- Doorn, S. K.. Surface chemistry of carbon nanotubes: Enabling novel composite materials and studies of dopant chemistry at the 1-D interface. Invited presentation at Lehigh University, Physics Colloquium. (Lehigh University, 3 Oct, 2013).
- Doorn, S. K.. Photoluminescence imaging and spectroscopic studies of low-level covalent doping in carbon nanotubes. Invited presentation at 7th Conference on Excited State Processes in Electronic and Bio Nanomaterials. (Santa Fe, June, 2014).
- Doorn, S. K.. Excitonic fine structure in oxygen doped carbon nanotubes. Invited presentation at 225th Electrochemical Society Meeting. (Orlando, May, 2014).
- Doorn, S. K.. Photoluminescence probes of the 1-D surface environment of carbon nanotubes. Invited presentation at BEST Seminar Series, School of Engineering, UC-Merced. (Merced, CA, May, 2014).
- Doorn, S. K.. Photoluminescence probes of the 1-D surface environment of carbon nanotubes. Invited presentation at Seminar, NREL. (Golden, Co, March, 2014).
- Gao, Y., E. Dervishi, N. Karan, Y. Ghosh, J. Hollingsworth, S. K. Doorn, and H. Htoon. Exploring the charge/energy transfer process at the graphene/giant nanocrystal quantum dots interfaces. Presented at American Physical Society, March Meeting. (Denver, Co, March, 2014).
- Gao, Y., O. Roslyak, E. Dervishi, N. S. Karan, Y. Ghosh, C. J. Sheehan, F. Wang, G. Gupta, A. Mohite, A. M. Dattelbaum, S. K. Doorn, J. A. Hollingsworth, A. Piryatinski, and H. Htoon. Hybrid graphene–giant nanocrystal quantum dot assemblies with highly efficient biexciton emission. 2014. *Advanced Optical Materials*. : 10.1002/adom.201400362.
- Htoon, H.. Influences of exciton diffusion and exciton-exciton annihilation on photon emission statistics of carbon nanotubes. Invited presentation at 7th Conference on Excited State Processes in Electronic and Bio Nanomaterials. (Santa Fe, NM, June, 2014).
- Ma, X., J. G. Duque, J. J. Crochet, S. K. Doorn, and H. Htoon. Photon Statistics of Single Carbon Nanotubes at Room Temperature. 2013. In *American Physical Society, March Meeting*, . (Baltimore, MD, 18-22 March, 2013). Vol. 58, p. 1. Baltimore, MD: American Physical Society.
- Ma, X., J. G. Duque, J. J. Crochet, S. K. Doorn, and H. Htoon. Influences of exciton diffusion and exciton-exciton annihilation on photon emission statistics of carbon nanotubes. Presented at 5th Workshop on Nanotube Optics and Nanospectroscopy. (Santa Fe, June 16-20).
- Ma, X., J. G. Duque, X. Pang, A. Piryatinski, J. J. Crochet, S. K. Doorn, and H. Htoon. Influences of exciton diffusion and exciton-exciton annihilation on photon emission statistics of carbon nanotubes. Presented at MRS Spring Meeting. (San Francisco, CA, April, 2014).
- Ma, X., J. G. Duque, X. Pang, A. Piryatinski, O. Roslyak, D. Dunlap, J. J. Crochet, S. K. Doorn, and H. Htoon. Influences of Exciton Diffusion and Exciton-Exciton Annihilation on Photon Emission Statistics of Carbon Nanotubes. To appear in *Physical Review Letters*.
- Ma, X., N. Hartman, S. K. Doorn, and H. Htoon. Creation of ultra stable deep trap state via SiO₂ encapsulation of carbon nanotubes. *Advanced Materials*.
- Ma, X., O. Roslyak, F. Wang, J. G. Duque, A. Piryatinski, S. K. Doorn, and H. Htoon. Influence of exciton dimensionality on spectral diffusion of single-walled carbon nanotubes. 2014. *ACS Nano*. : 10.1021/nn504138m.
- Piryatinski, A.. Localized Surface-Plasmon Effect on Exciton Transport and Radiative Properties in 1D Nanostructures. Invited presentation at TSRC Workshop on Nonequilibrium Phenomena, Nonadiabatic Dynamics and Spectroscopy. (Telluride, CO, 21-25 July, 2013).
- Piryatinski, A.. Surface-Plasmon Assisted Charge Carrier and Exciton Transport in 1D Nanostructures. Invited presentation at Seminar, Department of Physics, University of Wyoming. (Laramie, 26 April, 2013).
- Piryatinski, A., C. Chirque, and D. Dunlap. Surface-Plasmon Assisted Charge Carrier and Exciton Transport in 1D Nanostructures. Presented at 5th Workshop on Nanotube Optics and Nanospectroscopy. (Santa Fe, 16-20 June, 2013).

Piryatinski, A.. Surface-Plasmon Assisted Charge Carrier and Exciton Transport in 1D Nanostructures. Presented at TSRC Workshop on Nanomaterials: Theory and Computation . (Telluride, 16-20 July, 2012).

Piryatinski, A.. Diffusion, recombination, and surface-Plasmon enhanced photon emission of excitons in semiconductor carbon nanotubes. Invited presentation at Department of Chemistry Colloquium. (University of Missouri-Columbia, Sept. 2014).

Piryatinski, A.. Effect of localized surface-plasmon mode on exciton transport and radiation emission in carbon nanotubes. Invited presentation at Workshop on Structure, Dynamics & Spectroscopy in Condensed Phases: In honor of Prof. Jim Skinner's 60th Birthday. (University Wisconsin-Madison , May, 2014).

Piryatinski, A.. Surface-plasmon assisted charge carrier and exciton transport in 1D nanostructures. Invited presentation at TSRC Workshop on Spontaneous & Collective Coherence. (Telluride, CO, July, 2013).

Piryatinski, A.. Surface-plasmon assisted charge carrier and exciton transport in 1D nanostructures. Invited presentation at The Excitonics Center Seminar at MIT. (Cambridge, MA, Feb, 2013).

Roslyak, O.. Surface-plasmon assisted exciton transport in carbon nanotubes. Invited presentation at Colloquium at Department of Physics . (Fordham University, NY, Feb, 2014).

Roslyak, O., C. Cherqui, D. Dunlap, and A. Piryatinski. Theory of surface-plasmon and exciton emission from carbon nanotube interaction with metal nanoparticle. 2014. Under preparation.

Roslyak, O., C. Cherqui, D. H. Dunlap, and A. Piryatinski. Effect of localized surface-plasmon mode on exciton transport and radiation emission in carbon nanotubes. 2014. The Journal of Physical Chemistry B. 118 (28): 8070.

Wang, F., Q. H. Wei, and H. Htoon. Generation of steep phase anisotropy with zero-backscattering by arrays of coupled dielectric nano-resonators. 2014. Applied Physics Letters. 105 (12): 4896631.

Nonequilibrium Spin Noise in Semiconductors: Physics and Applications

Nikolai Sinitsyn
20120340ER

Abstract

We develop a novel approach for probing material characteristics and new functionalities in technologically important semiconductors. The novelty of our approach is in the observation that a recently developed spin noise spectroscopy technique can probe essentially new physical phenomena in the non-equilibrium regime. To study this regime we developed the theory that interprets our observations of out-of-equilibrium electron spin noise in semiconductors. During our research, we discovered several effects. Each effect revealed physics that is either difficult or impossible to study with other competing techniques. These effects will open up the path for further applications, including high precision measurements of a spin-orbit coupling, obtaining properties of an electron liquid near the metal-insulator transition, characterizing electron transport at extreme conditions of electric breakdown, discovering new types of quantum phase transitions, measuring entanglement entropy and many other effects of importance for the future of several fields. Thus, we developed a completely alternative methodology for characterizing technologically important materials and for applications of these materials under extreme conditions.

Background and Research Objectives

Progress in quantum and material sciences has been enabled by ever increasing sensitivity of measurement technologies. Structure of materials or electron densities can be already routinely probed with atomic resolution. Still, existing techniques do not resolve many vital and fundamental problems, such as the origin of high temperature superconductivity. It seems that the problem is not only in the resolution of measurement devices but also in the restrictions on physical properties that we can measure directly. Modern theoretical physics operates with such concepts as entanglement entropy and exotic quasiparticles but our ability to probe them in materials remains limited.

From the viewpoints of both fundamental measurement and basic science, recently demonstrated spin noise spectroscopy in semiconductors and atomic gases represents a truly landmark achievement. It provided a viable route to study electron spin dynamics at mesoscopic scale, possibly at single spin level by directly measuring local spin-spin correlators of atoms or electrons. By advancing this technique to nonequilibrium domain we are looking at material properties that simply cannot be probed directly by any other approach. Hence, the main goal of this project is to develop a novel approach for spin noise spectroscopy and test it in spin systems. To achieve this goal, we

Developed the quantum statistical theory, supported by experiment, of spin noise in nonequilibrium regime, and explored information that this noise brings about new types of quantum phase transitions, and electron liquids near the metal-insulator transition.

Uncovered and demonstrated new phenomena and developed their applications for high precision measurements of solid-state qubit dynamics and probing many-body effects in interacting spin systems.

Scientific Approach and Accomplishments

The spin noise spectroscopy is a completely novel alternative and a “passive” route, developed at LANL, towards obtaining dynamical information about electrons in semiconductors by measuring spin fluctuations. In spin systems, fundamental noise exists in the form of random spin fluctuations. For example, statistical fluctuations of N paramagnetic spins should generate “spin noise” of order \sqrt{N} , even in a zero magnetic field. Correlations in those fluctuations carry most fundamental information about electron dynamics/interactions because electron spin fluctuations correlate with practically all other microscopic dynamical processes. We explore those fluctuations by purely optical means to obtain information about interacting spin systems. During the

course of this project, our team has achieved all stated goals, as well as produced a number of important results of interest to quantum information and materials science. Specifically:

Throughout the first year of the project we explored the spin noise power spectra of semiconductor quantum dot qubits. Results revealed completely unexpected mechanism of decoherence and relaxation of quantum bits. Previous studies of qubit decoherence by nuclear spin bath did not notice an important type of nuclear spin interactions called quadrupole coupling. Our studies unambiguously showed that the latter is, in fact, one of the major players in decoherence phenomena. This finding is highly important for the future of quantum information technology.

Major theoretical progress had been achieved during the second year (2013). We published a number of articles on developing and applying calculation techniques that characterize spin fluctuations. Theory of spin noise in non-equilibrium regime and in the regime of a strong coupling to detector, as well as the theory of higher order correlators in spin noise spectroscopy had been developed. We proposed extensions of the spin noise spectroscopy setup: the, so-called, two-beam spectroscopy and the hybrid spectroscopy that combines information from measurements of electric voltage and spin fluctuations.

The last year (2014), we have focused on experimental verification of theoretical predictions. Our experimental team has demonstrated the possibility of measuring spin noise at nonequilibrium regime. Results clearly showed that considerable new information about a complex quantum ground state of a spin system was obtained. Another important development was the demonstration of the so-called two-color spin noise spectroscopy, which setup is shown in Figure 1. In two publications, we demonstrated that such a setup provides a unique tool for measurements of spectral linewidths in linear response regime and to characterize cross-correlations in heterogeneous spin systems. Our results open new prospects on studies of ultracold gases and improving sensitivity of atomic magnetometers. We also predicted theoretically the possibility to observe spin noise in a novel class of materials called Dirac semiconductors. Unlike conventional semiconductors, we predicted a number of new features that will help to develop an emerging field called opto-valleytronics.

The high quality of our research results is witnessed by our publications, which include 6 articles in Physical Review Letters and one in Nature Communications – the highest rank and most competitive journals in the field of condensed matter physics.

Impact on National Missions

This project has built Laboratory capabilities in the development of novel measurement methods that enable new scientific discovery. Our project is enabled by recent technological advancements that use very large data storage and manipulation capabilities. Until very recently this technology, which is absolutely necessary for the experimental work herein, simply did not exist. Our results also depend on recent scientific discoveries in the field of spin noise spectroscopy and include a theoretical underpinning with computation and modeling support. They will advance new Laboratory capabilities that underpin a wide variety of missions including Nanotechnology and Quantum Information Science. This project attracted worldwide attention, which is evident from the high citation rates of our publications. Despite the fact that numerous groups in Europe, Russia, Japan and China have joined research on spin noise spectroscopy, our team continued to demonstrate leadership in this field, while being the only group in U.S. working in this field. We are going to use this unique capability to form a robust platform for a mesoscale spintronics program at LANL. The present project will lay the groundwork for future research to address national problems, including new functional materials capabilities for MaRIE and energy efficient applications (DOE, DARPA).

Figure 1. First demonstration of two-color spin noise spectroscopy

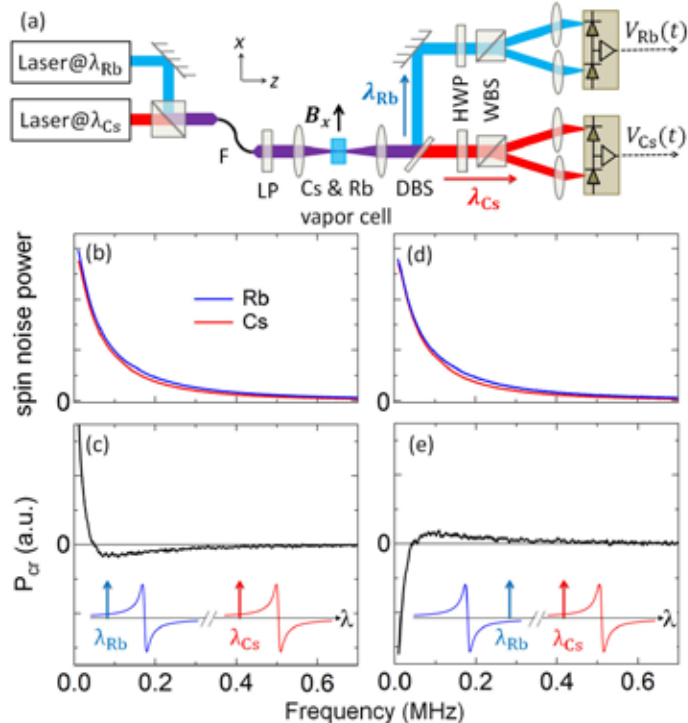

copy for measurements of spin cross-correlations. (a) Setup in which mixture of two laser beams (red and blue) is used to detect cross correlations between spins of Cs and Rb atoms. (b-c) and (d,e): noise power and cross correlation spectra for different frequencies of the measurement beams.

References

1. Tse, W. K., A. Saxena, D. L. Smith, and N. A. Sinitsyn. Spin and valley noise in two-dimensional dirac materials. 2014. *Physical Review Letters*. 113: 046602.
2. Slipko, V. A., N. A. Sinitsyn, and Y. V. Pershin . Hybrid spin noise spectroscopy and the spin Hall effect. 2013. *Physical Review B*. 88: 201102(R).
3. Li, F., J. Ren, and N. A. sinitsyn. Quantum Zeno effect as a topological phase transition in full counting statistics and spin noise spectroscopy. 2014. *Euro Physics Letters*. 105: 27001.
4. Glasenapp, P., L. Yang, D. Roy, D. G. Rickel, I, A. Greilich, M. Bayer, N. A. Sinitsyn, and S. A. Crooker. Spin noise spectroscopy beyond thermal equilibrium and linear response. To appear in *Physical Review Letters*.
5. Roy, D., L. Yang, S. A. Crooker, and N. A. Sinitsyn. Cross-correlation spin noise spectroscopy of heterogeneous interacting spin systems. *Physical Review Applied*.
6. Yang, L., P. Glasenapp, A. Greilich, D. R. Yakovlev, M. Bayer, and S. A. Crooker. Two-color spin noise spectroscopy: Using spin fluctuation correlations to reveal homogeneous linewidths within quantum dot ensembles. 2014. *Nature Communications*. 5: 4949.
- Li, F., Yuriy V. Pershin, Valeriy A. Slipko, and N. A. Sinitsyn. Nonequilibrium spin noise spectroscopy. 2013. *Physical Review Letters*. 111: 067201.
- Li, Y., N. A. Sinitsyn, D. Smith, D. Reuter, A. Wieck, D. Yakovlev, M. Bayer, and S. Crooker. Intrinsic spin fluctuations reveal the dynamical response function of holes coupled to nuclear spin baths in (In,Ga)As quantum dots. 2012. *Physical Review Letters*. 108: 186603 .
- Pershin, Y. V., V. A. Slipko, D. Roy, and N. A. Sinitsyn. Two-beam spin noise spectroscopy. 2013. *Applied Physics Letters* . 102: 202405.
- Roy, D., L. Yang, S. A. Crooker, and N. A. Sinitsyn. Cross-correlation spin noise spectroscopy of heterogeneous interacting spin systems. *Physical Review Applied* .
- Roy, D., Y. Li, A. Greilich, Y. V. Pershin, A. Saxena, and N. A. Sinitsyn. Spin noise spectroscopy of quantum dot molecules. 2013. *Physical Review B*. 88: 045320.
- Sinitsyn, N. A., Y. Li, S. A. Crooker, A. Saxena, and D. L. Smith. Role of Nuclear Quadrupole Coupling on Decoherence and Relaxation of Central Spins in Quantum Dots. 2012. *Physical Review Letters*. 109: 166605 .
- Slipko, V. A., N. A. Sinitsyn, and Y. Pershin. Hybrid spin noise spectroscopy and the spin Hall effect. 2013. *Physical Review B*. 88: 201102(R).
- Sykes, A., D. Solenov, and D. Mozyrsky. Bloch-Redfield theory of high-temperature magnetic fluctuations in interacting spin systems. 2012. *Physical Review B*. 85: 174419.
- Tse, W., A. Saxena, D. Smith, and N. A. Sinitsyn. Spin and Valley Noise in Two-Dimensional Dirac Materials. 2014. *Physical Review Letters*. 113: 046602.
- Yang, L., P. Glasenapp, A. Greilich, D. Reuter, A. D. Wieck, D. R. Yakovlev, M. Bayer, and S. A. Crooker. Two-colour spin noise spectroscopy and fluctuation correlations reveal homogeneous linewidths within quantum-dot ensembles. 2014. *Nature Communications*. 5: 4949.
- Zapasskii, V. S., A. Greilich, S. A. Crooker, Y. Li, G. G. Kozlov, D. R. Yakovlev, D. Reuter, A. D. Wieck, and M. Bayer. Optical Spectroscopy of Spin Noise. 2013. *Physical Review Letters*. 110: 176601.
- Ganeshan, S., and N. A. Sinitsyn. Fluctuation Relations for Current Components in Mesoscopic Electric Circuits. 2011. *Physical Review B*. 84: 245405.
- Glasenapp, P., L. Yang, D. Roy, D. G. Rickel, A. Greilich, M. Bayer, N. A. Sinitsyn, and S. Crooker. Spin noise spectroscopy beyond thermal equilibrium and linear response. To appear in *Physical Review Letters*.
- Li, F., A. Saxena, D. L. Smith, and N. A. Sinitsyn. Higher Order Spin Noise Statistics. 2013. *New Journal of Physics*. 15: 113038.
- Li, F., J. Ren, and N. A. Sinitsyn. Quantum Zeno effect as a topological phase transition in full counting statistics and spin noise spectroscopy. 2014. *Euro Physics Letters*. 105: 27001.

Publications

Chaudhury, S., J. Cao, and N. A. Sinitsyn. Universality of Poisson Indicator and Fano Factor of Transport Event Statistics in Ion Channels and Enzyme Kinetics. 2013. *Journal of Physical Chemistry B* . 117: 503.

Chernyak, V. Y., J. Klein, and N. A. Sinitsyn. Algebraic topology and the quantization of fluctuating currents. 2013. *Advances in Mathematics*. 244: 791.

Ganeshan, S., and N. A. Sinitsyn. Fluctuation Relations for Current Components in Mesoscopic Electric Circuits. 2011. *Physical Review B*. 84: 245405.

Glasenapp, P., L. Yang, D. Roy, D. G. Rickel, A. Greilich, M. Bayer, N. A. Sinitsyn, and S. Crooker. Spin noise spectroscopy beyond thermal equilibrium and linear response. To appear in *Physical Review Letters*.

Li, F., A. Saxena, D. L. Smith, and N. A. Sinitsyn. Higher Order Spin Noise Statistics. 2013. *New Journal of Physics*. 15: 113038.

Li, F., J. Ren, and N. A. Sinitsyn. Quantum Zeno effect as a topological phase transition in full counting statistics and spin noise spectroscopy. 2014. *Euro Physics Letters*. 105: 27001.

Novel Inverted Nanoshells for Multimodal Diagnostic Imaging and Cancer Therapy

Jennifer A. Hollingsworth
20120365ER

Abstract

The overarching goal is to design and implement a new nanoparticle-based platform for imaging and diagnostics combined with cancer therapy. The approach is to encapsulate within a metal shell a semiconductor quantum dot that affords reliable photoluminescence for optical imaging, with the possibility to also include within the metal shell magnetic resonance contrast agents for multimodal imaging. The metal shell serves multiple purposes: protecting/enhancing quantum dot fluorescence, generating lethal doses of heat upon infrared irradiation (photothermal cancer therapy), and presenting a biocompatible surface that is easy-to-functionalize for specific cancer-cell targeting. In contrast with other nanoparticle-based approaches that aim to couple diagnostics with therapy, this approach affords greater simplicity, smaller/tunable particle sizes, enhanced optical performance, biocompatibility and an internal “thermometer.” Our design strategy is guided by theoretical-modeling studies, which revealed the transformative potential of “inverted nanoshell” (INS) structures to enhance the optical properties (absorption and/or emission) of emitters positioned inside a metal shell. The inverted geometry—compared to conventional “nanoshell” architectures that incorporate emitters on the outside of a metal shell—promises optical-intensity enhancement that is both strong and uniform. In contrast, the field enhancement outside a metal-shell structure, though very large at the surface of the metal, drops off quickly and non-uniformly with distance from the metal. Here, we attempt to take advantage of the internal field enhancements by placing our fluorophores on the inside of a metal nanoshell, advancing the state-of-the-art in fluorophore probe design, while at the same time combining this concept with a therapy functionality – hyperthermal cancer-cell ablation. We demonstrate proof-of-concept deep-tissue imaging and selective photothermal therapy using peptide- or antibody-INS conjugates.

Background and Research Objectives

Invasive forms of cancer (e.g., lung, breast, colorectal) remain the leading cause of death in the developed world. Despite a >\$200 billion investment in cancer research in the U.S. since 1971, cancer death rates in this country have dropped by only 5% (1950-2005). Traditional “cancer management” typically entails combinations of different forms of treatment, such as chemotherapy, radiation therapy and surgery. The former two suffer from a tendency to damage healthy tissue at the same time that they are being used to treat cancerous tissue, while surgery can miss cancer that has metastasized to other regions of the body. It is becoming increasingly evident that a more ideal cancer treatment would be both more selective (targeted) and comprehensive.

To this end, alternatives to traditional small-molecule, cytotoxic drugs are being pursued that would allow the therapeutic agent to be delivered more specifically to the offending cancer cells. Although some examples of targeted small-molecule drugs exist (e.g., tyrosine kinase inhibitors), chemotherapy agents are generally not capable of being specifically targeted to cancer cells. An important, newer approach is to utilize nanoparticles as vehicles both for a therapeutic agent and for targeting molecules that ensure delivery to the correct cells. The interior of the nanoparticle can be used to carry the toxic payload (e.g., cytotoxic drug) and the surface of the nanoparticle to present targeting ligands. The most common approaches utilize polymer or porous glass nanoparticles and can be either simple structures relying on natural, slow release of the drug as the particle breaks down in the body, or complex nanomachines expected to provide “on-demand” drug release as a function of controlled stimuli.

Although promising for the reasons stated, the medical professional is still typically “flying blind.” That is, the above constructs do not generally afford the ability to confirm that the nanoparticle has indeed reached its

intended target. Such nanoparticle-based delivery agents that offer a therapy but do not provide a secondary means for confirming accurate targeting and anti-tumorigenic activity are not optimal. Our proposed approach addressed this important deficiency.

The overarching goal was to design and implement a new nanoparticle-based platform for combined multimodal imaging and cancer therapy. To achieve this, we proposed to encapsulate within a metal shell a semiconductor quantum dot (QD) core that affords efficient and stable photoluminescence (PL: light emitted when the QD is stimulated by a light emitting diode, LED, or a laser). Ideally, the metal shell would serve a dual purpose – simultaneously enhancing QD PL (by way of so-called “Purcell enhancement” effects: see Approach) and generating heat upon exposure to infrared irradiation, where the latter would provide a form of “photothermal cancer therapy,” i.e., killing cancer cells through heat. Although other nanoparticle-based approaches have aimed to couple diagnostics with therapy, our approach afforded key distinguishing features.

We distinguished our effort from prominent literature work as follows. First, the most successful literature approaches have used a “nanoshell” architecture that comprises a gold-coated silica sphere, where the gold shell can be heated-up using an infrared or radiofrequency excitation source, and for imaging purposes, fluorescent dye molecules (for optical detection) or iron oxide nanoparticles (for magnetic resonance contrast) can be encapsulated in a silica layer overcoating the gold shell [1] [2]. In contrast, our aim was to create an “inverted nanoshell” architecture that places a fluorescent QD on the inside of a gold shell, with a silica spacer layer separating the two. Compared to nanoshells, inverted nanoshells, or INS particles, are small: 10-100 versus ~200 nm. Significantly, nanoparticles within the 10-100 nm size range are predicted to afford both optimal penetration into and movement within disseminated tumors, while at the same time allowing for sufficient circulation time followed by access to the liver, minimizing toxicity. The proposed INS approach would allow a high level of functionality in perfectly sized 40-50 nm particles. Second, the INS particles are simpler (imaging components all “packaged” within the interior) and inherently biocompatible due to the outer-surface comprising only non-toxic gold, where gold also affords easy chemical functionalization, e.g., using well-known thiol coordination chemistry. Third, the INS design can afford unique physics, where the gold shell creates a highly uniform and strong plasmonic field inside the sphere that can enhance QD (or other emitter) PL by enhancing either excitation or emission processes [3]. Lastly, our INS structures would make use of our uniquely stable, non-blinking giant-QDs (g-QDs)

to ensure that the QD emitter remains bright and robust after encapsulation within the gold shell, in contrast with a previous literature report that utilized inferior QDs and a non-optimized spacer layer between the QD and the gold shell, succeeding only in significantly quenching QD PL [4].

Research Objectives

- Synthesize, characterize, optimize novel functional INS particles: Synthetic chemistry for INS fabrication was established and validated using optical characterization, structural characterization and theoretical modeling. The effects of space-layer and gold-shell thicknesses on key QD optical and gold-shell plasmonic properties were assessed using ensemble and single-particle-level optical spectroscopy and microscopy.
- Assess optimized INS particles for deep-tissue imaging. Use matrigel as artificial “tissue-like” scaffold to determine/demonstrate depth-dependent simultaneous heating and imaging. Note: this objective modified from original as we discovered that the g-QD emitter could also serve as an internal “thermometer” (see Accomplishments).
- Establish proof-of-concept cancer-cell targeting and photothermal therapy. INS-peptide and INS-antibody conjugates were synthesized, and the latter was successfully targeted to breast cancer cells. Non-specific binding was also employed to uptake INS particles in the case of cervical cancer cells. Both systems were subjected to infrared irradiation and assessed for cell death efficacy.

Scientific Approach and Accomplishments

Our overall approach follows the three Research Objectives described above. Here, we describe our significant accomplishments resulting from undertaking these objectives toward the goal of realizing novel INS particles for simultaneous imaging and photothermal cancer therapy. Along the way, underpinning synthetic chemistry and photophysical understanding were established, and initially unanticipated observations and results were achieved.

Objective 1

Bright silica-coated dots as enabling technology for controlling plasmonic interactions: The INS architecture comprises a core g-QD, a thin polyelectrolyte spacer layer, a thick silica spacer layer, a gold shell, and a surface functionalization (Figure 1). Significantly, as discussed below, the gQD optical properties were largely retained in the INS structure. Further, during the course of this study we observed that by tuning the silica layer we could tune the interactions between the gQD and plasmonic structures other than the synthesized gold shell. Specifically, we stud-

ied semiconductor-plasmonic interactions in gQD/silica and gold nanoantenna couples [5].

Developed gold-shell chemistry: We quickly established the ability to grow silica shells for a range of silica spacer thicknesses from 10-20 nm, but the gold shell chemistry proved elusive. Initially, for example, we observed that the gold either deposited in an uncontrolled fashion, yielding uneven and thick deposits, or we found by electron microscopy structural characterization that the gold ions were able to penetrate the mesoporous silica shell, sometimes yielding gold droplets at the g-QD/silica interface. The latter resulted in significant quenching of the g-QD PL. Ultimately, this significant challenge was solved by including a second, “soft” spacer layer between the g-QD and the silica that comprised several layers of polyelectrolyte (Figure 1a). That modification, along with thicker silica shells, allowed us to obtain highly luminescent and stable INS particles (Figure 2). Interestingly, the gold shell has been challenging to characterize using transmission electron microscopy, as the thin shell appears to react in the electron beam, rapidly breaking apart into small islands. That said, we have been able to obtain high-resolution images proving the completeness of the gold shell (Figure 1b-c). In addition, we have used optical absorption spectroscopy to confirm that the shell affords the expected plasmonic resonance feature, with the energy of the feature dependent on both the “core” (g-QD/silica) size and the gold-shell thickness (Figure 3).

Objective 2

Studies using matrigel as an artificial human tissue-like scaffold for studies of nanoparticles at depth. We initially evaluated the penetration efficiency of our g-QDs as INS surrogates (i.e., prior to our establishing a successful INS synthesis protocol, which has now been achieved) through decreasing concentrations of matrigel (9.5 - 3 ng/mL), finding lower concentrations (3 - 5 ng/mL) to be more favorable for g-QD penetration. 3T3 cells were grown in the optimal matrigel suspension, and g-QDs evaluated for penetration-efficiency and non-specific binding/ phagocytosis by cells. Further, the g-QDs (again, as INS surrogates) were evaluated for baseline cytotoxicity and found to be non-cytotoxic in the relevant concentration ranges, a positive indicator that unintended particle-related toxicity would not interfere with intentional irradiation-induced thermal toxicity.

While these initial results obtained for g-QDs were promising, the matrigel tissue surrogates were not the focus of studies once the INS particles were successfully synthesized and ready for analysis. Rather, we have focused on Objective 3 goals, i.e., on establishing specific cancer-cell targeting and ablation (see below). That said, we have

further used the matrigel matrix to determine/demonstrate depth-dependent simultaneous heating and imaging. In this experiment, INS is placed at different depths in the matrigel. The INS are irradiated with blue and infrared laser sources, where the blue source causes the g-QDs within the INS to emit red light that is imaged and spectrally analyzed. The infrared source causes the gold shell to heat up. Monitoring the decrease in g-QD emission intensity quantitatively assesses the heating. The PL intensity decline is calibrated against intensity versus temperature plots obtained by us previously for water-solubilized g-QDs. In this way, the g-QD emitters acts as a thermometer for the local temperature generated by the infrared-stimulated gold shell heating. Note: the discovery that the g-QD could be used to determine the local INS heating caused us to modify this objective to emphasize demonstration of truly simultaneous imaging and quantified heating.

Objective 3

Live-cell single-particle-tracking studies using bright/stable dots benefitting from bioconjugation strategies: Single-particle-tracking (SPT) of receptors in live cells using conventional QDs as optical probes has been limited by the intermittency of the QD's emission signal that results from “blinking,” as well as by motion of the receptor out of the imaging plane of the microscope. We overcame these limitations by integrating our non-blinking g-QDs for confocal-based three-dimensional live cell SPT of the IgE-FcεRI allergen receptor (featured in *Advanced Functional Materials* as a “Frontispiece” article) [6]. We showed that this approach affords extended tracking duration—a 7-fold increase in the probability of observing IgE-FcεRI for longer than 1 minute—compared to conventional core/shell QDs that blink, leading to observations of heterogeneous receptor diffusion occurring over time scales of minutes.

The success of this effort depended upon successful bioconjugation strategies for effecting selective binding of our nanoparticles to targeted cells. Specifically, the nanoparticles were terminated with carboxyl end groups (g-QDs intentionally functionalized with linker molecules containing thiol ends to bind to the nanoparticle and carboxyl ends to bind to the cell-targeting agent) that were used to facilitate the required coupling chemistry to a Neutravidin, which then allowed strong binding to a biotinylated IgE (note: avidin-biotin binding is very strong and commonly used in bioconjugation protocol). Cell targeting specificity (targeted-to-untargeted ratio) was optimized and subsequently demonstrated in the successful single-particle tracking study. The chemistry established for the simple g-QD nanoparticles was then translated to the INS particles for peptide bioconjugation in an attempt to target HER2-expressing human breast cancer cells.

Successful photothermal experiments in water: Before any live-cell experiments were conducted, we demonstrated the potential for INS-based photothermal therapy and simultaneous imaging in simple aqueous solutions. We showed that under infrared irradiation, INS nanoparticles caused water to heat up in a dramatic fashion, while g-QD/silica particles did not heat water and produced the same level of heating as water without any nanoparticles present (Figure 4). In addition, we demonstrated that the INS' g-QD photoluminescence could be monitored during heating and that heat-induced g-QD quenching (assessed using a previously generated calibration curve, Figure 4c) could be used to determine the "local" temperature of the INS particle, which was significantly higher than the surrounding water (Figure 4b).

Successful breast cancer cell targeting and preliminary cell ablation: Ultimately, the above bioconjugation strategy applied to INS proved less successful for the larger particles and was replaced with a simpler approach – antibody targeting agent terminated with a thiol group for direct binding to the INS gold shell, thereby taking advantage of this feature of the INS structure, i.e., facile bioconjugation using strong and direct thiol-gold interactions. With the INS-antibody conjugates we successfully demonstrated selective binding to breast cancer cells (Figure 5). Further, we have conducted several infrared irradiation experiments. Recently, one of these experiments has shown that the INS particles induce breast cancer cell ablation. Although we were looking for less dramatic cell death induced by oxidative stress following INS heating, we instead observed cell ablation, with cells sloughing off the incubation dish.

In summary, further studies would emphasize controlling the "heating dose," but our initial proof-of-principle studies successfully demonstrate the possible utility of INS for cancer cell therapy. Combined with our assessment of INS as effective optical probes and as local temperature thermometers, the results demonstrate the intended outcome: Multimodal Diagnostic Imaging and Cancer Therapy. A manuscript is in preparation that describes the INS approach as well as the relevant synthetic chemistry, photo-physics, and biological implications [7].

Impact on National Missions

We have established new capabilities in optical nanomaterials synthesis and advanced imaging in complex media, significantly improving our understanding of interactions at the nano-bio interface and providing proof-of-concept for a new approach "theranostics." Basic understanding of materials and basic health research are advanced, with important implications for biosecurity, e.g., countering drug-resistant pathogens. The work has resulted in a new

optical nanomaterial with potential applications in efficient lighting, light-based communications technologies, low-threshold lasing, single-photon sources for quantum cryptography, as the INS structure solves key flaws of more conventional emitters, e.g., making g-QDs into "fast" emitters while retaining their excellent photo/chemical stability (DOE Office of Science existing program). The results are also directly relevant to the needs of DHHS and global security agencies in general, where predicting and controlling nanoparticle mediated activity at the molecular, cellular and tissue levels has implications from nano-enabled bio/chem-sensors to non-invasive treatment of non-cancerous diseased tissue and "battle suit medicine," while the ability to induce heating with light-based triggers and to monitor heating with light-based readout is expected to impact non-biological arenas as well.

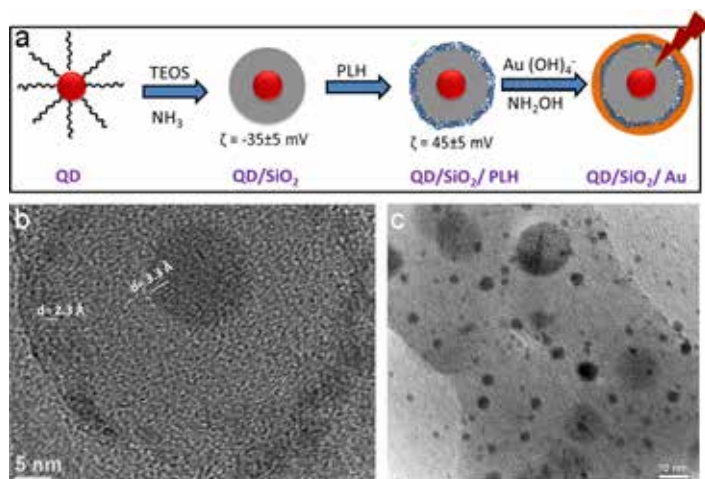

Figure 1. (a) Schematic of the important steps involved during the synthesis of INS particles: Step 1 - silica coating of g-QDs in reverse microemulsion (TEOS is tetraethyl orthosilicate); Step 2 - (PLH) functionalization of the g-QD/SiO₂; Step 3 - Gold (in 3 oxidation state) is added then reduced by further addition of NHOH to form gold shell. (b) High-resolution transmission electron microscopy (TEM) image of INS particle revealing lattice spacing for gold shell compared to the g-QD core. (c) Gold nanoparticles that form by rapid electron-beam induced heating and coalescence reveal significant challenges for high-resolution imaging of thin gold shells.

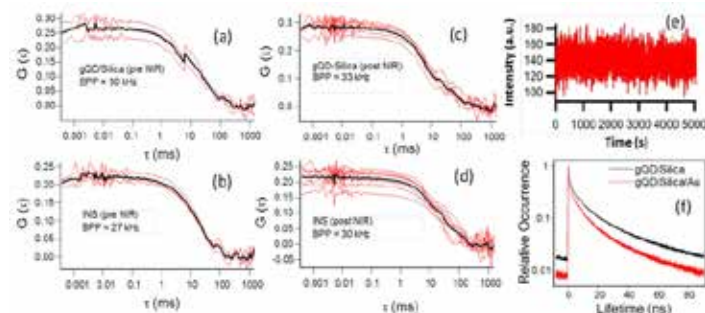

Figure 2. Fluorescence Correlation and Single-particle Spectros-

copy. (a-d) Fluorescence correlation spectroscopy (FCS) measurements of g-QD/silica and INS particles before and after near-infrared irradiation. Results reveal that “brightness per particle” (BPP) is similar for the silica-only and the gold-shell INS particles, indicating that the gold shell does not adversely affect the g-QD optical properties, and further show that infrared-induced heating in the case of the INS particles also does not deleteriously affect INS emission. (e) Representative emission intensity time trace for INS particles synthesized using CdSe/CdS g-QDs. (f) Lifetime plot of g-QD/SiO before and after gold shelling. Average lifetime values are 15 and 8 ns, respectively.

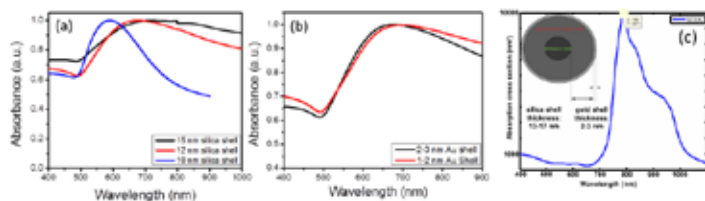

Figure 3. Absorption spectroscopy and modeling showing surface plasmon resonance peak positions for different INS geometries. (a-b) Absorption spectra of INS nanoparticles characterized by different silica shell (a) and Au shell thicknesses (b). (c) Calculated absorption cross section of g-QD/SiO/Au INS. Plasmon response of the Au shell is modified by the core dielectric environment. In the calculations, we sampled a uniform distribution of the SiO and Au shell widths as indicated. As a result the plasmon line shape is inhomogeneously broadened. These calculations provide similar absorption peak position obtained experimentally for similar nanostructures. However, the experimental lineshape receives additional broadening from effects not included in the calculations, e.g., deviation of the nanostructure from spherical shape, environment.

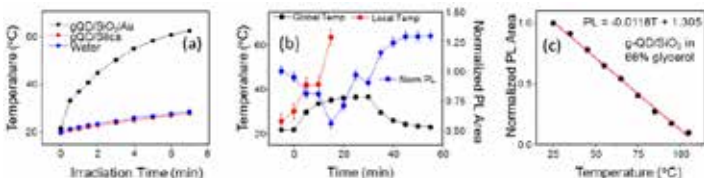

Figure 4. Under infrared irradiation, INS nanoparticles caused water to heat up in a dramatic fashion, while g-QD/silica particles did not heat water and produced the same level of heating as water without any nanoparticles present.

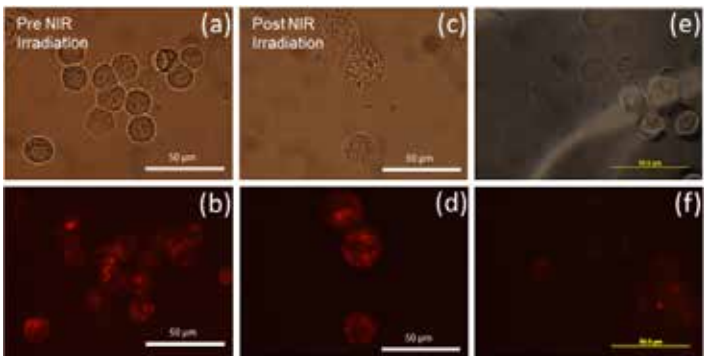

Figure 5. Cancer Cell Targeting and Imaging with INS Nanopar-

ticles. Bright field (top panel) and fluorescence (bottom panel) microscopy images of SKBR3 breast cancer cells. (a-d) Cells were successfully targeted using INS nanoparticles functionalized with anti-Her2 antibody and (e-f) Control: INS nanoparticles functionalized with PEG-SH ligands do not bind significantly to cells; g-QD red PL is faint and diffuse.

References

- Gobin, A. M.. Near-infrared resonant nanoshells for combined optical imaging and photothermal cancer therapy. 2007. Nano Letters. : 1929.
- Bardhan, R.. Tracking of multimodal therapeutic nano-complexes targeting breast cancer in vivo. 2010. Nano Letters. : 4920.
- Miao, X.. Nanocomposite plasmonic fluorescence emitters with core/shell configurations. 2010. Journal of the Optical Society of America B. : 1561.
- Jin, Y., and X. Gao. Plasmonic fluorescent quantum dots. 2009. Nature Nanotechnology. : 571.
- Wang, F.. Correlated structure-photoluminescence properties of giant quantum dot and nanoantenna coupled systems. Advanced Functional Materials (in preparation).
- Keller, A. M.. 3-dimensional tracking of non-blinking ‘giant’ quantum dots in live cells. 2014. Advanced Functional Materials. : 4796–4803.
- Karan, N.. Compact multimodal inverted nanoshells for simultaneous optical imaging and ablation of cancer cells. Nature Communications (in preparation as Article).

Publications

- Hollingsworth, J. A.. Heterostructured Quantum Dots: From Molecular Probes Toward Cancer Therapy. Invited presentation at Nanoparticle Synthesis and Applications Cancer Imaging and Treatment Symposium . (University of New Mexico, Albuquerque, 16 Aug. 2013).
- Hollingsworth, J. A., J. H. Werner, H. Htoon, A. Piryatinski, R. Schaller, Y. Ghosh, A. M. Dennis, A. M. Keller, B. Mangum, and D. C. Hannah. Non-blinking “giant” quantum dots: Ideal probes for real-time three-dimensional tracking. 2013. In CLEO:2013. (San Jose, CA, 9-14 June 2013). Vol. CLEO:QELS Fundamental Sci, p. Biophotonics (QTu1P). OSA Optics InfoBase: The Optical Society.

- Hollingsworth, J. A., J. Werner, R. Iyer, N. Karan, A. Keller, A. Nagy, Y. Ghosh, and J. L. Casson. Novel inverted nanoshells for multimodal diagnostic imaging and cancer therapy. Invited presentation at Los Alamos

National Laboratory Laboratory Directed Research and Development Day. (Santa Fe, October 23, 2012).

Karan, N., A. Keller, C. Hanson, A. Ayesha, B. Piyush, R. Iyer, J. Werner, A. Piryatinski, A. Malko, and J. Hollingsworth. Compact multimodal inverted nanoshells for simultaneous optical imaging and ablation of cancer cells. *Nature Communications* (in preparation as Article).

Keller, A. M., Y. Ghosh, M. E. Phipps, D. S. Lidke, B. S. Wilson, J. A. Hollingsworth, and J. H. Werner. 3-dimensional tracking of blinking-suppressed quantum dots in live cells. 2013. In *Biophysical Society 57th Annual Meeting*. (Philadelphia, February 2-6, 2013). , p. 1. Conference Abstracts: Biophysical Society.

Keller, A. M., Y. Ghosh, M. S. DeVore, M. E. Phipps, M. H. Stewart, D. S. Lidke, B. S. Wilson, J. A. Hollingsworth, and J. H. Werner. 3-Dimensional Tracking of Non-blinking 'Giant' Quantum Dots in Live Cells. 2014. *Advanced Functional Materials*. 24 (30): 4796–4803.

Park, Y. S., Y. Ghosh, P. Xu, N. H. Mack, H. L. Wang, J. A. Hollingsworth, and H. Htoon. Single-nanocrystal photoluminescence spectroscopy studies of plasmon-multiexciton interactions at low temperature. 2013. *The Journal of Physical Chemistry Letters*. 4: 1465.

Wang, F., H. M. Nguyen, N. Karan, J. A. Hollingsworth, and H. Htoon. Correlated structure-photoluminescence properties of giant quantum dot and nanoantenna coupled systems. *Advanced Functional Materials* (in preparation).

Flipping the (light) Switch on Nano-magnetism: Emergent Photomagnetization in Quantum-confined Semiconductors

Scott A. Crooker
20120374ER

Abstract

Manipulation of magnetic metals forms the cornerstone of today's vast information-storage industry. In parallel, semiconductors provide the basis for current microprocessor technologies. It is therefore not surprising that the marriage of magnetism and semiconductors – as typified in today's diluted magnetic semiconductors (DMS) and in complex oxides -- are thriving and active research areas. Whereas ordinary semiconductor devices rely only on the charge of electrons and holes, DMS materials achieve new functionalities by also exploiting the spin of electrons and holes (namely, via spin-exchange or so-called "sp-d" coupling to embedded magnetic atoms such as Mn, Co, or Fe). Generally speaking, the coupling between band electrons and local magnetic moments underpins many fascinating phenomena in condensed matter physics and is responsible for a variety of emergent properties. In diluted magnetic semiconductors, these sp-d couplings can lead, e.g., to giant g-factors, magnetic polarons, and/or carrier-mediated ferromagnetism. As basic research in both magnetism and semiconductors continues its focus on miniaturization, DMS materials are also now pushing the limits of quantum confinement. To address how sp-d interactions are affected – and controlled – by quantum confinement and wavefunction engineering at the nanoscale, advances in molecular-beam epitaxy and colloidal synthesis have focused considerable attention on DMS materials of reduced dimensionality: 2-D quantum wells, 1-D wires, and 0-D epitaxial dots and (even-smaller) colloidal nanocrystals.

Background and Research Objectives

The coupling between band electrons and local magnetic moments underpins many fascinating phenomena in condensed matter physics. In semiconductors, these couplings are simply realized in diluted magnetic semiconductors (DMS), where strong sp-d exchange interactions between electron/hole spins and embedded magnetic atoms (typically Mn or Co) can lead, e.g., to

giant g-factors, magnetic polarons, or carrier-mediated ferromagnetism. To address how sp-d interactions are affected – and controlled – by quantum confinement and wavefunction engineering, advances in molecular-beam epitaxy and colloidal synthesis have focused considerable attention on DMSs of low dimensionality: 2D quantum wells, 1D wires, 0D epitaxial dots and (even-smaller) colloidal nanocrystals. Remarkably, recent studies reveal the influence from even single magnetic atoms, as well as new emergent phenomena such as tunable sp-d coupling and strong photo-induced magnetization. The full scope and importance of these new properties that emerge from nanoscale confinement have only begun to be explored.

Recent work at Los Alamos has demonstrated the synthesis of truly "zero-dimensional" DMS materials in the limit of extreme quantum confinement: these new materials are semiconductor nanocrystals (of, e.g., ZnSe or CdSe) containing small numbers (<5) of magnetic atoms (e.g., Mn or Co). Remarkably, these novel nanoscale materials are beginning to exhibit unexpected and new emergent properties that simply do not (or cannot) exist in their more conventional 3-D or 2-D forms. Demonstrated functionalities include the ability to tune magnetic exchange interactions via quantum confinement and wavefunction engineering at the nanometer scale, magnetic polaron formation at high temperatures, and – especially -- a recently-discovered photo-induced magnetism in a new magnetic semiconductor system based on copper-doped nanocrystals. The full scope and importance of these new photo-magnetic properties that emerge from nanoscale confinement have only begun to be explored. Thus, understanding how light can influence and potentially control magnetism at the nanoscale forms the centerpiece of this proposal.

Our scientific goal is therefore to investigate these new families of nanometer-scale magnetic semiconductors, with an emphasis on wavefunction engineering and

controlled placement of magnetic dopants within core-shell nanocrystals to achieve new functionality. The work will focus on emergent optically-controlled magnetization, tunable spin-exchange interactions, and ultrafast spin dynamics. Cutting-edge colloidal synthesis and the study of ultrafast magnetization dynamics via Time-Resolved Faraday Rotation (a new LANL capability) are the essential components of this work.

Scientific Approach and Accomplishments

The key challenges for realizing and understanding emergent photo-magnetic effects in doped nanocrystals are: i) reliable colloidal synthesis of doped core-shell structures including controlled radial distributions of Mn and Cu atoms, ii) measurement of the essential sp-d (carrier-magnetic ion) exchange interactions and their response to light, and iii) construction and implementation of the new Time-Resolved Faraday Rotation (TRFR) technique for ultrafast spin dynamics. In this project, these points were addressed as follows: i) Our team demonstrated colloidal growth of related core-shell nanocrystals. ii) We now have in place a working spectroscopy based on magnetic circular dichroism (MCD) to directly characterize sp-d couplings in magnetic semiconductors at low temperatures and high magnetic fields; new optics and a spectrometer will be necessary to achieve optimal resolution. iii) We have established a TRFR capability at the NHMFL in Los Alamos, based on an ultrafast Ti:sapphire laser and Optical Parametric Oscillator. TRFR techniques represent a new and general capability here at LANL, one that is widely applicable outside of semiconductor physics – e.g., using TRFR, spin dynamics have been studied in a variety of magnetic systems including metals, atomic gases, and correlated-electron materials.

In the first year of this project, we demonstrated a new diluted magnetic semiconductor systems based on copper doping of colloidal semiconductor nanocrystals. These materials exhibited an emergent photo-induced magnetization in response to blue/ultraviolet light (Figure 1). The results of this work were written up and published in the very high profile journal *Nature Nanotechnology* (and was also highlighted in an accompanying News and Views article).

Based on this work, we received several invitations to speak at international conferences, including the 2012 SPIE meeting (San Diego, CA).

In the second year of this project we discovered related optically-induced magnetism in the “archetypical” complex oxide material – strontium titanate. This material forms the cornerstone of the new and burgeoning field of complex oxide electronics. It has always been regarded as

a nonmagnetic wide-bandgap semiconductor, but recent measurements have suggested that it may possess subtle magnetic properties, especially if doped with oxygen vacancies. We discovered that oxygen-deficient SrTiO₃ can indeed be magnetized – with light alone – at low temperatures. Moreover, we showed that this magnetization is remarkably persistent – it remains long after (hours to days) the light is turned off -- Figure 2. This work was performed in collaboration with Professor Chris Leighton at the University of Minnesota. These results were written up and again published in the extremely high impact journal *Nature Materials*.

Based on this work, we received many invitations to speak at conferences, including invited talks at HMF-21 (Panama City, FL), SPIE 2014 (San Diego, CA), PASPS-VIII (Washington DC), and PCSI-4 (Santa Fe, NM).

As part of this project, we developed a new capability here at LANL: optically-coupled SQUID magnetometry (Figure 3). Using this technique it is possible to perform magnetization studies whilst illuminating samples with polarization-controlled light. This was written up and published in the *Journal Of Vacuum Science and Technology*, where it was actually the cover article.

In this last year we have finalized and perfected the Time Resolved Faraday Rotation ultrafast optical technique, which we are currently using to explore ultrafast magnetization dynamics in magnetically-doped colloidal nanocrystal materials. We are currently writing up these results for publication.

Impact on National Missions

This project has built Laboratory capabilities in the development of novel materials-synthesis and experimental techniques that enable new scientific discovery at LANL. It is based on recent advances in colloidal growth and tunable magnetic doping of nanocrystals and oxide semiconductors that have already demonstrated new emergent functionality. Our approach goes well beyond this specific example of photo-induced magnetization in doped nanocrystals: long-term advantages and applicability of nano-scale heterostructures and time-resolved magnetization dynamics are very general. The project has advanced new Laboratory capabilities for synthesis and magnetic measurement that underpin a wide variety of Laboratory missions. Demonstration of engineered spin and magnetization interactions at the nanoscale has generated worldwide attention and has formed a robust platform for a nanoscale spintronics and nanoscale photonics program at LANL.

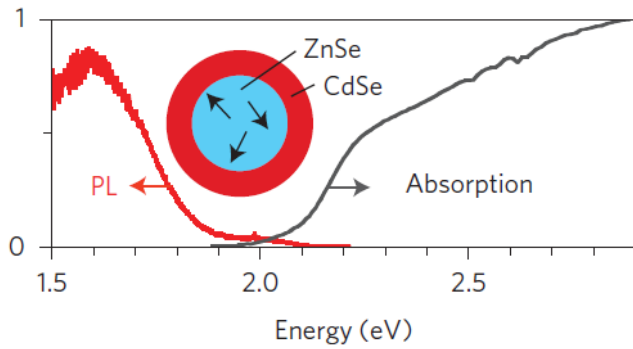

Figure 1. Copper-doped ZnSe/CdSe nanocrystals (above) are a new class of diluted magnetic semiconductor, that exhibits optically-induced changes in magnetization (below). From Pandey, Klimov, Crooker et al, *Nature Nanotechnology* (2012).

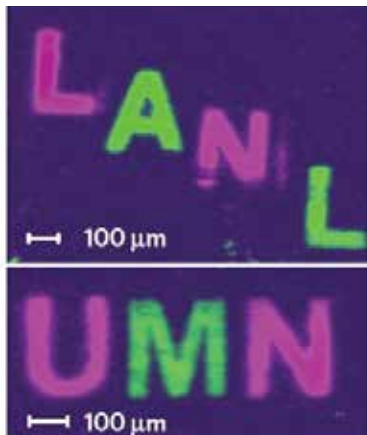

Figure 2. A demonstration that magnetic information can be written into, stored, and read from SrTiO₃ using light alone. The acronyms “LANL” and “UMN” were written using circularly polarized light; purple and green colors correspond to magnetization pointing into and out of the page, respectively. The magnetic images were read out using raster-scanned magnetic circular dichroism. From Rice, Leighton, Crooker et al, *Nature Materials* (2014).

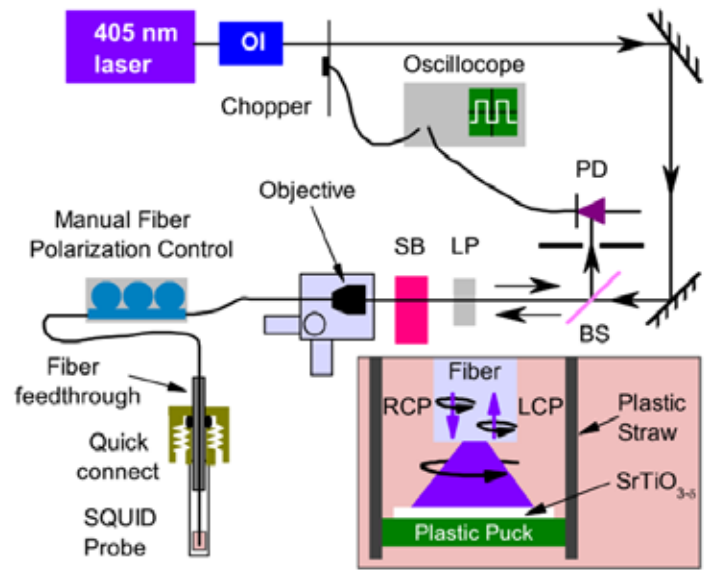

Figure 3. Optically coupled SQUID magnetometry. Mechanically chopped 405-nm light from a laser diode is passed through an optical isolator (OI) and is circularly polarized by a linear polarizer (LP) and Soleil-Babinet compensator (SB) before being coupled into a standard UV single-mode fiber. The light that is back-reflected from the other end of the fiber (in the SQUID magnetometer) follows a time-reversed path back through the fiber, SB, and LP and is directed to a photodiode (PD) using a beam-splitter (BS). Its intensity is zero (it is completely nulled by LP) if the optical polarization at the end of the fiber is exactly LCP or RCP. A manual fiber polarization controller allows to compensate for unwanted strain-induced birefringence in the fiber in order to maintain circular polarization at the sample. Inset: Detailed view of fiber end near sample. The sample is mounted on a plastic Kel-F (polychlorotrifluoroethylene) puck that is held by friction in a plastic straw. From Rice, Leighton, Thompson, Crooker et al, *JVSTB* (2014).

Publications

- Pandey, A., S. Brovelli, R. Viswanatha, L. Li, J. M. Pietryga, V. I. Klimov, and S. A. Crooker. Long-lived photo-induced magnetization in copper-doped ZnSe/CdSe core/shell nanocrystals. 2012. *Nature Nanotechnology*. 7: 792.
- Rice, W. D., P. Ambwani, J. D. Thompson, C. Leighton, and S. A. Crooker. Revealing optically induced magnetization in SrTiO₃ using optically coupled SQUID magnetometry and magnetic circular dichroism. 2014. *Journal of Vacuum Science and Technology B*. 32 (4): 04E102.
- Rice, W. D., P. Ambwani, M. Bombeck, J. D. Thompson, G. Haugstad, C. Leighton, and S. A. Crooker. Persistent optically induced magnetism in oxygen-deficient strontium titanate. 2014. *NATURE MATERIALS*. 13 (5): 481.

Exploiting Metal/Organic Interfaces as Potential Bulk Heterojunctions: Unlocking the Efficiency of Organic Photovoltaics

Hsing-Lin Wang
20120464ER

Abstract

Currently the most commonly used architecture in organic photovoltaic, OPVs, is called a bulk heterojunction or BHJ. The most extensively studied OPVs consist of donor polymer and acceptor molecules (e.g. functionalized C60). In spite of incremental improvements of organic photovoltaic (OPV) efficiency from 1% [1] to 7% [2] over the past two decades, the efficiency of OPVs remains significantly lower than their inorganic counterparts such as Si. However, OPVs are positioned to emerge as a viable power source because they are low cost, light weight, flexible, and easy to manufacture. The potential of using OPV as economically feasible low power sources can be realized only if the scientific community can address the critical issues needed to push the power conversion efficiency (PCE) of OPVs to greater than 10%, a benchmark surpassing any OPVs made with current designs.

Two main challenges that hamper the efficiency of OPVs are 1) poor light harvesting (due to partial overlap of polymer absorption with solar spectrum) and 2) insufficient charge collection due to irreproducible and ineffective BHJ interface.

In this work, we directly confront these issues by adopting an unorthodox approach to develop OPV's with improved efficiency and reproducibility. We will focus our efforts on (a) developing a unique donor-acceptor interface (controlled BHJ) to improve charge separation and collection efficiency, (b) enhancing light absorption by increasing light trapping within the active polymer, as well as synthesizing novel low-band gap polymers with absorption that covers the solar emission from UV to near IR, and (c) enhancing hole-transport by design synthesis of conjugated polymer thin films with improved crystallinity.

Background and Research Objectives

OPVs are a class of solar cells with a promising future.

Reports started appearing as early as 1985, but enormous amounts of work have happened over the last decade. The primary designs for OPVs consist of a bilayer junction, bulk heterojunction and controlled heterojunction. Bulk heterojunction is considered to be the current benchmark for OPVs. [3,4] Despite significant advances, the main reason that has precluded the use of OPVs for applications is their poor efficiency,[5] due to low absorption and mismatch with the solar spectrum,[6] poor charge transport, and inefficient charge collection. [7] Poor efficiency is also largely due to a "trial and error" approach in the synthesis of BHJs. Instead of making incremental improvements, we propose the incorporation of 2D polymers with acceptor molecules to form a bulk heterojunction. The proposed work will not only improve the efficiencies in OPVs but will also confront the reproducibility issue in conventional BHJ OPVs. Moreover, we will use a host of correlated spectroscopy probes to assess electronic states and provide insights into the role of these states in charge transport and charge collection across the donor/acceptor interface, which are critical to photocurrent generation.

Success of this work will allow development of next generation OPV devices with high efficiencies that rival the mono- and polycrystalline Si panels. This will significantly shorten the time frame originally set by the DOE SunShot Initiative to achieve cost competitive solar energy by 2020.

We expect to demonstrate fabrication of BHJs with high surface area and morphology to maximize charge separation and collection efficiencies. We will synthesize conjugated polymers with unprecedented optical and physical properties to enhance the hole mobility and increase absorption overlap with the solar spectrum. Optimizing the interfacial structure and surface chemistry between charge donor and acceptor could lead to enhanced exciton diffusion lengths, charge separation and collection efficiencies, and charge mobility. More-

over, the proposed study offers insights on the interplay between surface area, interfacial structure and device properties. This understanding represents major advances in materials development and device architectures that are necessary to achieve huge leaps in OPV efficiency.

Scientific Approach and Accomplishments

This project mainly focuses on how we can improve the polymer and interfacial structure and properties in order to maximize the charge separation and minimize charge recombination; the end result is the enhancement of overall power conversion efficiency.

We have developed a multi-step synthetic route for the preparation of various 2D conjugated polymer with donor-acceptor backbone and side chain structures allowing fine tuning of the crystallinity and optical properties. Figure 1 shows the molecular structure of six donor-acceptor polymers with various backbone and side chain structures.

Our approach is to synthesize 2D donor-acceptor polymers with the following properties: Optimized absorption spectra cover the range from 300 nm up to 800nm (1.5 eV) and enhanced crystallinity that will give rise to enhanced carrier mobility and interfacial modification to elevate the power conversion efficiency. Figure 2 shows the UV-Vis absorbance spectra of all six 2D polymers in solution. The shoulder bands are typically associated with the enhanced polymer packing (i.e., crystallinity). In addition, P4-P6 exhibit absorption spectra over the range from 300 nm to 770 nm, ideally suited for making OPV devices. The above results also validate our synthetic approach and hypothesis which could be very useful for future materials development.

We have demonstrated fabrication of mesoporous metals (Au, Ag, and TiO₂) with tunable pore size and surface area.

We have established a clear correlation between the polymer structure and the performance characteristics of OPV devices. Polymers with highest crystallinity can have power conversion efficiency of 4.3%, whereas the amorphous polymer has an efficiency of less than 2%, mainly because of the high carrier mobility in highly crystalline polymers, Figure 3.

We have discovered ways to modify the interface between polythiophene and fullerene in bulk heterojunction OPV devices. We have synthesized a series of conjugated oligomers with long alkyl side chain attached to oligothiophenes. Mixing these oligomers with polythiophene and fullerene has shown tremendous impact on the power conversion efficiency of the solar cells from 4.2% to 7%. This change in efficiency clearly indicates how oligothiophene

can revise the interface by reducing the energy barrier for charge carriers to cross the interface.

These polymers have been used for fabricating flexible, volatile and non-volatile memory devices on a conductive polymer substrate. As can be seen in Figure 4, the performance characteristics of the memory devices are not affected by the bending angle of the device.

Impact on National Missions

This work provides a better understanding of the fundamental mechanisms needed to improve OPVs and make them commercially viable. This work addresses optimizing the donor/acceptor interface for enhancing the field of OPV device research. Thus, this work supports the LANL and DOE missions to apply new materials for improved use of renewable (solar) resources, and may impact the nation's overall energy security by reducing energy dependence on foreign oil supplies. The work also supports ongoing efforts at C-Division, as well as the Center for Integrated Nanotechnologies, a DOE-BES user facility. The work here will develop new capabilities in device construction and characterization that is sure to attract new users to CINT. Ultimately, the proposed work will strengthen our ability to prepare next generation organic solar cells and put us in the position to respond to future solar energy calls. Success in this area should be of interest to DOE, as well as DOD sponsors.

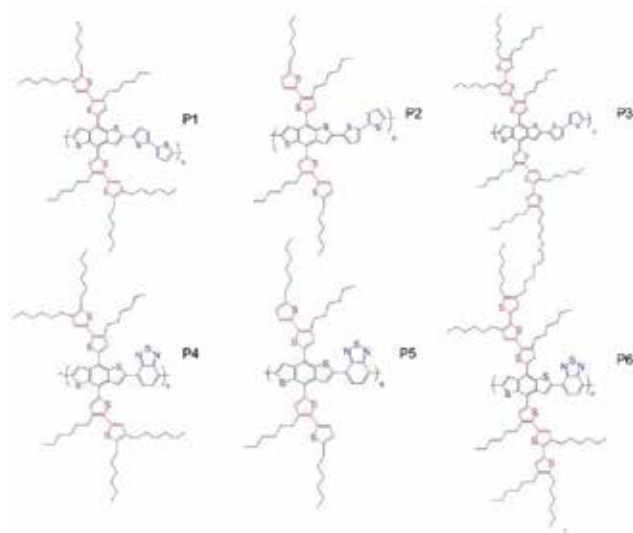

Figure 1. Molecular structure of six 2D polymers. P1-P3 have the same dithiophene backbone but different side chain structures. P4-P6 have the same benzothiadiazole backbone but different backbone structures.

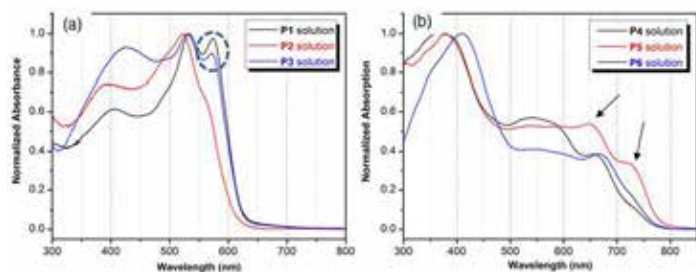

Figure 2. Absorption spectra of polymers P1-P3 (a) and P4-P6 (b). The shoulder band at 580 nm for P1 and P3 suggests an enhanced polymer crystallinity; similarly the shoulder bands at 650 nm and 720 nm also reveals crystalline nature of polymer P5.

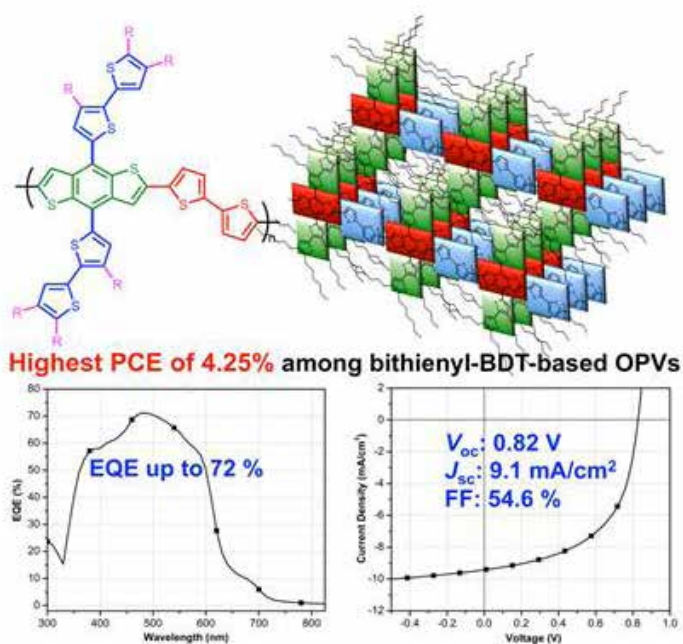

Figure 3. (Top, left) The molecular structure of highly crystalline 2D polymer and the hypothesized packing structure (right). (Bottom left) External quantum efficiency and (right) I-J curve of OPV device showed the highest power conversion efficiency of 4.25%, the highest among polymer solar cells based on two-dimensional (2-D) bithienyl- or terthienyl-substituted benzodithiophene.

Figure 4. a) Appearance in various bent states and (b) variation of current and threshold voltage with different bending radii of the ITO/CP1/Al flexible memory device.

References

1. Tang, C. W.. 2-Layer organic photovoltaic cell . 1986. APPLIED PHYSICS LETTER . 48: 183.
2. Park, S. H., A. Roy, S. Beaupré, S. Cho, N. Coates, J. S. Moon, D. Moses, M. Leclerc, K. Lee, and A. J. Heeger. Bulk heterojunction solar cells with internal quantum efficiency approaching 100%. 2009. NATURE PHOTONICS. 3: 297.

3. Peet, J., A. J. Heeger, and G. C. Bazan. Self-assembly of bulk heterojunction nanomaterials by spontaneous phase separation. 2009. ACCOUNTS OF CHEMICAL RESEARCH . 42: 1700.
4. Peet, J., G. C. Bazan, A. J. Heeger, D. Moses, W. L. Ma, N. E. Coates, and J. Y. Kim. Efficiency enhancement in low-bandgap polymer solar cells by processing with alkane dithiols. 2007. NATURE MATERIALS. 6: 497.
5. Kim, Y., S. Cook, S. M. Tuladhar, S. A. Choulis, J. Nelson, D. D. C. Bradley, M. Giles, I. McCulloch, C. H. HA, and M. REE. A strong regioregularity effect in self-organizing conjugated polymer films and high-efficiency polythiophene:fullerene solar cells. 2006. NATURE. 5: 197.
6. Dibb, G. F. A., M. A. Muth, T. Kirchartz, S. Engmann, H. Hoppe, G. Gobsch, M. Thelakkat, N. Blouin, S. Tierney, M. Carrasco-Orozco, J. R. Durrant, and J. Nelson. Influence of doping on charge carrier collection in normal and inverted geometry polymer:fullerene solar cells. 2013. SCIENTIFIC REPORTS. 3: 3335.
7. LI, G., V. SHROTRIYA, J. HUANG, Y. YAO, T. TOMMORIARTY, K. EMERY, and Y. YANG. High-efficiency solution processable polymer photovoltaic cells by self-organization of polymer blends. 2005. NATURE MATERIALS. 4: 864.

Publications

- Kang, L. L., P. Xu, B. Zhang, H. H. Tsai, X. J. Han, and H. L. Wang. Laser wavelength- and power-dependent plasmon-driven chemical reactions monitored using single particle surface enhanced Raman spectroscopy. 2013. CHEMICAL COMMUNICATIONS. 49 (33): 3389.
- Kuo, C. Y., W. Nie, H. Tsai, H. J. Yen, A. D. Mohite, G. Gupta, A. M. Dattelbaum, D. J. William, K. C. Cha, Y. Yang, L. Wang, and H. L. Wang. Structural Design of Benzo[1,2-b:4,5-b']dithiophene-Based 2D Conjugated Polymers with Bithienyl and Terthienyl Substituents toward Photovoltaic Applications. 2014. MACROMOLECULES. 47 (3): 1008.
- Kuo, C. Y., Y. C. Huang, C. Y. Hsiow, Y. W. Yang, C. I. Huang, S. P. Rwei, H. L. Wang, and L. Wang. Effect Side-Chain Architecture on the Optical and Crystalline Properties of Two-Dimensional Polythiophenes. 2013. MACROMOLECULES. 46 (15): 5985.
- Kuo, C. Y., Y. C. Huang, C. Y. Hsiow, Y. W. Yang, C. I. Huang, S. P. Rwei, H. L. Wang, and L. Wang. Effect Side-Chain Architecture on the Optical and Crystalline Properties of Two-Dimensional Polythiophenes. 2013. MACROMOLECULES. 46 (15): 5985.

-
- Li, Q., P. Xu, B. Zhang, G. Wu, H. T. Zhao, E. G. Fu, and H. L. Wang. Self-supported Pt nanoclusters via galvanic replacement from Cu₂O nanocubes as efficient electrocatalysts. 2013. *NANOSCALE*. 5 (16): 7397.
- Park, Y. I. I., B. Zhang, C. Y. Kuo, J. S. Martinez, J. Park, S. Mallapragada, and H. L. Wang. Stimuli-Responsive Poly-N-isopropylacrylamide: Phenylene Vinylene Oligomer Conjugate. 2013. *JOURNAL OF PHYSICAL CHEMISTRY C*. 117 (15): 7757.
- Park, Y. I. I., C. Y. Kuo, J. S. Martinez, Y. S. Park, O. Postupna, A. Zhugayevych, S. Kim, J. Park, S. Tretiak, and H. L. Wang. Tailored Electronic Structure and Optical Properties of Conjugated Systems through Aggregates and Dipole-Dipole Interactions. 2013. *ACS APPLIED MATERIALS & INTERFACES*. 5 (11): 4685.
- Park, Y. I. I., Y. S. Park, J. Gao, J. K. Grey, C. C. Wang, M.A. Johal, J. Park, H. Y. Woo, and H. L. Wang. Water-soluble PPV and C-60 nanocomposite with enhanced miscibility and enhanced photo-induced charge transfer through ground state electrostatic interactions. 2014. *POLYMER*. 55 (3): 855.
- Park, Y. I., B. Q. Zhang, C. Y. Kuo, J. S. Martinez, J. Park, S. Mallapragada, and H. L. Wang. Stimuli-Responsive Poly-N-isopropylacrylamide: Phenylene Vinylene Oligomer Conjugate. 2013. *JOURNAL OF PHYSICAL CHEMISTRY C*. 117 (15): 7757.
- Park, Y. S., Y. F. Chen, Y. Ghosh, A. Piryatinski, P. Xu, N. H. Mack, H. L. Wang, V. I. Klimov, J. A. Hollingsworth, and H. Htoon. Strong Photon Bunching in Individual Nanocrystal Quantum Dots Coupled to Rough Silver Film. 2012. In *2012 CONFERENCE ON LASERS AND ELECTROOPTICS (CLEO)*. , p. -.
- Park, Y. S., Y. Ghosh, Y. Chen, A. Piryatinski, P. Xu, N. H. Mack, H. L. Wang, V. I. Klimov, J. A. Hollingsworth, and H. Htoon. Super-Poissonian Statistics of Photon Emission from Single CdSe-CdS Core-Shell Nanocrystals Coupled to Metal Nanostructures. 2013. *PHYSICAL REVIEW LETTERS*. 110 (11): -.
- Sasaki, D. Y., N. Zawada, S. F. Gilmore, P. Narasimmaraj, M. A. A. Sanchez, J. C. Stachowiak, C. C. Hayden, H. L. Wang, A. N. Parikh, and A. P. Shreve. Lipid Membrane Domains for the Selective Adsorption and Surface Patterning of Conjugated Polyelectrolytes. 2013. *LANGMUIR*. 29 (17): 5214.
- Yen, H. J., H. Tsai, C. Y. Kuo, W. Nie, A. D. Mohite, G. Gupta, J. Wang, J. H. Wu, G. S. Liou, and H. L. Wang. Flexible memory devices with tunable electrical bistability via controlled energetics in donor-donor and donor-acceptor conjugated polymers. 2014. *JOURNAL OF MATERIALS CHEMISTRY C*. 2 (22): 4374.

High Performance Thin Film Super Capacitors

Aditya Mohite
20130527ER

Abstract

An electrochemical double layer capacitor (EDLC), also known as a supercapacitor, is an energy storage device that has energy densities typically 100-1000 times greater than conventional electrostatic capacitors. In contrast with traditional capacitors, electric double layer capacitors do not have a conventional dielectric material. Instead two high surface area electrodes (typically activated carbon) are separated by an electrolyte. Upon application of a voltage, an “electrical double layer” is formed at the electrode surfaces with atomic scale charge separation (on the order of a few nanometers) creating a very large charge storage capacity. Microscale supercapacitors provide an important complement to batteries in a variety of applications, including portable electronics. Although they can be manufactured using a number of printing and lithography techniques, continued improvements in cost, scalability and form factor are required to realize their full potential. A major bottleneck in their wide spread use is achieving high energy and power densities at a low cost. In this proposal, we directly confronted these issues by developing a graphene oxide (GO) based thin film micro supercapacitor first demonstrated by a team member of this proposal (W. Gao) that uses an innovative and industrially scalable laser patterning approach. In our device, GO acts as solid-state electrolyte/separator that separates the laser exposed/electrically conducting reduced graphene oxide (RGO). Such devices can (theoretically) outperform existing state-of-the-art thin film micro supercapacitors. In this project, we aimed to 1) increase the energy density of the GO supercapacitor to a level comparable to Li-ion batteries, 2) increase the power density while maintaining fast charging/discharging rates and 3) improve the mechanical strength and flexibility of the thin film GO supercapacitor.

Background and Research Objectives

The exponential growth of electronic applications over the years has resulted in a growing demand for high per-

formance, low cost energy storage devices. Microscale supercapacitors are widely being explored for applications such as portable electronics, biomedical implants, active Radio Frequency Identification tags and structure-embedded micro-sensors where no replacement or maintenance is required. The state-of-the-art micro-supercapacitors are manufactured using a number of printing and lithography techniques. Continued improvements in performance, cost, scalability and form factor are required to realize their uninhibited use in the above applications. Improvements in energy density by increasing the effective surface area currently require the use of expensive techniques such as photo- or e-beam lithography. Thus, development of compact and flexible energy storage devices that can be easily integrated on an electronic circuit still remains a significant challenge.

Graphene Oxide (GO) has recently attracted a great deal of attention, largely because it is an outstanding active material for supercapacitors. Chemically activated or laser treated GO with superior energy and power densities compared to conventional supercapacitor material, such as activated carbon, has recently been reported. Specifically, we have previously demonstrated proof-of-principle supercapacitor patterns on macro-scale devices (~ 1-5 mm) utilizing a laser to form a reduced graphene oxide (RGO) pattern on a free-standing GO film (fig. 2). Laser treatment of GO reduces the GO to RGO that serve as supercapacitor electrodes. This laser-patterning process has resulted in capacitances as high as 2.5 mF/cm² with additional organic electrolyte. The area capacitance values in existing electrochemical micro capacitors fall between ~0.4 and 2 mF/cm². The concentric circular in-plane structure offered the highest capacitance density (energy density 4.3x10⁻⁴ Wh/cm³), whereas the sandwich structure resulted in the highest power density (9.3 W/cm³) in our system. However, further engineering of the GO material by improving the laser patterning process should lead to a significant improvement in supercapacitor performance (specifically with energy density).

Another advantage is that GO films can be coated onto any substrate, which allows for greater flexibility in the design, engineering and manufacturing of these thin film devices. Further modification of the GO may also be needed and we have extensively investigated the chemical functionalization and photochemical properties of GO, which will be critical for achieving the proposal objectives.

Scientific Approach and Accomplishments

The goal of this Engineering ER project was to develop thin-film flexible and stable Graphene Oxide based laser patterned supercapacitors with high energy density and power density. The key enabling technology was the role of Graphene Oxide as a proton hopping membrane. By using GO as the solid state electrolyte, we demonstrated laser patterned supercapacitors with varying size and dimension, that results in an improvement in the energy density 4 to 18 mW/cm³ and power density from 80 to ~250 mW/cm³ respectively. However, we were limited by the use of GO as an electrolyte as it was highly humidity dependent and required >70% humidity to transport the protons efficiently.

To overcome this challenge we developed a new strategy of incorporating conventionally used ionic liquids as an electrolyte but in its solid state form. This was a very significant finding. We used a “microwave sol-gel” technique whereby the electrolytes after infiltration into GO (or any porous materials) can be converted to its almost solid state form, thus making the device entirely solid state, unlike conventionally used supercapacitors today.

This was discovered close to the last 4-5 months of the project and so as a proof of principle we demonstrated a supercapacitor fabricated using high surface area (2000 m²/g) carbon fibers made using the electrospinning method. Supercapacitors exhibited a very high capacitance of 100-200 Farads/gm. This resulted in an energy density of 400 W/cm³ and a power density of 1-2 W/cm³, which is on-par with the state-of-the-art supercapacitors available commercially.

The project resulted in five published papers, two conference papers, five in preparation two submitted. We were also able to obtain external funding on Graphene-Oxide-based, remotely readable, tamper-evident seal with compressive sensing- 150 K PI: David Mascarenas

Impact on National Missions

This project has directly supported a LANL Materials Grand Challenge aimed at controlling the electronic functionality. These devices would be ideal for remote applications requiring low-cost, light weight devices for on-field personnel and as sensors in circuits to detect breaks. They could also

serve as complementary energy storage devices in combination with a battery and for starters for vehicles.

Publications

Gao, W., C. Galande, A. Mathkar, T. Narayanan, A. Mohite, and P. Ajayan. Science and Engineering of Graphene Oxide. 2014. Particle & Particle Systems Characterization. 31 (6): 619.

Mascarenas, D., G. Gupta, and A. Mohite. A graphene-oxide (GO) based tamper-evident seal. To appear in The 2nd International Conference on Advances in Structural Health Management and Composite Structures - ASHMCS, 27-29 August 2014 Jeonju, Jeonbuk. (Jeonju, Jeonbuk, 27-29 August 2014).

Sharp, N., A. Kuntz, C. Brubaker, S. Amos, W. Gao, C. Farrar, A. Mohite, G. Gupta, and D. Mascarenas. Endowing Structures with a Nociceptive Sense Enabled by a Graphene-Oxide Sensing Skin. Presented at International Modal Analysis Conference. (Orlando, Feb3-6 2014).

Sharp, N., A. Kuntz, C. Brubaker, W. Gao, D. Mascarenas, G. Gupta, A. Mohite, C. Farrar, and S. Amos. Crack Detection Sensor Layout and Bus Configuration Analysis. SMS-100220.R1 Accepted 2014.

Frustrated Materials

Cristian D. Batista

20120751PRD2

Introduction

One of the most spectacular manifestations of geometrical frustration is the presence of the novel states of matter and associated phase transitions. These novel phases arise as a compromise between the opposite tendencies that are inherent to frustrated geometries. A triangular plaquette is an archetypal building block for lattices with geometrical frustration. Many unusual magnetic and orbital orderings in frustrated magnets are best understood from the viewpoint that the system is in the vicinity of a metal-insulator transition. It is a challenging theoretical task to model these systems which lie in the intermediate-coupling regime between deep Mott insulator and the metallic phase. To carry out such studies, we will employ a combination of analytical and numerical techniques. We will use mean field and semi-classical techniques for computing thermodynamic properties. For the numerical approach we will implement a Monte Carlo algorithm for solving the problem of itinerant electrons interacting with localized classical spins. Since the action is quadratic in the fermion operators, the itinerant electrons can be integrated out exactly, leading to an effective non-local classical action for the local moments that will be solved by applying the Metropolis algorithm. All the thermodynamic properties will be computed under control because the statistical error can be made arbitrarily small by increasing the sample size. The temperature dependence of the thermodynamic quantities will be directly compared against the experiments.

Benefit to National Security Missions

The lack of proper theoretical tools daunted by the complexity of actinides and other correlated materials has slowed down the progress towards modeling their properties under extreme conditions. Actinide based materials are of primary interest for energy security applications relevant for DOE/NNSA and DOE/SC. Moreover, our ability of predicting the behavior of correlated materials is crucial for optimizing response functions, such as magneto-electric susceptibility, which are nec-

essary for sensing applications relevant for DoD basic defense applications (including detection), DHS basic homeland security (including detection) and Intelligence agencies. By developing computational methods for modeling correlated materials with competing (frustrated) interactions, we are responding to the national need of predicting actinide, and more in general, correlated materials properties for energy security applications. An outcome of this project is the development of a novel code which incorporates correlated effects to ab initio quantum molecular dynamics, a method that can be ultimately used for simulating electronic and structural properties of actinides and other correlated materials under extreme conditions. This is a first step towards reaching the level where studies of actinide properties can be predicted from first principles computer-based simulations, thus avoiding costly experiments and contributing significantly to the reliability of the nuclear stockpile. This is a direct response to the DOE/NNSA/Defense programs. The outcome of this project (new code for performing molecular dynamics of correlated materials) can also be used for studying the effects matter-radiation in extremes relevant for MARIE.

Progress

The research of Dr. Gia-Wei Chern has been focused on frustrated systems in general, and particularly in highly frustrated magnetism. The main goal here is to have a better understanding of these intriguing complex systems and to design and control their novel properties for applications to, e.g. magnetic storage, computing, and sensing.

Working with his collaborators at LANL, Dr. Chern has studied a novel magnetic field induced phase transition in vanadium spinels. The magnetic ions in these compounds form a highly frustrated pyrochlore lattice, which is a three-dimensional network of corner-sharing tetrahedron. The vanadium spinels have been a canonical system for studying frustrated spin-orbital interac-

tions. Taking advantage of the high magnetic field facility at LANL, experimentalists have uncovered an interesting phase transition induced by magnetic field in these compounds. Gia-Wei and his colleagues have developed a theoretical model which successively explains the experimental results.

Another main area of his research is the study of artificially created frustrated systems, in particular the so-called artificial spin ice. Artificial spin ice is a booming field in condensed matter physics. Among the most exciting recent developments is the emergence of magnetic monopoles in these materials. Emergent phenomena, which until now have only been accessible at low-T, will then be tailor-designed to manifest at room temperature. In particular, the existence of mobile magnetic monopoles coupled to magnetic fields provides a promising approach to realize magnetricity, the control and manipulation of magnetic currents. With the rapid progress in nano-fabrications, it is now possible to realize artificial spin ice in various lattice geometries. One of the key advantages of these systems is that they allow direct experimental access to the microscopic degrees of freedom.

With collaborators in LANL, Dr. Chern has proposed the first feasible design of a three-dimensional artificial spin ice that has exactly the same lattice topology as the natural spin-ice compounds. Experimental realization of such systems will allow us to study the dynamics of magnetic monopoles in these novel materials taking advantage of the powerful tools of modern nanotechnology. In addition, the earlier proposal of composite monopole quasiparticles, namely an emergent monopole surrounded by background magnetic charges, has been experimentally confirmed; Dr. Chern was also involved in the theoretical analysis of this work.

Motivated by recent advances in thin-film growth technology, Dr. Chern also studied the triangular Ising antiferromagnetic thin films. He and his colleagues discovered unusual re-entrant phase transitions which depend on the number of layers in the system. This study added a surprising chapter to this well studied canonical system of frustrated magnetism.

Finally, Gia-Wei has also contributed to the study of emergent topologically non-trivial magnetic orderings in Kondo Lattice models on geometrically frustrated Kagome Lattices.

Future Work

Add electronic correlations to Molecular Dynamics in order to be able to simulate actinide metals

The basic idea is to exploit the Kernel Polynomial method

that we have developed for solving frustrated Kondo lattice models. This classical degrees of freedom are now the positions of the ions (instead of the local spin directions).

Compute thermodynamic and transport properties of metallic spin ices

A similar study for the metallic spin-ice systems will shed some light on the strange chiral phase with disordered spins recently observed in pyrochlore $\text{Pr}_2\text{Ir}_2\text{O}_7$. We will examine the dynamics of monopoles induced by the electron-mediated RKKY interactions.

Metal-insulator transitions in frustrated magnets

Many of the unusual magnetic and orbital ordering in pyrochlore magnets are best understood from the viewpoint that the system is close to a metal-insulator transition. Indeed, some of them also exhibit a room-temperature metal-insulator transition that is accompanied by magnetic ordering. We will explore the role of orbital degrees of freedom in such transitions for multiband Hubbard models.

Mott transitions and physics in strongly coupled spin-orbital systems

Strong spin-orbit coupling can dramatically change the band structure of weakly interacting solids, leading to band insulator with a nontrivial topology. It has been shown recently that the Kitaev model can be realized in iridium oxides A_2IrO_3 that are Mott insulators with strong spin-orbit coupling. We will investigate the general properties of topological Mott insulators, their experimental characterization, and their connection with topological band insulators when the system undergoes a Mott transition.

Quasiparticles of orbital ice

Recently, we have uncovered a nontrivial many-body ground-state solution for this system. We will study the elementary excitations in orbital ice and to pursue an algebraic approach for exactly solving the quantum orbital model.

Conclusion

- Find novel magnetic orderings in double-exchange models and spin-density wave instability of the Hubbard model on frustrated lattices.
- Understand the thermodynamic properties of metallic spin ice, particularly the exotic chiral spin-liquid phase in pyrochlore compound $\text{Pr}_2\text{Ir}_2\text{O}_7$.
- Develop theoretical models for electron transport in the emergent Coulomb phase in metallic spin ice systems.
- Develop numerical algorithms for studying the order-by-disorder phenomenon in frustrated magnets.

- Provide a theoretical modeling of magnetic and orbital ordering in vanadium spinels.

Publications

- Chern, , Chien, and Di Ventura. Dynamically generated flat-band phases in optical kagome lattices. 2014. PHYSICAL REVIEW A. 90 (1).
- Chern, , Maiti, R. M. Fernandes, and Woelfle. Electronic Transport in the Coulomb Phase of the Pyrochlore Spin Ice. 2013. PHYSICAL REVIEW LETTERS. 110 (14).
- Chern, , Reichhardt, and C. J. O. Reichhardt. Avalanches and disorder-induced criticality in artificial spin ices. 2014. NEW JOURNAL OF PHYSICS. 16.
- Chern, , Reichhardt, and Nisoli. Realizing three-dimensional artificial spin ice by stacking planar nano-arrays. 2014. APPLIED PHYSICS LETTERS. 104 (1).
- Chern, , and Wu. Four-Coloring Model and Frustrated Superfluidity in the Diamond Lattice. 2014. PHYSICAL REVIEW LETTERS. 112 (2).
- Chern, G. W., C. Reichhardt, and C. J. O. Reichhardt. Frustrated colloidal ordering and fully packed loops in arrays of optical traps. 2013. PHYSICAL REVIEW E. 87 (6): -.
- Chern, G. W., M. Morrison, and C. Nisoli. Degeneracy and criticality from emergent frustration in artificial spin ice. 2013. Physical Review Letters. 111: 177201.
- Chern, G. W., R. M. Fernandes, R. Nandkishore, and A. V. Chubukov. Broken translational symmetry in an emergent paramagnetic phase of graphene. 2012. PHYSICAL REVIEW B. 86 (11): -.
- Chern, G. W., and C. D. Batista. Spontaneous quantum Hall effect via a thermally induced quadratic Fermi point . 2012. Physical Review Letters. 109: 156801.
- Chern, G. W., and O. Tchernyshyov. Magnetic charge and ordering in kagome spin ice. 2012. PHILOSOPHICAL TRANSACTIONS OF THE ROYAL SOCIETY A-MATHEMATICAL PHYSICAL AND ENGINEERING SCIENCES. 370 (1981): 5718.
- Chern, G. W., and R. Moessner. Dipolar Order by Disorder in the Classical Heisenberg Antiferromagnet on the Kagome Lattice. 2013. PHYSICAL REVIEW LETTERS. 110 (7): -.
- Choi, E. S., G. W. Chern, and N. B. Perkins. Chiral magnetism and helimagnons in a pyrochlore antiferromagnet. 2013. PHYSICAL REVIEW B. 87 (5): -.
- Choi, E., G. W. Chern, and N. B. Perkins. Helimagnons in a chiral ground state of the pyrochlore antiferromagnets. 2013. EPL. 101 (3): -.
- Gilbert, I. a. n., Chern, Zhang, O'Brien, Fore, Nisoli, and Schiffer. Emergent ice rule and magnetic charge screening from vertex frustration in artificial spin ice. 2014. NATURE PHYSICS. 10 (9): 671.
- Knolle, J., G. -W. Chern, D. D. L. Kovrizhin, R. Moessner, and N. B. Perkins. Raman Scattering Signatures of Kitaev Spin Liquids in A2IrO3 Iridates. To appear in Physical Review Letters.
- Lin, , Kamiya, Chern, and C. D. Batista. Stiffness from Disorder in Triangular-Lattice Ising Thin Films. 2014. PHYSICAL REVIEW LETTERS. 112 (15).
- Mun, E. D., Chern, Pardo, Rivadulla, Sinclair, H. D. Zhou, V. S. Zapf, and C. D. Batista. Magnetic Field Induced Transition in Vanadium Spinel. 2014. PHYSICAL REVIEW LETTERS. 112 (1).
- Perkins, N. B., G. W. Chern, and W. Brenig. Raman scattering in a Heisenberg $S=1/2$ antiferromagnet on the anisotropic triangular lattice. 2013. PHYSICAL REVIEW B. 87 (17): -.
- Rahmani, , and Chern. Universal Renyi mutual information in classical systems: The case of kagome ice. 2013. PHYSICAL REVIEW B. 88 (5).
- Rahmani, A., and G. W. Chern. Universal Renyi mutual information in classical systems: The case of kagome ice. 2013. PHYSICAL REVIEW B. 88 (5): -.
- Zhang, S., I. Gilbert, C. Nisoli, G. W. Chern, M. J. Erickson, L. O'Brien, C. Leighton, P. E. Lammert, V. H. Crespi, and P. Schiffer. Crystallites of magnetic charges in artificial spin ice. 2013. NATURE. 500 (7464): 553.

Materials for the Future

Postdoctoral Research and Development
Continuing Project

Designing and Probing Novel Materials by Pressure Tuning of Nanocrystals

Hongwu Xu

20120753PRD2

Introduction

Nanocrystals, which are between 1 and 100 nm in size and are structurally defect-free and possess unique properties compared to their bulk counterparts. Pressure tuning of nanocrystals is a novel approach to designing, developing, and probing new nanostructured materials. At high hydrostatic pressure and/or deviatoric stress, nanocrystals may undergo structural transformations to other phases and coalesce into one-, two- and three-dimensional superlattices and mesostructures, potentially leading to new physical properties. Using lead chalcogenide (e.g., PbSe) or metal (e.g., Pt) as a model system, this project focuses on investigations of pressure-induced behavior of nanocrystals mainly using small-angle and wide-angle synchrotron X-ray scattering (SAXS and WAXS) coupled with diamond-anvil cell (DAC) techniques. Major tasks include: 1) synthesize series of lead chalcogenide nanocrystals of various particle sizes, morphology and capping ligands using wet-chemical and other methods; 2) characterize the obtained nanoparticle samples using powder X-ray diffraction, scanning and transmission electron microscopy and other methods; and 3) employ several high-pressure techniques including SAXS, WAXS, Raman, absorption and emission spectroscopies to determine pressure-tuned structural stability, phase transformations, mechanical and optical properties of random “amorphous” and assembled ordering nanocrystals. In particular, the combined in-situ high-pressure SAXS and WAXS techniques will allow examination of structural variations in both nanocrystals (atomic structures, WAXS) and their assembled architectures (mesoscale superlattices, SAXS). The obtained results will shed important lights on structural mechanisms underlying the formation of novel high-pressure nanophases and their assembled superlattices. This research is expected to open up a new direction in high-pressure nanomaterials science by exploring new phenomena and tuning mechanisms for a wide spectrum of nanoparticles and their building blocks, with great potential for technological applications.

Benefit to National Security Missions

This project represents a research topic with great scientific value and tremendous potential for technological applications. Through the state-of-the-art in-situ high-pressure small- and wide-angle synchrotron X-ray scattering measurements of series of lead chalcogenide and metal nanocrystals, this work will shed important lights on structural mechanisms underlying the formation of novel chalcogenide and metal nanocrystals and their assembled superlattices at high hydrostatic pressure and/or deviatoric stress. More broadly, the obtained results will have applications/implications for controlled nanoparticle synthesis and for design and fabrication of novel structured nanomaterials with potential, enhanced or newly emerging properties. The use of pressure will enable systematic manipulation of the nanophases and their assembled architectures (e.g., interparticle spacing), thereby enabling tuning of their properties for specific applications. This research is expected to open up a new direction in high-pressure nanomaterials science by exploring new phenomena and tuning mechanisms for a wide spectrum of nanoparticles and their building blocks. Examples of potential applications include catalysts, solar cells, optoelectronic and thermoelectric devices. Using pressure as a tool/variable, this research seeks fundamental understanding of the structures and properties of novel nanomaterials, and is tied to missions in DOE office of Science and NSF, to DoD, DHS, IC, and other DOE agencies, as well as to all the three themes of LANL's Materials Grand Challenge (defects and interfaces, extreme environments, and emergent phenomena), as well as MaRIE.

Progress

During the past year, we have made tremendous progress in this project. Major achievements include:

Pressure-Induced Switching between Amorphization and Crystallization in PbTe Nanoparticles

Combining in situ high-pressure X-ray scattering with

transmission electron microscopy, we investigated the pressure-induced structural switches between the rock salt and amorphous phases as well as the associated mechanisms of their crystallization and growth in 6 nm PbTe nanocrystal. It was observed that rock salt PbTe nanocrystal started to become amorphous above 10 GPa and then underwent a low-to-high density amorphous phase transformation at pressures over 15 GPa. The low-density amorphous phase exhibited a structural memory of the rock salt phase, as manifested by a backward transformation to the rock salt phase via single nucleation inside each nanoparticle upon the release of pressure. In contrast, the high-density amorphous phase remained stable and could be preserved at ambient conditions. In addition, electron beam-induced heating could drive a recrystallization of the rock salt phase on the recovered amorphous nanoparticles. These studies provide significant insights into structural mechanisms for pressure-induced switching between amorphous and crystalline phases as well as their associated growth processes.

Self-Assembled PbSe Nanocrystal Superlattices and Their Energy Landscape

We systematically investigated the self-assembly behavior of PbSe nanoparticles with different sizes ranging from 3 nm to 10 nm, using synchrotron small angle x-ray scattering (SAXS) and wide angle x-ray scattering (WAXS) techniques. It is found that either body-centered-cubic (bcc) or face-centered-cubic (fcc) superstructure can be preferably formed based on the size and/or shape of PbSe nanoparticles. Additionally, by using different dispersion solvents (aliphatic hexane or aromatic toluene), we synthesized three types of PbSe NC superlattices—bcc, body-centered tetragonal (bct), and fcc—as confirmed by synchrotron SAXS. Through collaboration with Prof. Alex Navrotsky's group at UC Davis, we have for the first time determined the energy landscape of self-assembled PbSe superlattice using solution calorimetry with hexane as the solvent. The calorimetric measurements reveal that the bcc superlattice is the energetically most stable polymorph, with the bct being 0.32 and the fcc 0.55 kJ/mol higher in enthalpy. This stability sequence is consistent with the decreased packing efficiency of PbSe NCs from bcc (17.2%) to bct (16.0%) and to fcc (15.2%). The small enthalpy differences among the three polymorphs confirm a closely spaced energy landscape and explain the ease of formation of different NC superlattices at slightly different synthesis conditions.

Solvent-Mediated Self-Assembly of Pt Nanocube Superlattices

Through the control over solvent-ligand interactions, we show that Pt nanocubes can be selectively assembled into two distinct types of superlattices in the form of 2D thin

films: simple cubic and body-centered tetragonal structures. Detailed translational and orientational characteristics of these superstructures were determined using a transmission electron microscopy tomographic technique with 3D reconstruction analysis. The formation of these distinct superlattices is the result of a delicate choice of solvent (i.e., aliphatic hexane or aromatic toluene hydrocarbons), which serves as a dispersion medium to fine-tune the relative strengths of ligand–ligand and ligand–solvent interactions during the self-assembly process. This work provides important insights into the effects of ligand–solvent interactions on superlattice formation from nonspherical nanoparticles.

Future Work

In FY15, we will perform the following tasks: 1) Prepare long-range ordered lead chalcogenide supercrystals or “single supercrystals”, based on the experience gained during the past two years in colloidal nanoparticle self-assembly. These supercrystals will then be thoroughly characterized using the integrated small-angle and wide-angle X-ray scattering (SAXS and WAXS) techniques at CHESS, Cornell University. The measurements will yield complete sets of diffraction patterns in various orientations, which are needed to construct the three-dimensional (3D) superstructures of these mesoscale crystals. An important goal of this study is to understand the correlations between the atomic lattice structures and the nanocrystal superstructures within “single supercrystals”, and to discover/characterize resulting physical properties. 2) Extend our calorimetric experiments of lead chalcogenide nanoparticle superlattices from room temperature to high temperature. We have characterized temperature-induced phase transitions of nanoparticle superlattices using synchrotron X-ray scattering; the calorimetric measurements will allow determination of the corresponding energetics underlying these intriguing superlattice transitions at elevated temperatures. This work is a continuous collaboration with Prof. Navrotsky's group at UC Davis, which has a world-leading thermochemistry lab. 3) Perform series of in-situ synchrotron SAXS/WAXS experiments on self-assembly processes of nanoparticles into superlattices using the newly developed setup at CHESS. The goal is to understand the roles of various factors such as solvent, ligand, and nanoparticle size/shape in the formation of resulting superlattices. 4) Analyze the SAXS/WAXS data collected in FY14, summarize the results and write papers for publication. We anticipate publishing 2-3 additional peer-reviewed papers in high-profile journals.

Conclusion

Through the state-of-the-art in-situ small- and wide-angle synchrotron X-ray scattering measurements of the se-

ries of lead chalcogenide nanocrystals, this research will provide important insights into rational design of related structured nanomaterials with enhanced or newly emerging properties. Specific results include: 1) development of novel routes/procedures for controlled synthesis of lead chalcogenide nanocrystals; 2) characterization of their compositions, sizes, shapes and surface structures; and 3) determination of the formation mechanisms and governing factors responsible for structural stability of high-pressure nanophases and their assembled architectures. We expect to publish 3-5 high-impact papers in peer-reviewed professional journals.

Publications

- Quan, Z. W., Z. P. Luo, Y. X. Wang, H. W. Xu, C. Y. Wang, Z. W. Wang, and J. Y. Fang. Pressure-Induced Switching between Amorphization and Crystallization in PbTe Nanoparticles. 2013. *NANO LETTERS*. 13 (8): 3729.
- Quan, Z., D. Wu, J. Zhu, W. H. Evers, J. M. Boncella, L. D. A. Siebbeles, Z. Wang, A. Navrotsky, and H. Xu. Energy landscape of self-assembled superlattices of PbSe nanocrystals. 2014. *Proceedings of the National Academy of Sciences*. 111 (25): 9054–9057.
- Quan, Z., H. Xu, C. Wang, X. Wen, Y. Wang, J. Zhu, R. Li, C. Sheehan, Z. Wang, D. M. Smilgies, Z. Luo, and J. Fang. Solvent-mediated self-assembly of nanocube superlattices. 2014. *J. Am. Chem. Soc.* 136 (4): 1352.

NMR Study of Quantum States of Matter

Joe D. Thompson
20130780PRD1

Introduction

There are thousands of examples of a transition at finite temperature from a magnetically ordered state to a magnetically disordered state. At such a classical phase transition, thermal fluctuations due to the finite temperature environment drive the transition. But, it also is possible theoretically to have a transition from magnetically ordered to disordered states at absolute zero temperature where there are no thermal fluctuations. In this case the transition is driven solely by rules of quantum mechanics. Though theoretically possible, there are a growing number of experiments suggesting that such a quantum-driven transition exists, but none of these examples can be explained completely with existing theory. Further, experiments during the last decade have found that an unconventional form of superconductivity tends to appear in the vicinity of a quantum magnetic transition, but the possible relationship between quantum fluctuations at this zero-temperature transition and unconventional superconductivity remains an outstanding question. Nuclear magnetic resonance (NMR) techniques are a particularly powerful probe of the nature of quantum fluctuations and their possible role in producing unconventional superconductivity and will be used to study a prototypical example CeRhIn₅ whose magnetic transition can be tuned by applied pressure toward zero temperature where superconductivity emerges. The role of intentionally introduced disorder on the nature and effect of quantum fluctuations also is an important open question that will be addressed by systematically replacing Ce by La and In by Sn in CeRhIn₅. These experiments will provide critical tests of theoretical models of quantum phase transitions, which ultimately should enable a predictive methodology for the discovery of superconductors for energy conservation applications.

Benefit to National Security Missions

Unconventional superconductivity holds promise for technologies that directly support DOE/SC energy missions. But, how and where that superconductivity might

appear cannot be predicted. Empirically, experiments have shown that this superconductivity frequently appears as a magnetic transition is tuned to zero temperature, but the nature of the quantum excitations and how they might induce superconductivity are major unanswered questions. Fundamentally new understanding of the mechanism of unconventional superconductivity and its possible relationship to quantum fluctuations is needed to be able to predict how and when superconductivity appears. Success in this project will provide basic new understanding of materials and how quantum fluctuations induce new quantum states of electrons. With unconventional superconductivity also found recently in plutonium-based materials, superconductivity itself can be used to inform a much clearer perspective of states of matter than can arise from the electronic complexity of Pu. Understanding this complexity underpins the abilities to predict the performance of Pu-based fuels for nuclear energy production and the surety of nuclear weapons as well as the efficient management of Pu-waste.

Progress

Nuclear magnetic resonance (NMR) techniques have been used to make progress along three complementary paths: the study of quantum criticality in CeRhIn₅, investigation of the nature of possible unconventional superconductivity in U₂PtC₂ and its possible relationship to quantum criticality, and the study of PuRhIn₅, which is an isostructural Pu-analog of CeRhIn₅. Progress in each of these areas is described sequentially.

CeRhIn₅

In preparation for a search for pressure-induced quantum criticality in the presence of a modest magnetic field, two samples of CeRhIn₅ were mounted with two orthogonal crystallographic orientations in a pressure cell and the assembly tested successfully to the target pressure of 2 GPa. Measurements of the NMR Knight shift, a measure of the spin susceptibility, confirm that

the shift has change relative to the known shift at atmospheric pressure, as we had anticipated. Also as expected, NMR measurements find no evidence of field-induced magnetic order at this pressure and at temperatures above 2 K. These preliminary experiments set the stage for an extension of these measurements to much lower temperatures (50 mK) and in fields to 12 T.

During the course of this project, collaborators found evidence for two magnetic quantum critical points in CeRhIn₅ induced by magnetic fields of 35 and 50 T at atmospheric pressure. An interpretation of those discoveries requires assumptions about the nature of the magnetic order at these fields. Because NMR can detect the nature of the magnetic order, proposals were submitted to the National High Magnetic Field Laboratory in Tallahassee for NMR measurements to 30 T and at temperatures to as low as 300 mK. Those proposals were accepted and we carried out the proposed experiments under these very demanding conditions. The important preliminary conclusion is that a field of 30 T does not change the magnetic structure, but the ordered magnetic moment appears to have decreased by about 25 %. This result is consistent with the proposed interpretations of field-induced quantum critical states in CeRhIn₅.

U₂PtC₂

U₂PtC₂ has been known for nearly 30 years to be a superconductor below about 1.5K but the nature of the superconductivity has never been studied. Several NMR and Knight shift measurements were made on U₂PtC₂ at temperatures to 50 mK with the surprising conclusion that the superconductivity is highly unusual in which superconducting electrons form with parallel spin alignment. Additionally, analysis of the Knight shift shows that this superconductivity develops out of a state in which ferromagnetic correlations are particularly strong, raising the possibility that U₂PtC₂ is close to a ferromagnetic quantum critical point.

PuRhIn₅

PuRhIn₅ has exactly the same crystal structure as CeRhIn₅, but instead of ordering antiferromagnetically like CeRhIn₅ at atmospheric pressure, it is superconducting near 1.5 K. Our NMR experiments on PuRhIn₅ show that its superconductivity also is unconventional, so called d-wave with zero net spin but finite orbital moment of superconducting electrons. The NMR relaxation rate above the superconducting transition temperature is consistent with proximity of PuRhIn₅ to an antiferromagnetic quantum critical point. Indeed, similar measurements made on a sample in which a small number of In atoms are replaced by Cd find that superconductivity is replaced with antiferromagnetic order.

Future Work

Nuclear magnetic resonance (NMR) techniques will be used to search for field-induced magnetic order and its quantum critical point in the pressure-induced superconducting phase of CeRhIn₅. These measurements will be performed at simultaneous extremes of pressures to 2 GPa, magnetic fields to 12 T and temperatures to 50 mK. To help interpret these experiments, measurements will be made with the applied field parallel and perpendicular to the tetragonal c-axis of these crystals. The compound CeRhIn₅ is an excellent example of a system whose magnetic transition can be tuned by pressure to zero temperature and will be used as a prototype for testing theoretical models of the signatures for and consequences of quantum fluctuations for the formation of electronic states from them.

Conclusion

This project addresses the fundamental, unanswered question of what happens when a magnetic transition is tuned to absolute zero temperature. One possibility is that quantum fluctuations of the magnetic order at zero temperature produce an attractive interaction that creates an unconventional form of superconductivity or that these fluctuations induce some new, unanticipated quantum state. Success in this project will make significant strides in advancing our understanding of the consequences of quantum fluctuations that arise out of a zero-temperature magnetic transition..

Publications

Mounce, A. M., H. Yasuoka, G. Koutroulakis, N. Ni, E. D. Bauer, F. Ronning, and J. D. Thompson. Evidence for spin-triplet superconductivity in U₂PtC₂ from ¹⁹⁵Pt NMR. *Physical Review Letters*.

Materials for the Future

Postdoctoral Research and Development
Continuing Project

Electronic and Photonic Transport in Chiral Materials and Nanostructures

Diego A. Dalvit
20130781PRD1

Introduction

Graphene and topological insulators are the most recent discoveries in material science, and represent the cutting edge of condensed matter physics. Among many applications, these materials are the most promising candidates to replace semiconductors in commercial electronics. They will make possible, for example, the creation of a microprocessor with orders of magnitude higher speed and almost no energy loss. Spin-orbit coupling in these systems represent a form of chirality, which is a property prevalent in nature. The study of the electronic and photonic chiral materials offers exciting opportunities for discovering interesting new physics and technologically important applications, including spintronics-based information processing, new material probe techniques, and Casimir force repulsion.

Benefit to National Security Missions

This project will impact LANL/DOE mission in basic energy sciences, materials, and nanotechnology, as it will develop new theoretical and numerical tools to describe some of the most exciting materials in condensed matter physics, including graphene, topological insulators, and topological superconductors. It also has the potential of attracting interest from external agencies, such as DARPA, that have shown recent interest in controlling Casimir forces and in energy harvesting.

Progress

Since Dr. Tse became a Director's postdoctoral fellow (almost a year ago), he accomplished the following:

He studied spin dynamics and spin noise in 2D Dirac materials including transition metal dichalcogenides. He formulated the first rigorous theory for spin noise as observed from Faraday rotation and discovered the emergence of valley noise that uniquely arose from the new valley degrees of freedom. Together with Drs. Sinitsyn, Saxena and Smith (T-4), he wrote a paper which is under review in Physical Review Letters. This work also result-

ing in a new collaboration with the experimental group of Dr. Crooker (MPA) to measure the predicted spin and valley noise in 2D Dirac materials.

He studied near-field radiative heat transfer between 2D Dirac materials, including topological insulators and Chern insulators. This is work in progress with Dr. Dalvit, and a paper is being written for journal submission.

He studied the renormalization of optical properties and plasmon properties in multilayer graphene systems. Due to electron-electron Coulomb interaction based on the quantum kinetic equation, he had to take into account both the band-renormalization and excitonic effects on an equal footing. A paper is being written for journal submission. He developed a theory of excitons in 2D transition metal dichalcogenides using the quantum kinetic equation approach. This theory allows investigation of the effects of geometric Berry phases and their related topological effects on the exciton properties in these new materials. Work is in the final stage and an article will be written for publication.

He started to study the Coulomb drag between graphene sheets in the A.C. regime. He is formulating a theory for this problem based on the diagrammatic many-body perturbation formalism which will be used to study the A.C. Coulomb drag between graphene sheets. Work is in progress and preliminary collaborative effort has been established with Prof. Antti-Pekka Jauho (Technical University of Denmark), who is an expert in the field of Coulomb drag. He also has initiated a collaboration with Prof. MacDonald (UT Austin) on the D.C. Coulomb drag between graphene sheets in the quantum Hall regime. Preliminary results have been obtained and a draft of the manuscript for this work has been developed.

He also has an ongoing collaboration with Prof. Armitage from the Johns Hopkins University to understand the Faraday rotation experiments in topological insulators Bi₂Se₃. He is formulating a transport theory for these

materials to understand the effects of magnetic fields on the electron-impurity scattering rates in the topological insulator surface states.

In addition to the above research activities, he has also delivered four talks:

- Contributed talk on “Spin and valley noise in Dirac Materials” at the 2014 APS March Meeting
- Invited talk on “Spintronics with Dirac electrons” at the New York City College of Technology
- Invited seminar on “Magneto-optical and Magneto-electric Effects in Topological Insulators” at CINT
- Invited seminar on “Many-body renormalization in Dirac Electronic Systems: Optical Properties” at T-4 BLABS

He has contributed to the writing of two LDRD proposals that are currently under review.

Future Work

During year 2015, Dr. Wang-Kong Tse will focus his research on the theory of collective optoelectronic effects in Dirac semiconductors and graphene. In collaboration with Dr. Diego Dalvit (T-4) and Dr. Nikolai Sinitsyn (T-4), he will explore magneto-plasmonic modes in graphene in the presence of a moderate magnetic field. The goal is to build the theory of collective states of Dirac electrons that emerge due to the synchronizing effect of a microwave field applied in resonance with Landau levels. We expect that such states in graphene will realize a new way to control a large number of quantum two-state systems (qubits) in solid state by purely optical means. In particular, we will explore the possibility of realizing quantum gates and observe a long sought superradiance phase transition. This specific goal will require theory whose range of applications will extend to many other phenomena in Dirac materials, in particular, the chirality effects on plasmon modes in massive Dirac Bloch bands.

An additional goal for FY15 is the study of geometric phase effects on excitons in Dirac semiconductors. Excitons are optically created quasiparticles made of coupled electrons and holes. They are used for energy harvesting in solar energy applications. Due to unusual physics of Dirac electrons, these quasiparticles are expected to show new types of response to external electric and magnetic fields. Dr. Tse will estimate the possibility to observe such properties of Dirac excitons with LANL capabilities in high magnetic fields and optical spectroscopy.

He will also investigate the connection between quantum friction and Coulomb drag, develop a theory of AC Coulomb drag, and propose experiments to observe this phenomenon.

Conclusion

The expected results of this project is a comprehensive study of the transport properties of strongly spin-orbit coupled materials including topological insulators and superconductors, as well as nanostructures built from chiral materials such as graphene superlattices. Specifically, we will study how density-density and current-current correlation functions depends on the spin-orbit coupling, external magnetic fields, and electron-electron interactions. We will also perform research on the optical properties of chiral materials with the intention to elucidate how electromagnetic fluctuation-induced (Casimir) forces depend on the physical parameters of such systems, with the ultimate goal of determining optimal strategies for controlling the Casimir effect.

Publications

Lopez, P. Rodriguez, W. K. Tse, and D. A. R. Dalvit. Radiate Heat Transfer in 2D Dirac Materials. *Journal of Physics: Condensed Matter*.

Tse, W. K., A. Saxena, D. L. Smith, and N. A. Sinitsyn. Spin and Valley Noise in Two-Dimensional Dirac Materials. 2014. *Physical Review Letters*. 113: 046602.

Efficient Carbon Nanotube Growth on Graphene-Metal Surfaces

Stephen K. Doorn
20130785PRD2

Introduction

The project goal is to optimize the synthesis conditions that promote the catalytic conversion of graphene into high yield few-walled (1-2 layers) carbon nanotubes (CNTs). The approach will overcome typical drawbacks of nanotube synthesis that include use of harsh chemical treatments of growth substrates and include the need for multi-step purification processes. These challenges will be overcome by using graphene sheets as an innovative new substrate for growth that allows one-step synthesis of composite materials. Growth can also be attained at low-temperatures (~200 degrees C vs the typical 800 degrees or higher) which is essential for enabling development of composites based on multiple materials with very different ranges of temperature compatibility. Another innovative aspect is to use dip-pen lithography capability for fine-control over placement and morphologies of metallic nanoparticle growth catalysts. Optimization of our growth processes will require variation and study of the influence of multiple growth parameters. These will include modulation of catalyst particle size, composition, and placement. We will also study the effects of variable temperatures and reactant gas composition and flow rates. The resultant synthesis will directly provide nanotube/graphene composites that will be studied for their energy harvesting and storage potential. Low temperature growth processes are anticipated to also allow the use of gold nanoparticles for growth as well, which will be the key to enabling development of nanotube-nanowire hybrids (not yet attained) of interest for optical and electronics needs. The knowledge gained in these first synthesis directions will also allow us to tailor synthesis conditions to pursue growth of other novel composite materials including carbon nanotube hybrids with complex metal oxides. Such oxide thin films form the basis for superconducting and multi-ferroic materials of technological interest. Interactions with nanoelectronic materials such as nanotubes can introduce emergent electronic behaviors that may enhance the properties of interest.

Benefit to National Security Missions

The work is directly relevant to DOE Office of Science interests in the fundamental science of and development of multifunctional nanoscale materials. The work will also probe the fundamentals of carbon nanomaterial interactions with other materials, also of interest to DOE/SC. The nanotube/graphene materials are of significant interest for energy storage and energy harvesting, giving the work mission relevance for both energy security and the environment (climate and energy impacts). The effort is also directly related to development and basic understanding of nanomaterials with ultimate impact on electronics, sensing, and imaging needs as well.

Progress

Efforts in the past year have focused primarily on project aspects associated with graphene generation and utilization and progress towards heterostructure development.

Chemical vapor deposition (CVD) capability for carbon nanomaterial growth

The CVD system for synthesis of carbon nano-materials was completely set up, is functioning, and related safety documentation (IWDs) are in place and updated.

Optimize the large area graphene growth and transfer process

Our approach for synthesizing high purity large area graphene on Cu foil using methane as the hydrocarbon source has been established. This flexible technique allows for graphene to be transferred onto virtually any substrate. We are characterizing the morphological properties of the graphene using optical spectroscopy and scanning electron microscopy. Raman spectroscopy is also used to determine the number of graphene layers present on the substrate. The challenge was to transfer large area graphene with minimal defects and completely dissolve the Cu foil. Various etching agents and heating treatments were explored to optimize the transfer process.

The large area graphene samples were also prepared for Han Htoon's group for a collaborative project on the interaction between quantum dots and graphene surfaces. Graphene was transferred on glass and Si wafers prior to the spectroscopy/microscopy studies. Unique interactions with quantum dots are shown to establish localized charging of the graphene surface that introduces a plasmon response in the visible spectral region that then couples with the quantum dots to alter light emission properties. The work has resulted in a manuscript submitted for publication.

Large area graphene samples were also provided for a collaborative project with professor Alexandru Biris (University of Arkansas at Little Rock) on graphene-based multiplex approaches for detection of circulating tumor cell detection in blood.

Development of graphene-nanowire hetero-structures

This is a collaborative project with Jinkyong Yoo. The aim of this work is to develop hetero-structures (graphene-coated nanowires) for lithium battery applications. A direct synthesis of graphene on the nanowires could be a potential approach to overcome the problem of volume expansion of nanowires that limits their useful lifetime in these applications. We have already demonstrated the deposition of the graphitic material on Ge nanowires. However, we would like to develop graphene encapsulated Si nanowires, since Si is less expensive and preferred over Ge. We have generated encouraging preliminary results that demonstrate for the first time the ability to grow a graphene-like coating on Si-nanowires. The result will be the subject of a patent application.

Synthesis of graphene nano-discs

The goal of this project is to synthesize nano-graphene structures and understand their optical properties. Nano-graphene discs with lateral dimensions between 30-200 nm were synthesized via chemical vapor deposition. We have shown the size and morphology of these nano-materials can be controlled by varying the synthesis conditions. The purified structures were functionalized with carboxylic groups via acid treatment and characterized by various microscopy and spectroscopy techniques. Surprisingly, strong absorbance features in the near-infrared spectral region have been observed for the first time in such nanographene materials. We are working with a theory collaboration to understand the origins of these novel optical behaviors and how they depend on surface chemical functionality.

This work was presented at the Graphene 2014 international conference (May 6-9, Toulouse France): "Synthesis of graphitic nano-discs with unique optical properties" by E.

Dervishi, Z. Ji, K. A. Velizhanin, C. Sheehan, M. Sykora, and S. K. Doorn.

Collaboration project with Vojtech Svoboda from Binery Scientific, Inc.

The aim of this project is to modify glassy carbon substrates using different carbon nano-structures (graphene, nano-graphene and carbon nanotubes) towards enhancing electron transfer from bound enzymes to the conductive electrode for biosensors. Deposition of graphene and nanographenes has been accomplished.

Future Work

Encouraging results on generating graphene/nanowire heterostructures and their potential high impact in energy storage applications makes them a focal point of future work. Additionally, there is significant potential for unique behaviors to arise from graphene interactions in complex oxide heterostructure interactions, making this area another focal point.

Graphene-nanowire hetero-structures

Our Ge-graphene nanowires will test systems for study of ionic transport and mechanical dynamics associated with electrochemical cycling as Si development proceeds in parallel. In-situ transmission electron microscopy (TEM), Raman, and electrochemical measurements will be applied to understand lithiation behavior and reaction chemistries to probe the role of graphene in overall anode performance. For the development of graphene/Si nanowire heterostructures we will explore different catalyst systems (e.g. Au nanoparticles or sacrificial thin film metal coatings deposited on the nanowires) paired with various nanowire morphological aspects (single crystalline vs. polycrystalline structure) for efficient hydrocarbon decomposition, carbon rearrangement and crystalline, large-area graphene sheet nucleation. Studies of the full parameter space will provide an understanding of heterostructure growth mechanisms and lead to optimized growth.

Complex oxide/ carbon nanomaterial heterostructures

We will establish heterostructures by combining ferro-electric and ferro-magnetic wide band semiconductors with graphene. The goal is to exploit the properties of both graphene and complex oxides and develop hybrid structures for device applications. Depending on the oxide properties, we will either deposit their thin films (with varied thickness or geometries) on graphene sheets or use them as a starting layer for the hybrid device. One of the first oxides to explore is ZnO. ZnO has unique electronic/optical properties, low cost, and shows promise in supercapacitor, sensor and thin-film transistor, applications.

Additional efforts will be applied in continuing the large

area graphene synthesis efforts to support external collaborations and growth of suspended small-diameter carbon nanotubes over void spaces for optical studies.

Conclusion

The primary technical goal is to develop novel synthesis approaches to improve the optical and electronic properties of few-walled (targeting 1-2 layers) carbon nanotubes. The methods we anticipate using will also result in generation of functional hybrid carbon nanomaterials of interest for energy storage, electronic, and multi-ferroic applications. These may include hybrid nanotube/graphene materials, nanotube/nanowire heterojunctions, and nanotube composites with complex oxide thin films.

Publications

Gao, Y., O. Roslyak, E. Dervishi, N. S. Karan, Y. Ghosh, C. J. Sheehan, F. Wang, G. Gupta, A. Mohite, A. M. Dattelbaum, S. K. Doorn, J. A. Hollingsworth, A. Piryatinski, and H. Htoon. Enhancing biexciton emission efficiency of giant nanocrystal quantum dots with graphene. To appear in *Advanced Optical Materials*.

Alternating Positive-Negative Charge Systems: New Compounds and Synthetic Routes

David E. Chavez
20130788PRD2

Introduction

This project will focus on the development of alternating charge molecules for energetic materials applications. These alternating charge molecules are predicted to have very promising energetic material performance properties, and may have very interesting safety properties. There is a paucity of examples of these types of materials described in the literature, and therefore the basic scientific understanding and principles for synthesizing these materials are necessary. The materials will be very challenging to construct, however, due to their predicted performance properties, there is high potential for opening up a new area of research in the area of energetic materials.

Benefit to National Security Missions

The project focuses on the development of novel energetic materials with unprecedented performance, and potentially, safety. This topic is directly relevant to NNSA defense programs, science campaign 2 and to the DoD. Because the project will develop a fundamental understanding of the proposed materials, it will have a direct impact on expanding fundamental chemistry concepts.

Progress

In the past several months of the project, the postdoc was able to synthesize a key synthetic precursor to a tetrazine oxide target molecule. The postdoc has prepared and characterized the first energetic N-amino-N-oxide-1,2,3-triazole, by two routes that open this class of materials to synthesis from 1-amino-1,2,3-triazoles by hypofluorous acid oxidation, or from the amination of 1-(benzyloxy)-1,2,3-triazoles followed by debenylation. The unique energetic material 1-amino-1,2,3-triazole-3-oxide (DPX2) possesses no undo sensitivities towards impact, friction, or thermal stimuli, indicating the potential utility as a general strategy in energetics design. The two different synthetic routes to the precursor molecule developed required 3 steps in one case, while the other

pathway consisted of four synthetic steps.

Subsequently, the student has prepared 1,2,3,4-tetrazine-1-oxide, the first non-benzoannulated member of this class of compounds, via a reaction that has not been utilized previously to reach this class of compounds. The molecule appears to be relatively unstable.

Future Work

The project will continue with efforts toward the synthesis of novel tetrazine dioxides. The chemistry and synthetic routes to these materials will continue as progress has already been made in synthesizing derivatives of the target materials. Optimization of the synthesis pathways will be a part of the studies for the second year as will discerning new synthetic pathways.

The tasks for the second year include:

- Optimization of the synthetic schemes developed in year 1.
- Proposal of new synthetic pathways toward the target materials.
- Attempt the synthesis of the target molecules using the new synthetic pathways.
- Characterize the synthesized molecules.
- Publish a journal article on the results of the studies.

Conclusion

While the high thermal stability of APNC systems is known, little is known about their mechanical sensitivities and the other molecular features affecting same. A fundamental understanding of these properties must be developed in order to design explosives of high performance and stability. The potentially unprecedented energetic performances of compounds of these types would lead to revolutionary effects in energetic systems as a result of higher energetic yields from smaller-sized devices, as well as new fundamental insights into factors

affecting molecular stability.

Publications

Chavez, D. E., D. G. Piercey, S. Hemisch, C. Kirst, T. M. Klapoetke, and J. Stierstorfer. An energetic N-oxide and N-amino heterocycle and its transformation to 1,2,3,4-tetrazine-1-oxide. To appear in *Propellants, Explosives, Pyrotechnics*.

Chavez, D. E., T. M. Klapoetke, D. A. Parrish, D. G. Piercey, and J. Stierstorfer. The synthesis and energetic properties of 3,4-bis(2,2,2-trinitroethylamino)furazan. To appear in *Propellants, Explosives, Pyrotechnics*.

Graphene Quantum Dots for Carrier-Multiplication-Enhanced Solar Cells

Victor I. Klimov
20130790PRD2

Introduction

Quantum dots (QDs) are nanometer-sized crystals of semiconductors that offer many unique optical and electronic properties of great interest for use in solar cells. One such property is high-efficiency carrier multiplication (CM) whereby absorption of a single photon produces multiple electron-hole pairs, potentially increasing the current produced in solar cells. To date, the measured efficiencies of CM in inorganic QDs are not high enough to impact the power output of real devices. In this project, we will explore the potential of graphene-based nanomaterials. Graphene is a very strong absorber of light, and is highly conductive.

Furthermore, recent theoretical calculations have shown that CM yields in graphene can greatly exceed those in inorganic solids. However, ordinary graphene cannot serve as an absorber in a solar cell, because it is a “semimetal” that has no band gap, which means it cannot produce a voltage in a device. It is possible to open the band gap by introducing confinement effects similar to those found in inorganic QDs, by making nanometer-sized graphene pieces, or graphene-QDs. Although the production of ordinary graphene is a rapidly developing field, the exploration of graphene-QDs is in its relative infancy. Our effort will start with existing techniques for making graphene, and modify them for the production of graphene-QDs, which will allow us to perform the first high-level spectroscopic studies of these unique materials, including especially the first measurements of CM efficiencies. Correlating CM yields with the structure of the graphene-QDs will allow us to optimize the material by further modifying the growth conditions, with the goal of approaching the theoretically predicted record efficiencies. This project will also study QDs made of other 2D semiconductors structurally related to graphene. Finally, we will explore the application of these materials in proof-of-principle PV devices.

Benefit to National Security Missions

This work is a fundamental study of a relatively new material class that has been predicted to have properties of great relevance to optoelectronic devices in general, and solar cells in particular. Specifically, we will produce and study nanometer-sized pieces of graphene. Graphene is a form of carbon consisting of individual sheets of graphitic carbon. Interest in graphene for use in electronic devices has exploded over the past decade, but studies of nano-graphene pieces, or graphene quantum dots (in which the effects of quantum-confinement will produce very different properties) are still only at the starting point. Our focus will be on studying and optimizing those properties of nano-graphene of direct relevance to applications in solar energy capture and energy efficient solid-state lighting. In this way, our work is directly tied to the LANL Science Mission in the Basic Understanding of Materials, and in the process will involve exploration of Fundamental Chemistry. As the work progresses into producing graphene devices, it will directly add to progress in the LANL Energy Security Mission, particularly in the area of Renewable Energy. As such, it will be of primary interest to various offices within DOE, including especially the Office of Science. It can also be anticipated that research into combining nano-graphene with other types of quantum dots will lead to new phenomena of relevance to other types of devices, including in biosensing and radiation detection. Thus, there may be long-term benefits to LANL efforts and eventually to federal funding agencies in these areas.

Progress

As per expectations, Oppenheimer Fellow Dr. Shaojun Guo joined our team at the beginning of July of last year. During his initial period of training (which was, as typical, roughly 1.5 months) Dr. Guo worked very hard to make sure that our laboratory was properly outfitted for the planned activities. This project revolves primarily around making nano-sized pieces of graphene, small enough to allow the effects of quantum-confinement to

induce a band gap into this nominally metallic material. Since we have never previously worked with graphene, it was expected that it would take some effort to transition our facilities for this new activity. To a large extent, he was able to use the glassware typical of our other chemistry efforts, and was able to acquire the few exceptions within a relatively short period of time. Indeed, one of the attractive aspects of this material and the method Dr. Guo has chosen to make it is its relative simplicity in terms of equipment. Thus, near the end of summer, he was already beginning to develop his approach to making graphene quantum dots (QDs).

In the Fall of 2013, Dr. Guo had produced nano-sized pieces of graphene, which as a signature of quantum confinement, exhibit emission at blue wavelengths. Initial studies of these materials showed relatively complex transient spectroscopic features, which suggested that further improvements in size-dispersity were needed before conclusive studies of the fundamental properties could be performed.

As this work continued through the remainder of the project year, Dr. Guo also expanded the project into production of nano-sized pieces of other semiconductors that, like graphene, also possess a two-dimensional “layered” structure. These include a range of chalcogenides, including sulfides, selenides and tellurides of molybdenum, tungsten, indium and tin. Characterization of these materials is still at a very basic level, but so far, a consistent uncertainty particularly with the molybdenum-based particles is the effect of the chosen method for “exfoliating” the bulk parent material. More specifically, when this process (which separates the individual layers of material that are weakly bound in the bulk solid) is done with the assistance of lithium, it has proven non-trivial to completely remove all the lithium ions, which has an unknown effect on the properties of the material.

As of yet, no evaluation has been performed on these materials regarding their “carrier multiplication” properties. Correct measurement of this phenomenon, in which high-energy photons produce more than one electron-hole pair per photon, requires detailed understanding of the basic dynamical optical properties of a given material, so the inconsistencies in the material must be alleviated first. Meanwhile, though, several of these materials are being studied via a new time-resolved photocurrent measurement technique to look for evidence of high yields of carriers generated through photon absorption.

These studies were only started in early June of this year, so there are no conclusions to be reported at this time.

Future Work

Oppenheimer Fellow, Dr. Shaojun Guo, was hired in July 2013, so the next project year begins roughly one month from now. Based on the successful production of quantum dots (QDs) based on both graphene and other two-dimensional semiconductors (including a range of transition metal sulfides and selenides), the second year will start with a focus on in-depth optical and structural characterization of these materials. This will be the principle activity of the first two quarters of the year, through the early parts of calendar year 2015. Specifically, we will be establishing the correlation between structure of these QDs, as determined by transmission electron microscopy and elemental analysis, and their static and transient optical properties, which will be probed using a range of tools available within the Nanotechnology and Advanced Spectroscopy Team (in C-PCS). Of particular interest are device-relevant phenomena such as non-radiative Auger recombination, which is a source of energy loss in both light-emitting diodes and solar cells, and carrier multiplication, a phenomenon that can convert the extra energy of ultraviolet photons into additional current in a solar cell. Within the latter part of the year, it is expected that the most interesting materials will be included in prototype devices for the evaluation of their transport properties (i.e., their ability to be used in devices that rely on the conduction of charges in, out and among the QDs). This is the first step in their use as the active material in real photovoltaic devices.

Conclusion

We will adapt existing graphene fabrication techniques to produce high-quality graphene quantum dots. We will then perform high-level spectroscopic study of these materials, including the first measurements of graphene-based “carrier multiplication” (CM), a phenomenon known in other quantum dots in which a single photon produces more than one electron-hole pair. While optimizing our graphene synthesis conditions, we will expand our studies to include synthesis and characterization of quantum dots of other two-dimensional semiconductors. Finally, we will fabricate “proof-of-principle” solar cells based on these materials to examine whether CM can impact the power output of real devices, a potentially field-changing question.

Microstructured Biohybrid Synthesis of Photosynthetic Assemblies

Gabriel A. Montano
20130796PRD2

Introduction

Photosynthesis ubiquitously occurs in membranes. These lipid bilayers can be among the most crowded interfaces in nature with up to ~70% of the total available area occupied by proteins. Further, the effective concentration of photosynthetic pigments can be as high as 1 molar. Despite this, photosynthetic charge separation proceeds with unprecedented quantum efficiencies that approach unity due to a high level of two- and three-dimensional organization. The energetics of the reaction is sufficient to oxidize water and drive cellular processes that ultimately reduce CO₂ into carbohydrates. How do these organisms capture the energy of light with such high efficiencies but more importantly, how can the design principles be exploited? While the former question has been investigated over the past decades, the latter has been relatively unexplored.

Utilizing soft materials capabilities developed by our team along with micro- and nano-patterning technologies at the Center for Integrated Nanotechnology (CINT) we will investigate programmed organization of photosynthetic assemblies into two- and three-dimensional assemblies. We will investigate parameters effecting biohybrid assembly such as packing density, distance and orientation of light-harvesting (LH) and reaction center (RC) complexes and optimize the biophysical phenomena of energy transfer and charge separation in robust, long-life assemblies.

The ability to intricately organize and design biohybrid photosynthetic systems would have transformative impact across multiple fields. In the proposed research, controlled assembly of photosynthetic complexes would allow for more efficient light harvesting into the system while also elucidating the spatial parameters required for optimal assembly functionality. Lastly, the approaches described here can be extended to any variety of biomolecule (other proteins, DNA etc.) opening up additional applications in bio-sensors, bio-materials, and research

platforms.

Benefit to National Security Missions

The work to be performed directly addresses needs within DOE and energy-related efforts and fundamental biomaterials research design. Success of the proposed work will result in necessary information in order to develop a new class of energetic materials capable of achieving a long-standing goal: harnessing the energy of the sun with the efficiency of natural photosynthetic assemblies and the stability of standard photovoltaics. Secondly, optimizing the bio/synthetic interface will have an impact far beyond energy science effecting arenas such as bio/chemical materials development and detection, sensor and prosthetic development and environmental remediation. Thus, the proposed research will generate opportunities within the confines of DOE as well as provide avenues for development within agencies such as DOD, IC, NIH and potentially more.

Progress

Research to date has focused on the design of artificial light-harvesting complexes that mimic two different classes of light-harvesting antenna found in nature and described below. Both examples of generated systems represent important advances in the design of artificial photosynthetic systems and will be utilized to generate multi-component, bio-inspired, and bio-hybrid photosynthetic arrays.

Polymeric supramolecular light-harvesting nanocomposites: This area of research has focused on the design of artificial light-harvesting assemblies inspired by membrane bound assemblies found in archaic bacteria (ie. purple bacteria). In natural systems, membrane proteins in a lipid membrane are utilized to coordinate bacteriochlorophyll (bchl) molecules in concise configurations that result in high-efficiency light-harvesting and energy transfer. While such a design is highly efficient, it is not optimal in materials design where such coordinated

strategies can be laborious and result in labile materials that are static in nature. Thus, the approach utilized in this study uses amphiphilic block-copolymers to provide a membrane environment in which it is possible to organize in a non-covalent fashion cofactors capable of performing efficient light-harvesting and energy transfer. Such a strategy has multiple advantages to the biological approach: polymers provide added stability over lipid membranes; polymers are tunable and responsive; results in non-covalent/coordinated assembly conducive to scalable materials design. Aaron Collins has validated this approach generating polymeric nanocomposites consisting of two separate chromophores capable of efficient light-harvesting and energy transfer. Further, he has demonstrated that it is possible to make polymeric films from the bulk solution based nanocomposites that exhibit enhanced energy transfer efficiency (>95%) indicating the versatility of the polymer materials approach. Such rates rival natural photosynthetic antenna.

Artificial Polymeric Chlorosomes: This area of research has focused on generating supramolecular light-harvesting complexes using polymers and chromophores as building blocks and mimicking the natural chlorosome antenna of green photosynthetic bacteria. The chlorosome antenna is unique within photosynthesis in that it utilizes pigment self-assembly instead of protein-pigment. Thus, it has naturally been of interest to the biomaterials community in that it utilizes an assembly strategy conducive to materials design. Chlorosomes are composed of a lipid that naturally form monolayers instead of bilayers, creating a hydrophobic pocket in which the pigments are allowed to undergo their self-assembly. As such, chlorosomes can consist of tens of thousands of pigments within the hydrophobic pocket and result in structures of ~100-200 x 50 x 20 nm in size, oblong cigar shaped structures, quite large for biological photosynthetic antenna. In nature, such a large structure packed with pigments is useful for the native bacteria which tend to grow in areas in which few photons of light reach and thus it is critical that each photon is absorbed.

In our design, Aaron has generated artificial chlorosomes using block-copolymers that are natural micelle forming polymers to induce formation of a similar hydrophobic pocket in which bchl c is allowed to self-assemble. Remarkably, artificial chlorosomes generated also appear cigar-shaped indicating the bchl c self-assembly, is potentially solely responsible for chlorosome shape. While this point may seem trivial, it will be of great interest and surprise to the photosynthetic community. Further, Aaron has found that he is able to tune the size of the structures over an order of magnitude by addition of small amounts

of lipid. Also, the artificial chlorosomes have proven to be less permeable to some solvents than native chlorosomes and are currently being investigated for overall stability enhancements. Lastly, Aaron has demonstrated incorporation of multiple types of carotenoids that perform energy transfer to the bchl c molecules, similar to natural chlorosomes. Current work is focusing on including an energy transfer acceptor in the polymer membrane capable of receiving the photonic energy from the encapsulated pigments. This work is close to being written up waiting only on exhibited energy transfer to a feasible membrane acceptor.

Work thus far performed is consistent with the goals of the proposed research and represent novel approaches to generation of artificial photosynthetic materials. Future work will incorporate environmentally responsive block-copolymers that it is anticipated will result in responsive assemblies. It is our anticipation that both aspects of work will be published in high-impact journals and serve as components in multi-complex photosynthetic array design.

Future Work

Goals and tasks to be accomplished during FY15 include:

- Further development of artificial photosynthetic constructs
- Growth of green and purple bacteria for harvesting of individual photosynthetic components: requires initial cell culture growth, and isolation and purification of individual photosynthetic components
- Design of artificial LH/RC complexes using polymer/lipid and porphyrin based supramolecular assembly
- Development of initial 2D and 3D assemblies for characterization: requires demonstration of isolated photosynthetic assemblies and artificial photosynthetic assemblies into soft materials architectures
- Characterization of photosynthetic assemblies- i.e. stability, performance, communication (energy transfer, charge separation)
- Begin refinement of architectures to enhance stability/performance
- Begin expression and growth of modified LH

Conclusion

The specific aims of this project are to: 1) Genetically engineer photosynthetic proteins and potentially bio-inspired artificial photosynthetic constructs for programmed assembly onto functionalized and patterned 2D and 3D architec-

tures; 2) Investigate parameters effecting the optimization of biohybrid assembly e.g. packing density, distance and orientation of light-harvesting and reaction center photosynthetic complexes; and 3) Systematically explore and optimize the biophysical phenomena of energy transfer/charge transfer in assemblies using an iterative design strategy. Results will have a tremendous impact in artificial photosynthesis, energy applications, and biohybrid design.

Publications

Collins, A. M., G. A. Montano, Y. M. Tian, J. Duque, and T. Sahin. Block Copolymers for Responsive, Energetic Nanocomposite Membrane Assemblies. 2014. In 58th Annual Meeting of the Biophysical Society. (San Francisco, Feb. 15-19, 2014). , p. 420A. Cambridge, MA: Cell Press.

Materials for the Future

Postdoctoral Research and Development
Continuing Project

Topological Kondo Insulators

Joe D. Thompson
20130805PRD3

Introduction

Metals, like copper, conduct an electrical current easily because electrons are free to move; whereas, in an electrical insulator, like paper, there are no free electrons and insulators do not conduct electricity. Virtually all solid materials that we know are basically either metals or insulators. Recently, however, theory has predicted an entirely new type of material in which its interior is an electrical insulator (like paper) but its surface is a metal (like copper). Experiments have verified this prediction of a so-called topological insulator state where the metallic surface is 'protected' by rules of quantum mechanics. Because the topological insulator is so unusual, there has been an explosion of scientific research aimed at understanding conditions under which it can be studied and at imagining the technological implications of such a metal/insulator. So far, electrons in all known topological insulators are uncorrelated, that is, behave independently of other electrons that are present. Very recent theory has predicted that a new type of topological insulator might be possible in which the electrons are strongly correlated. If this theory of topological Kondo insulators were proven to be correct, it would open entirely new opportunities to understand and manipulate the remarkable properties of the inherently quantum mechanical topological state. The goal of this project is to test the validity of the predicted topological Kondo insulator state in the most promising material SmB₆ by using a specific set of measurements to separate the surface and interior contributions to the properties of this material. These experiments will involve the development of new techniques to measure the thermoelectric power as a function of pressure and to use very high magnetic fields to determine the microscopic configuration of surface electronic states. As a further test of theory, similar experiments will be performed on a related material SmS.

Benefit to National Security Missions

The discovery and understanding of new quantum states

of matter drive the frontier of materials physics and have the potential to open new routes to energy and security technologies for the Nation. This project explores and tests the theoretical proposal of a new quantum state, called a topological Kondo insulating state, that could lead to the additional discovery of exotic states of electrons that hold promise for new approaches to quantum computing and thermoelectric cooling.

Progress

The first year of this project focused on developing and optimizing experimental techniques that will be used to test the theoretical prediction of a topologically protected metallic surface state in Kondo insulators, such as SmB₆. Initial tests of low-temperature, high-pressure, high-magnetic field techniques to measure electrical resistivity and Hall effect used the newly discovered Kondo semi-metal CeNi₂As₂ as an example. These experiments led to the discovery of a new paradigm of a pressure-driven quantum-phase transition in the low carrier-density limit. A comparison of results of these measurements with a series isostructural metallic Kondo lattice compounds shows that carrier density plays an important role in approaching the quantum-phase transition and in establishing the strongly correlated electronic ground state, an important lesson applicable to interpreting planned high-pressure experiments on SmB₆. In particular, the low carrier density in CeNi₂As₂, which may be even more pronounced in topological Kondo insulators, could strongly influence the fundamental physics of materials such as SmB₆ by exhausting the number of charge carriers necessary to form a Kondo-derived bulk insulating state in SmB₆. This problem, called the Nozieres exhaustion problem, has not been considered in theoretical predictions of a topologically protected metallic surface state in SmB₆. A draft manuscript has been written that summarizes these results.

Studies also have begun on the topological Kondo insulator SmB₆. Motivated by the sensitivity of thermoelectric

transport to the topology of Fermi surface, measurements of the thermoelectric power and Nernst effect on the (110) surface of SmB₆ have been made at atmospheric pressure. These experiments show an unexpected difference between thermoelectric transport on the (110) surface and previously studied (100) surface. Initial measurements of the magnetic field dependence of the thermoelectric power at very low temperatures appear to find quantum oscillations, which are a measure of the microscopic electronic structure. If verified as quantum oscillations, these first of their kind measurements could provide an essential test of the topological nature of SmB₆.

Future Work

The proposed existence of a topologically protected metallic surface that surrounds a bulk insulating interior of electronically correlated materials will be studied through thermopower and Nernst-effect measurements as functions of temperature, magnetic field, and applied pressure. In the next fiscal year, we will test the reproducibility of possible quantum oscillations in the thermopower of SmB₆ discovered in the first year and use applied pressure to determine how the possible topological states in SmB₆ and related SmS evolve as their 'insulating' bulk energy gap is tuned by decreasing their crystallographic volume. Such first-of-their-kind experiments will provide critical tests of theoretical predictions and expose the intrinsic nature of electrons in these materials.

Conclusion

This research will explore the possibility of an entirely new quantum state of matter, the predicted topological Kondo insulator state. If the prediction is verified, this work will set a new direction for the study of correlated electron materials, an area of research for which Los Alamos is well-known, as well as lay the scientific foundation for new technologies, ranging from quantum computing to thermoelectric cooling devices.

Publications

Luo, Y., F. Ronning, N. Wakeham, X. Lu, T. Park, Z. A. Xu, and J. D. Thompson. Pressure- and field-tuned quantum criticality in the antiferromagnetic Kondo semi-metal CeNi₂As₂. *Physical Review Letters* .

Luo, Y., H. Chen, J. Dai, X. A. Xu, and J. D. Thompson. Heavy Dirac fermion or Dirac heavy fermion in a possible topological Kondo insulator?: Magneto-thermoelectric transport on the (011)-plane of SmB₆. *Physical Review Letters*.

Probing and Modifying Intertube Interactions in Semiconducting Carbon Nanotubes

Stephen K. Doorn
20130808PRD3

Introduction

The remarkable materials, electronic, and optical properties of single walled carbon nanotubes (SWNTs) make them promising elements for advances in optoelectronics and photonic applications. Many first applications will likely be in thin film networked architectures. The intertube interactions inherent to such devices ultimately will limit SWNT performance. It is therefore necessary to gain a better understanding and control of such interactions towards optimization of optical response. In this effort, double walled carbon nanotubes (DWNTs) will serve as well-defined model systems for understanding intertube interactions. This project seeks to answer the following questions: Can the inner tube of a DWNT emit photoluminescence? If not, can chemical functionalization of the outer wall switch on such emission (photoluminescence)? These questions will be addressed by performing photoluminescence spectroscopy at the single tube level and on samples highly enriched in DWNTs. Switching on emission via chemical functionalization will be pursued using low-level covalent oxygen and diazonium functionalization. We will also probe the nature of the electronic and mechanical coupling between the two concentric constituents of the DWNT. This last goal will use Raman spectroscopy as a probe (also at the ensemble and individual tube levels). Of particular interest will be probing of potential Raman interference effects arising from mechanical coupling of the two constituent walls. The results will provide the first in-depth understanding of electronic and mechanical coupling and interactions and place DWNTs as unique model systems for understanding intertube interactions in networked devices.

Benefit to National Security Missions

Results of this project will have a direct bearing on developing optical and electronic properties of carbon nanotubes for photonic and optoelectronics applications and may also contribute to sensing and spectral tagging applications. As a result, this work will have direct

relevance to the mission of the DOE-BES funded Center for Integrated Nanotechnologies (CINT) and the potential applications will be of interest to agencies including NIH, DOE, DHS, and DOD with potential impact on threat reduction and renewable energy missions. Our effort will also drive development and understanding of fundamental surface chemistry of low-dimensional materials supporting DOE goals for expanding fundamental understanding of functional nanomaterials.

Progress

The focus has been on the development of the ideal, all-semiconducting DWCNT samples for this study. As-synthesized DWCNT material, obtained from a collaboration with researchers from Shinshu University in Japan and Rice University in Texas, consists largely of DWCNTs of varying inner and outer-wall diameters mixed together with some SWCNT impurities. These SWCNTs have been suggested by some reports to be the source of the observation of optical emission in "DWCNT" samples. Even if one had DWCNT material consisting of 100% DWCNTs, the standard aqueous surfactant suspension method used to prepare dispersions of carbon nanotubes makes use of ultrasonication, which has been reported to produce some SWCNTs from DWCNTs by teasing out inner tubes out of DWCNTs. In order to make an unambiguous examination of the questions posed in the project description, we must be able to produce aqueous suspensions consisting of 100% DWCNTs.

To that end, we are using a recent breakthrough in nanotube separation science known as two-phase aqueous extraction (ATPE). Because nanotube synthesis cannot be controlled to a level that allows for the production of material with specific physical properties (diameter, chiral angle, electronic type), as-produced material is heterogeneous, requiring post-synthesis separation to produce highly pure, single species samples required for these measurements. The ATPE method relies on the partitioning of carbon nanotubes, suspended in a

mixture of surfactants, into two aqueous polymer phases of different hydrophobicity. The partitioning of the different nanotube species into the two polymer phases is controlled by the surfactant composition of the mixed micelles formed around the nanotube, effectively controlling the porosity of the nanotube surface with the aqueous environment and ultimately the hydrophobicity of the nanotube-surfactant complex. By tuning the surfactant composition with each cycle of extraction, separation of carbon nanotubes by diameter and electronic type has been achieved. We have produced two publications using the technique on SWCNTs over a diameter range 0.54-2.5 nm, which includes the diameters of both inner- and outer-wall constituent nanotubes within a DWCNT. This diameter-sorting ability should allow us to remove any SWCNT impurities inherently present in the DWCNT raw material or produced by the suspension process. Additionally, the electronic type modality allows us to sort DWCNTs by outer-wall electronic type producing 50% all-S-DWCNTs. This technique marries the abilities to produce samples of extremely high purity (single species), with high yield (both mass concentration and volume) and scalability.

Additionally, to modify the degree of interwall coupling between constituent nanotubes in a DWCNT, we will use chemical doping to modify the band structure of the outer-wall which should shift the electronic states under mild chemical functionalization conditions and completely destroy optical resonances under heavy functionalization. We have already demonstrated this tunable doping ability on SWCNTs using oxygen functionalization via the introduction of ozone and also with diazonium salts. Under mild conditions, SWCNTs were still able to emit while under more severe conditions, photoluminescence was quenched.

Future Work

We will use our developed (aqueous two phase) separation technique directly on the precious DWCNT material that we currently have with the goal of producing the all-S-DWCNTs necessary for this project. Starting with ensemble measurements first, we will perform photoluminescence excitation spectroscopy and resonant Raman spectroscopy to examine how the inter-tube interactions (ITIs) modify the optical states of the constituent tubes as compared to their SWCNT analogues. With such a highly pure, S-DWCNT sample, emission from DWCNTs should be possible to observe if present through PL measurements. Resonant Raman measurements should show how ITI affects the peak position and linewidth of the optical transitions, again as compared to SWCNTs. With such information in hand, we will then proceed with doping experiments using micro-PL and micro-Raman techniques to examine

how the outer-wall, highly polar functionalization surface modification changes the excited state relaxation pathways of the inner tube, possibly through site-specific energy transfer. If such a demonstration could be made, then this would open the door for tuning intertube interactions in nanotubes for optics applications and photovoltaics as well as provide critical understanding to the photophysics of carbon nanotube assemblies.

Conclusion

The goal is ultimately to understand intertube electronic interactions as modeled by double walled nanotube optical behavior. Understanding the nature of such interactions will have impact beyond basic interest in the nano-photonics/materials communities. Beyond understanding how excited electronic states relax into light emission in a coupled nanotube system, these measurements should reveal ways that chemical modification of intertube interactions can improve optical properties in nanotube aggregates. Such chemical routes will enhance their potential for applications such as energy harvesting, sensing, imaging, optoelectronics, and as novel photon sources which strongly match the strategic directions of the Lab's core missions.

Publications

- Duque, J. G., E. H. Haroz, J. Simpson, H. Telg, A. R. Height-Walker, X. Tu, M. Zheng, J. Kono, and S. K. Doorn. Asymmetric Raman excitation profiles and non-Condon effects in the resonance Raman response of armchair carbon nanotubes. To appear in *Physical Review B*.
- Fagan, J. A., C. Y. Khripin, C. A. S. Batista, J. R. Simpson, E. H. Haroz, A. R. H. Walker, and Zheng. Isolation of Specific Small-Diameter Single-Wall Carbon Nanotube Species via Aqueous Two-Phase Extraction. 2014. *ADVANCED MATERIALS*. 26 (18): 2800.
- Lim, , A. R. T. Nugraha, Cho, Noh, Yoon, Liu, Kim, Telg, E. H. Haroz, G. D. Sanders, Baik, Kataura, S. K. Doorn, C. J. Stanton, Saito, Kono, and Joo. Ultrafast Generation of Fundamental and Multiple-Order Phonon Excitations in Highly Enriched (6,5) Single-Wall Carbon Nanotubes. 2014. *NANO LETTERS*. 14 (3): 1426.
- Subbaiyan, N. K., Cambre, A. N. G. Parra-Vasquez, E. H. Haroz, S. K. Doorn, and J. G. Duque. Role of Surfactants and Salt in Aqueous Two-Phase Separation of Carbon Nanotubes toward Simple Chirality Isolation. 2014. *ACS NANO*. 8 (2): 1619.
- Telg, H., E. H. Haroz, J. G. Duque, J. Fagan, C. Khripin, X. Tu, M. Zheng, J. Kono, and S. K. Doorn. Diameter dependence of TO phonon frequencies and the Kohn anomaly in armchair single-wall carbon nanotubes. *Physical Review B*.

Materials for the Future

Postdoctoral Research and Development
Continuing Project

Understanding and Controlling Magnetism in Multiferroics with THz Pulses

Rohit P. Prasankumar
20130812PRD3

Introduction

In ferromagnets, the magnetization can be controlled with an external magnetic field, an idea widely used, for example, in magnetic data storage. However, magnetic fields have some drawbacks: there are limitations to how fast they can be switched, they are inconvenient to use, and they consume extra energy. Much effort has thus been devoted to multiferroic materials, in which electric and magnetic polarizations exist simultaneously and can be coupled, enabling control of magnetism with an electric field.

Recently, there have been significant advances in the ability to synthesize these materials, which has led to much effort focused on increasing the magnetoelectric (ME) coupling, especially near room temperature. However, the microscopic origin of this coupling can vary across different classes of materials, and is not well understood. Low energy excitations (i.e. soft modes, magnons, etc.) are thought to play a key role in ME coupling, and therefore also offer a promising route to controlling it.

Here, we will use ultrashort optical and terahertz (THz) pulses to shed light on the microscopic origin of magnetoelectric coupling in different multiferroic materials (building on our previous work in this area). In these experiments, we will use these pulses to separately manipulate and probe the magnetic and electric orders in a given material, enabling us to, e.g., modify the magnetic order and probe the resulting changes in ferroelectric order, or vice versa. This will provide much insight into magnetoelectric coupling in multiferroics, which should extend our knowledge of their basic physics and also enable researchers to optimize them for applications.

Benefit to National Security Missions

The proposed experiments will provide LANL, as well as CINT, with the capability to investigate magnetoelectric coupling in multiferroic materials through selectively

exciting the low-energy modes responsible for material functionality and probing their effects on this coupling. More generally, our effort to interface materials science with ultrafast terahertz (THz) and optical probes represents an essential element in the MaRIE strategy that connects the M4 facility to the Multi-Probe Diagnostic Hall. This work directly addresses the LDRD Grand Challenge in Materials, which underpins all three Laboratory mission areas. It also addresses several of the Grand Challenges for Basic Energy Sciences identified by the DOE Office of Science. We will work with the Program Director for Basic Energy Sciences to explore future funding opportunities within BES in the growing areas of ultrafast materials science.

Progress

The first step in this project was to build a high intensity source of femtosecond THz pulses. This was done by modifying an existing low-intensity THz setup to use a different generation crystal, with a tighter focus at the sample. The result is a very powerful tool for studying new materials, producing electric (E) fields of 100 kV/cm in single-cycle pulses centered at 1.5 THz, at sample temperatures between 2.5 and 500 K.

After testing and optimizing the setup, it was used to study the response of multiferroics. Rare earth manganese crystals were supplied by Sang-Wook Cheong at Rutgers University. These have magnetic dipole active antiferromagnetic resonances, or magnons, that overlap well with the generated THz spectrum. THz pulses provide both an ultrafast probe of the magnetization and a means of optically changing it. As a first experiment, 800 nm pulses were used to excite a HoMnO₃ crystal, after which the THz pulse monitored the sample's complex absorption. Optical-pump, THz-probe experiments almost always involve exciting electrons to the conduction band and probing their time-dependent transport. Surprisingly, in this case, no significant free carrier response was observed, and instead the pump induces changes in

the magnetism, which are directly seen as changes in the magnon absorption line. Specifically, the 800 nm pump energy excites d-electrons in Mn^{3+} , which relax by transferring energy to phonons. The excited phonons heat the crystal lattice slightly (probably <1 K, depending on the pump energy), which slightly reduces the magnetic order in the sample. This heating takes a few picoseconds to occur. This work will be submitted for publication in the near future. In our next experiments it will be interesting to directly excite the magnon, or similar resonances, like electromagnons in TbMnO_3 , and probe the resulting changes in the ferroelectric order through second harmonic generation. Such experiments will be more feasible after the laser system is upgraded to have higher power, which is expected to happen in September.

The same THz experimental setup is also being used, in parallel, to do nonlinear transport experiments in manganites, and in particular under conditions where the transport is “polaronic”, or dominated by electron-phonon coupling. In these experiments, the THz pulse acts as a “voltage supply”, rather than to resonantly excite low energy modes in the samples. LCMO thin films made by Quanxi Jia’s group in CINT are used for these experiments. Upon propagation through LCMO, the THz pulse accelerates the holes. The acceleration of these carriers generates another electric field. This field emitted by the sample can be measured, which is proportional to the current induced by the driving THz pulse. Because the THz electric field is quite large, the transport could be very different from what is known from optical experiments with weaker fields, and from conventional electronics measurements. Our initial experiments in this direction indicate that 100 kV/cm may be a large enough E-field to explore this new regime of transport in manganites.

Future Work

In the next fiscal year, we will initially focus on preparing our optical-pump, terahertz (THz)-probe results on HoMnO_3 for publication. This will happen while we wait for our laser system to be upgraded to higher power, which should happen before the start of FY15. Once the system is upgraded, we will optimize our high intensity THz pulses for pumping soft mode phonons in the canonical multiferroic material, BiFeO_3 , which has attracted much interest due to its room temperature coexistence of magnetic and ferroelectric (FE) order. In particular, we will explore THz pump, second harmonic generation probe experiments, which will allow us to directly measure how photoexciting the soft mode phonon is linked to FE order. We will then perform similar experiments on the manganite TbMnO_3 , which is well known for its strong magnetoelectric (ME) coupling, albeit at low temperatures. This material pos-

sesses an electromagnon resonance that is directly linked to ME coupling, and the proposed experiments should thus shed much light on these phenomena. We will also perform similar experiments on multiferroic heterostructures, consisting of thin FE and magnetic films grown on top of one another to maximize the coupling between them; we have extensively used optical pump-probe spectroscopy to study these heterostructures, and THz pumping should give more insight into ME coupling in these systems.

Finally, we will extend our initial experiments on THz transport in thin manganite films to explore the role of polarons vs. free carriers in transport, particularly under high driving fields. This is a new regime of transport in these extensively studied systems, which should reveal novel physical phenomena. Overall, the proposed experiments should thus provide much insight into ME coupling in multiferroics and transport in colossal magnetoresistance manganites, with wide ranging impact in physics and materials science.

Conclusion

Multiferroic materials, in which magnetic and ferroelectric order can be closely coupled, offer much promise for a variety of applications in data storage, novel logic elements, and sensing. However, the mechanisms underlying this coupling are not well understood, limiting the potential of these materials. Here, we will use ultrashort optical and terahertz (THz) pulses to shed light on the microscopic origin of magnetoelectric coupling in different multiferroic materials. This will provide much insight into magnetoelectric coupling in multiferroics, which should extend our knowledge of their basic physics and also enable researchers to optimize them for applications.

Broken Symmetries in Superconductors

Albert Migliori
20130813PRD4

Introduction

Broken symmetries lie at the heart of almost all modern physics problems — from the broken rotational and translational symmetries in magnets to the rather subtle gauge symmetry breaking in electro-weak theory (the Higgs mechanism) and superconductivity. Sometimes the symmetry breaking is known to exist, yet its form remains a mystery. Two good examples of this are the hidden-order in a uranium-based superconductor, and the pseudogap in high-temperature cuprate superconductors. Both problems are grand challenges in condensed-matter physics and both remain unresolved decades after their discovery. Resolution requires the development of new symmetry-sensitive probes. Preliminary measurements on plutonium and uranium-based superconductors have enabled unique access to all of the elastic moduli, important because only with a complete set can basic symmetry changes at the phase transitions can be understood. Such measurements have not been made on a high temperature superconductor. Also planned are transport measurements to explore the Fermi surface in yttrium barium copper oxide.

Benefit to National Security Missions

The basic science addresses a grand challenge in condensed-matter physics—that of understanding the mechanism of high temperature superconductivity. Since 1987, this mechanism remains elusive. Recent work by us has dramatically advanced our understanding, but more studies using extreme magnetic fields and uranium and plutonium superconductors is needed to proceed to a complete picture.

Progress

Measurements were completed on the very important plutonium gallium cobalt superconductor and a new electronic excitation seems to have been discovered that sheds important light on physical processes that are outside the range of applicability of conventional electronic

structure theory. The work has just been submitted to Nature.

Future Work

With our discovery of the pseudo gap as a thermodynamic phase in high temperatures superconductors, and the discovery of entropy sources in a plutonium superconductor that are outside the ability of electronic structure theory to understand, it is imperative that we determine the full elastic tensor of any high temperature superconductor through the superconducting transition, the pseudo gap transition, and in magnetic fields. In the first year, we have not succeeded in this because the very small detwinned single crystals we did measure were not in the geometric shape needed for such a determination. We cannot grow these crystals, but anticipate that they will be provided by the University of British Columbia.

We will also measure electronic transport in the yttrium barium copper oxide superconductors to explore the normal state transport properties with a goal to map the Fermi surface.

Conclusion

The work to date has already made important contributions to the understanding of the various phases of plutonium metal and alloys, uranium ruthenium 2 silicon 2 and plutonium cobalt gallium 5. Using 100 tesla magnetic fields, the measurements on the high temperature superconducting materials will be complemented by the very first measurements of the Fermi surface approaching the quantum critical point near optimal doping.

Publications

Grisonnanche, , Cyr-Choiniere, Laliberte, S. R. de Cotret, Juneau-Fecteau, Dufour-Beausejour, M. -. Delage, LeBoeuf, Chang, B. J. Ramshaw, D. A. Bonn, W. N. Hardy, Liang, Adachi, N. E. Hussey, Vignolle, Proust, Sutherland, Kraemer, J. -. Park, Graf, Doiron-Leyraud,

and Taillefer. Direct measurement of the upper critical field in cuprate superconductors. 2014. NATURE COMMUNICATIONS. 5.

Hybrid Metal-Semiconductor Nanostructures for Optimized Photosynthetic Algal Growth

Jennifer A. Hollingsworth
20130816PRD4

Introduction

Fuels derived from biomass are a promising source of energy. Cultivating aquatic microalgae in open ponds can generate large quantities of biomass, and recently, Sayre et al. showed a remarkable enhancement in algal growth inside hydrogel polymer beads. Further improvements in hydrogel-confined algae growth rely on efficient light utilization. Photosynthesis is facilitated by absorption of blue and red solar photons by chlorophyll, but green photons are transmitted. Our aim is to increase algal growth by “optically activating” the hydrogel beads with 1) fluorescent inorganic quantum dots (QDs) and 2) metal nanoparticles (MNPs) that exhibit surface plasmon resonance (SPR). These inclusions will color-shift incident sunlight to wavelengths useful for photosynthesis (UV to blue, green to red), and screen algal cells from damaging UV radiation.

The intrinsic properties of single-domain nanoparticles, including quantum dot (QD) fluorescence and metal nanoparticle (MNP) surface plasmon resonance (SPR), can be finely tuned by controlling the particle size and shape. Furthermore, the placement and connectivity of such functional units can give rise to synergistic “emergent” inter-particle interactions and properties. The proposed effort will take advantage of the postdoc’s previous work where he developed a synthetic framework for building multi-domain hybrid nanoparticles. The synthetic strategies will be applied here to target “by-design” architectures comprising hydrogel-QD-MNP composites with optimal optical properties. We will synthesize new QD and QD-MNP hybrid nanostructures with hierarchical structure and functionality. Metal coupling can result in either quenching or enhancement depending on the physical separation between the MNP and QD (too close results in fluorescence quenching, too far yields no coupling). Precise placement of QDs and MNPs remains an open synthetic challenge and will be the focus of this effort, e.g., heterotrimers, dot-in-cage structures, and dot-in-tube structures. Thus, impact will be in both

development of functional materials-by-design and in advancing our algal biofuels program.

Benefit to National Security Missions

DOE (basic and applied, EERE), DoD, NASA and NSF have all funded open or internal programs in algal biofuels, where NASA’s also aims to use the technology to treat waste water. DHS has reported on the potential impact that a successful biofuels program could have on addressing both national economic and environmental/energy security needs. Thus, it is now broadly recognized that algal biofuels development will be a key component in our future energy profile. To this end, our project aims to work with leading algal biofuels expert, R. Sayre (LANL B-11) in further enhancing the efficacy of algal production. We will establish novel materials strategies for optimizing light utilization by algae grown within a uniquely functional hydrogel matrix. In this way, the effort is wholly interdisciplinary, taking advantage of expertise in materials chemistry and bioscience at the interface between basic and applied energy science.

Progress

During the first 10 months of Matthew Buck’s tenure at LANL, he has made significant progress toward the synthetic research goals described in his proposal. To date, he has focused primarily on establishing a better understanding of the colloidal growth conditions that support fabrication of high-performance hierarchical nanostructures. In the case of the initial choice for the optically active nanoparticle for incorporation into hydrogel polymer beads -- the ultrastable CdSe/CdS core/thick-shell quantum dot (QD) -- Matt discovered that reproducibility in QD structure and performance could be significantly enhanced by controlling the quality of the core/shell interface (e.g., by careful handling of the cores prior to shell growth) and by controlling precursor addition at the shell-solvent interface. The latter entailed manipulating QD-QD dipole-dipole interactions to minimize the impact of particle assembly on the

shell growth process. Matt has also explored a novel core/shell/shell hierarchical QD system that has resulted in the remarkable property of dual suppressed-blinking emission (manuscript in preparation for *Nature Materials*). Here, he is able to achieve ultra-stable quantum photoluminescence for two distinct wavelengths from a single QD -- currently red and near-infrared -- as a result of manipulating materials interactions at the nanoscale in designed heterostructures. Further, toward the intended QD-metal nanoparticle hierarchical structures, Matt's QDs have been enveloped in "spacer" silica shells. Finally, to date two approaches to creating QD-metal assemblies have been attempted -- self-assembly from solution and directed assembly using a scanning probe direct-write nanolithography system. Enhancement effects resulting from these hybrid nanostructures (i.e., metal-induced enhancements in radiative rates and emission efficiencies) are being studied in collaboration with others.

Future Work

Cultivating aquatic microalgae in open ponds can generate large quantities of biomass, and recently, Sayre et al. showed a remarkable enhancement in algal growth inside hydrogel polymer beads. Further improvements in hydrogel-confined algae growth rely on efficient light utilization. Our aim is to increase algal growth by "optically activating" hydrogel beads with 1) fluorescent quantum dots (QDs) and 2) metal nanoparticles (MNPs) that exhibit surface plasmon resonance (SPR). These inclusions will color-shift sunlight to wavelengths useful for photosynthesis (UV to blue, green to red) and screen algal cells from damaging UV radiation.

Given his experience during the first 10 months, the postdoc has become very interested in the "multi-domain" aspect of the QD hetero-structures, i.e., how within nominally a single nanostructure, it is possible to incorporate complexity to evoke emergent behavior through internal interface effects. His aim is, therefore, to continue to pursue novel chemistry and photophysical properties in core/multi-shell QD systems, including new non-toxic compositions with utility as color-converting phosphors in algae production. He envisions that the custom automated-synthesis system that will be installed by FY-end in the CINT Nanomaterials Chemistry Laboratory will facilitate the discovery process in the case of QD hetero-structure systems. With respect to MNP-QD couples, we will primarily pursue these through self-assembly approaches and collaborations with others using directed-assembly methods to create precision MNP-QD couples, e.g., via dip-pen lithography.

Conclusion

The project aims to incorporate optically active nanoparticles into hydrogel polymer beads, where the hydrogel matrices serve as an advanced growth medium for algae. The addition of the nanoparticles is expected to serve two functions: color-shift incident sunlight to wavelengths useful for photosynthesis (UV to blue, green to red) and screen algal cells from damaging UV radiation. The ability of the hybrid nanoparticle-hydrogel matrix to support enhanced algal growth will be tested in collaboration with LANL's Algal Biology Program's R. Sayre and team.

Publications

Buck, M. R., A. M. Dennis, H. M. Nguyen, H. Htoon, and J. A. Hollingsworth. Simultaneous near-infrared and visible photoluminescence with suppressed blinking from type-II InP core/shell nanocrystal quantum dots. Presented at 248th American Chemical Society Meeting, Fall, 2014. (San Francisco, August 10-14, 2014).

Buck, M., A. Dennis, F. Wang, H. M. Nguyen, J. Casson, H. Htoon, and J. Hollingsworth. Dual-color suppressed blinking in InP/CdSe/CdS core/shell/shell giant quantum dots. *Nano Letters* (in preparation).

Ultrafast Measurements of Emergent Magnetism in New Complex Oxide Materials

Scott A. Crooker
20140657PRD1

Introduction

Strontium titanate (SrTiO_3) is a foundational material in the emerging field of complex oxide electronics. While its electronic, optical, and lattice properties have been studied for decades, this non-magnetic semiconductor has recently become a renewed materials research focus catalyzed by the surprising discovery of magnetism and superconductivity at interfaces between SrTiO_3 and other non-magnetic semiconducting oxides. The formation and distribution of oxygen vacancies, which donate two electrons for every one vacancy, is widely thought to play an essential but as-yet-incompletely understood role in these observations. Recent signatures of magnetization in gated bulk SrTiO_3 have further galvanized interest in the emergent properties of this material.

To better understand how magnetization is created in these nominally non-magnetic complex oxide materials, we propose to build and use an ultrafast pulsed pump-probe system in the NHMFL optics lab. This wavelength-tunable setup will pump the sample with circularly polarized pulses and probe it with linearly polarized light. In a time-resolved Faraday rotation (TRFR) scheme, a magnetic field is applied to a semiconductor perpendicular to the direction of the light. The pump photo generates short-lived spins that are initially polarized along the direction of the pump beam, which then precess about the applied magnetic field. Because the spin precession, as well as the excited spin relaxation, alters the polarization of the linear probe light as a function of time between the pump and probe pulses, the spin relaxation dynamics can be measured by monitoring the probe polarization.

Benefit to National Security Missions

This project will build Laboratory capabilities in the areas of Materials Science, Emergent Phenomena, and Materials-by-Design, and also in novel measurement methods that enable new scientific discovery at LANL. It is based on the very recent discovery of a new Emergent

Phenomena: optically induced magnetization in complex oxide materials. Our approach for developing ultrafast optical methods to time-resolve magnetization dynamics with sub-picosecond resolution goes well beyond the specific example of strontium titanate that will be investigated here and is applicable to a wide range of new materials in general. The experimental techniques that we will develop as part of this project will advance new Laboratory capabilities that underpin a wide variety of Laboratory missions related to Materials Science and Controlled Functionality in Materials.

Progress

Postdoc Bill Rice received his Director's fellowship in October 2013. Since then, he has made progress on two fronts:

He has developed the experimental capability for Time-Resolved Faraday Rotation, which uses ultrafast pulsed lasers to directly monitor the temporal evolution of magnetization in materials. This is a complicated optical setup, involving femtosecond Ti:sapphire lasers and an Optical Parametric Oscillator to generate ultrafast optical pulses in the red-yellow-orange parts of the optical spectrum. He has this laser system working with our cryogenic instruments to measure samples down to temperatures as low as 1.5 Kelvin.

Now that the experimental capabilities are coming together, Bill has begun a systematic survey of intentionally-doped strontium titanate wafers (iron doped), and also we have started measuring thin film samples grown by molecular beam epitaxy. This work is currently underway.

Based on his recent paper in *Nature Materials*, Bill has also received invitations to present talks at several international conferences.

Future Work

Our immediate goals are (1) to examine this fast relaxation between the ground and excited state(s) and (2) to see if short-lived magnetization can be produced temperatures above 18 K. Tentative evidence suggests that three levels are coupled to a common ground state via circular polarization transition rules. A third goal, therefore, is (3) to perform wavelength-dependent spectroscopy to determine if multiple excited states exist and how/why they energetically split. Additionally, studies of magnetism at oxide interfaces, a “hot” topic in condensed matter physics, can also be investigated using this ultrafast system. In collaboration with Quanxi Jia (MPA-CINT), we plan to investigate spin alignment and dephasing in SrTiO₃/LaAlO₃ heterostructures and other related complex oxide materials in order to shed light on how magnetism is produced at the interfaces of these non-magnetic semiconductors.

Conclusion

We expect to develop experimental tools (based on ultrafast pulsed lasers) that will allow us to “watch” -- in real time -- how magnetization develops and decays in so-called new ‘complex oxide materials’ such as strontium titanate (SrTiO₃) and related compounds. Specifically, we will build and establish the technique of Time-Resolved Faraday Rotation (TRFR), which is an all-optical method using polarized pulsed light that allows one to measure how magnetization develops on the timescale of atomic interactions : millionths of millionths of seconds.

Publications

Rice, W. D., J. D. Thompson, P. Ambwani, C. Leighton, and S. A. Crooker. Revealing optically induced magnetization in SrTiO₃ using optically-coupled SQUID magnetometry and magnetic circular dichroism . 2014. Journal of Vacuum Science and Technology B. 32: 04E102.

Rice, W. D., S. A. Crooker, P. Ambwani, C. Leighton, J. D. Thompson, G. Haugstad, and M. Bombeck. Persistent optically-induced magnetization in oxygen-deficient strontium titanate . 2014. Nature Materials. 13: 481.

Materials for the Future

Postdoctoral Research and Development
Continuing Project

Design Principles for High Performance Organic Photovoltaics

Aditya Mohite
20140658PRD1

Introduction

In this project we will apply innovative interface modification techniques to alter the charge recombination rates across an organic solar cell interface in a bilayer organic photovoltaic device by incorporating a spacer layer with designed functionality. The photo-generated exciton after migration to the donor-acceptor (D-A) interface dissociates due to a strong built-in field setup by the energy level alignment of the donor and acceptor forming a charge transfer or exciplex state (electron is on the acceptor molecule, C60, and hole on donor P3HT). There is a strong tendency for the exciplex state to recombine, which leads to poor photocurrent and thus low power conversion of sunlight to electricity. A few monolayers of the spacer layers are expected to suppress the electron to recombine with the hole and promote the separated electron away from the hole to generate photocurrent. We will use three different types of spacer layers: (a) Insulator (LiF) (b) Oligomer molecules and (c) Heavy Atom. Each of these spacer layers will result in the suppression of the exciplex recombination using different mechanisms. For example, LiF will act like a tunnel barrier, where an optimum thickness of the barrier is expected to completely suppress back recombination. Similarly, in the case of Oligomers, ordering at the D-A interface will control the recombination rate and for the Heavy Atom case, the exciton lifetime is expected to be long due to enhanced spin-orbit coupling, which will impart some triplet character to the singlet state. These strategies are also expected to bring about a deep scientific understanding of interface photo-physical processes that will be universal for heterostructures interfaces created with nanostructures.

Benefit to National Security Missions

This project is in direct alignment with the DOE-BES sunshot initiative and Grand challenges addressed by the BES: By studying this, we will gain control over the transfer of charge and energy flow across interfaces and specifically learn to control the following:

- Reveal the design principles for the efficient conversion of light to energy
- Develop mesoscale devices starting from model systems
- Apply the fundamental understanding to practical architectures such as bulk heterojunctions (BHJ) for organic solar cells and also for other types of light to energy conversion applications.

Progress

Key accomplishments:

- Wanyi Nie has already fabricated organic solar cell devices and tested two interface modification strategies in a model bilayer device.
- The results show a dramatic improvement (500%) in the overall power conversion efficiency of an organic solar cell.
- Wanyi has performed measurements to understand the interface morphology and interface ordering to correlate the atomistic origin of the interface to the overall device performance.

Several characterization measurements and other interface modification strategies are currently being tested in other type of solar cell devices and other optoelectronic devices so that these strategies are universally applicable to any device where the charge transfer and energy transfer occur across an interface.

Future Work

We will use three different types of spacer layers: (a) Insulator (LiF) (b) Oligomer molecules and (c) Heavy Atom. Each of these spacer layers will result in the suppression of the exciplex recombination using different mechanisms.

In the coming year, we will incorporate these strategies

to demonstrate that these are universally applicable to enhancing the charge transfer process in a wide variety of material systems based on organic-inorganic and inorganic-inorganic interfaces. We will specifically try these strategies on perovskite solar cells, layered 2D heterostructures and also in oxygen reduction reaction (ORR) in fuel cells.

Conclusion

The success of this proposal will result in obtaining universal design rules that will guide the fabrication of high efficiency photovoltaics using nanostructure materials. These design principles will be applicable to several other applications such as organic light-emitting diodes (OLEDs), sensors, photo-catalysis, etc.

Publications

Nie, W., G. Gupta, F. Liu, P. Ruden, H. Li, D. Smith, H. Wang, T. Hsinhan, S. Tretiak, and A. D. Mohite. Interface Design Principles for High Efficiency Organic Semiconductor Devices. *Nature Communications* (in review).

Materials for the Future

Postdoctoral Research and Development
Continuing Project

Synthesis of Novel Energetic Materials

David E. Chavez
20140659PRD1

Introduction

This project will focus on the development of novel energetic materials that are thermally stable but can be initiated through the use of unprecedented mechanisms such as photochemical or electrochemical stimulation to novel excited states. The research will focus on the synthesis of molecules with kinetic barriers large enough to prevent thermally induced detonation and excited states capable of bypassing those barriers in response to non-thermal stimulus (optical or electrochemical stimulation).

Benefit to National Security Missions

Los Alamos National Laboratory is a world leader in the synthesis and development of energetic materials. The design of a new class of explosives with controlled initiation properties has the potential to enhance safety and could have applications in detonator development and weapons programs. The proposed work will contribute to the Laboratory's core missions of new energetic materials development and threat reduction science. The fundamental nature of the work could have an impact in the basic understanding of materials and chemistry.

Progress

Thomas began his post-doctoral position at Los Alamos on May 27th, 2014. Since his arrival, initial work has focused on completing required safety and security training. A number of promising technical leads have been identified and experimental work will begin in the lab wing of TA 9 in the coming weeks.

Future Work

Thomas completed training and began working at LANL in the last quarter of FY 14. The same work plan will continue in FY 15.

Tasks to be accomplished:

- Characterization of tetrazine ligands

- Reactions of tetrazine ligands with metals, characterization of products

Conclusion

The technical goals of the project are to produce new optically active energetic materials that respond to non-thermal stimuli. The anticipated impact will be in the area of controlled initiation of energetic materials for applications. Access to such materials will significantly enhance the safety and surety of many systems employing energetic materials.

Investigating Structure-Directing Agents in Nonconventional Nanowire Synthesis Using a Transmission-Electron-Microscope Flow-Cell Holder

Jennifer A. Hollingsworth
20140661PRD1

Introduction

Understanding the growth mechanisms for one-dimensional (1D) semiconductor nanostructures, especially more complex 1D heterostructures including superlattice, core/shell, and dumbbell-like structures, is essential for the controlled synthesis of these novel architectures. Importantly, structural control is anticipated to enable properties control, where the ability to tune transport properties, charge separation efficiencies, and charge or energy transfer processes underpins a range of applications from energy conversion and storage to catalysis and photodetection. To date, however, controlled solution-phase growth of high quality and intentionally designed 1D heterostructures is still in the very early stage. Improved methods for establishing the structure-controlling mechanisms and, thereby, for increasing the pace of materials discovery and development are needed.

The work will take advantage of the postdoc's expertise in glycol-based solution-assisted low-temperature refluxing processes for synthesizing tellurium-based semiconductor nano-heterostructures for thermoelectric applications, along with LANL's new capability in situ liquid-phase transmission electron microscopy (TEM). The latter will enable an unprecedented systematic assessment of nanowire and nanowire heterostructure formation real-time by direct imaging under the conditions of growth. Nanowires will be synthesized in the TEM flow cell, permitting direct assessment of the impact of reaction parameters on nanowire formation and growth progression. Glycol-based syntheses are scalable and afford a lower temperature alternative compared to higher temperature and more costly solution-phase and vapor-phase approaches. And yet, they are also capable of yielding high-quality, single-crystalline materials. The specific 1D nanostructures studied here will support advances in thermoelectrics and topological insulator applications, with important consequences for waste-heat energy harvesting (more than half of the energy gener-

ated worldwide is lost as heat), heat management in the electronics industry, remote power generation, etc. If successful, to our knowledge, this will also be the first real-time in situ imaging of nanowire growth processes in solution.

Benefit to National Security Missions

The work will advance fundamental understanding of nanomaterials growth mechanisms, which will enable new materials-by-design strategies. It will also advance our understanding of chemical processes that take place at nano/meso-interfaces and how these influence structure and ultimately function. Together, these contribute directly to DOE/SC, Basic Understanding of Materials and Fundamental Chemistry missions. It will also advance a new capability in liquid-phase transmission electron microscopy, propelling LANL to the forefront of this emerging and important research area. This capability will enable direct assessments (with enhanced efficiency and accuracy compared to 'post-mortem' assessments) of the impact of growth parameters on morphology, composition and interface evolution. This same technique can also be applied to studying corrosion processes and the impact of chemical or high-energy electron dosing on both growth and degradation of surfaces or three-dimensional structures, with relevance to MaRIE and stockpile stewardship. Finally, the nanowire materials produced will have direct relevance to energy harvesting (energy security, remote power generation) and cooling (e.g., spot cooling in electronics) applications, with fundamental understanding translatable to other nanowire materials systems that have potential applications in chem/bio sensing.

Progress

The postdoc arrived ~3 weeks ago and has completed all training, with the exception of one live course that will take place this Thursday. He is currently conducting background research, placing orders for materials & supplies, and attending team meetings.

Future Work

The postdoc will begin to address two project aims: (1) To understand the controlling variables in polyol syntheses that determine nanowire diameter and use this understanding to synthesize ultrathin sub-5 nm wires (currently a key synthetic challenge to access nanowires below 10 nm) and (2) To monitor the impact of molecular “capping agents” or reactive cations on the formation of core/shell or superlattice heterostructures, respectively. Together, these aims address a need in the fields of thermoelectrics and topological insulators for ultrathin bismuth or lead chalcogenide nanowires (e.g., Bi₂Te₃ or PbTe, respectively) and their heterostructures (e.g., where PbSe/PbTe superlattices were predicted by Dresselhaus (PRB 2003) to afford a game-changing thermoelectric figure-of-merit: $ZT > 6$, if nanowire diameter could be controlled to < 5 nm and segment lengths to only 2-3 nm).

The postdoc will synthesize nanowires in LANL’s transmission electron microscopy (TEM) flow cell, directly assessing the impact of reaction parameters on nanowire formation and growth progression. Post-synthesis methods for modifying single-composition nanowires into heteronanowires, either core/shell or axial superlattices, will also be studied. This will be facilitated by “pinning” nanowires to a solid substrate using a focused ion beam (FIB) technique to apply a metal “tack” to one end of the nanowire. The substrate will be put into the flow cell, and shell components along with reagents that allow tuning of interfacial and strain energies will be flowed past the pinned-down nanowires. Thus held in place, these wires will enable imaging over long times facilitating for the first time the observation of heterostructure evolution. Similarly, we will react pinned wires with cations to attempt conversion to superlattices by way of partial cation exchange (or a controlled Kirkendall effect), which can convert single-composition nanostructures into multi-composition heterostructures, including superlattice examples [Robinson et al. Science 317, 355 (2007)].

Conclusion

The project will advance the state-of-the-art in liquid-phase transmission electron microscopy (TEM). By pushing boundaries in terms of how the parameters and processes that influence nanomaterial’s growth are assessed, the project will also afford new mechanistic understanding that will enable ‘materials-by-design’ of complex, functional one-dimensional semiconductor nanostructures for applications from energy conversion and storage to catalysis and photodetection.

Photoactive Energetic Materials for Quantum Optical Control

Sergei Tretiak
20140668PRD2

Introduction

Understanding and controlling excited state dynamics (spatial energy transfer, excitation localization/delocalization, and/or charge separation) lies at the heart of all our efforts to design photoactive materials with desired functionality. Photoinitiation requires non-adiabatic (non-radiative) conversion of excess electronic energy into specific vibrational degrees of freedom mediated by the electron-phonon coupling. Excited states have varying electron-phonon couplings, and depending on their localization and energy, lead to different relaxation pathways. This structure provides a “landscape” for optical control (steering the outcome of a chemical reaction with light) based on which excitations are selected. Non-adiabatic excited-state molecular dynamics (NA-ESMD) simulations provide a detailed understanding of key photoinduced phenomena controlling competing interactions and relaxation pathways in complex materials.

Benefit to National Security Missions

The proposed work will increase the controllability of chemical dynamics by predicting and controlling the functionality of materials. The proposed work will further LANL’s reputation and prestige in quantum control and molecular design. Control of explosive initiation would be transformational for LANL’s core missions of stockpile safety and energetic materials.

Progress

Over the past year, significant changes have been done to the non-adiabatic excited state molecular dynamics (NA-ESMD) codes toward implementation of solvent contributions. A Polarizable Continuum Model (PCM) has been implemented. This allows us to conduct simulations of excited state dynamics in the presence of the simple solvent environment. We have also been developing theoretical formalism on how to compute gradients along the excited state potential energy surfaces. Finally several numerical tests on representative

molecules in solvent environment have been conducted and the results are now being summarized in an article to be submitted for publication.

Future Work

Our work will start with testing a prototype code incorporating solvent at the Polarizable Continuum Model (PCM) level, which is a critical step toward implementing an explicit solvent environment. Next a combined quantum mechanical and molecular mechanical (QM/MM) approach to treat large systems and include solvent and thermal bath effects will be developed. QM/MM is a much more accurate approach in which a system is divided into a quantum mechanical region and a molecular mechanical region allowing realistic modeling of dielectric media. Depending on the molecular system, different force fields will be interfaced with our existing non-adiabatic excited-state molecular dynamics (NA-ESMD) code. In terms of applications, photoactive energetic materials with controllable optical functionality will be studied. Specific vibrational degrees of freedom responsible for bond breakage, rapid decomposition, and the onset of the exothermic chain reactions relevant to explosive initiation processes in the surrounding material will be identified. Secondly, we will use the developed methodology to design and propose controllable materials. Detailed numerical NA-ESMD simulations to investigate photoinduced pathways, timescales, branching effects, and multiple product formation, which can be experimentally validated by ultrafast spectroscopy capabilities, will be performed. Possible photoinduced reaction coordinates and electron-vibrational relaxation pathways to elucidate mechanisms for optical initiation will be assessed. Thirdly, first principle electronic structure calculations will be used to quantitatively evaluate the nonlinear optical responses to understand excited-state properties and to provide design strategy for new photoactive energetic materials.

Conclusion

The proposed implementation of the quantum mechanical and molecular mechanical (QM/MM) approach will provide novel computational capabilities critical for understanding light-induced dynamics in many technologically relevant materials. Specifically, this will allow us to simulate large molecular systems where full ab-initio calculations are prohibitively expensive, and to describe systems that interact strongly with solvent environments. Such simulations have been done previously for the ground state but were never attempted for excited states due to computational complexity.

Publications

Nelson, , Fernandez-Alberti, A. E. Roitberg, and Tretiak.
Nonadiabatic Excited-State Molecular Dynamics: Modeling Photophysics in Organic Conjugated Materials.
2014. ACCOUNTS OF CHEMICAL RESEARCH. 47 (4):
1155.

Ultrafast Carrier Dynamics in Novel Two-Dimensional Nanomaterials

Victor I. Klimov
20140675PRD3

Introduction

Semiconductor nanomaterials are a versatile materials platform that exhibit novel physical phenomena not found in their bulk counterparts. A detailed understanding of the physical factors controlling the electronic properties will allow for the development of materials with tailored electronic properties. Recent advances in synthetic methods have allowed for the synthesis of nearly atomically thin two-dimensional nanosheets comprised of molybdenum disulfide and diselenide (MoS₂ and MoSe₂). These direct gap semiconductors have already shown promise for use in next generation transistors as well as other electronic applications. However, the underlying electronic properties of these materials remain largely unexplored and unknown. To this end, we will explore the carrier dynamics in these materials with femtosecond spectroscopy. Experiments will elucidate the time scales of carrier relaxation, exciton binding energies, as well as the strength of multicarrier interactions. Due to the quasi-two-dimensional confinement of the electrons in the material, the Coulomb interactions between carriers are significantly enhanced relative to current semiconductor nanocrystals. The strong Coulomb interaction can give rise to room temperature excitonic phenomena and enhance multicarrier processes that are typically only observed at extremely low temperatures. The insights gained from this project will facilitate an understanding of the fundamental electronic properties of these materials.

Benefit to National Security Missions

Agency Relevance

The primary goal of this project is to explore the electronic properties of a new class of two-dimensional semiconductor materials. As such, the results will be valuable to the DOE's Office of Science.

Mission Relevance/MaRIE

Since we are studying charge carrier interactions at extremely high densities in these two-dimensional semi-

conductors, the insights from this project could potentially benefit MaRIE.

Scientific Discovery and Innovation/Basic Understanding of Materials

Through ultrafast laser spectroscopy of these semiconductor nanosheets, we will establish the role of two-dimensional quantum confinement on intraband carrier cooling, Auger recombination and other multi-carrier interactions, significantly contributing to the basic understanding of these novel nanomaterials.

Progress

As of this report, the postdoc had only recently been hired.

Future Work

We are interested in further understanding the optical properties of MoS₂ and MoSe₂, a class of two-dimensional nanomaterials with a thickness of three atoms. The extremely thin materials facilitate increased interactions between charge carriers, which should result in novel physical phenomena. To gain insight into the new physics that arise in strongly confined two-dimensional materials we will utilize femtosecond transient absorption spectroscopy in conjunction with time-resolved photoluminescence experiments to probe the carrier dynamics. Through tuning of the power of the excitation beam, the dynamics of multicarrier processes will be measured. Due to the increased interactions between carriers we expect to find a corresponding increase in the multicarrier recombination rate, as well as potentially bound multiexciton states that are typically only observed at temperatures approaching absolute zero. Tuning of the probe wavelength across the spectra will allow for the relaxation process to be directly monitored as well as resolving the energies of higher-lying excited states. Saturation experiments will also reveal the degeneracy of the transitions, providing a detailed understanding of the energy level structures that lead to the

unique properties found in MoS₂ and MoSe₂.

Conclusion

These studies of MoS₂ and MoSe₂ nanosheets will elucidate how the precise shape and size of quasi-two-dimensional materials controls their optical and electronic properties. We expect that the two-dimensional character of charge carriers will enable increased interactions between carriers leading to novel physics. The insights gained from this research will further our understanding of the effect of dimensionality on electronic structure and dynamics.

New Room Temperature Multiferroic Thin Films Enabled by Strain Engineering

Quanxi Jia

20140676PRD3

Introduction

Multiferroic materials have attracted extensive interests owing to their potential technological applications as multifunctional devices. However, the single-phase multiferroic materials are rare because of the distinct nature of magnetism and ferroelectricity. Seeking nanocomposite multiferroic materials, therefore, becomes recent research focus. Strain engineering provides an important approach to yield new functional materials with novel properties. Very recently, we have demonstrated a new class of multiferroics ($\text{BiFe}_{0.5}\text{Mn}_{0.5}\text{O}_3$ or BFMO) based on two partially miscible phases of BiFeO_3 and BiMnO_3 using epitaxial strain. Fully strained BFMO/LaAlO₃ (LAO) superlattices with controlled layer thickness and periodicity could be a very promising way to realize new room temperature multiferroic materials. We will take the advantages of well-equipped capabilities at Los Alamos National Laboratory (such as laser molecular beam epitaxy, high resolution x-ray diffraction, transmission electron microscopy, and transport characterization tools) to systematically study the highly strained BFMO/LAO superlattice structures.

Benefit to National Security Missions

This project focuses on fabrication, properties, and microstructure characterization of advanced nanostructured superlattice with an emphasis on room temperature multiferroic materials. The proposed effort supports and strengthens the Laboratory's core scientific capabilities essential to discovering, understanding, and exploiting emergent phenomena in materials. This project also directly addresses the Grand Scientific Challenge identified in the DOE BESAC report: how do remarkable properties of matter emerge from the complex correlations of atomic or electronic constituents and how can we control these properties?

Progress

As of this report, postdoc had only recently been hired.

Future Work

Fully strained $\text{BiFe}_{0.5}\text{Mn}_{0.5}\text{O}_3$ (BFMO)/LaAlO₃ (LAO) superlattices with controlled layer thickness and periodicity could be a very promising way to realize new room temperature multiferroic materials. The well-equipped capabilities at Los Alamos National Laboratory (such as laser molecular beam epitaxy, high resolution x-ray diffraction, transmission electron microscopy, and transport characterization tools) will enable us to carry out the following proposed tasks with success. Specifically, we will carry out the following tasks: i) using laser molecular beam epitaxy to create strained BFMO/LAO superlattices, where the strain will be controlled by either the layer thickness or the substrate material (or lattice parameter); and ii) using advanced structural probing tools and transport measurements to characterize the superlattices so that the structure-functionality relationship can be established at the end of the project.

Conclusion

This project focuses on fabrication, properties, and microstructure characterization of advanced nanostructured superlattice with an emphasis of room temperature multiferroic materials. We expect that the structure-functionality relationship of this new class of multifunctional materials can be established at the end of the project.

Publications

Chen, A., W. Zhang, F. Khatkhatay, J. L. MacManus-Driscoll, H. Wang, and Q. X. Jia. Mechanisms of resistive switching in ferroelectric memristors. *Adv. Mater.*

Rational Design of Multiferroics and Influence of Cationic Disorder on Multiferroicity in Perovskites

Blas P. Uberuaga
20140679PRD3

Introduction

Ferroelectricity and magnetism in solids have seemingly different origins. While magnetism is related to ordering of spins of electrons in incomplete ionic shells, ferroelectricity results from a delicate balance between long-range coulombic dipole-dipole interactions and short-range repulsive forces. Materials in which ferroelectricity and ferromagnetism exist simultaneously are known as multiferroic materials. Multiferroics can, in principle, enable novel and revolutionary future energy, sensing, and information technologies. However, ferroelectric ferromagnets are exceedingly rare.

The proposed research effort seeks to enable rational design of novel thin-film multiferroic materials. We aim to develop a design strategy to systematically navigate through the chemical space of magnetic perovskite oxides (ABO₃ systems) using quantum mechanical computations in combination with thermodynamics based models and materials informatics. State-of-the-art computations will be used to explore and understand coupling between ferroelectricity and magnetism for a range of ABO₃ compounds as a function of composition, strain and nominal charge states of A and B site cations. Advanced density functional theory based computations such as those with hybrid functionals (to appropriately account for the self-energy of a many-body system of electrons) will be used for a further careful investigation and validation of the identified promising material candidates with multiferroic behavior.

A key objective of this effort would be to assess the effect of crystalline cationic disorder on the magnetism, ferroelectricity and their coupling in perovskites. Crystalline disorder in magnetic perovskites is expected to strongly influence both the local magnetic structure as well as the polar phonon modes. However, the atomic scale mechanisms through which crystalline cationic disorder and multiferroicity couple in magnetic perovskites are not well understood at present and will be specifi-

cally targeted in this work.

Benefit to National Security Missions

This research is of direct relevance to the missions above as the ability to rationally design multiferroics will enable novel and revolutionary future energy, sensing, and information technologies in which the low power and high speed of field-effect electronics are combined with the permanence and routability of voltage-controlled ferromagnetism. This paradigm has the potential to mitigate the costs, risks and time involved in preparing and testing of multi-functional materials. Further, this research should yield insights into the fundamental factors underlying materials behavior, providing the basic understanding needed to further develop novel materials and material architectures for advanced energy applications. Finally, an atomic-level understanding of the influence of crystalline disorder on multiferroic behavior would directly translate to better device performance.

These goals are of direct relevance to the missions of DOE/BES and LANL, particularly the laboratory's science pillar of Materials for the Future.

Progress

As of this report, the postdoc is awaiting to be hired.

Future Work

In the first fiscal year, our theoretical investigation will focus on two aspects. On one side, we will look at the effect of crystalline cationic disorder on ferroelectricity. On the other, high-throughput exploration of a range of stable (i.e. formable) perovskite at different levels of biaxial strain will be carried out. The biaxial strain will be imposed in a constrained bulk approach to mimic an epitaxially grown thin-film situation. Each of the chosen ABO₃ compound would be required to meet several stability criteria dictated by charge neutrality (sum of the allowed nominal oxidation states of the A and B ions will be required to be +6 to balance the -6 oxidation

state of the 3 O atoms), tolerance factor (based on empirical knowledge that the ionic sizes of the A and B cations have to conform to certain restrictions in order to form a stable perovskite structure), thermodynamic stability and non-zero band gap. A non-zero band gap constraint will be imposed for the initial level of screening, since a metal cannot sustain a macroscopic polarization induced as a result of ferroelectricity.

The systems that show significant macroscopic polarization will next be substitutionally doped with B-site magnetic cations. The B-site magnetic perovskite oxides are of particular interest, since the larger exchange coupling in their case results in much higher magnetic ordering temperatures as compared to that of A-site rare-earth systems such as EuTiO_3 . This round will begin by systematically performing optimizations of a twenty-atom unit cell of the cubic perovskite structure in the various possible ferroelectric distortions in combination with four possible magnetic configurations, namely the G-AFM, C-AFM, A-AFM and FM states. The generated database will then be analyzed by conventional and machine learning methods to learn for trends and identify promising material candidates.

Conclusion

We expect to systematically screen the chemical space of magnetic perovskites to identify promising multiferroics. The proposed research effort is expected to deliver new insights into the factors that govern coupling between ferroelectricity and ferromagnetism in perovskite materials. By systematically exploring strain-(polar) phonon coupling and spin-phonon coupling in a range of material systems, we seek to identify and understand mechanisms that control spin-phonon-strain behavior in these materials. An atomic-level understanding of the influence of crystalline disorder on multiferroic behavior would directly translate to a better device performance and an improved control over the functionality.

Materials for the Future

Postdoctoral Research and Development
Continuing Project

Shock-Driven Material Dynamics Investigated by Ultrafast X-ray Diffraction

Cynthia A. Bolme
20140680PRD3

Introduction

This project will employ high brilliance x-ray sources to study the dynamic response of materials at the level of the crystalline lattice during shock compression. The ability to study highly deformed and strained materials during shock compression is only possible at a few facilities in the world due to the very short time duration of shocks and the necessity to have many x-ray photons during the shock. One capability in particular, the measurement of liquid and amorphous material structures, has only been demonstrated at one facility, the Linac Coherent Light Source (LCLS), which is the world's first hard x-ray free electron laser. X-ray free electron lasers have only been used to study shocked materials for a few years, and the intricacies of these types of experiments are just beginning to be understood. The data acquired will be able to inform our understanding of the basic processes by which materials undergo deformation and phase transitions, which may lead to the ability to design materials with specific functional properties, such as high strength or a high elastic limit.

Benefit to National Security Missions

This work addresses mission challenges in the NNSA defense programs relating to dynamic materials performance. These experiments will lead to a better fundamental understanding of materials and their response to dynamic loading conditions through deduction of the specific deformation mechanisms at work. The gains in fundamental material understanding have potential impacts on the defense programs mission by informing modeling efforts of the relevant mechanisms and material properties that should be parameterized to improve the fidelity of material models.

These experimental efforts are also directly relevant to the MaRIE signature facility because we are learning the important nuances of performing dynamic compression experiments on an x-ray free electron laser, one of the major drivers for building MaRIE. This research will help

show the relevance of these material dynamics experiments to the weapons program and will help define the photon beam parameters for the MaRIE free electron laser.

Progress

As of this report, postdoc is awaiting to be hired.

Future Work

During the next fiscal year, we will analyze in situ x-ray diffraction data of the shock-driven phase transition of quartz to stishovite. This data should show the mechanism by which the atoms are rearranged into the stishovite crystal structure and will lead to a scientific journal publication. We will also analyze diffraction data of shock-driven phase transitions in H₂O.

We will submit a beam time proposal to investigate the strength of shock-compressed metals using the Matter in Extreme Conditions instrument at the Linac Coherent Light Source (LCLS). If we are successful in receiving beam time for the proposed experiment, we will plan, prepare samples, and execute the experiment.

Conclusion

This project seeks to provide fundamental new insight into deformation and phase transition processes under shock-loading. The in situ measurements on the high pressure phase transition of quartz to stishovite will provide the first data on the lattice level response of this shock-driven transition and will be important to the geophysics community for understanding the dynamics of meteor impacts.

Quantum simulations: From superconductivity to nanoscale electronics

Eddy M. Timmermans

20110711PRD2

Abstract

This project developed a theoretical framework to guide and analyze ultra-cold atom simulations of nano-transport and of quantum many-body effects in superconductors. The cold atom systems exhibit physical similarity with quantum many-body systems and quantum many-body phenomena in condensed matter, nanoscale science, and quantum information. These quantum simulations use the highly accessible and controllable nature of one quantum system (here, a cold atom cloud) to create simplified analogs of complex materials and devices in order to gain direct theoretical and experimental insight into the underlying physical phenomenon. This project has developed schemes for the emulation of various superconductors in cold atom setups. These emulations can address issues that occur in systems that are inaccessible in traditional condensed matter settings. In particular, the project developed a unified theory of spectroscopic measurements on cold atom and superconducting systems in order to help understand the mechanisms of high-T_c superconductivity as revealed by cold-atom simulations. These studies also provided a starting point for the description of nonequilibrium effects in nanoscale electronic systems, which are systems of greater complexity, and led to the proposal of new measurement techniques capable of probing the cold atom systems. These measurements can elucidate the role of electron-electron interactions and dissipation in electronic transport – effects that are difficult to capture in traditional theoretical approaches to transport. The PD has characterized promising methods for extracting information from cold atom systems that may reveal the driving phenomena that underpin high-T_c superconductivity. Superconducting materials have the potential to revolutionize electrical power distribution, i.e., create more efficient means of distributing electricity that will be helpful in moving to green sources of energy among other things. Also, the PD investigated nonequilibrium and inhomogeneous cold atom systems in order to understand quantum effects in electronic transport, which

is crucial in designing functional nanoscale devices.

Background and Research Objectives

The recent cold atom advances in engineering optical potentials allow the study of many-body quantum physics in highly accessible, nearly macroscopic systems. Contrary to conventional materials, ultra-cold atom “materials” allow for their interactions, lattice geometries, and spatial dimensions to be tuned by adjusting the magnetic field. This project consisted of two thrusts that benchmarked cold-atom simulations of superconductivity and nanoscale devices: (1) Building on past studies on spectroscopic techniques, the PD developed a unified description of probing techniques of superconductivity and cold atoms. (2) Starting from recent progress on non-equilibrium atoms in engineered potentials, the PD devised scenarios that connect electronic transport theories to ultra-cold atomic experiments. Superconductivity is one of the most significant discoveries in the 20th century. Nevertheless, impurities and material-dependent properties hinder the investigation of the mechanism for high-temperature (high-T_c) superconductivity. For example, conventional resistivity measurements show only a smeared transition from non-zero to zero resistance. Moreover, non-superconducting electrons coexist with superconductivity in high-T_c materials. Thus, researchers resort to advanced techniques such as Raman spectroscopy, which can detect the regions of the electronic phase space that are superconducting. However, those techniques lack a consistent interpretation and so far cannot unambiguously identify superconductivity from the background due to impurities and disorder. Free of these latter effects, ultra-cold atoms provide new venues to explore high-T_c superconductivity.

Scientific Approach and Accomplishments

Using advanced quantum-mechanical methods the PD described the thermal equilibrium of many-body quantum systems such as one and two-component bosonic

cold atom mixtures [1-5] while including the effects of strong inter-particle interactions. In the one-component boson systems the PD addressed a long-standing issue of describing the interaction dependence of the critical temperature for Bose-Einstein condensation [2-5]. The PD found that competing phases could exist with different symmetry breaking characteristics and different critical temperatures. In two-component mixtures [2], two phases can persist at higher temperatures. Moreover, in cold atom systems, the inter-species interactions can be controlled by an external magnetic field. The PD then generalized the theory framework to include dynamical effects when the interaction is changed suddenly [7]. From the PD's simulations we observed that the system develops interesting patterns reflecting the stable state after the change. This work may shed light onto multi-species superconductors and superfluids. The cold atom descriptions also provided a convenient starting point to address fundamental symmetry-breaking properties of fermion superfluids [8-9], possibly in the limit of maximal interaction [10-11], and of pseudogap states [12-14]. In work on nanotransport, the PD explored the interplay of interaction and temperature effects in cold atom [15-17] as well as nano- [18] and bio- [19-20] systems. The PD found that the heat transport properties of DNA molecules could change dramatically when DNA dissociates from its double-helix structure to two single strands due to high temperature [20]. The PD proposed a device that utilized this property of DNA. This device has a piece of DNA clamped by two metallic leads with different temperatures. By choosing different sequences or length of DNA, this device has thermal switching behavior at different temperatures. The PD published the design. Immediately after his publication, a European and a US group performed experiments and demonstrated the main effects.

Impact on National Missions

This work may bring a better understanding of high-T_c superconductors: materials with zero electrical resistance. These materials may have important energy applications in the future. If they can be used reliably they can eliminate virtually all the loss of energy that goes into resistive heating in the conductors that transmit the electrical energy. The research of this project may also advance the fundamental understanding of materials on the basic quantum level. Both goals are becoming focus areas for numerous sponsors including DOE and BES, for example, for applied and basic aspects.

References

- Chien, C. C., F. Cooper, and E. Timmermans. Large-N approximation for single- and two-component dilute Bose gases . 2012. Physical Review A. 86: 023634.
- Cooper, F., B. Mihaila, J. F. Dawson, C. C. Chien, and E. Timmermans. Auxiliary field approach to dilute Bose gases with tunable interactions . 2011. Physical Review A. 83: 053622.
- Cooper, F., C. C. Chien, B. Mihaila, J. F. Dawson, and E. Timmermans. Composite-field Goldstone states and Higgs mechanism in dilute Bose gases . 2012. Physical Review A. 85: 023631.
- Dawson, J. F., F. Cooper, C. C. Chien, and B. Mihaila. Leading-order auxiliary field theory of the Bose-Hubbard model. . 2013. Physical Review A. 88: 023607.
- Mihaila, B., F. Cooper, J. F. Dawson, C. C. Chien, and E. Timmermans. Analytical limits for cold-atom Bose gases with tunable interactions . 2013. Physical Review A. 84: 023603.
- Chien, C. C., J. She, and F. Cooper. Mean-field description of pairing effects, BKT physics, and superfluidity in 2D Bose gases . Annals of Physics.
- Chien, C. C., and F. Cooper. Quench dynamics and emergence of phase separation in two-component atomic Bose gases at zero temperature and above the BEC critical temperature . 2013. Physical Review A. 87: 045602.
- Guo, H., C. C. Chien, and Y. He. Gauge invariant linear response theory of relativistic BCS superfluids . 2012. Physical Review D. 87: 074025.
- Guo, H., C. C. Chien, and Y. He. Theories of linear response in BCS superfluids and how they meet fundamental constraints . 2013. Journal of Low Temperature Physics. 172: 5.
- Guo, H., Y. He, C. C. Chien, and K. Levin. The compressibility in strongly correlated superconductors and superfluids: from BCS to BEC . 2013. Physical Review A. 88: 043644.
- Guo, H., Y. Li, Y. He, and C. C. Chien. Density and spin linear response of atomic Fermi superfluids with population imbalance in BCS-BEC crossover . Physical Review A.
- Wulin, D., B. M. Fregoso, H. Guo, C. C. Chien, and K. Levin. Conductivity in Pseudogapped Superconductors: The Role of the Fermi Arcs . 2011. Physical Review B. 84: 140509.
- Wulin, D., H. Guo, C. C. Chien, and K. Levin. Spin Transport in Cold Fermi gases: a Pseudogap Interpretation of Spin Diffusion Experiments at Unitarity . 2011. Physical

Review A. 83: 061601.

14. Wulin, D., H. Guo, C. C. Chien, and K. Levin. Two-component optical conductivity in the cuprates: A necessary consequence of preformed pairs . 2012. *Physical Review B*. 86: 134518.
15. Chien, C. C., and M. Di Ventra. Dynamical crossover between the infinite-volume and empty-lattice limits of ultra-cold fermions in 1D optical lattices . 2012. *Europhysics Letters*. 99: 40003.
16. Chien, C. C., and M. Di Ventra. Controlling transport of ultra-cold atoms in 1D optical lattices with artificial gauge fields. . 2013. *Physical Review A*. 87: 023609.
17. Chien, C. C., M. Zwolak, and M. Di Ventra. Bosonic and fermionic transport phenomena of ultra-cold atoms in 1D optical lattices . 2012. *Physical Review A*. 85: 041601.
18. Doi, K., M. Tsutsui, T. Ohshiro, C. C. Chien, M. Zwolak, M. Taniguchi, , T. Kawai, S. Kawano , and M. Di Ventra. Electrochemical response of biased nanoelectrodes in solution . To appear in *Journal of Physical Chemistry C*.
19. Velizhanin, K., C. C. Chien, Y. Dubi, and M. Zwolak. Driving denaturation: Nanoscale thermal transport as a probe of DNA melting . 2011. *Physical Review E*. 83: 050906.
20. Chien, C. C., K. A. Velizhenin, Y. Dubi, and M. Zwolak. Tunable thermal switching via DNA-based nano devices. . 2013. *Nanotechnology*. 24: 095704..

Publications

- Chern, G. W., C. C. Chien, and M. Di Ventra. Dynamically generated flat-band phases in optical kagome lattices. 2012. *Physical Review A*. 85: 041601(R).
- Chien, C. C.. Spatially varying interactions induced in atomic gases by optical Feshbach resonance . 2012. *Physics Letters A*. 376: 729.
- Chien, C. C., D. Gruss, M. Di Ventra, and M. Zwolak. Interaction-induced conducting-nonconducting transition of ultra-cold atoms in 1D optical lattices . 2013. *New Journal of Physics*. 15: 063026.
- Chien, C. C., F. Cooper, and E. Timmermans. Large-N approximation for single- and two-component dilute Bose gases . 2012. *Physical Review A*. 86: 023634.
- Chien, C. C., H. Guo, and K. Levin. Comment on “Density and spin response of a strongly-interacting Fermi gas in the attractive and quasi-repulsive regime”. 2012. *Physical Review Letters*. 109: 118901.

- Chien, C. C., K. A. Velizhenin, Y. Dubi, and M. Zwolak. Tunable thermal switching via DNA-based nano devices. 2013. *Nanotechnology*. 24: 095704.
- Chien, C. C., M. Zwolak, and M. Di Ventra. Bosonic and fermionic transport phenomena of ultra-cold atoms in 1D optical lattices . 2012. *Physical Review A*. 85: 041601.
- Chien, C. C., and F. Cooper. Quench dynamics and emergence of phase separation in two-component atomic Bose gases at zero temperature and above the BEC critical temperature. 2013. *Physical Review A*. 87: 045602.
- Chien, C. C., and M. Di Ventra. Dynamical crossover between the infinite-volume and empty-lattice limits of ultra-cold fermions in 1D optical lattices . 2012. *Europhysics Letters*. 99: 40003.
- Chien, C. C., and M. Di Ventra. Controlling transport of ultra-cold atoms in 1D optical lattices with artificial gauge fields. 2013. *Physical Review A*. 87: 023609.
- Cooper, F., B. Mihaila, J. F. Dawson, C. C. Chien, and E. Timmermans. Auxiliary field approach to dilute Bose gases with tunable interactions . 2011. *Physical Review A*. 83: 053622.
- Cooper, F., C. C. Chien, B. Mihaila, J. F. Dawson, and E. Timmermans. Composite-field Goldstone states and Higgs mechanism in dilute Bose gases . 2012. *Physical Review A*. 85: 023631.
- Dawson, J. F., F. Cooper, C. C. Chien, and B. Mihaila. Leading-order auxiliary field theory of the Bose-Hubbard model. 2013. *Physical Review A*. 88: 023607.
- Guo, H., C. C. Chien, Y. He, and K. Levin. Fundamental constraints on linear response theories of Fermi superfluids above and below T_c . 2013. *International Journal of Modern Physics B*. 27: 1330010.
- Guo, H., C. C. Chien, and Y. He. Gauge invariant linear response theory of relativistic BCS superfluids . 2012. *Physical Review D*. 85: 074025.
- Guo, H., C. C. Chien, and Y. He. Theories of linear response in BCS superfluids and how they meet fundamental constraints. 2013. *Journal of Low Temperature Physics*. 172: 5.
- Guo, H., Y. He, C. C. Chien, and K. Levin. The compressibility in strongly correlated superconductors and superfluids: from BCS to BEC. 2013. *Physical Review A*. 88: 043644 .
- Mihaila, B., F. Cooper, J. F. Dawson, C. C. Chien, and E. Timmermans. Analytical limits for cold-atom Bose gases with tunable interactions. 2011. *Physical Review A*. 84: 023603.
- Mihaila, B., J. F. Dawson, F. Cooper, C. C. Chien, and E. Tim-

mermans. Auxiliary field formalism for dilute fermionic atom gases with tunable interactions. 2011. Physical Review A. 83: 053637.

Velizhanin, K. A., C. C. Chien, Y. Dubi, and M. Zwolak. Driving denaturation: Nanoscale thermal transport as a probe of DNA melting. 2011. Physical Review E. 83: 050906.

Wulin, D., B. M. Fregoso, H. Guo, C. C. Chien, and K. Levin. Conductivity in Pseudogapped Superconductors: The Role of the Fermi Arcs. 2011. Physical Review B. 84: 140509.

Wulin, D., H. Guo, C. C. Chien, and K. Levin. Spin Transport in Cold Fermi gases: A Pseudogap Interpretation of Spin Diffusion Experiments at Unitarity . 2011. Physical Review A. 83: 061601.

Wulin, D., H. Guo, C. C. Chien, and K. Levin. Two-component optical conductivity in the cuprates: A necessary consequence of preformed pairs . 2012. Physical Review B. 86: 134518.

Multiferroic Magnetolectric Hybrid Inorganic-Organic Frameworks

Michael R. Fitzsimmons
20110716PRD2

Abstract

Metal-organic-frameworks are crystalline compounds consisting of metal atoms or clusters coordinated to organic ligands with extended structure in at least one direction. A unique potential of metal-organic-frameworks is to exhibit combinations of properties that might not be possible in purely inorganic and organic systems. This potential is realized by tailoring the polymeric ligand structures comprising the framework and the metal ion captured inside the framework that allowed us to circumnavigate the mutually exclusive problem of achieving ferromagnetism and ferroelectricity in a single inorganic compound. We have studied structurally disordered metal-organic-frameworks which upon application of an external stimulus, i.e. temperature or pressure, result in a polar-ordered structure and ferroelectric behavior. Magnetic transition metals have been used to achieve simultaneous ferromagnetic ordering. A number of known structures have also been studied and optimized. Our work has resulted into new multiferroic materials exhibiting a strong magnetolectric effect opening up a new class of materials with these highly sought after properties (Figure 1).

Background and Research Objectives

The goal of this work was to discover new multiferroic materials, exhibiting a strong magnetolectric effect by tailoring the metal-organic-framework structures. In a field dominated by materials that contain the toxic element lead, metal-organic-frameworks present new opportunities for the production of lead-free (i.e., green) multiferroic compounds customized for specific technological applications, including but not limited to data storage, photo-voltaic, sensors, and transducers. Devices using multiferroic behavior will be faster, smaller and more sensitive to their environment than present technology. New applications include: secure communication achieved by changing frequencies used to broadcast information in real-time, and the detection of steel moving under the ocean's surface.

Scientific Approach and Accomplishments

The main goal of this project of this project is the realization of giant coupling between magnetism and electric polarization in metal-organic-frameworks (MOFs) or hybrid inorganic-organic materials. This coupling is a much sought- after property necessary to satisfy the ever growing need for better data storage media and other functional properties otherwise not possible.

Metal-organic-frameworks are crystalline materials consisting of metal atoms or clusters coordinated to organic ligands with extended structure in at least one direction. A unique potential of metal-organic-frameworks is to exhibit combinations of properties that might not be possible in purely inorganic and organic systems. This potential is realized by tailoring the polymeric ligand structures comprising the framework and the metal ion captured inside the framework to allow us to circumnavigate the mutually exclusive problem of achieving ferromagnetism and ferroelectricity in a single inorganic compound. We accomplished this in $(\text{CH}_3)_2\text{CH}_2\text{Mn}(\text{HCOO})_3$ a manganese formate framework in which Mn atoms are bridged together by the most basic carboxylate ligand formic acid. This framework contains disordered organic cations in the pores. It is the ordering of these cations that leads to net electric polarization in this material below 180K. Due the paramagnetic nature of the materials the magnitude of electric polarization can be enhanced by an applied magnetic field (Figure 1). This is an important breakthrough given that ferroelectricity and ferromagnetism are usually two mutually exclusive properties in a single phase material. In addition, we have made several key contributions to understanding the nature of coupling in these novel hybrid materials which will pave the way to develop even stronger room temperature magnetolectric coupling, shown by our refereed journal articles. 1-6

In addition to the published work we have four additional manuscripts in preparation related to the above-mentioned achievements.

Impact on National Missions

Devices using multiferroic behavior will be faster, smaller and more sensitive to their environment than present technology. New applications include: secure communication achieved by changing frequencies used to broadcast information in real-time, and the detection of steel moving under the ocean's surface. Room temperature magneto-electric multiferroic materials can drastically improve our current technological capabilities across the spectrum of applications while adding new capabilities at the same time. Specifically, understanding the room temperature coupling between ferromagnetism and ferroelectricity is identified in the section of "Collective Phenomena" in Basic Energy Science's Grand Challenge: "Complex Systems: Science for the 21st Century". We have explored how tailoring ligand structures in metal-organic frameworks at nanometer length scales promotes coupling of ferromagnetism and ferroelectricity. This effort is directly relevant to BES's Grand Challenge: "Nanoscale Science, Engineering and Technology Research Directions"-- namely to the effort in enhancing functionality through nanoengineering.

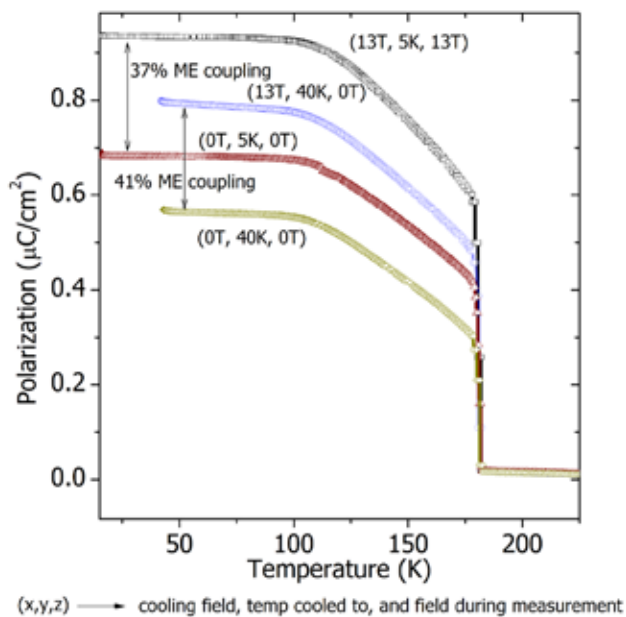

Figure 1. Polarization measured as a function of temperature and field. Sample exhibits dramatic magneto-electric coupling.

References

1. Zhenxing, W.. Unknown. 2013. Physical Review B. 87: 224406.
2. Stroppa, A., P. Barone, P. Jain, J. M. Perez-Mato, and S.

Picozzi. Hybrid Improper Ferroelectricity in a Multiferroic and Magnetolectric Metal-Organic Framework. 2013. ADVANCED MATERIALS. 25 (16): 2284.

3. Li, W., Z. Y. Zhang, E. G. Bithell, A. S. Batsanov, P. T. Barton, P. J. Saines, P. Jain, C. J. Howard, M. A. Carpenter, and A. K. Cheetham. Ferroelasticity in a metal-organic framework perovskite; towards a new class of multiferroics. 2013. ACTA MATERIALIA. 61 (13): 4928.
4. Sante, D. Di, A. Stroppa, P. Jain, and S. Picozzi. Tuning the Ferroelectric Polarization in a Multiferroic Metal-Organic Framework. 2013. JOURNAL OF THE AMERICAN CHEMICAL SOCIETY. 135 (48): 18126.
5. Thomson, R. I., P. Jain, A. K. Cheetham, and M. A. Carpenter. Elastic relaxation behavior, magnetoelastic coupling, and order-disorder processes in multiferroic metal-organic frameworks. 2012. PHYSICAL REVIEW B. 86 (21): -.
6. Tan, J. C., P. Jain, and A. K. Cheetham. Influence of ligand field stabilization energy on the elastic properties of multiferroic MOFs with the perovskite architecture. 2012. DALTON TRANSACTIONS. 41 (14): 3949.

Publications

Li, W., Z. Zhang, E. Bithell, A. Batsanov, P. Barton, P. Saines, P. Jain, C. Howard, M. Carpenter, and A. Cheetham. Ferroelasticity in a metal-organic framework perovskite; towards a new class of multiferroics. 2013. Acta Materialia. 61: 4928.

Ratcliff, W., J. W. Lynn, V. Kiryukhin, P. Jain, and M. R. Fitzsimmons. Magnetic structures and dynamics of multiferroic systems obtained with neutron scattering. Multiferroic materials. Edited by Martin, L., and R. Ramesh.

Sante, D. Di, A. Stroppa, P. Jain, and S. Picozzi. Tuning the Ferroelectric Polarization in a Multiferroic Metal-Organic Framework. 2013. JOURNAL OF THE AMERICAN CHEMICAL SOCIETY. 135 (48): 18126.

Stroppa, A., P. Barone, P. Jain, J. M. Perez-Mato, and S. Picozzi. Hybrid Improper Ferroelectricity in a Multiferroic and Magnetolectric Metal-Organic Framework. 2013. Advanced Materials. 25: 2284.

Tan, J., P. Jain, and A. Cheetham. Influence of ligand field stabilization energy on the elastic properties of multiferroic MOFs with the perovskite architecture. 2012. Dalton Transactions. 41: 3949.

Thomson, R. I., P. Jain, A. K. Cheetham, and M. A. Carpenter. Elastic relaxation behavior, magnetoelastic coupling, and order-disorder processes in multiferroic

metal-organic frameworks. 2012. Physical Review B. 86.

Wang, Z., P. Jain, K. Choi, J. van Tol, A. Cheetham, H. Kroto, H. Koo, H. Zhou, J. Hwang, E. S. Choi, M. Whangbo, and N. Dalal. Dimethylammonium copper formate (CH₃)₂NH₂ Cu(HCOO)₃: A metal-organic framework with quasi-one-dimensional antiferromagnetism and magnetostriction. 2013. Physical Review B. 87.

Zhenxing, W.. Unknown. 2013. PRB. 87: 224406.

Probing the Structure of Superconducting States with Rotating Magnetic Fields

Roman Movshovich
20110748PRD3

Abstract

The heavy fermion phenomenon is one of the most striking examples of strong electronic correlations. Conventional superconductivity is mediated by lattice phonons, and electrons combine into Cooper pairs with both total spin and orbital angular momentum of zero (*s*-wave), i.e., the whole Fermi surface is gapped. In several classes of superconductors, such as Heavy Fermion Superconductors (HFS) and High Temperature Superconductors (HTS), superconductivity is believed to be unconventional, where the symmetry of the superconducting order parameter is lower than that of the underlying crystal lattice. For example, most of the HTS compounds were shown to have $d_{x^2-y^2}$ symmetry of the order parameter. This symmetry was identified via phase sensitive experiments based on Josephson tunneling, using corner junctions Superconducting Quantum Interference Devices (SQUIDS). There are many indications that superconductivity in HFS is also unconventional. In fact, the first superconductors unambiguously shown to be unconventional were the heavy fermions UPt₃ and UBe₁₃, which exhibited multiple superconducting phases (*s*-wave superconductors are single phase). It is widely believed that superconductivity in HFS is mediated by magnetic fluctuations provided by spins of the *f*-electrons of U, Pu, or Ce ions. Discovered at LANL, PuCoGa₅, with superconducting transition temperature $T_c = 18\text{K}$, together with a related family of other Pu-based superconductors, provides a link between the HFS and HTS compounds, both in terms of transition temperature and the likely microscopic mechanism of superconductivity. So far, there have been no successful phase sensitive measurements performed on HFS materials, presumably due to device fabrication and materials' surface difficulties. However, a different set of powerful tools to probe the superconducting gap structure is emerging, namely that of specific heat and thermal transport measurements in rotating magnetic fields. The development of these capabilities in a dilution refrigerator equipped with a horizontal-axis rotator insert and a superconducting

magnet, thereby spanning the B-T phase diagram down to 20 mK and up to 14 Tesla, was at the core of this project. When completed, this will be a unique facility worldwide, that will take the current state-of-the-art of experiments to much lower temperatures and higher fields, and will lead to new discoveries in the uncharted territories of the superconducting phase diagram. Opening this phase space to experimental investigations will allow us to perform critical tests of existing theories of unconventional superconductivity in magnetic fields, which are instrumental for our understanding and the interpretation of experiments.

Background and Research Objectives

Heavy Fermion systems (HFSs) are excellent model systems to study the rich variety of strong correlations in electron systems, such as quantum criticality or superconductivity (SC). In contrast to the well understood phonon-mediated SC in the majority of the pure elements, with isotropic energy gap over the entire Fermi surface, SC in HFSs is unconventional, and the order parameter (OP) has lower symmetry than the underlying crystal lattice. Despite the huge experimental and theoretical effort in the last 30 years, the mechanism leading to SC in HFSs is still largely unknown, and only solved in few rare systems. The knowledge of the symmetry of the OP plays an important role in understanding superconductivity, because it restricts the class of potential microscopic underlying mechanisms. In another family of strongly-correlated electron systems, the high temperature superconductors, this experimental question was addressed successfully by phase sensitive Josephson tunnelling spectroscopy. Due to the difficulties in device fabrication and surface preparation, these experimental tools up to date were largely not employed for HFSs. An equivalent powerful tool to identify unambiguous the symmetry of the OP is the combination of thermal conductivity and heat capacity measurements in rotating magnetic fields with sophisticated theoretical model calculations. The objective of this project was to develop

the capability to perform the thermal conductivity and heat capacity in rotating magnetic fields.

Scientific Approach and Accomplishments

Dr. Weickert used a number of experimental techniques to investigate correlated electron materials, including heavy fermion compounds, quantum magnets, and unconventional superconductors. Her main research objective was investigation of unconventional superconductors in rotating magnetic field at dilution refrigerator temperatures. Original idea was to use a mechanical rotator supplied by Oxford Instruments as one of the inserts for their dilution refrigerator system. Dr. Weickert explored the feasibility of using that rotator for specific heat measurements, and determined that the large amount of heating generated by the mechanical rotator makes the time required to cool the cell back to temperature of interest prohibitively large. She then initiated the purchase of the Piezoelectrics – based rotator from Attocube, and designed and built the support stage. She also designed modifications for the standard insert for the dilution refrigerator to accommodate the low resistance and high voltage requirements on the electrical leads used for operation of the Attocube rotator. She is building the thermal conductivity cell for this rotator, and fabricating and calibrating thermometers for this cell.

On the technical front Dr. Weickert championed the development (from scratch) of a modified relaxation calorimetry technique, particularly suited to measuring specific heat in radioactive samples as well as general samples with small specific heat. This project involved modeling the thermal behavior of a complete cell consisting of the platform with a heater, sample, and thermometer, and solving and understanding in detail the behavior of various components and heat flow between them. It also required assembly of measuring equipment and electronic components, and writing and integrating components of the Labview code, as well as making changes to the cryostat grounding and shielding to improve the signal-to-noise; basically taking care of all small details that bring big benefits in a very low temperature small signal environment. The relaxation calorimetry cell was used to successfully measure specific heat of high purity UPt₃ sample (with the mass of about 1 mg), as well as the background specific heat of our cell (with specific heat of a fraction of a nJ/K), down to below 30 mK.

Dr. Weickert has also improved the Labview code used to control heat capacity measurement capability that utilizes a quasi-adiabatic method, and used it over the last two months to perform measurements on several quantum magnets systems, including Pr₃Pd₂₀Si₆, BaNd₂O₄, and BaTb₂O₄.

Overall Dr. Weickert published 16 papers during her

postdoctoral tenure at LANL, both with LANL and external collaborators. Of particular note is her work on fully-gapped superconductivity in co-doped Fe-based pnictide 122 superconductor[1,2] and her extensive work on the so-called DTN quantum magnet system [3-6].

Impact on National Missions

Dr. Weickert's development of the modified relaxation calorimetry specific heat measurement allows us now to measure very small samples with higher precision and to lower temperatures, crucial for research in correlated electron materials, and particularly unconventional superconductivity, as the superconducting samples' specific heat decreases either power law or exponentially as a function of temperature. This method is particularly useful for measuring radioactive samples, as in a standard relaxation calorimetry setup the heat generated by the sample flows between the sample and thermometer, and then to a thermal bath. This fundamentally leads to a temperature difference between the sample and the thermometer, clearly a problem for a measurement based on thermometry. The piezoelectric rotator, in a low temperature-high field environment will be a powerful method that will allow us to establish the symmetry and structure of the energy-gap in any superconducting material and opens a wide door for fundamental investigations of new classes of superconductors of currently high interest and visibility, like iron-based arsenides or Sr₂RuO₄.

On top of it, specific heat is a true thermodynamic quantity and directly linked to the entropy and free energy of a system. The capabilities described above are extraordinary tools to be involved in other potentially interesting areas of research of strongly correlated electron systems as well.

References

1. Weickert, F., M. Nicklas, W. Schnelle, J. Wosnitza, A. Leithe-Jasper, and H. Rosner. Enhancement of the upper critical field in codoped iron-arsenic high-temperature superconductors. 2011. JOURNAL OF APPLIED PHYSICS. 110 (12): -.
2. Gofryk, K., J. C. Lashley, F. Ronning, D. J. Safarik, F. Weickert, J. L. Smith, A. Leithe-Jasper, W. Schnelle, M. Nicklas, and H. Rosner. Fully-gapped superconductivity in Ba_{0.55}K_{0.45}Fe_{1.95}Co_{0.05}As₂: A low-temperature specific heat study. 2012. PHYSICAL REVIEW B. 85 (22): -.
3. Yu, R., C. F. Miclea, F. Weickert, R. Movshovich, A. Paduan, V. S. Zapf, and T. Roscilde. Quantum critical scaling at a Bose-glass/superfluid transition: Theory and experiment for a model quantum magnet. 2012. PHYSICAL REVIEW B. 86 (13): -.

4. Yu, R., L. Yin, N. S. Sullivan, J. S. Xia, C. Huan, A. Paduan, N. F. Oliveira, S. Haas, A. Steppke, C. F. Miclea, F. Weickert, R. Movshovich, E. D. Mun, B. L. Scott, V. S. Zapf, and T. Roscilde. Bose glass and Mott glass of quasiparticles in a doped quantum magnet. 2012. NATURE. 489 (7416): 379.
5. Weickert, F., R. Kuchler, A. Steppke, L. Pedrero, M. Nicklas, M. Brando, F. Steglich, M. Jaime, V. S. Zapf, A. Paduan, K. A. Al-Hassanieh, C. D. Batista, and P. Sengupta. Low-temperature thermodynamic properties near the field-induced quantum critical point in NiCl₂-4SC(NH₂)(2). 2012. PHYSICAL REVIEW B. 85 (18): -.
6. Weickert, F., R. Kuchler, A. Steppke, L. Pedrero, M. Nicklas, M. Brando, F. Steglich, M. Jaime, V. S. Zapf, A. Paduan, K. A. Al-Hassanieh, C. D. Batista, and P. Sengupta. Low-temperature thermodynamic properties near the field-induced quantum critical point in NiCl₂-4SC(NH₂)(2). 2012. PHYSICAL REVIEW B. 85 (18): -.

Publications

- Daou, R., A. Haase, M. Doerr, M. Rotter, F. Weickert, M. Nicklas, and F. Steglich. Magnetoelastic quantum oscillations in GdSb to 55 T. 2011. In International Conference on Strongly Correlated Electron Systems (SCES 2010) ; 27 June-2 July 2010 ; Santa Fe, NM, USA. Vol. 273, p. 012111 (4 pp.).
- Deppe, M., S. Lausberg, F. Weickert, M. Brando, Y. Skouriski, N. Caroca-Canales, C. Geibel, and F. Steglich. Pronounced first-order metamagnetic transition in the paramagnetic heavy-fermion system CeTiGe. 2012. PHYSICAL REVIEW B. 85 (6): 060401.
- Gofryk, K., J. C. Lashley, F. Ronning, D. J. Safarik, F. Weickert, J. L. Smith, A. Leithe-Jasper, W. Schnelle, M. Nicklas, and H. Rosner. Fully-gapped superconductivity in Ba_{0.55}K_{0.45}Fe_{1.95}Co_{0.05}As₂: A low-temperature specific heat study. 2012. PHYSICAL REVIEW B. 85 (22): 224504.
- Jaime, M., R. Daou, S. Crooker, F. Weickert, A. Uchida, A. Feiguin, C. Batista, H. Dabkowska, and B. Gaulin. Magnetostriction and magnetic texture to 100.75 Tesla in frustrated SrCu₂(BO₃)(2). 2012. PROCEEDINGS OF THE NATIONAL ACADEMY OF SCIENCES OF THE UNITED STATES OF AMERICA. 109 (31): 12404.
- Janson, O., A. A. Tsirlin, J. Sichelschmidt, Y. Skourski, F. Weickert, and H. Rosner. Long-range superexchange in Cu₂A₂O₇ (A= P, As, V) as a key element of the microscopic magnetic model. 2011. Physical Review B (Condensed Matter and Materials Physics). 83 (9): 094435 (7 pp.).
- Janson, O., A. A. Tsirlin, J. Sichelschmidt, Y. Skourski, F. Weickert, and H. Rosner. Long-range superexchange in Cu₂A₂O₇ (A= P, As, V) as a key element of the microscopic magnetic model. 2011. Physical Review B (Condensed Matter and Materials Physics). 83 (9): 094435 (7 pp.).
- Tsirlin, A., I. Rousochatzakis, D. Kasinathan, O. Janson, R. Nath, F. Weickert, C. Geibel, A. Lauchli, and H. Rosner. Bridging frustrated-spin-chain and spin-ladder physics: Quasi-one-dimensional magnetism of BiCu₂PO₆. 2010. PHYSICAL REVIEW B. 82 (14): 144426.
- Weickert, F., B. Meier, S. Zherlitsyn, Herrmannsdorfer, R. Daou, M. Nicklas, J. Haase, F. Steglich, and J. Wosnitza. Implementation of specific-heat and NMR experiments in the 1500 ms long-pulse magnet at the Hochfeld-Magnetlabor Dresden. 2012. Measurement Science & Technology. 23 (10): 105001 (9 pp.).
- Weickert, F., B. Meier, S. Zherlitsyn, T. Herrmannsdorfer, R. Daou, M. Nicklas, J. Haase, F. Steglich, and J. Wosnitza. Implementation of specific-heat and NMR experiments in the 1500 ms long-pulse magnet at the Hochfeld-Magnetlabor Dresden. 2012. MEASUREMENT SCIENCE & TECHNOLOGY. 23 (10): 105001.
- Weickert, F., M. Nicklas, W. Schnelle, J. Wosnitza, A. Leithe-Jasper, and H. Rosner. Enhancement of the upper critical field in codoped iron-arsenic high-temperature superconductors. 2011. Journal of Applied Physics. 110 (12): 123906.
- Weickert, F., R. Kuchler, A. Steppke, L. Pedrero, M. Nicklas, M. Brando, F. Steglich, M. Jaime, V. Zapf, A. Paduan, K. Al-Hassanieh, C. Batista, and P. Sengupta. Low-temperature thermodynamic properties near the field-induced quantum critical point in NiCl₂-4SC(NH₂)(2). 2012. PHYSICAL REVIEW B. 85 (18): 184408.
- Weickert, F., R. Kuchler, V. Zapf, M. Jaime, and A. Paduan-Filho. Direct measurement of spin correlations using magnetostriction (vol 77, 020404, 2008). 2011. PHYSICAL REVIEW B. 83 (9): 099901.
- Yu, R., C. Miclea, F. Weickert, R. Movshovich, A. Paduan-Filho, V. Zapf, and T. Roscilde. Quantum critical scaling at a Bose-glass/superfluid transition: Theory and experiment for a model quantum magnet. 2012. Physical Review B. 86 (13): 134421.
- Yu, Rong, Liang Yin, N. Sullivan, J. S. Xia, Chao Huan, A. Paduan-Filho, N. Oliveira, S. Haas, A. Steppke, C. Miclea, F. Weickert, R. Movshovich, Eun-Deok Mun, B. Scott, V. Zapf, and T. Roscilde. Bose glass and Mott glass of quasiparticles in a doped quantum magnet. 2012. Nature. 489 (7416): 379.

Direct Tracking of Charge Carriers in Heterostructured Nanowires

Rohit P. Prasankumar
20110753PRD4

Abstract

Silicon nanowires (SiNWs) have attracted much attention because of their great potential for nanophotonic and nanoelectronic applications. These quasi-one-dimensional (1D) nanosystems have unique properties that depend on their size, shape, and alignment. While time-integrated and time-resolved photoluminescence (PL) experiments have given some insight into the influence of these parameters on NW properties, these measurements have not had sufficient time resolution to resolve several important carrier relaxation processes in these systems, including electron-phonon coupling and inter/intravalley scattering. Therefore, there remains a lack of basic understanding of how light interacts with individual NWs on an ultrashort time scale, which is critical to fully realize their promise for various applications. Furthermore, to date, inhomogeneities in NW ensembles have made it difficult to unambiguously extract their underlying physics.

In this project, by isolating individual nanowires, we avoid complications resulting from the broad size and alignment distribution in nanowire ensembles, allowing us to use ultrafast optical microscopy to directly examine carrier dynamics and carrier velocities in single NWs with high temporal and spatial resolution in a non-contact manner. Moreover, we proposed to use a hybrid NW-nanoantenna structure in a terahertz (THz)-pump, optical-probe experiment to generate THz field strengths on the order of tens to hundreds of kV/cm at the antenna focus. This would enable us to directly initiate transient electron dynamics, allowing us to monitor the resulting carrier populations with ultrafast time resolution and observe novel phenomena such as the dynamic Franz-Keldysh effect.

The ultrafast optical experiments described here thus open pathways to directly study carrier dynamics and charge transport in quasi-1D nanosystems. This research has potential application to NW-based devices, opto-

electronics, and sensitive photodetection on both the nanoscale and ultrashort time scales, which will contribute to institutional efforts in nanoscience at LANL.

Background and Research Objectives

An understanding of carrier dynamics in semiconductor nanowires (NWs) is attractive for a variety of potential electronic and optoelectronic applications, including photodetectors, electrically-driven lasers, nanoscale transistors, and solar cells. In particular, recent success in the fabrication of axial and radial NW heterostructures composed of one or more layers with different properties has enabled greater control of device operation for optoelectronics and solar cells. Since interfaces between different layers in heterostructured NWs strongly influence their properties and in turn device performance, it is important to observe carrier transport across interfaces in these quasi-1D systems.

The main goal of this work was to use ultrafast optical microscopy to examine carrier dynamics and carrier velocities directly in NW heterostructures, both through individual layers and across interfaces, with high temporal and spatial resolution in a non-contact manner. By photoexciting carriers at a specific position on the NW and varying the probe position, we could track electron and hole relaxation processes as these carriers propagate along the NW. Carrier velocities could then be extracted from the measured population at each position and the time taken for carriers to travel between points that are separated by a known distance. By tuning the pump and probe wavelengths in radially heterostructured NWs and by photoexciting only one material in axially heterostructured NWs, we could determine carrier velocities in the core/shell layers and understand carrier transport, respectively.

Moreover, to selectively track only electron dynamics in these NWs, we formulated the idea of using a hybrid NW-nanoantenna structure in a terahertz (THz)-pump,

optical-probe experiment. Since the NW volume is extremely small compared to the THz wavelength, an antenna structure is needed to enhance the THz field strength to produce a measurable signal level. While typical optical-pump/optical-probe experiments investigate both hole and electron dynamics created simultaneously using band-to-band photoexcitation, THz field strengths on the order of tens of kV/cm can directly photoexcite transient electron dynamics, which would allow us to monitor the resulting temporal evolution with ultrafast time resolution. This would then potentially enable us to observe novel phenomena such as the dynamic Franz-Keldysh effect, where a time-varying intense THz electric field can modify the band structure, as probed with an optical pulse tuned near the conduction band edge.

Scientific Approach and Accomplishments

In the first year of this project, we developed the technique of ultrafast optical microscopy (UOM), allowing us to track charge carriers through space and time in single semiconductor nanowires with high space and time resolution. Our first experiments demonstrated this capability on isolated Si nanowires (NWs), providing new insight into light-matter interactions in quasi-1D nanosystems that is unattainable from ensemble studies. Through performing polarization-and-spatially-resolved ultrafast optical spectroscopy, we demonstrated that carrier relaxation in single Si NWs is primarily governed by surface-mediated mechanisms and Auger recombination, with their relative importance depending on the NW size and morphology as well as the polarization and intensity of the incident light (Figure 1). Furthermore, our time-resolved optical experiments also enabled us to accurately extract device-relevant parameters such as the diffusion length and surface recombination velocity in a non-contact manner, which can be directly compared to known values from electrical contact-based methods. This work was published in *Applied Physics Letters* early last year [1].

Subsequently, by upgrading the spatial resolution of our system using high numerical aperture microscopic objectives, we could measure the time-resolved photoinduced change in transmission at a specific position (proportional to the carrier population at that point). Then, by varying the pump and probe positions along the NW axis relative to one another, we could measure carrier relaxation and track the carrier diffusion current along the NW at ultra-short time scales (Figure 2). A substantial difference was observed in these quantities for semiconductor nanowires with and without a “shell” (a thin layer grown in the radial direction on the semiconductor core); “bare” NWs exhibited much faster carrier relaxation due to carrier trapping in surface states, while the growth of a shell passivated

these states and enabled carriers to propagate for much longer distances along the NW axis. This in turn enabled us to map space-and-time-dependent carrier dynamics in core/shell NWs, revealing strong acoustic phonon oscillations, and allowed us to directly map the axial diffusion current in different NWs. Importantly, these results essentially correspond to a “textbook” case of carrier diffusion in one dimension after impulsive excitation, which could not be previously observed using conventional contact-based methods for studying minority carrier transport in semiconductors, such as scanning photocurrent microscopy (SPCM) or electron-beam-induced current (EBIC) analysis. This work was published in *Nano Letters* late last year [2].

In the last year of this project, we developed a two-dimensional (2D) smart pixel detector to create an ultrafast optical wide field microscope (UOWFM), capable of rapidly acquiring wide field microscopic images with high temporal- and spatial-resolution. As compared to most optical microscopy measurements, which are nearly always performed in a time-integrated mode, our ultrashort pulsed laser-based technique provides femtosecond temporal resolution over a broad energy range. This is realized by combining wide field optical microscopy and ultrafast optical spectroscopy.

As a first step, we acquired time-resolved images of a gold-patterned amorphous silicon film and a single silicon nanowire (NW) to demonstrate the validity of this novel concept. Two different femtosecond laser systems were used to study these different samples, demonstrating the versatility of our approach. In both cases, we used a unique 2D smart pixel detector array (provided by Heliotis AG) with a 50X (0.50 NA) objective and a zoom lens with variable magnification to image these materials. This 2D array detector performs with sensitivity comparable or better to that of a conventional single pixel detector in these experiments, which allows our UOWFM system to behave like a ‘lock-in’ camera; essentially, this technique allows one to “look” through an optical microscope with extremely high time resolution. The time-resolved optical images of a single Si NW acquired using UOWFM thus provided valuable insight into carrier dynamics with sub-micron optical resolution, while time-resolved images of a patterned Si film (Figure 3) demonstrated our ability to capture information over a large area within a short acquisition time. Importantly, our nanowire imaging results show that our technique works for very small targets with sub-micron spatial resolution, which should be very helpful for nanomaterials research, particularly given the rapid image acquisition time. This work was published in *Optics Express* earlier this year [3].

Overall, ultrafast optical wide field microscopy combines

the non-contact nature and spatial resolution of conventional optical microscopy with the temporal resolution of ultrafast spectroscopy to rapidly and sensitively acquire spatially and temporally resolved images of nearly any sample. Furthermore, ultrafast optical wide field microscopy can, in principle, be used to acquire time-varying images of almost any material that can be imaged with a conventional optical microscope, and can thus be expected to have many future applications in a variety of physical, chemical, and biological systems.

Finally, in pursuit of the goal of selectively photoexciting and tracking electron dynamics in single Si NWs, we built a time-domain terahertz (THz)-probe spectroscopy system, based on an amplified 1 kHz laser, and designed a special hybrid plasmonic NW-nanoantenna device structure that will enable us to study the response of individual semiconductor NWs after both optical and THz photoexcitation. This THz nonlinear spectroscopy capability can be applied to a wide range of problems in photonics and electronics, advancing both fundamental science while potentially impacting engineering applications. Dr. Seo was selected for a position at the Korea Institute of Science and Technology, which prevented us from pursuing these directions further although it was clearly a positive outcome for her. We expect to continue exploring these directions in the near future, likely in collaboration with Dr. Seo.

Impact on National Missions

This research has developed the new capability of ultrafast optical microscopy, which is a general technique that can be applied nearly any biological, chemical, or physical system. The generality of this technique therefore makes it quite interesting to several programs within the DOE Office of Science, and could also appeal to other programs within DOE, DOD, NIH, and NIST. In addition, the understanding of carrier transport across interfaces in nanowires gained here will have a significant impact on solar cell and solid-state lighting applications, as well as the use of these nanowires as high speed nanoscale transistors. Finally, the goals of this project align well with the “Basic Understanding of Materials” mission, and to a lesser extent, the “Renewable Energy” mission at LANL.

Our future work will include further optimizing the 2D array detector for this unique application and applying this technique to track space and time varying processes in a variety of systems. This will contribute to LANL’s leadership in nanoscience and nanotechnology while supporting the collaboration between LANL and Sandia National Labs (through the Center for Integrated Nanotechnologies). Finally, this forefront science and capability development will attract high quality staff and collaborators to LANL.

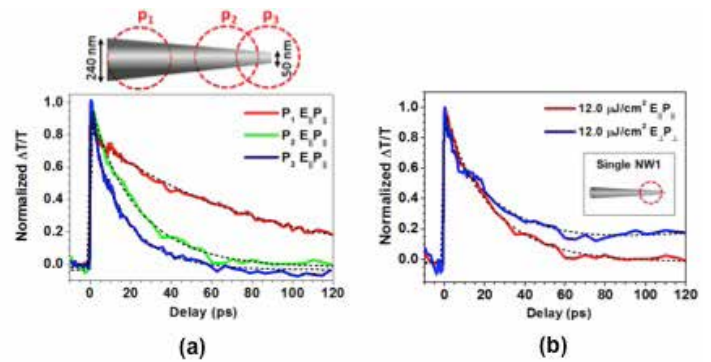

Figure 1. (a) Position and (b) polarization-resolved carrier dynamics in a single Si NW.

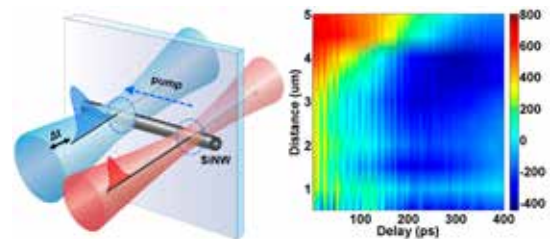

Figure 2. (a) Schematic of our ultrafast optical microscopy experiment. (b) Two-dimensional diffusion current map for a Si/SiO₂ core/shell NW.

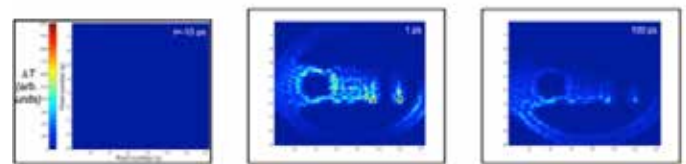

Figure 3. UOWFM images of a patterned amorphous Si film at different time delays.

References

- Seo, M. A., S. A. Dayeh, P. C. Upadhyaya, J. A. Martinez, B. S. Swartzentruber, S. T. Picraux, A. J. Taylor, and R. P. Prasankumar. Understanding ultrafast carrier dynamics in single quasi-one-dimensional Si nanowires. 2012. APPLIED PHYSICS LETTERS. 100 (7): 071104.
- Seo, M. A., J. Yoo, S. A. Dayeh, S. T. Picraux, A. J. Taylor, and R. P. Prasankumar. Mapping carrier diffusion in single silicon core-shell nanowires with ultrafast optical microscopy. 2012. Nano Letters. 12: 6334.
- Seo, M. A., S. Boubanga-Tombet, J. Yoo, Z. Ku, A. V. Gin, S. T. Picraux, S. R. J. Brueck, A. J. Taylor, and R. P. Prasankumar. Ultrafast optical wide field microscopy. 2013. Optics Express. 21: 8763.

Publications

- Prasankumar, R. P.. Tracking charge carriers through space and time in single semiconductor nanowires. Invited presentation at CINT User Workshop. (Albuquerque, 19-20 September 2012).
- Prasankumar, R. P.. Tracking charge carriers through space and time in single semiconductor nanowires. Invited presentation at SSL EFRC coffee hour. (Albuquerque, 14 June 2012).
- Seo, M. A., J. Yoo, D. E. Perea, S. A. Dayeh, S. T. Picraux, A. J. Taylor, and R. P. Prasankumar. Tracking ultrafast carrier dynamics in single semiconductor nanowire heterostructures. 2013. In 18th International Conference on Ultrafast Phenomena. (Lausanne, Switzerland, 8-13 July 2012). , p. 4030. London: Oxford University Press.
- Seo, M. A., J. Yoo, S. A. Dayeh, S. T. Picraux, A. J. Taylor, and R. P. Prasankumar. Mapping carrier diffusion in single silicon core-shell nanowires with ultrafast optical microscopy. 2012. *Nano Letters*. 12: 6334.
- Seo, M. A., J. Yoo, S. A. Dayeh, S. T. Picraux, A. J. Taylor, and R. P. Prasankumar. Tracking charge carriers through space and time in single semiconductor nanowires. Presented at Conference on Lasers and Electro-Optics. (San Jose, CA, 6-11 May, 2012).
- Seo, M. A., J. Yoo, S. A. Dayeh, S. T. Picraux, A. J. Taylor, and R. P. Prasankumar. Mapping carrier diffusion in single silicon core-shell nanowires with ultrafast optical microscopy. 2013. In 7th International Conference on Materials for Advanced Technologies. (Singapore, 30th June-5th July, 2013). Vol. 8, p. 128. Singapore: World Scientific.
- Seo, M. A., S. A. Dayeh, P. C. Upadhyaya, J. A. Martinez, B. S. Swartzentruber, S. T. Picraux, A. J. Taylor, and R. P. Prasankumar. Understanding ultrafast carrier dynamics in single quasi-one-dimensional Si nanowires. 2012. *APPLIED PHYSICS LETTERS*. 100 (7): 071104.
- Seo, M. A., S. A. Dayeh, P. C. Upadhyaya, S. T. Picraux, J. Martinez, B. S. Swartzentruber, A. J. Taylor, R. P. Prasankumar, and IEEE. Polarization anisotropy of transient carrier dynamics in single Si nanowires. 2011. In Conference on Lasers and Electro-Optics (CLEO) ; 20110501 - 20110506 ; Baltimore, MD.
- Seo, M. A., S. Boubanga-Tombet, J. Yoo, Z. Ku, A. V. Gin, S. T. Picraux, S. R. J. Brueck, A. J. Taylor, and R. P. Prasankumar. Ultrafast optical wide field microscopy. 2013. *Optics Express*. 21: 8763.

Investigation of the Electronic Structure of Heavy Fermions using ARPES and Tr-ARPES

Tomasz Durakiewicz
20110754PRD4

Abstract

Recently, the world's first ultrafast pump-probe angle-resolved photoelectron spectroscopy (tr-ARPES) facility for f-electron research was constructed at LANL. This tool is ideally suited for ultrafast self-energy measurements due to the ability to directly measure the quasiparticle lifetime on a femtosecond timescale in a pump-probe setup. Such measurement is impossible with a usual, "static" ARPES. Dr Meng was able to build on the initial success and explore the nature of the heavy fermion state by utilizing tr-ARPES as a main research tool coupled with ARPES and many-body effective temperature modeling of the electronic structure. Dr. Meng focused on perhaps the most intriguing correlated case among uranium-based intermetallics, the hidden order system URu₂Si₂, and on the typical uranium – based heavy fermion material, UPd₂Al₃. Another aspect of the ultrafast dynamics was explored by Dr. Meng in USb₂, where he combined ARPES with ultrafast reflectivity, to unveil novel band renormalization mechanisms. This effort resulted in peer-reviewed publications over the last two years, including two papers in Physical Review Letters. The successful utilization of new experimental and theoretical capabilities for ultrafast self-energy extraction and dynamic spectral properties of coherent excitations in f-electron materials enhanced the expertise in materials design and characterization at LANL.

Background and Research Objectives

Exotic and unexpected physical properties, like unconventional superconductivity, the heavy fermion state, or the elusive "hidden order" phase of URu₂Si₂, emerge from many body interactions in f-electron systems. The perplexing mystery of the Hidden Order, a complex state achieved below 17.5K in URu₂Si₂, continues to attract attention of physicists worldwide. At the transition temperature URu₂Si₂ shows signs of ordering, with no indication of what the order parameter might be, hence the term "Hidden Order" was coined. The second system of interest, UPd₂A₃, is a heavy fermion system

with relatively large hybridization gap, where measuring the quasiparticle dynamics provides access to information about emergent electronic coherence. In the case of USb₂, a unique combination of ultrafast reflectivity and AREPS was used to visualize the strongly momentum-dependent and multiple band renormalization effects resulting from interactions of the electronic subsystem with both phonons and magnons. Dr. Meng, working with LANL team and international group of collaborators contributed to above questions mostly by combining two tools: time-resolved angle resolved photoemission (TR-ARPES) and synchrotron-based high resolution ARPES and utilizing ultrafast reflectivity in collaborative effort aimed at detailed temperature dependent studies of quasiparticle dynamics.

Scientific Approach and Accomplishments

The high resolution angle-resolved photoemission spectroscopy experiments performed by Dr. Meng were designed to probe deep into the hidden-order state of URu₂Si₂, utilizing tunable photon energies with sufficient energy and momentum resolution to detect the near Fermi-surface (FS) behavior. The results revealed (i) the full itinerancy of the 5f electrons, (ii) the crucial three-dimensional k-space nature of the FS and its critical nesting vectors, in good comparison with density-functional theory calculations, and (iii) the existence of hot-spot lines and pairing of states at the FS, leading to FS gapping in the hidden-order phase.

This work was published in Physical Review Letters. In an effort to understand the role of complex interactions between electrons, phonons and magnons, in forming the fine details of electronic band structure in USb₂, Dr. Meng used, in collaboration with LANL researchers, the ultrafast optical spectroscopy. Here it was observed that two charge gaps open at low temperatures (45 K), arising from renormalization of the electronic structure. Analysis of data indicated that one gap is due to hybridization between localized f-electron and conduc-

tion electron bands, while band renormalization involving magnons leads to the emergence of the second gap. This work, also published in *Physical Review Letters* and in *Journal of Electron Spectroscopy*, shed light on the complex electronic structure emerging at the Fermi surface in f-electron systems.

Impact on National Missions

This work relates directly to Basic Understanding of Materials through research of material properties with time - resolved and angle - resolved photoemission. It is also related to MaRIE by exploring the extreme ultrafast time-domain of quasiparticle dynamics in the investigated materials. The ultrafast research in connection with correlated materials research constitutes an important part of the current DOE/BES investment at LANL, and allows us to explore future funding opportunities.

Publications

Durakiewicz, T., P. Riseborough, and J. Q. Meng. Resolving the multi-gap electronic structure of USb₂ with interband self-energy. To appear in *Journal of Electron Spectroscopy and Related Phenomena*.

Meng, J. Q., P. M. Oppeneer, J. A. Mydosh, P. S. Riseborough, K. Gofryk, J. J. Joyce, E. D. Bauer, Y. W. Li, and T. Durakiewicz. Imaging the Three-Dimensional Fermi-Surface Pairing near the Hidden-Order Transition in URu₂Si₂ Using Angle-Resolved Photoemission Spectroscopy. 2013. *PHYSICAL REVIEW LETTERS*. 111 (12): -.

Meng, J., G. L. Dakovski, J. X. Zhu, P. S. Riseborough, G. Gu, S. M. Gilbertson, G. Rodriguez, and T. Durakiewicz. Time-resolved ARPES study of ultrafast dynamics in cuprate superconductor Bi₂212. 2012. In *APS March Meeting, 2012*. (Boston, MA, Feb 27 - March 2, 2012). , p. 312. Boston: APS MArch MEeting program.

Qi, J., T. Durakiewicz, S. A. Trugman, J. X. Zhu, P. S. Riseborough, R. Baumbach, E. D. Bauer, K. Gofryk, J. Q. Meng, J. J. Joyce, A. J. Taylor, and R. P. Prasankumar. Measurement of Two Low-Temperature Energy Gaps in the Electronic Structure of Antiferromagnetic USb₂ Using Ultrafast Optical Spectroscopy. 2013. *PHYSICAL REVIEW LETTERS*. 111 (5): -.

Zhang, W., J. M. Bok, J. H. Yun, J. He, G. Liu, L. Zhao, H. Liu, J. Meng, X. Jia, Y. Peng, D. Mou, S. Liu, S. He, X. Dong, J. Zhang, J. S. Wen, Z. J. Xu, G. D. Gu, G. Wang, Y. Zhu, X. Wang, Q. Peng, Z. Wang, S. Zhang, F. Yang, C. Chen, Z. Xu, H. Y. Choi, C. M. Varma, and X. J. Zhou. Extraction of normal electron self-energy and pairing self-energy in the superconducting state of the Bi₂Sr₂CaCu₂O₈ superconductor via laser-based angle-resolved photoemission. 2012. *Physical Review B*. 85 (6): 64514.

Fabrication of an All-Carbon Solar Cell

Andrew M. Dattelbaum

20120732PRD1

Abstract

This work aimed to explore the use of a new nanoscale material, graphene oxide, in clean energy applications, such as solar cells and fuel cells. We found that graphene oxide could be chemically modified to enhance its properties, in particular, for potential applications in hydrogen fuel cells. We prepared membranes of graphene oxide that were 20 microns (μm) thick and incorporated them into hydrogen/air fuel cells. We found that reacting the graphene oxide material with ozone (O_3) allowed us to prepare membranes with improved properties. Given the almost limitless pathways graphene oxide may be functionalized and its relatively easy preparation, we believe this work could lead to new carbon-based membranes for fuel cell as well as other applications.

Background and Research Objectives

Graphene oxide (GO) is formed by reacting oxygen with graphite. A schematic picture of graphene oxide is shown in Figure 1. GO consists of a single, atomic layer of carbon atoms that are bound to oxygen atoms. So, it is $\sim 1\text{nm}$ thick (z-directions), but can be hundreds of microns long (x and y directions), so you can imagine that GO looks like a flat rectangle. GO has some very interesting properties, which are being heavily investigated, which we described in a recent review article published during this LDRD project.¹ The GO flakes can be suspended in water and then filtered to form a thick ($\sim 20\mu\text{m}$) free standing membrane. We also know that these hydrogen atoms, i.e., protons, can move through the thick films, which makes these films ionic conductors. Ionic conductors are an important part of several clean energy producing devices, such as hydrogen fuel cells. For this project, we also took advantage of the chemical reactivity of GO, which is due, in part, to all the added oxygen atoms attached to the carbon backbone. Without these oxygen groups, the carbon backbone is stable (like graphite) and is hard to modify. We believed we could functionalize the graphene oxide while it was suspended in solution, then filter the functionalized

material to make a film to improve its ionic conducting properties. Such improvements should lead to a better membrane for fuel cell applications.

Scientific Approach and Accomplishments

We made free standing films of graphene oxide before and after exposure to ozone. We used ozone to increase the oxygen content on the carbon backbone, because the oxygen groups help with ionic conduction. In this case, more oxygen groups should lead to better ionic conduction properties. We characterized our materials by a variety of techniques including solid-state nuclear magnetic resonance (NMR), which can tell us how well our ozone reacted to GO. We also obtained images of GO and ozonated GO via transmission electron microscopy with atomic level resolution that showed significantly more oxygen atoms on the GO surface after exposure to ozone. We then tested the films in hydrogen/air fuel cells as schematically shown in Figure 2. We demonstrated that the fuel cells built around films exposed to ozone had improved properties compared to fuel cells built around GO films.

The enhancement in the ionic conductivity of the films after exposure to ozone likely originates from chemical structure and morphology changes in GO caused by ozonation. A higher content of oxygen containing functional groups on graphene should offer more hopping sites (conduction channels) for protons. We also observed a decrease in GO flake size and an increase in pinhole density in films made with GO exposed to ozone. The pinholes can afford additional pathways for proton hopping or diffusion through the bulk films, leading to higher protonic conductivity. This work demonstrated the ability to improve the ionic conduction properties of GO using relatively simple chemical methods, which opens up many new research directions. The ability to further optimize the structure of GO in solution prior to forming free standing films should lead to its use in a variety of applications. This work was published in *Angew.*

Chem. Int. Ed. (impact factor 13.734) and was selected as a Hot Article by the editors of the journal.

Impact on National Missions

This work impacts the Energy Security mission of Los Alamos National Laboratory (LANL). The ability to develop new materials to improve energy producing devices that do not require foreign oil is a national security issue. Further, this work may impact clean energy solutions to reduce green house gas emissions. In addition, LANL has a goal to be a premier materials laboratory with several large programs in the area of nanoscience, for example, the Center for Integrated Nanotechnologies (CINT) is a DOE-BES user facility that is jointly operated by LANL and Sandia National Laboratory. This work was done, in part, using the facilities available at CINT.

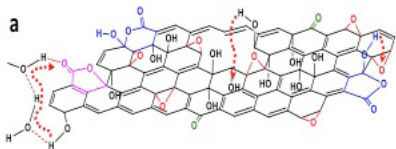

Figure 1. Schematic of the structure of graphene oxide.

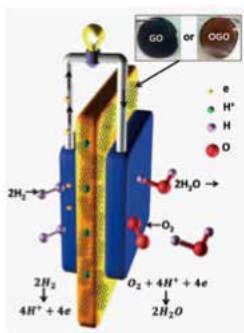

Figure 2. Schematic of a GO film incorporated into a polymer electrolyte fuel cell. Inset: photographic images of freestanding GO and ozonated GO (OGO) membranes made from the same batch of GO.

References

1. Gao, W., G. Wu, M. T. Janicke, R. Mukundan, J. K. Baldwin, E. L. Brosha, C. Galande, P. M. Ajayan, K. L. Moore, A. M. Dattelbaum, and P. Zelenay. Ozonated Graphene Oxide Film as a Proton-Exchange Membrane. 2014. *Angewandte Chemie International Edition*. 53 (14): 3588.
2. Galande, C., W. Gao, A. Mathkar, A. M. Dattelbaum, T. N. Narayanan, A. D. Mohite, and P. M. Ajayan. Science and engineering of graphene oxide. 2014. *Particles and Particle Systems Characterization*. 1 (1): 1.
3. Cao, L. J., S. B. Yang, W. Gao, Z. Liu, Y. J. Gong, L. L. Ma, G. Shi, S. D. Lei, Y. H. Zhang, S. T. Zhang, R. Vajtai, and P. M. Ajayan. Direct Laser-Patterned Micro-Supercapacitors from Paintable MoS₂ Films. 2013. *SMALL*. 9 (17): 2905.
4. Galande, C., A. D. Mohite, A. V. Naumov, W. Gao, L. J. Ci, A. Ajayan, H. Gao, A. Srivastava, R. B. Weisman, and P. M. Ajayan. Quasi-Molecular Fluorescence from Graphene Oxide. 2011. *SCIENTIFIC REPORTS*. 1: -.
5. Galande, C., W. Gao, A. Mathkar, A. M. Dattelbaum, T. N. Narayanan, A. D. Mohite, and P. M. Ajayan. Science and engineering of graphene oxide. *Particle and Particle Systems and Characterization*. 1 (1): 1.
6. Gao, W., G. Wu, M. T. Janicke, R. Mukundan, J. K. Baldwin, E. L. Brosha, C. Galande, P. M. Ajayan, K. L. Moore, A. M. Dattelbaum, and P. Zelenay. Ozonated graphene oxide film as a proton-exchange membrane. 2014. *Angewandte Chemie International Edition*. 43 (14): 3588.
7. Song, L., F. Khoerunnisa, W. Gao, W. H. Dou, T. Hayashi, K. Kaneko, M. Endo, and P. M. Ajayan. Effect of high-temperature thermal treatment on the structure and adsorption properties of reduced graphene oxide. 2013. *CARBON*. 52: 608.
8. Tian, D., D. Y. Li, F. F. Wang, N. Xiao, R. Q. Liu, N. Li, Q. Li, W. Gao, and G. Wu. A Pd-free activation method for electroless nickel deposition on copper. 2013. *SURFACE & COATINGS TECHNOLOGY*. 228: 27.
9. Tian, D., N. Li, N. Xiao, F. F. Wang, S. Y. Yu, Q. Li, W. Gao, and G. Wu. Replacement Deposition of Ni-S Films on Cu and Their Catalytic Activity for Electroless Nickel Plating. 2013. *JOURNAL OF THE ELECTROCHEMICAL SOCIETY*. 160 (3): D95.
10. Wu, G., N. H. Mack, W. Gao, S. G. Ma, R. Q. Zhong, J. T. Han, J. K. Baldwin, and P. Zelenay. Nitrogen Doped Graphene-Rich Catalysts Derived from Heteroatom Polymers for Oxygen Reduction in Nonaqueous Lithium-O₂ Battery Cathodes. 2012. *ACS NANO*. 6 (11): 9764.

Publications

Non-equilibrium Transport in Nanoscale Thermal Energy Harvesting

Jianxin Zhu

20120737PRD1

Abstract

Energy waste is a severe bottleneck in the supply of sustainable energy to keep the modern economy running. According to the U.S. Energy Use in 2013 estimated by the Lawrence Livermore National Laboratory, nearly 60% of energy is wasted. Therefore, in addition to focusing on the development of emerging renewable energy sources, it is equally beneficial to address the challenge on how to re-utilize these waste energies. This project is aimed to address the interplay between the heat, the most common form of energy waste, and the electronic and spin degrees of freedom through low-dimensional systems. It provides a theoretical underpinning for driving electronic and spintronic devices by heat. We studied the mechanism behind heat diodes, negative differential thermal conductance, and the corresponding effect associated with the spin degrees of freedom.

Background and Research Objectives

Energy harvesting and waste is a great bottleneck in the supply of energy resources to a sustainable economy. Besides developing carbon-free green energy sources, the global energy crisis can be alleviated by enhancing the efficiency of energy utilization. We are now at a new age of control energy and matter at nanoscale. Such nanoscale control creates unprecedented opportunities to directing and conversion of energy in order to achieve the greater energy sustainability. Among various forms of energy, heat, electricity and light are three conventional ones. Unlike electrons, the carriers of heat (phonons) are just quantized vibration modes that possess no mass or charge. Nowadays, a significant amount of energy is wasted in the form of heat. It will have a huge technological impact to find a way to harness the thermal energy to drive electronic and spintronic devices. Therefore a fundamental understanding of non-equilibrium transport of electrons/phonons/spins at nanoscale, the interplay between them as well as their coupling to photons, becomes critical. The goal of this project is to gain such an understanding by considering the nonequi-

librium transport through low-dimensional systems. The prototypes of these low-dimensional systems are the junctions consisting of two or multiple layers of materials or quantum dots in contact with electrical or thermal reservoirs.

Scientific Approach and Accomplishments

To achieve the above goals, we applied various theoretical tools including Keldysh Green's method, rate equations, and scattering theory. Significant progress was made in understanding the conversion and transport of energy and information.

We developed a thermal transport theory based on scattering wave approach for various interface systems, including normal metal or topological insulator and superconductor interface [1]. By applying the interfacial heat transfer formula, we uncovered several anomalous thermal properties, such as thermal energy's Klein tunneling, asymmetric Kapitza resistance and negative differential thermal resistance. We also discovered a new class of Hall-like effects. That is, the asymmetric Andreev reflection is able to induce the electric and thermal Hall-like effects in anisotropic superconductors. These findings could have potential applications for the smart energy control in various hybridized mesoscopic systems. We uncovered the fundamental effects of geometric phase and topological bands in several scenarios of energy transport [2]. Main results include: Geometric phase effect can provide additional channel for energy transfer, thus enhances the transfer efficiency; Topological bands of magnons can transfer the energy and spin information robustly and non-dissipatively; The complex bands of nonequilibrium open systems can be clarified by the braid groups and process topological phase transitions: the braid phase transition. These uncovered fundamental effects have potential applications for efficient energy transport and harvesting.

The Spin Seebeck effect is a new phenomenon that

temperature bias can produce a pure spin (without electric) current and an associated spin voltage. We have uncovered the intriguing rectification effect and negative differential conductance for spin Seebeck effect (see Figure 1) [3,4]. In this way, the spin Seebeck diode and transistor are now within our grasp. As another model system, we have recently studied the spin Seebeck effect across an insulating magnetic junction [5], in which thermal-spin conjugate transport is assisted by the exchange interactions between the localized spin in the center and electrons in metallic leads. We have shown that in contrast with bulk spin Seebeck effect; the figure of merit of such nanoscale thermal-spin conversion can be infinite, leading to the ideal Carnot efficiency in the linear response regime. We have also found that in the nonlinear spin Seebeck transport regime, the device possesses the asymmetric and negative differential spin Seebeck effects. This nanoscale thermal spin rectifier, by tuning the junction parameters, can act as a spin Seebeck diode, spin Seebeck transistor and spin Seebeck switch, which could have substantial implications for flexible thermal and information control in molecular spin caloritronics. We expect our findings will act as new methods facilitating the functional use of heat and opens a new possibility of spintronics and spin caloritronics.

Impact on National Missions

Our project has been focused on the energy harvesting and information transfer. It has addressed many fundamental questions underlying the operation of electronic and spintronic devices by harnessing the heat waste. The project is aimed to uncover the basic working principles for realizing or enhancing the Seebeck effect (thermoelectricity) and spin Seebeck effect (spin caloritronics). The project is fully aligned with the national research direction of a Secure and Sustainable Energy Future. It should have a positive impact by providing a theoretical underpinning on the thermal energy harvesting for electronic and spintronic devices. It has brought in new research direction and capability into the lab in the energy research frontier.

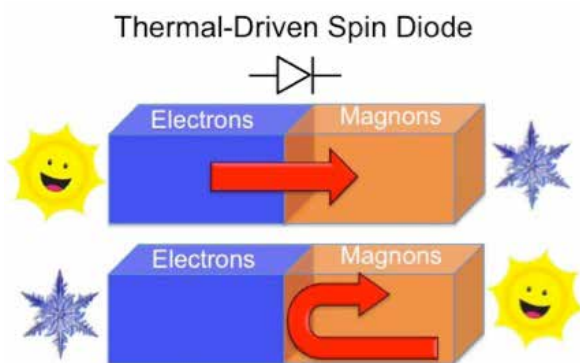

Figure 1. Sketch of a spin Seebeck diode. When the left end of the diode is at a higher temperature as compared to its right

counterpart, spin current is allowed to flow almost freely. In contrast, when the right end is made hotter than the left, the conduction of spin current becomes strongly diminished.

References

1. Ren, J., and J. Zhu. Anomalous energy transport across topological insulator superconductor junctions. 2013. *Physical Review B*. 87: 165121.
2. Zhang, L., J. Ren, J. Wang, and B. Li. Topological magnon insulator in insulating ferromagnet. 2013. *Physical Review B*. 87: 144101.
3. Ren, J.. Predicted rectification and negative differential spin Seebeck effect at magnetic interfaces. 2013. *Physical Review B*. 88: 220406(R).
4. Ren, J., and J. Zhu. Theory of asymmetric magnon tunneling under temperature bias: Rectifying spin current in a spin Seebeck diode. 2013. *Physical Review B*. 88: 094427.
5. Ren, J., J. Fransson, and J. Zhu. Nanoscale thermal spin rectifier: Controlling spin Seebeck transport across insulating magnetic junctions with localized spin. To appear in *Physical Review B*.

Publications

- Chen, T., X. Wang, and J. Ren. Dynamic control of quantum geometric heat flux in a nonequilibrium spin-boson model. 2013. *Physical Review B*. 87: 144303.
- Li, N., J. Ren, L. Wang, G. Zhang, P. Hanggi, and B. Li. Phononics: manipulating heat flow with electronic analogs and beyond. 2012. *Reviews of Modern Physics*. 84: 1045.
- Ren, J.. Predicted rectification and negative differential spin Seebeck effect at magnetic interfaces. 2013. *Physical Review B*. 88: 220406(R).
- Ren, J., J. Fransson, and J. Zhu. Nanoscale thermal spin rectifier: Controlling spin Seebeck transport across insulating magnetic junctions with localized spin. 2014. *Physical Review B*. 89: 214407.
- Ren, J., J. Zhu, J. E. Gubernatis, C. Wang, and B. Li. Thermoelectric transport with electron-phonon coupling and electron-electron interaction in molecular junctions. 2012. *Physical Review B*. 85: 155443.
- Ren, J., S. Liu, and B. Li. Geometric heat flux for classical thermal transport in interacting open systems. 2012. *Physical Review Letters*. 108: 210603.
- Ren, J., and J. Zhu. Heat diode effect and negative differential thermal conductance across nanoscale metal-dielectric interfaces. 2013. *Physical Review B*. 87:

241412(R) .

Ren, J., and J. Zhu. Anomalous energy transport across topological insulator superconductor junctions. 2013. *Physical Review B*. 87: 165121.

Ren, J., and J. Zhu. Theory of asymmetric and negative differential magnon tunneling under temperature bias: Towards a spin Seebeck diode and transistor. 2013. *Physical Review B*. 88: 094427.

Ren, J., and J. Zhu. Asymmetric Andreev reflection induced Hall-like effects in metal/anisotropic superconductor junctions. 2014. *Physical Review B*. 89: 064512.

Ren, J., and N. A. Sinitsyn. Braid group and topological phase transitions in nonequilibrium stochastic dynamics. 2013. *Physical Review E*. 87: 050101(R).

Yan, G., J. Ren, Y. Lai, C. Lai, and B. Li. Controlling complex networks: how much energy is needed?. 2012. *Physical Review Letters*. 108: 218703.

Zhang, L., J. Ren, J. S. Wang, and B. Li. Topological magnon insulator in insulating ferromagnet. 2013. *Physical Review B*. 87: 144101.

High Efficiency Upconversion of Infrared Radiation in Semiconductor-metal Nanostructures for Applications in Solar Energy

Victor I. Klimov
20120746PRD1

Abstract

The goal of this project is to explore the feasibility of increasing power conversion efficiency of solar cells using nonlinear optical effects. A specific focus is on up-conversion of infrared (IR) low-energy sub-band-gap photons into higher-energy above-gap excitations. This is a promising approach to harvesting a low-energy portion of the solar spectrum, which would otherwise “leak” through a solar cell. In principle, it can boost the power conversion efficiency of solar cells to above 50%, a considerable increase compared to a standard 31% limit. Here we investigate up-conversion via Auger recombination whereby two lower-energy excitons are converted into a single high-energy, hot exciton. In quantum dots (QDs), Auger decay is characterized by extremely short time constants (sub-100-ps) that are orders of magnitude shorter than those of radiative decay. Therefore, its efficiency is essentially unity if a multiexciton state is created in a QD. However, a number of challenges complicate application of Auger up-conversion in solar energy. A fairly low intensity of solar radiation precludes efficient generation of multiexcitons in regular QDs due to their moderate absorption cross-sections. Further, extremely fast intra-band relaxation causes up-converted hot carriers to quickly lose their energy on a picosecond timescale. In this project, we show that engineered thick-shell PbSe/CdSe QDs can help overcome these challenges. These nanostructures feature enhanced absorption cross-sections, highly efficient Auger recombination, and low rates of intraband relaxation. We use them to demonstrate efficient up-conversion of IR radiation not only with pulsed but also steady state radiation at incident intensities achievable with a moderately concentrated sun light.

Background and Research Objectives

The energy delivered by sun in one hour onto earth’s surface is sufficient to fulfill the global needs of the humanity for the entire year. Currently available solar technologies, however, have limited efficiency, which is one

of the major factors preventing their widespread use. A fundamental source of energy losses in a solar cell is its transparency towards solar radiation on the redder side of the solar spectrum, specifically for photon energies below the band gap (E_g) of the active absorbing material (Figure 1a). Methods such as stacking semiconductors with different energy gaps within a photovoltaic (PV) device (i.e., tandem cells) or the incorporation of a partially filled band within the energy gap of the absorbing material (so-called intermediate-band cells) have been explored for improved harvesting of these lower-energy solar photons. Another major source of energy loss is associated with the rapid cooling, or thermalization, of hot charge carriers generated by photons with energies well above E_g (Figure 1a). Concepts for mitigating thermalization losses involve either hot-electron extraction for increasing photovoltage (in hot-carrier devices) or use of impact ionization to increase photocurrent. In the latter process, Coulombic collisions of hot photoexcited carriers with electrons within the valence-band excite them across the energy gap, generating additional electron-hole pairs. This results in increased photocurrent that can potentially boost the power conversion limit of solar cells from ca. 30% to more than 40%.

A potentially interesting but largely unexplored approach to mitigating the transparency loss involves the use of up-conversion of sub-band-gap photons into above-band-gap excitations, which, in principle, can boost the power conversion efficiency to above 50%. The original objective of the project was to utilize the enhancement of a two-photon absorption (2PA) by plasmonic resonances in hybrid semiconductor-metal nanostructures (Figure 1b). This mechanism, however, requires extremely high instantaneous intensities, typical of short femtosecond (fs) laser pulses but not accessible in a continuous-wave regime even with strong concentration of solar radiation. Specifically, based on results of our numerical modeling we concluded that the practical enhancement of the photon-absorption coefficient due to plasmons

was of the order of 10 to 100, while applications in solar energy would require the enhancement by a factor of ca. 108. Additionally, long-term stability of the semiconductor-metal nanostructures was found to be poor especially under continuous exposure to light. Therefore, we decided to explore alternative approaches to up-conversion.

One such potentially viable approach is Auger up-conversion in engineered core/shell QDs. Specifically, appropriately designed structures can capture via this process photons with energies as low as a half band gap of the shell material if the core band-gap is also approximately half that of the shell (see Figure 1c). This up-conversion process relies on Auger recombination, whereby two lower-energy core-localized excitons are converted into a single high-energy exciton residing in the shell. By extracting the carrier directly from the shell prior to its relaxation into the core, one can in principle obtain the open circuit voltage defined by the shell band gap ($E_{g,shell}$) and at the same time boost the photocurrent due to photons from the $E_{g,shell}/2$ to E_g energy range, which would normally be discarded by the solar cell.

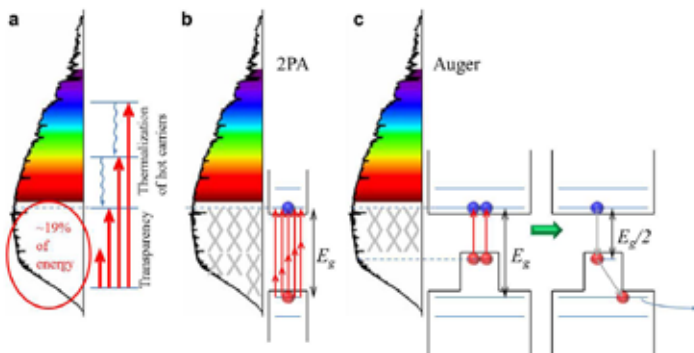

Figure 1. a) Two mechanisms for losses in a traditional solar cell. *s*: Photons with energies below the band gap of an absorbing layer “leak” through a solar cell and do not contribute to a photocurrent. *t*: Photons with energies above the band gap excite hot charge carriers that undergo rapid cooling, or thermalization, which leads to heating of the absorbing layer without contributing to either photocurrent or photovoltage. b) Non-degenerate two-photon absorption (2PA) can, in principle, be used to collect sub-band-gap photons. However, this approach suffers from the requirement of an extremely high excitation fluence, which is not achievable with solar irradiation. c) Auger up-conversion is less demanding with respect to the incident power and can be operative with moderately concentrated solar light. As in the case of 2PA, Auger up-conversion can help harvest sub-band-gap photons with energies as low as a half band gap of the shell material.

Scientific Approach and Accomplishments

To test the feasibility of Auger up-conversion we have developed a new type of core/shell QDs that comprise a small PbSe core overcoated with an especially thick CdSe

shell. We synthesize these nanostructures by a cation-exchange method. First, large monocomponent PbSe QDs are fabricated (radius R of ca. 4 nm), and then a CdSe shell of a controlled thickness (H) is prepared by exchanging Pb for Cd in the near-surface layer of the dot. This procedure maintains the total size of the structure, therefore, the increase in the thickness of the CdSe shell is accompanied by the reduction of the core size. As the H increases, the first excitonic peak in the QD absorption spectrum blue-shifts and becomes wider and weaker, up to the point ($H > 2.5$ nm) when it is no longer distinguishable (Figure 2a; black line). At the same time, the quantum yield of the core IR emission increases from $\sim 0.3\%$ for the core-only samples to $\sim 5.5\%$ for the thick-shell samples. The thin-shell QDs exhibit broad and structureless visible photoluminescence (PL), originating, most probably, from the surface defect states. As the shell thickness increases, the visible emission gets stronger and narrower. It also progressively redshifts until it reaches ~ 650 - 680 nm for the 2.8-nm-thick shell samples (Figure 2a; green line). The visible PL quantum yields increases with increasing H and is $\sim 0.1\%$ for the thickest shell samples. Performing an effective mass modeling of the structures, we assign the IR band to the 1Se-1Sh transition while the visible band to the 1Se-2Sh transition (Figure 2b). The energy of the 2Sh state is above the valence band edge of CdSe, and therefore, the corresponding hole wavefunction extends across the entire volume of the core-shell QD. This is in contrast to the 1Sh state, which is tightly confined to the core. Transition energies calculated from our model agree very well with the experimental data, especially for the large-core QDs.

We have studied nonlinear absorption properties of the QDs described above by monitoring visible up-converted emission excited with the IR fs laser pulses that are in the range of optical absorption of the PbSe core. Quadratic dependence of the visible emission intensity on excitation power confirms a two-photon excitation mechanism. The measured two-photon absorption cross-sections are about one order of magnitude larger than those of core-only CdSe QDs and reach values up to $\sim 3 \times 10^7$ GM. We explain such an increase in the cross-sections by resonance enhancement effect due to core absorption, which is further enhanced by Auger-assisted up-conversion. The latter effect is activated when two or more holes are excited in the core. In this case, the energy released during Auger recombination of one of the holes with a conduction-band electron is transferred to the other core-localized hole. In our specially designed structures, this energy is sufficient to promote a hole to the shell region where it can recombine radiatively with an electron, producing visible PL. The quantum yield of this emission is directly proportional to the time of hole re-capture by the core. To evaluate this

time we have conducted time-resolved, streak-camera studies of visible emission using 400 nm excitation with 100 fs pulses.

For the moderate fluencies (the average number of excitons per QD, $\langle N \rangle < 10$) the emission spectrum almost does not change with $\langle N \rangle$ and is similar to that of bulk CdSe. The PL dynamics is also very similar to dynamics measured for the bulk samples. As the excitation fluence increases, the spectrum gets broader, and the second peak appears at shorter wavelengths (~ 600 nm). The intensity of the original peak scales linearly with excitation fluence up to $\langle N \rangle \sim 60$, while the 600-nm peak intensity is slightly super-linear with the log-log slope of ~ 1.3 . The dynamics of the initial peak does not change with the excitation fluence, while the dynamics of the 600 nm peak is fluence-dependent. Both can be characterized by a biexponential decay with the time constants of ~ 20 -30 ps and ~ 300 ps. As the excitation fluence is increased the ratio of the amplitudes of the two components (fast-to-slow) remains constant (~ 10) for the 650-nm peak and decreases from ~ 40 to ~ 5 for the 600-nm peak. We attribute the initial fast component to hole capture by the core, while the slower component to radiative decay of shell localized holes. Based on these measurements, the hole capture time is around 20-30 ps. This time constant is significantly longer than characteristic times of intraband relaxation in standard monocomponent PbSe QDs ($\sim 0.3 - 1$ ps), which leads to a great enhancement of "hot" visible PL in our core/shell structures.

In order to prove that the efficient Auger up-conversion is realized in these core/shell QDs we studied samples that were engineered to either support or do not support Auger up-conversion based on considerations of energy conservation. In the first type of samples, the difference between the shell and the core band-gaps is greater than the core band gap, while in the second smaller. In our measurements, the intensity of visible PL was monitored as a function of pump pulse duration which varied between ~ 100 fs and ~ 10 ps (Figure 2c). PbSe QDs are known to have strong 2PA, and therefore a fairly intense up-converted emission is expected for short pulse durations (τ_{pulse}). The 2PA signal should depend linearly on the inverse of pulse duration, and therefore, is expected to decrease with increasing τ_{pulse} . Indeed, our measurements indicate this trend for pulse widths less than 300 ps (Figure 2c; red symbols). For longer pulses, however, we detect an additional contribution which is pulse-width independent. This contribution is consistent with a signal due to Auger up-conversion. Indeed, it disappears in samples that do not support this process because of energy conservation requirements (Figure 2c; blue symbols).

Another piece of evidence for efficient Auger type up-conversion is provided by our studies of visible PL as a function of pump intensity. In Figure 2d, we show the results of these measurements for both pulsed and continuous-wave (cw) excitation regimes. The 2PA mechanism is expected to be operative only in the pulsed mode. On the other hand, Auger up-conversion should be active under both excitation regimes. Indeed, the measurements demonstrate that our core/shell structures show strong up-converted PL signals of similar intensities for both pulsed and steady state excitations. These results exclude the 2PA mechanism and directly point towards the process of Auger up-conversion.

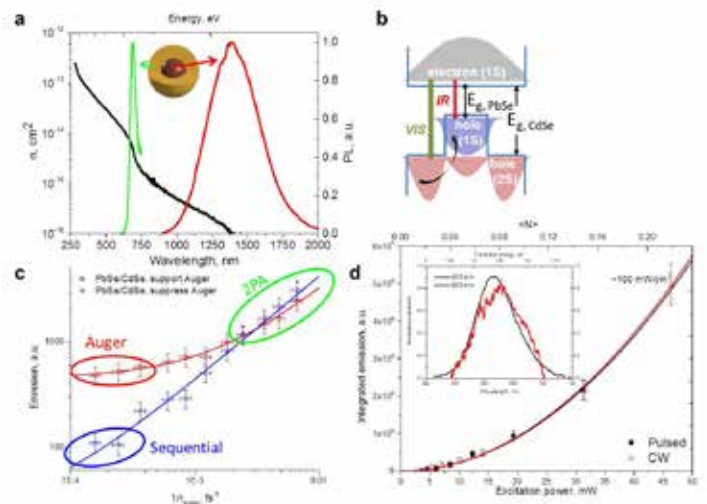

Figure 2. a) Engineered thick-shell PbSe/CdSe QDs ($r = 2.2$ nm, $r_c = 1.8$ nm) exhibit strong absorption (black line) and dual-band emission in the IR (red line) and the visible (green line). b) The IR band originates from radiative recombination of a delocalized electron with a core-localized hole (red arrow), while visible emission involves a shell-localized hole (green arrow). c) The up-converted emission intensity as a function of inverse of pulse duration for QD samples that either support (red symbols) or do not support (blue symbols) Auger up-conversion based on energy conservation. d) Experimental demonstration of Auger up-conversion using the regimes of pulsed (black symbols) or continuous-wave (cw) (red symbols) excitation. Inset: the emission spectra recorded using either above- (black line) or below- (red line) band-gap excitation.

Impact on National Missions

The conducted studies represent the first experimental demonstration of a new approach to converting sub-band-gap IR radiation into higher energy excitations via Auger up-conversion in engineered QDs. This approach can serve as a potential enabler of third-generation PVs with the efficiency exceeding that of a traditional Shockley-Queisser limit. Due to its large promise, the topic of Auger up-conversion was recently included as one of the research directions in the program of the Center for Advanced Solar Photophysics recently re-renewed by the Office of Science

of DOE. In addition to their potential for PV applications, novel core-shell PbSe/CdSe QDs explored in the present project exhibit a number of other unusual and useful properties such as dual-color emission comprising two widely separated bands in the IR and the visible. This property can be utilized for realizing dual-color probes in two-photon bioimaging or ratiometric sensing of chemical environment. All of these potential applications are of direct relevance to LANL and DOE missions in a range of areas from clean energy and energy efficiency to homeland security.

Publications

- Cirloganu, C. M., L. A. Padilha, Q. Lin, N. S. Makarov, K. A. Velizhanin, H. Luo, I. Robel, J. M. Pietryga, and V. I. Klimov. Enhanced carrier multiplication in engineered quasi-type-II quantum dots. 2014. *Nature Comm.* . 5: 4148.
- Makarov, N. S., H. McDaniel, N. Fuke, I. Robel, and V. I. Klimov. Photocharging artifacts in measurements of electron transfer in quantum-dot-sensitized mesoporous titania films. 2013. *J. Phys. Chem. Lett.* . 5 (1): 111.
- Makarov, N. S., Q. Lin, K. Velizhanin, and V. I. Klimov. PbSe/CdSe core/shell colloidal quantum dots with enhanced optical nonlinearities and dual-band infrared/visible emission. 013. In *Conference on Nonlinear Optics*. (Kohala Cost, HI, USA, July 21-26, 2013). , p. NTh1A.3. Washington: Optical Society of America.

Minority Carrier Devices Based on Concentric Nanowires: Theory and Experiment

Quanxi Jia

20120747PRD1

Abstract

A wide range of activities have been carried out to investigate the carrier dynamics and device physics of Ge/Si nanowire (NW) structures, and explore the potential of NW devices in a number of application fields. In the area of solar cells and energy harvesting, we have utilized a finite-difference time domain simulation framework to simulate the absorption process and carrier dynamics in radial p-n junction NW array for solar cells. Simulation results have provided a complete perspective on the dependence of performance on device geometry, and suggested optimal designs for experimental realization. In the area of nano-electronics, advanced control over material synthesis and nano-fabrication enabled the realization of high performance Ge/Si core/shell NW field effect transistors (NWFETs) and a thorough assessment of their electronic properties. We have experimentally demonstrated a tremendous advantage of Ge/Si core/shell NWs over many nanoscale structures which commonly suffer from performance degradation due to severe surface effects when the bulk volume to surface ratio decreases with size. With the epitaxial Si shell confining holes in the narrower bandgap Ge core, the carriers are protected from detrimental surface scattering processes, thus, having an enhanced mobility which is independent on NW diameters. The advantages of core/shell NW structure were further exploited with a novel transistor design based on a cylindrical Ge quantum well confined in concentric silicon barriers. NWFET performance optimization was pursued by miniaturizing channel length for faster speed and lower energy consumption. Using in situ TEM, we have successfully controlled the solid-state reaction of Ni with Ge/Si NWs, achieving a 2 nm short semiconductor NW channel sandwiched between the metallic NiGe/NiSi electrodes. In addition, the broadening of NW growth and fabrication capability has allowed for the realization of novel NW devices in thermoelectrics and lithium ion batteries.

Background and Research Objectives

In recent years, NW research has achieved excellent progress in both understanding and controlling of the growth dynamics and materials' quality. These provide a solid foundation for the development of NWs in traditional electronic, opto-electronic devices, as well as emerging devices for energy applications such as solar cells, lithium ion batteries, and thermoelectric devices. At nanoscale where the surface area becomes significant over bulk volume, such devices could be severely affected by the surface or material imperfection, which can alter the carrier dynamics and physics of the device operation. Revealing and optimizing carrier dynamics in nanoscale devices remains a fundamental and technological challenge that hampers their applications despite their great promise for higher speed, lower power consumption, and higher efficiency, etc.

The goal of this work is to achieve a comprehensive understanding on carrier dynamics at nanoscale and to identify novel physics intrinsically related to small dimensions in order to provide insights for nano-device design and optimization. This work provides a robust assessment of the fundamental limits of NW devices as well as enables the realization of novel device configurations for novel applications.

Scientific Approach and Accomplishments

This work entailed a large variety of tools and skills which enabled comprehensive studies of different aspects of NW structures and devices. Theoretical modeling tools such as FDTD Solutions of Lumerical Inc. and Atlas simulator of Silvaco Inc. were utilized to simulate the light absorption/propagation process, electronic band profiles, and carrier dynamics in NW devices. NW materials were grown using a low pressure chemical vapor deposition (CVD) system, and were characterized by scanning electron microscopy (SEM) and transmission electron microscopy (TEM). Extensive research on growth condition optimization has resulted in new

configurations of NW heterostructures in axial and radial directions. NWs qualified in structural characterization with SEM and TEM were then fabricated into devices for various application purposes. This fabrication process involved a large combination of tools and systems at CINT such as HRTEM and in-situ thermal annealing under TEM, e-beam/photo lithography, Scanning electron microscopy/ Focused Ion Beam (SEM/FIB), metal deposition by e-beam evaporation and sputtering, plasma-enhanced chemical vapor deposition (PECVD) and atomic layer deposition (ALD) of high-k dielectrics, inductively coupled plasma (ICP) dry etchings of Si, Ge and dielectrics, and thermal oxidation furnaces. The combination of high quality materials and advanced fabrication techniques has resulted in accomplishments of several studies, some of which are highlighted below:

Arrayed NW solar cells: Absorption process and device physics

The radial p-n junction Si NW array has been considered an attractive candidate for cost-effective solar cells. The highlight of the design is the combination of the array collection of NW for enhanced light trapping and absorption and the radial p-n junction geometry that allows efficient collection of photo generated carriers. We have investigated the light-matter interaction in Si NW arrays using finite difference time domain (FDTD) framework. The absorption process as a function of array geometry (pitch size, material occupation factor) and NW dimension (length, diameter) was systematically studied and showed good agreement with experiments. We have succeeded in simulating a special effect due to a unique geometry that was observed experimentally. Due to the facet selective growth, the deposition of a thin Si shell on the sidewall of etched Si pillar resulted in a spherical structure on the top of the NW. The structure, the so-called match head, acts as a micro-lens that converges light into the center of the wire. FDTD simulation indeed shows stronger absorption in the case of match head, which justifies the high quantum efficiency achieved experimentally on NW array with match head.

NW field effect transistors: systematic performance assessment

NWs are an attractive candidate for new generation field effect transistors due to their unique configuration that allows effective electrostatic coupling between gate control voltage and the carrier conduction channel. High performance Si/Ge NW FETs have been demonstrated, but so far, little work has been reported on the device physics and experimental proof for the advantages of the Ge/Si core/shell structure over standard Si or Ge NWs. A large number of Ge/Si core/shell NWs with different diameters were processed into FETs and characterized to extract the size-de-

pendence of FET performance (Figure 1). Our study is the first to experimentally reveal the diameter-independent hole mobility of the Ge/Si core/shell NW structure. While other nano-systems suffer from degraded mobility with reduced size, the experimental constant mobility in the Ge/Si core/shell NW system is a strong affirmation for the advantages of the core/shell NWs over other nanosystems. Comparison between Ge/Si core/shell and Ge NWs exhibited a factor of 5-fold increase on-current, which is shown to be due to mobility enhancement in core/shell NWs. The comprehensive analysis of transistor performance in the diameter dependent context allows us to associate the enhanced transistor figures of merits with the processes due to the presence of the Si shell: 1) carrier accumulation and 2) mobility enhancement, which have been proposed in previous studies but are clearly validated and firmly distinguished here.

Gate All Around Ge/Si Core/Shell NW FETs: Improved electrostatic coupling

In order to improve the device performance with better electrostatic coupling between the gate voltage and the conducting channel, we have developed a process for a gate all around NWFET. We developed a process for the conformal atomic layer deposition in a short pulse duration and a small number of pulses using trimethyl(methylcyclopentadienyl) Platinum(IV) precursor. This is accomplished by cycling tri-methyl aluminum for an optimal number of cycles to facilitate nucleation of Pt on pre-deposited HfO₂ dielectric. Figure 2 shows the resultant gate all around the Ge/Si/HfO₂/Pt core/multi-shell NW with Ni₂Ge/Ni₆Si₆ source/drain regions extending underneath the Pt gate. The transfer curves with VSD = 100 mV are shown in Figure 3. Reliability of these devices remains an issue, likely due to the aqua-regia etch used to open the source/drain regions in Pt in order to provide access to the Ge/Si core/shell NW.

Quantum well in a wire FET: a novel device structure for improved performance

As shown in the previous study in the section above, the optimization of NWFETs is limited as all performance merits are controlled by a single knob: the NW's diameter (Figure 3b). Large NWs have more charge accumulated near the NW's circumference, thus having higher on-current but also suffering from worse off-regime characteristics due to the larger volume to be depleted. This is in contrast to ultra-thin body planar FETs (Figure 3c) where the on-current is dictated by the device width (W), and the off-characteristics are governed only by the device depth (t). A solution for this disadvantage is the cylindrical quantum well in a nanowire (CWIN) design consisting of a Si/Ge/Si core/multi-shell with a Ge conduction channel and a thin Si outer shell for surface protection (Figure 3a). In this design,

the on-current is controlled by the perimeter of the Ge shell, while the off-current is only affected by the thickness of the Ge layer, because the inner Si core is already depleted, requiring no extra effort to turn off the transistor. The challenge for this design resides in the materials growth, as an island-like growth mode rather than conformal coverage was reported for the deposition of Ge on Si NWs due to the large lattice mismatch (4%). We have developed the growth conditions for conformal deposition of Ge shell on the Si core. Extensive structural analysis under TEM reveals that the Ge is initiated with island mode on {113} facets of the [112] Si NWs (Figure 4a), then the islands coalesced with longer deposition time to form a uniform conformal shell (Figure 4b). This study provided the first in-depth investigation on the evolution of the nucleation and deposition of Ge on Si NWs, especially, with strong evidence on facet-selective nucleation.

Aiming to create ultra-short (<10 nm) channel length FETs for higher speed and lower power consumption, solid-state-reaction between Ni and Ge/Si core/shell NWs is utilized to create a NiGe (or Si)/Ge(Si)/NiGe(Si) metal/semiconductor/metal with controlled size. Thermal annealing provides kinetic energy to Ni atoms to penetrate into Ge/Si semiconductors and create metallic NiGe/NiSi layers with high electrical conductivity, which can serve as drain and source for the un-reacted Ge/Si semiconductor channel in FETs. Developments in device fabrication allow us to integrate FET device structures on a 50 nm thick Si₃N₄ membrane in order to monitor and control reaction mechanism in-situ with HRTEM. Reaction between Ni with Ge/Si heterostructure exhibited completely different reaction behaviors/mechanisms that have not been observed in Ni-Ge or Ni-Si reactions. Despite NiGe having a lower nucleation energy barrier than NiSi₆, we observe that the NiSi₆ nucleates first and leads the reaction along the axis of the NW compared to Ni₂Ge (Figure 5a). Without appropriate management of this problem, it establishes a limit over which ultra-short channel devices in Ge/Si core/shell NWs could be realized. By removing the Si shell locally under the Ni contact to promote Ni₂Ge formation, simultaneous propagation of the Ni₂Ge and the NiSi₆ was accomplished as demonstrated in Figure 5b. Abrupt Ni₂Ge/NiSi₆-Ge/Si-Ni₂Ge/NiSi₆ metal-semiconductor-metal heterostructured NWs are achieved here with ~ 14 nm unreacted Ge/Si core/shell gap, and the technique has been successfully utilized to demonstrate 2 nm Ge/Si gap in the heterostructured NW.

Thermoelectrics of superlattice-nanowire

High-efficiency thermoelectric (TE) materials are important for power-generation and solid-state refrigeration. The ultimate figure of merit for a thermoelectric material is the ZT

number, which is the product of the absolute temperature T , the power factor ($S^2\sigma$, where S is the Seebeck coefficient and σ is the electrical conductivity) and the inverse thermal conductivity (κ). Superlattice designs have been shown to significantly improve the thermal power factor as well as to reduce the thermal conductivity for an overall optimization of ZT. Recently, NWs were added to the potential candidate list thanks to the reduction of thermal conductivity, attributed to the enhanced phonon scattering at the NW surfaces. Marrying the two architectures to form a superlattice NW with combined advantages has been theoretically addressed and is of great interest for experimental realization. We have pursued two approaches to realize such superlattice structure with the Ge, Si NW system. In the first approach, we utilized the CVD system to grow NWs with alternating sequence of Ge and Si, and achieved the first 100% compositional modulation Ge/Si superlattice NWs grown by VLS mechanisms. Another approach is to create the semiconductor/metal superlattice from bottom up NWs. Multiple Ni pads were deposited across a NW, then the solid-state reaction was controlled via thermal annealing, forming a superlattice structure consisting of alternating semiconductor/nickelide segments. The novelty of this structure is the large compositional and crystalline mismatch at the metal/semiconductor interfaces. Moreover, the Schottky barrier at the metal/semiconductor interface offers a way to decouple the electrical and thermal conductivities, as the electrical conductivity can be modulated relatively independently by adjusting the doping concentration, thus altering the effective barrier height for electrical transport. Our superlattice NW devices have been successfully fabricated, and are now being measured by our collaborators at CINT, Sandia and NMSU.

Impact on National Missions

This work lies at the heart of solar cell technology and low power transistor devices, both of which tie well with the DOE and DOD energy agenda. New understanding on carrier dynamics, device physics of Ge/Si core/shell NW systems provides a robust assessment of the fundamental limits and potential of NW devices, and may inspire new research directions in the area of photovoltaics. The universal physics can also be applied to understand and better utilize other materials systems. Novel NW geometries and device configurations developed in this work have exhibited great potential for low power, high speed electronic, opto-electronic and energy harvesting devices.

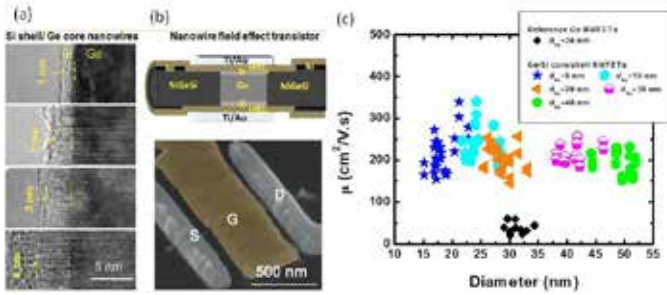

Figure 1. (a) High resolution transmission electron microscopy (HRTEM) images of Ge/Si core/shell NWs illustrate precise control of Si shell thickness from 1 to 4 nm with step of 1 nm, (b) Schematic diagram and Scanning Electron microscopy (SEM) image of the NWFET device structure and (c) Extracted hole mobility from ~100 devices shows a constant mobility for Ge/Si core/shell NW-FETs over a total diameter range from 15 to 50 nm. Compared to reference Ge NW-FETs, Ge/Si core/shell devices possess ~5 times larger mobility.

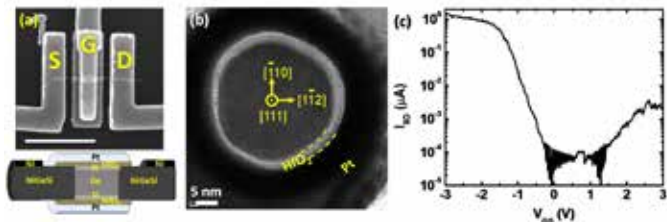

Figure 2. (a) SEM image of a gate all around Ge/Si core/shell nanowire FET with NiGe/NiSi source/drain regions, and cross-section schematic along the length of the nanowire device. (b) Cross-sectional TEM image across the Pt gate region. (c) Transfer curve of a gate all around device at $V = 100$ mV.

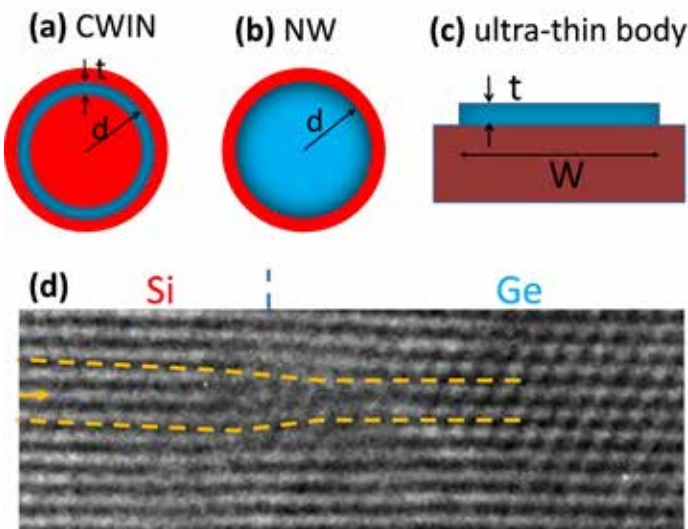

Figure 3. CWIN design (a) with two degrees of freedom possessing the advantages of 1D NW design (b) and ultra-thin body (c). High resolution TEM (d) shows perfect misfit dislocation at the Si/Ge core/shell interface enabling thick Ge shell deposition.

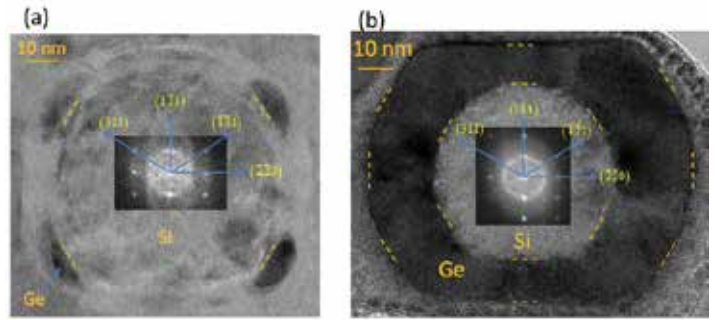

Figure 4. Cross-sectional TEM of Ge/Si core/shell NWs: (a) short growth time with Ge island nucleated in {113} facets, and (b) long growth time with conformal coverage of the Ge shell around the Si core.

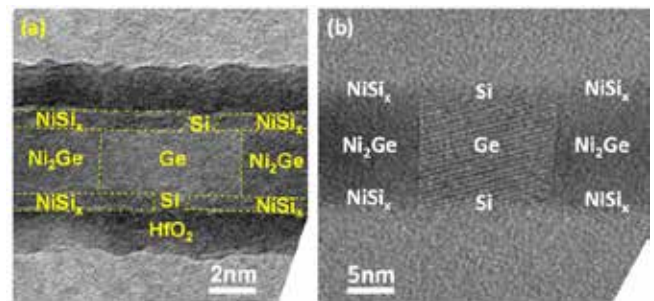

Figure 5. (a) Leading NiSi interface in conventional and (b) simultaneous NiGe/NiSi interface propagation in our approach.

Publications

Dai, X., B. M. Nguyen, Y. Hwang, C. Soci, and S. A. Dayeh. InGaAs FinFETs on Silicon in a Fab-Compatible Process. To appear in Adv. Functional Mater..

Dayeh, S. A., W. Tang, B. M. Nguyen, X. Dai, Y. Liu, Y. Hwang, X. H. Liu, and R. Chen. Nanoscale Heterogeneous Reactions and Interfaces in Ge/Si and for III-V on Si Integrated Devices. Invited presentation at ECS Meeting. (San Francisco, CA, 27 Oct - 1 Nov. 2013).

Hwang, H., B. M. Nguyen, and S. Dayeh. Atomic Layer Deposition of Platinum with Enhanced Nucleation and Coalescence by Trimethylaluminum Pre-Pulsing. 2013. Appl. Phys. Lett.. 103: 263115.

Liu, Y., X. H. Liu, B. M. Nguyen, J. Yoo, J. P. Sullivan, S. T. Picraux, J. Y. Huang, and S. A. Dayeh. Tailoring Lithiation Behavior by Interface and Bandgap Engineering at the Nanoscale. 2013. Nano Letters. 13: 4876.

Nguyen, B. M., J. Yoo, S. A. Dayeh, P. Schuele, D. Evans, and S. T. Picraux. Design of Radial p-i-n Silicon Nanowires for High-Performance Solar Cells. 2013. In The Wonder of Nanotechnology: Quantum Optoelectronic Devices and Applications. Edited by Razegh, M., I. L. Esaki, and K. von Klitzing. , p. 823. Bellingham, WA: SPIE Press.

Nguyen, B. M., J. Yoo, S. A. Dayeh, P. Schuele, D. Evans, and

-
- S. T. Picraux. Design of Radial p-i-n Silicon Nanowires for High-Performance Solar Cells. 2013. In *The Wonder of Nanotechnology: Quantum Optoelectronic Devices and Applications*. Edited by Razeghi, M., L. Esaki, and K. von Klitzing. , p. 823. Bellingham, WA: SPIE Press.
- Nguyen, B. M., J. Yoo, S. A. Dayeh, and S. T. Picraux. Design of radial p-i-n Si nanowires for high performance solar cells. Presented at 11th international conference on infrared Optoelectronics: Materials and Devices (MIOMD XI). (Evanston, IL, Sep. 2012).
- Nguyen, B. M., W. Tang, S. T. Picraux, and S. A. Dayeh. One dimensional transport in Ge/Si core/shell nanowires: physics and devices applications. Presented at CINT User Conference. (Albuquerque, 19-20 Sept.).
- Nguyen, B. M., W. Tang, and S. A. Dayeh. Ultra-short channel field effect transistors based on Ge/Si core/shell nanowires. Invited presentation at SPIE Photonics West. (San Francisco, 2-7 Feb. 2013).
- Nguyen, B. M., W. Tang, and S. A. Dayeh. Ultra-short channel field effect transistors based on Ge/Si core/shell nanowires. Invited presentation at SPIE Photonic West. (San Francisco, CA, Feb. 2013).
- Nguyen, B. M., Y. Liu, W. Tang, S. T. Picraux, and S. Dayeh. Ultra-short channel field effect transistors based on Ge/Si core/shell nanowires. Invited presentation at SPIE Photonic West. (San Francisco, CA, Feb. 2013).
- Nguyen, B. M., Y. Liu, W. Tang, and S. Dayeh. Tailoring Ni-Ge/Si core/shell reaction rates through in-situ microscopy for ultra-short channel nanowire field effect transistors. Presented at MRS Spring Meeting . (San Francisco, CA, April 2013).
- Nguyen, B. M., Y. Taur, S. T. Picraux, and S. A. Dayeh. Diameter-independent hole mobility in Ge/Si core/shell nanowire field effect transistors. 2014. *Nano Lett.* 14: 585.
- Nguyen, B. M., and S. A. Dayeh. Single Crystalline Si/Ge/Si Core-Multiple Shell Nanowires for Advanced Cylindrical Well Field Effect Transistors. Presented at MRS Fall Meeting. (Boston, MA, Dec. 2013).
- Ribaudo, T., A. Taylor, B. M. Nguyen, D. Bethke, and E. A. Shaner. High efficiency reflective wave plates in the midwave infrared. 2014. *Optics Express*. 22: 2821.
- Tang, W., B. M. Nguyen, R. Chen, and S. A. Dayeh. Solid State Reaction of Nickel Silicide, Germanide and Alloyed III-V Contacts to Semiconductor Nano-Channels. To appear in *Semiconductor Science and Technology*.

Functional Soft Materials by Assembling Metallo-Biopolymers

Reginaldo C. Rocha
20120765PRD3

Abstract

The organization of dissimilar classes of nano-, micro-, and mesoscale materials into well-defined macroscale structures with complex and tunable functional behavior represents the next frontier of materials science and engineering. Nature serves the purpose of inspiration by providing a catalog of smart materials featuring emergence of stimuli-responsiveness and multifunctionalities. This project explores a novel approach to the construction of metal-containing biopolymers via supramolecular assembly. The site-specific incorporation of metal-ligand centers into biopolymers not only introduces rich opto-electronic, redox, magnetic, and chemical functionalities but also plays an important role in directing higher-order structural hierarchy. Our overarching objective is to develop new biomaterials technologies by using coordination chemistry to instruct protein-protein docking interactions. The proposed R&D approach was applied toward 1) the guided assembly of polypeptide structures and lattices, and 2) the control of biological reactions and signaling pathways. In cellular processes, protein-protein assembly interactions are directed by the superposition of many weak forces spread over large surfaces, making the design and control of synthetic higher-order structures a tremendous challenge. On the other hand, metal-ligand coordination can be highly directional, specific, and mostly under thermodynamic and kinetic control. We used a combination of site-specific incorporation of metal ions, post-translational conjugation, and unnatural amino-acid modifications to create stable metal-coordination sites on protein surfaces to provide crosslinking units for metal-mediated assembly of supramolecular structures. Applications of resulting materials include the use of such metal-linked protein arrays as templates for nanofabrication in the areas of biosensing, photovoltaics, and electronic/photonics devices. Additionally, the sacrificial and reversible nature of the metal-ligand bonds in these metallo-biopolymers can find practical applications in self-healing, regenerative, and autonomous (nano)materials.

Background and Research Objectives

The extensive use of polygalacturonic acids and alginates in textiles, food, and biomedical industries is based on the high electrostatic charges of the polysaccharide structures and their ability to form multilayer gel-like structures in the presence of metal cations. Evidently, ideal information-rich materials should be able to translate positional and orientational orders beyond the single-molecule level to the next hierarchical level. This project introduces a designed motif of higher-level biopolymer structures where helical polypeptide chains strongly associate by specific sequestration and binding of metal ions. Not only do metal centers bring their rich optical, electronic, and redox capabilities to such biopolymers but also they can play the role of dynamic cross-linkers by assembling multiple polymer strands together. Similarly, secondary structures can be conceived of in the context of the so-called “egg-box model” by replacing intra-strand hydrogen bonds with site-specific placement of metal-based cross-linkers. Metal-ligand interactions can capture all the salient features of protein-protein interactions (specificity, directionality, symmetry, and reversibility) on a much smaller surface than needed by non-covalent interactions. The reversibility of metal-ligand coordination also allows for the self-correction necessary to produce assemblies with long-range order. Importantly, chemical control and tunability are inherent in this approach, as metal-directed self-assembly is dependent on external stimuli and can be dictated by the choice of metal ions and binding motif. The potentiality of resulting novel materials is determined by the tunability of specific functionalities and stimuli-responsiveness, as well as the dynamic nature of the supramolecular metallo-biopolymers.

Scientific Approach and Accomplishments

A central goal of our work was to construct a library of metal-biopolymer complexes by combining the rich information content of biopolymers with the tunable redox, optical, magnetic, and catalytic properties of metal-

ligand units. Metals can be introduced into biopolymers in three different ways: tethering to the polymer backbone as a preformed metal-ligand complex (class I), coordination with a ligand-biopolymer conjugate via a “plug and play” approach (class II), or direct coordination with groups intrinsic to the biopolymer (class III). As summarized below, we have pursued and successfully demonstrated each of these strategies through synthesis and characterization of metallo-biopolymer assemblies based on elastin-like polypeptides (ELPs). As a class of biopolymers based on the amino acid sequence of elastin, ELPs are composed of repeats of the pentapeptide motif Val-Pro-Gly-X-Gly (where X can be any amino acid other than proline). These genetically engineered polymers can be designed at the DNA level to precisely control their structure and properties. A hallmark feature of this type of biopolymers is their phase transition, a property that can be genetically manipulated by design. ELPs exhibit aggregation and conformational changes that are sensitive to environmental conditions and, in aqueous media, can undergo a reversible phase transition within a narrow temperature range. For the ELPs used in this work, the composition of the polymer construct and sample conditions have been such that the critical transition temperature (T_t) lies around 25 °C.

Based on a comprehensive literature survey on bioconjugation chemistry, we have implemented different methods to take advantage of our new ligand units functionalized with -NH₂/-COOH groups (R) complementary to the biopolymer side-chain functionalities suitable for carbodiimide coupling chemistry. In both classes I and II, the successful introduction of metal-ligand components into specific biopolymer sites has been confirmed by nuclear magnetic resonance (NMR), gel electrophoresis, and time-dependent monitoring of the bioconjugation reactions using mass spectrometries (electrospray ionization and matrix-assisted laser desorption/ionization).

In class I, we have systematically modified substituent groups on complexes of transition metals with polypyridyl ligands to modulate their electronic properties and strong metal-to-ligand charge-transfer (MLCT) absorptions across the visible spectral region. We have developed a suite of transition-metal complexes in which one fixed bidentate ligand having conjugation sites partnered with various other ligands (LL) to achieve improved photophysical and redox properties that can be tunable by medium conditions, such as pH or solvent. After successful conjugation with polypeptides, we confirmed that MLCT absorptions are retained in the formed conjugated assemblies (Figure 1A). Electrochemistry by differential pulse voltammetry (DPV) revealed that the redox potential of the metal-ligand component is perturbed significantly upon conjugation (Figure

1B). However, the most striking result was a 3-fold increase in the metal complex-based photoluminescence intensity (Figure 1C) upon the biopolymer coacervation above the transition temperature (Figure 1D). This unique, interesting behavior is in sharp contrast with the typical temperature-dependence of luminescence in homogeneous solutions. Upon carrying out extensive structure-property studies, we have surmised that this coacervation-induced effect is due to an increased rigidity and structural restriction imposed on the metal-ligand component by the microenvironment of the coacervated biopolymer.

In class II, we have adopted a “plug and play” approach where the side-chain length of R groups of a terpyridine unit has been varied systematically to procure a spectrum of reactive ligands with variable exposure to metal coordination. The ligand-functionalized side chains were capable of readily binding to a series of lanthanide ions, giving luminescent biopolymer solutions and thin films with Eu³⁺ (red), Tb³⁺ (green), or Dy³⁺ (blue) (Figure 2). The photoluminescence spectra of these assemblies cover the entire visible range, raising the possibility of generating different colors and the combination of these into others, including white light. From the synthesis of easily accessible and versatile building blocks, we have also fabricated near-infrared (NIR) hybrid materials containing covalently bonded complexes of tris(dibenzoylmethanate)Ln (Ln = Er, Nd) in terpyridine-functionalized ELPs. The spectroscopically characterized hybrids exhibit the NIR luminescence of Er³⁺ and Nd³⁺ ions by intramolecular energy transfer from the triplet state of ligands to the resonant emissive state of the central lanthanides.

Another exciting accomplishment was the development of a method for constructing hybrid organic-inorganic nanocomposites (class III) from recombinantly expressed ELPs as the bio-organic component and calcium or copper ions as the inorganic component (Figure 3). By taking advantage of the recently created libraries of ELP derivatives, our team has shown not only the formation of flower-like nanocomposites with metal ions but also that the morphology of these hierarchical structures with high surface-to-volume ratios has proven to be dependent upon the temperature of growth, as characterized by scanning electron microscopy (SEM) and other techniques. Whereas nanoflowers grown from the highly soluble ELPs at 4 °C (below T_t) displayed larger petals with a more expanded morphology, those formed from aggregates at 37 °C (above T_t) featured nanosized petals in a more closed morphology as a result of coacervation and thus higher density of nucleation centers for growth of metal-phosphate nanocrystals. X-ray diffraction (XRD) studies further confirmed the chemical composition of crystals to be monetite

(CaPO₃(OH)), a more attractive form of calcium phosphate that can be more readily resorbed in clinical applications of biomaterials that require rapid integration of implants or grafts. Therefore, beyond the simple creation of beautiful structural nanopatterns, biopolymers can emerge as useful platforms toward the highly desirable control of morphological features in the development of functional near-natural materials for applications such as tissue engineering and (bio)catalysis.

We have then studied the behavior of metallo-biopolymer assemblies in two classes of materials: hydrogels and thin films. Hydrogels are water-swollen polymer networks that have found applications ranging from biological scaffolds to super-adsorbent materials. Hydrogels have also garnered attention because they display unique mechanical properties and are capable of mimicking extracellular matrix environments (ECMs). ELP-based hydrogels are especially interesting due to their dynamic nature, with distinct morphologies as a response to temperature. For instance, ELP hydrogels have shown different pore sizes upon swelling of water at temperatures below and above the phase transition T_t of the ELP (Figure 4A and 4B). We have exploited this change in the microenvironments of ELP hydrogels by incorporating optically and redox active units via bioconjugation or simple doping. We next showed that the distinct thin-film morphologies of ELPs (Figure 4C and 4D) can be enriched with novel optical and electrochemical properties brought about by the synthetic active components. We expect that the methods established by this work for preparation of optically and electronically active, biodegradable and sustainable polymer matrices will lead to further development of a broad new class of advanced (bio)materials with emerging properties.

Impact on National Missions

This research supports our national missions by providing advancements toward the development and fundamental understanding of novel materials for energy and environment sciences and technologies. With the development of biopolymer-based functional (nano)materials and their target applications in the areas of renewable energy, biosensing, regenerative medicine, optical and electronic devices, and self-healing systems, this research is highly relevant to the DOE (SC/BES), DOD (DARPA), and DHHS (NIH), in addition to possible deployment and utility to NASA and Intelligence missions. DHS and DTRA also have a vital interest in biodegradable polymers and wound-healing biocompatible materials, which represent an underlying theme in this work. Therefore, through the creation of capabilities and involvement in this new field, our project can lead to funding opportunities from several government agencies. This research also ties directly into LANL's missions through

the “Materials for the Future” Science Pillar, in addition to its alignment with our DOE's Center for Integrated Nanotechnologies (CINT) missions in nanoscience and nanotechnology.

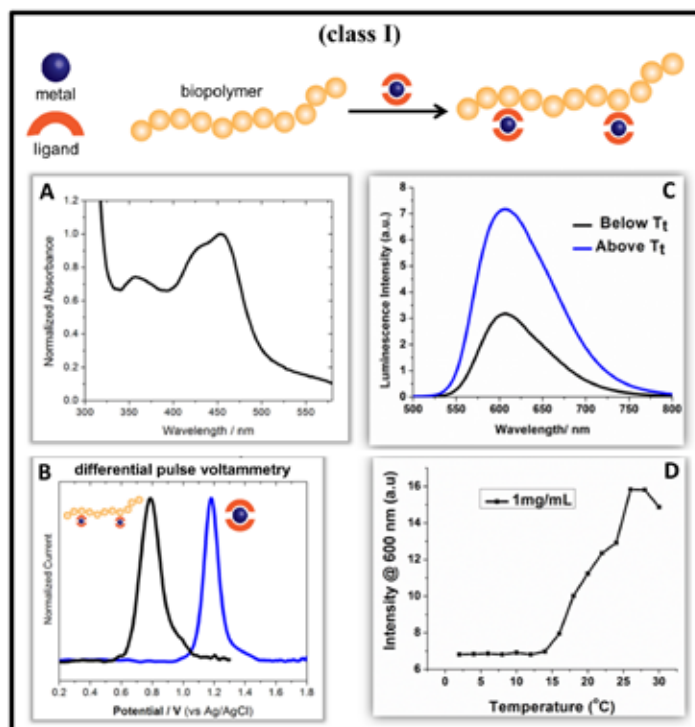

Figure 1. Metallo-biopolymers from conjugation of metal-ligand complexes (class I) and emergent properties of integrated assemblies.

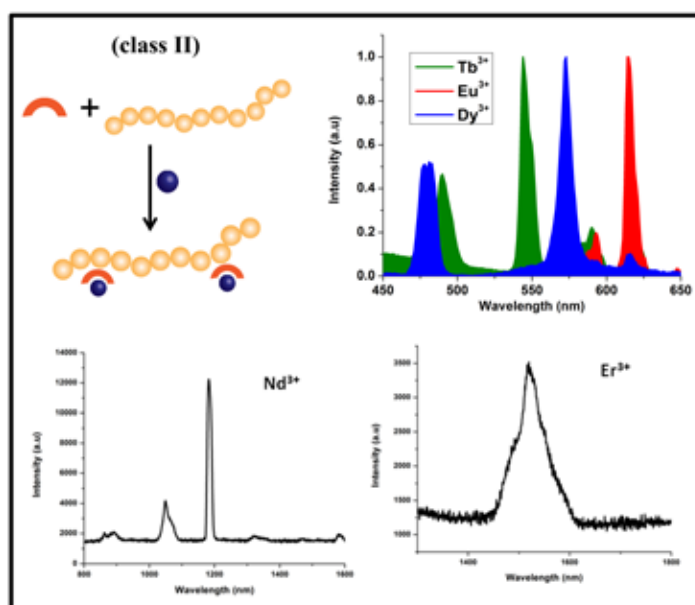

Figure 2. Metallo-biopolymer conjugates from a plug-and-play strategy (class II) and resulting photoluminescence covering the visible and near infrared spectral regions.

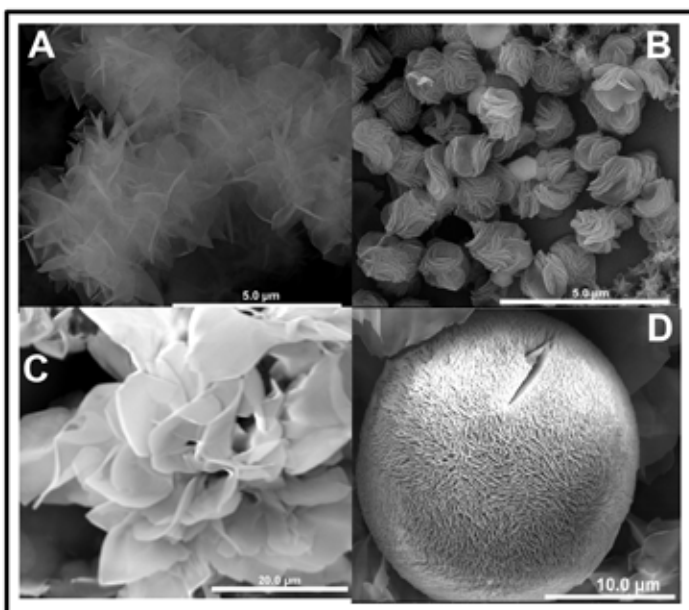

Figure 3. Metallo-biopolymer composites (class III): SEM images of flower-shaped nanostructures grown from the mixtures of an ELP, CaCl₂, and PBS incubated at 4 °C (A) and 37 °C (B), and from the mixture of an ELP, CuSO₄, and PBS incubated at 4 °C (C) and 37 °C (D).

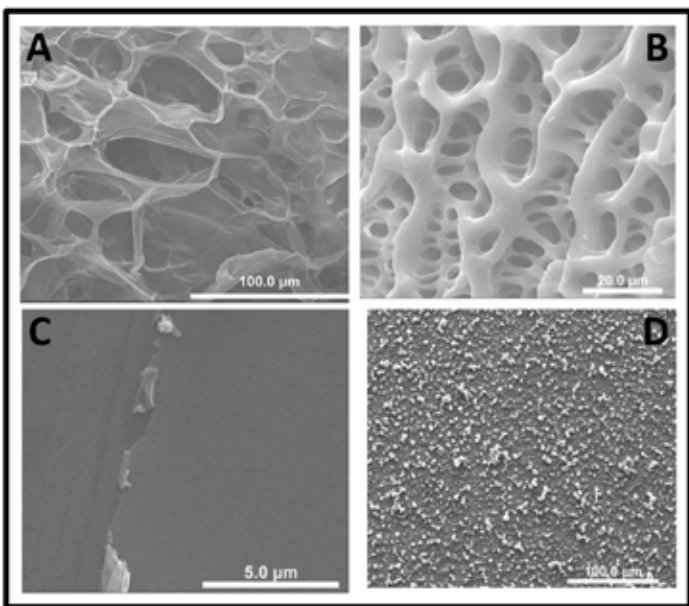

Figure 4. Morphological differences of ELP hydrogels and thin films: SEM images of swollen hydrogels incubated at 4 °C (A) and 37 °C (B), and thin films incubated at 4 °C (C) and 37 °C (D).

Publications

Balog, E. R., K. Ghosh, Y. Park, H. Wang, R. C. Rocha, and J. S. Martinez. Elastin-like Polymers for Stimuli-Responsive Opto-Electronic Materials. Presented at Materials Research Society (MRS) Spring Meeting. (San Francisco, CA, April 1-5, 2013).

Balog, E. R., K. Ghosh, Y. Park, V. Hartung, P. Sista, R. C. Rocha, H. L. Wang, and J. S. Martinez. Optical properties of a pH-sensitive phenylene vinylene oligomer in a thermosensitive biopolymer hydrogel context. *J. Phys. Chem. Lett.*

Ghosh, K., E. R. Balog, J. S. Martinez, and R. C. Rocha. Optical and Redox Properties of Novel Conjugates from Elastin-Like Polypeptides and Photoactive Transition-Metal Complexes. Presented at Materials Research Society (MRS) Spring Meeting. (San Francisco, CA, April 1-5, 2013).

Ghosh, K., E. R. Balog, J. S. Martinez, and R. C. Rocha. Metal-Biopolymer Assemblies and Composites From Elastin-like Polypeptides. Presented at Gordon Research Conferences - Polymers Conference. (South Hadley, MA, June 9-14, 2013).

Ghosh, K., E. R. M. Balog, J. S. Martinez, and R. C. Rocha. Integrated metallo-biopolymer assemblies from ELPs and photoactive metal complexes: photoluminescence modulation in coacervate microenvironments. *Biomacromolecules*.

Ghosh, K., E. R. M. Balog, P. Sista, D. J. Williams, D. Kelly, J. S. Martinez, and R. C. Rocha. Temperature-dependent morphology of hybrid nanoflowers from elastin-like peptides (feature article). 2014. *APL Mater.* 2: 021101.

Ghosh, K., E. R. M. Balog, P. Sista, J. S. Martinez, and R. C. Rocha. Creating functional hybrid materials by assembling metallo-biopolymers from elastin-like polypeptides. Presented at Mesoscale Science Frontiers. (Santa Fe, NM, May 13-16, 2014).

Ghosh, K., E. R. M. Balog, P. Sista, J. S. Martinez, and R. C. Rocha. Functional hybrid materials by assembling metallo-biopolymers. Presented at American Chemical Society (ACS) Fall Meeting. (San Francisco, CA, August 10-14, 2014).

Ghosh, K., E. R. M. Balog, P. Sista, J. S. Martinez, and R. C. Rocha. Elastin-like polypeptides functionalized with terpyridines: a novel "plug-and-play" approach to luminescent biomaterials. *Biomaterials Sci.*

Sista, P., K. Ghosh, J. S. Martinez, and R. C. Rocha. Polythiophenes in biological applications. 2014. *J. Nanosci. Nanotech.* 14: 250.

Sista, P., K. Ghosh, J. S. Martinez, and R. C. Rocha. Metallo-biopolymers: conjugation strategies and applications. 2014. *Polymer Rev.* 54: 627.

Tuned Optical Properties of Low-Dimensional Carbon Nanomaterials for Energy Harvesting

Stephen K. Doorn
20120766PRD3

Abstract

Fine tuning of graphene/CNTs with well-designed chemical functionalization would open up a pathway for incorporation of these materials into large area, inexpensive, flexible energy harvesting electronics. In this project, we gained fundamental understandings on their optically excited states and relaxation dynamics, which contributed in clarification of the competition between charge and energy transfer and recombination in these materials. The obtained information is crucial in determining their potential for photovoltaics thus providing insights into design of novel energy harvesting devices utilizing the unique optical properties of low-dimensional carbon nanomaterials.

Background and Research Objectives

Low-dimensional carbon nanomaterials such as graphene and carbon nanotubes (CNTs) offer intriguing optical properties which can potentially be incorporated into energy harvesting applications. However, their implementation requires in-depth understandings of the materials' optical properties such as the fundamental nature of the optically excited states and their relaxation dynamics. Furthermore, tuning of these states by chemical doping will provide flexibility to device design. The primary aim of this research was to evaluate the potential of oxygen doping of these materials for charge/energy transfer processes at the core of photovoltaic needs by first understanding the nature of their optical states, and to demonstrate their ideal chemical structures for photovoltaics. We aimed to answer the question: "Can effective functionalization strategies lead to unique optical properties of graphene oxide and CNTs for energy harvesting applications?"

More specifically, with similar origins for optical properties based in oxygen doping, optical properties of graphene oxide (GO) and oxygen doped nanotubes may display parallel behaviors that lead to better understanding of optical response in both. We planned to perform

steady-state and time-resolved optical studies on these materials. Our objective was defining how chemical modification alters optical response. Direct imaging and spectroscopy at the single nanotube and even dopant-site level was planned to clarify the surface mobility of oxygen dopants, how these states interact with the mobile excitons, and what are their surface dynamics.

Scientific Approach and Accomplishments

Our two research thrusts of i) graphene and ii) CNTs (carbon nanotubes) were conducted in parallel to facilitate the understanding of the underlying origin of the oxygen doping induced optical states in low-dimensional carbon nanomaterials. Details of scientific approach and accomplishments made for each thrust are as follows:

Graphene

Based on the results we obtained on graphene oxide (GO) single nanosheet optoelectronic devices in the first year of the project, we have shifted our focus on slightly different two-dimensional atomically-thin nanomaterials called transition metal dichalcogenides (TMDs). There was no change in the goal of the project, which is to understand the core photophysics of the low-dimensional nanomaterials during energy harvesting device operations. However, we have chosen TMDs as materials of our focus due to their intrinsic band gap in the visible wavelength range in sharp contrast to graphene based materials such as GO. The presence of appropriate band gaps that aligns well with the solar spectrum is ideal materials property for energy harvesting devices such as photovoltaics (PVs). State-of-the-art electron beam lithography and thin film metal deposition capabilities at the Center for Integrated Nanotechnologies (CINT) were used for the fabrication. Single nanomaterial device fabrication requires time and effort compared to the assembled film counterpart; however, the obtained information is free from averaging effects, which is essential for the fundamental study of the device. Device characterization using Scanning Photocurrent Microscopy

(SPCM) provided photocurrent distribution of the material with high spatial resolution. The SPCM characterization was then correlated with complementary optical properties such as photoluminescence (PL) mapping measured at the same positions. The results showed clear correlations which gives us insight as to how to design efficient low-dimensional atomically-thin nanomaterials based energy harvesting devices including PVs. Specifically, regions of strong photocurrent intensity matched well with two ends of the areas producing high PL, indicating that the origin of photocurrent is most likely the region where Schottky barriers are formed between TMDs and the metal contact electrodes.

Carbon Nanotubes (CNTs)

We have obtained detailed understanding of the fundamental nature of unique CNT optical properties achieved via controlled oxygen doping. More specifically, we have performed low temperature PL studies on individual oxygen-doped SWCNTs and correlated with electronic structure simulations (collaborative work with MPA-CINT and T division scientists at LANL). We demonstrated that different chemical adducts can co-exist on a single SWCNT (ether-d, ether-l and epoxide-l) and that each of them yield sharp emission peaks from localized deep trap states pinned at the dopant sites with different potential depths and stability/abundance. Additionally, oxygen doping brightens dark states near the E11 state through defect-induced symmetry breaking. Interaction between pinned excitons and one dimensional phonons leads to asymmetric broadening of deep trap emission peaks. Exciton pinning also increases the sensitivity of the deep trap to the local dielectric environment, leading to a large inhomogeneous broadening. More importantly, our study provided conclusive evidence that oxygen dopants indeed create traps deep enough for localizing excitons at room temperature. This localization prevents non-radiative collisional recombination of excitons. Emission of photons from such localized states could particularly be useful for room temperature single photon generation. These findings and analyses bring a new level of understanding to the electronic structure and chemical nature of oxygen dopant states, thus laying the foundation to utilize doping as a generalized route for wavefunction engineering and direct control of carrier dynamics in SWCNTs, with a view toward enhanced light emission properties for photonic applications including low-dimensional carbon based energy harvesting devices.

Impact on National Missions

Fundamental understandings on optically excited states and relaxation dynamics of chemically functionalized low-dimensional carbon nanomaterials that were gained in this project made significant contributions in clarifying

the competition between charge and energy transfer and recombination in these materials, which is crucial in determining their potential for photovoltaics. The results provide insights for design of novel energy harvesting devices utilizing the unique optical properties of low-dimensional carbon nanomaterials, and makes an important contribution to LANL's mission on sustainable energy as well as to the world's energy needs. The same insights apply to sensor materials for a number of national security missions.

Publications

Yamaguchi, H., J. Grantrom, W. Nie, G. Gupta, D. Viory, and M. Chhowalla. Reduced graphene oxide thin films as ultrabarrriers for organic electronics. 2014. *Advanced Energy materials*. 4: 1300986.

Enhanced Structural Robustness in Metal/Nonmetal Nanocomposites using Bio-inspired Structure Design

Nathan A. Mara
20120769PRD3

Abstract

Nature is full of inspiring examples for nano-composites that combine organic and inorganic components to build hard tissues like bone, enamel and mollusk shells. These biological systems have an inherent higher structural robustness, often despite the brittle nature of their constituents. Their remarkable robustness stems from the inelastic deformation of the organic phase that allows the material to redistribute the stress around the strain concentration sites (such as a notch or defect in the composite). This renders the material 'notch insensitive' thus preventing their unpredictable failure from imperfections. In the last 2 years of my LANL Director's Postdoctoral Fellowship we studied metal-nonmetal nanocomposite systems following biologically-inspired design that would exhibit a considerably improved mechanical performance, beyond the limits imposed by traditional disciplines. Recent work at LANL had already demonstrated the significantly higher flow strength and ductility of metal (Cu)-nonmetal (Pd-Si metallic glass) nanolaminate composites, which can be deformed to layer thickness reductions greater than 75% by cold rolling or bending, and exhibit high flow strengths (≈ 900 MPa) with only 10 volume% of glass and tensile ductility of 3%. A bio-inspired layered sandwich design of these structures (current approach at LANL) is expected to result in a significant enhancement in their fracture toughness without compromising the strength. Such nanocomposites were synthesized using physical vapor-deposition techniques using systems such as copper metal and titanium nitride (TiN) ceramic amorphous. Novel nanoindentation techniques were developed to understand the mechanical response of such layered materials. A key parameter explored was the measurement of crack growth resistance in these structures, which was achieved through micro-scale notched bending tests. A basic understanding of the processing-structure-property relationship and deformation and fracture mechanisms were explored.

Background and Research Objectives

This report is divided into two parts. The first part discusses the synthesis of the layered nanocomposites of a metal (copper) and a non-metal (titanium nitride (TiN)) using physical vapor deposition techniques following bio-inspired design of sandwich structures. This part also includes the initial microscale mechanical characterization of these nano layered composites.

A major accomplishment of this project was the development of novel techniques for investigating the mechanical response of materials at very low (micrometer to sub-micrometer) length scales. This is detailed in the second part of this report, which describes a unique method of characterizing the local mechanical behavior of layered materials using spherical nanoindentation stress-strain curves.

Scientific Approach and Accomplishments Grain size dictates strength in nanocrystalline Cu-TiN multilayered nano-composites.

A primary scientific interest in nanolayered composites stems partly from the fact that their constituent phases present large differences in strength, elastic modulus and ductility. In particular, it is of great interest to explore the possibility of enhancing the strength of the composite by the inclusion of a ceramic material, while retaining some amount of ductility from the metallic phase. A further motivation stems from prior research in metal-metal nano-layered composites where the composites recorded extraordinary strengths and ductility when the layer thickness is of the order of a few nanometers. At these length scales, the interfaces between the two materials constituting the multilayer assume an increasingly important role in determining the mechanical behavior as they comprise a more significant volume fraction of the multilayer [1].

Typically a decrease in the layer thickness is expected to strengthen the mechanical strength of the composite.

There are however no relevant studies on how these relationships may change if there exists a lower (than h) length scale of interest in these materials, such as a lower grain size, inclusions, precipitates etc. This motivates the present study where we investigate the mechanical behavior of a metal ceramic Cu-TiN multilayer system as a function of its decreasing layer thickness, but with the added caveat that the grain size in both the Cu and TiN this system is nano-crystalline, and smaller than the layer thicknesses studied.

Unlike Al-TiN samples reported earlier in [2], the Cu-TiN samples do not show any prominent columnar structure (Figure 1). Instead the grains are observed to be nanocrystalline and the grain size is typically smaller than the layer thickness. Note that the grain sizes are the smallest length scale of interest in the samples, i.e. they are smaller than the measured individual layer thicknesses.

These observations are in sharp contrast to those reported for Al-TiN, where the multilayers showed grain sizes of 75-120 nm for a 9 nm thick Al layer, which increases to 0.3-0.6 μm as the Al layer thickness increases to 250nm [2]. Thus for the Al-TiN multilayer system the smallest length scale of interest is expected to be the layer thickness, which is significantly smaller than the Al grain size.

Two features are apparent when comparing the hardnesses of Al-TiN vs. Cu-TiN in Figure 2: (i) the Al-TiN samples show a Hall-Petch-type dependence of hardness on the bi-layer thickness for $\lambda \geq 50$ nm. (ii) On the other hand the Cu-TiN samples show an almost constant value of hardness, around 5 GPa, irrespective of the bi-layer thickness.

The uniaxial compression responses of Cu-TiN and Al-TiN (Figure 2b and 2c) show a trend similar to the hardness values. Thus the flow strengths of the Cu-TiN multilayers remain more or less constant (2.5-2.9 GPa) as the individual layer thicknesses are changed from 5 to 50 to 100 nm. On the other hand the Al-TiN multilayers show an almost 1 GPa increase (from 2.5-2.7 GPa to 3.5-3.6 GPa) as the layer thickness decreases from 50 nm to 5 nm.

The in-situ observations in SEM during the micro-compression experiments show the following features for the thicker Cu (100 nm) – TiN (100 nm) and Cu (50 nm) – TiN (50 nm) layer thickness micro-pillars the following observations can be made from the in-situ movies: (i) The thicker Cu (100 nm) – TiN (100 nm) pillars show a predominantly elastic response up to a stress of ~ 2.6 GPa. Tests stopped at this point (Figure 2d) show that cracks have formed at the TiN layers at these stresses. (ii) The observations are strikingly different for the thinner Cu (5 nm) – TiN (5 nm) micro-pillars (Figures 2f and 2g). In this case no cracks are visible till $\sim 30\%$ strain. Other tests done to higher strain

levels do not show any visible cracks till $\sim 50\%$ strain, whence significant barreling has already occurred. In all these tests the highest stresses reached are ~ 2.9 GPa at around 1% strain. At these stresses the Cu (5 nm) – TiN (5 nm) pillar deforms by the formation of a shear band, and the deformation behavior is reminiscent of plastic flow of a metallic pillar. The formation of the shear band and the extensive plastic deformation of the thinner Cu (5 nm) – TiN (5 nm) micro-pillars are suggestive of a co-deformation response between the metal and ceramic components in this system.

Both the hardness measurements and the micro-compression flow strengths in Cu-TiN indicate a lack of any strengthening mechanisms in this system as their layer thicknesses are decreased. This is in sharp contrast to the Al-TiN system where we observe a Hall-Petch-type behavior at larger bi-layer thicknesses $\lambda \geq 50$ nm and possible confined layer slip of dislocations below $\lambda < 50$ nm [2]. These findings suggest that there is lower length scale of interest in the Cu-TiN samples, which is expected to be the nano-crystalline grain size in these samples as shown in the TEM micrographs. This study thus points to the importance of accounting for features such as the grain size in these layered materials when attempting to explain their mechanical response.

Probing nanoscale damage gradients with spherical nanoindentation

Materials with modified surfaces – either as a consequence of a graded microstructure, or due to an intentional alteration of the surface such that its physical, chemical or biological characteristics are different that the bulk of the material – are of increasing interest for a variety of applications ranging from enhanced wear and corrosion resistance, superior thermal and biomedical properties, higher fracture toughness, and reduced stress intensity factors etc. [3]. Quantifying the resulting property gradations poses a significant challenge, especially when the changes occur over small (sub-micrometer) depths. In this chapter we present a novel indentation approach which, together with the corresponding local structure information obtained from electron backscatter diffraction (EBSD), allows us to probe nanoscale surface modifications in solid materials and quantify the resulting changes in its mechanical response.

Among the experimental techniques available at these length scales, nanoindentation, with its high resolution load and depth sensing capabilities, shows the greatest promise due to its non-destructive nature, ease of experimentation (only a polished surface prior to ion irradiation is needed) and versatility [4]. In particular, using spherical indenters, our recent work [5] has demonstrated the feasi-

bility of transforming the raw load-displacement data into meaningful indentation stress-strain curves. These indentation data analyses methods have captured successfully the local loading and unloading elastic moduli, the local indentation yield strengths, and certain aspects of post-yield strain hardening behavior in various polycrystalline metal samples. More specifically, the use of these indentation stress-strain curves makes it possible to analyze the initial loading segments of spherical indentation – before the indentation itself imposes additional local plastic deformation and alters the local microstructure and its properties. This has enabled the measurement of the local indentation yield strengths in individual grains of deformed polycrystalline metallic samples [6], and across their grain boundaries [7], which in turn can be related to percentage increases in the local slip resistances from their fully annealed conditions. Here, we apply these methods to indentations on ion-irradiated metallic materials, and compare their relative mechanical behavior to the unirradiated state.

One of the main advantages of nanoindentation techniques is that it allows a systematic study of the local mechanical responses at different length scales, accomplished by simply varying the indenter tip radii. As an example the table in Figure 3d shows the approximate indentation depth (h_t) and the corresponding contact radius (a) and the depth of the indentation zone (which scales as $2.4a$) at yield in annealed tungsten for 4 different indenter radii. A proper choice of indenter size can thus match the volume probed by nanoindentation (Figures 3a and 3b) to the depth of radiation-damaged (or any other surface-modified) region of interest (Figure 3c). Furthermore, the ability to make a large number of measurements on a given sample surface also has the potential to provide quantitative information on the variance of properties in the irradiated layer.

Figures 4a-4c show spherical nanoindentation measurements reported recently [8] on annealed (not irradiated) and He ion-irradiated samples of electro-polished tungsten using indenters tips of different radii. All of the measurements reported in these figures were for grains whose surface normals were very close to [100] directions. These grains were purposely selected to avoid the need to correct for the effect of the lattice orientation at the indentation site in comparing the different measurements presented in these plots

The indentation stress-strain curves from the irradiated samples revealed several interesting features. Strikingly, none of the measurements (including the measurement with the smallest indenter tip $R_i = 1 \mu\text{m}$, Figure 4a) revealed any pop-ins (cf. the measurements on the annealed samples which clearly show pop-ins for the measurements

with the smaller indenters). This is consistent with the expectation that the ion-irradiation introduces a large density of defects in top surface of the material (e.g., radiation induced defects such as dislocation loops, He bubbles, etc.) that can help set up highly potent dislocation sources without any need for pop-ins. Another obvious consequence of these new defects introduced by irradiation is that the Y_{ind} values in the irradiated samples are higher than the corresponding values in the annealed samples.

As mentioned earlier, upon ion-irradiation the metal surface is modified by a thin radiation-damaged layer (see Figure 3a), and investigations with different indenter radii can help ascertain the depth and severity of this damage. The post-yield measurements on the He-irradiated near (001) grain with the $1 \mu\text{m}$ radius indenter tip (see Figure 4a) indicate a zone of very high strain hardening (within a short range 0.03-0.1 of indentation strains) followed by a regime of near stress saturation [9] with a slight softening in stress from 11.6 to 10.5 GPa. The contact radius in this test was estimated to range from $\sim 32 \text{ nm}$ at Y_{ind} to $\sim 200 \text{ nm}$ at an indentation strain of 0.1 (end of hardening zone) to $\sim 500 \text{ nm}$ at the end of the test (indentation strain of 0.2). The indentation stresses at a $\sim 500 \text{ nm}$ were still significantly higher (10.5 GPa) in the irradiated sample as compared to the annealed material (6.2 GPa) tested with the same indenter. These observations indicate that the damage layer due to irradiation extends to depths of the order of 500 nm (assuming that the active indentation zone size is at least of the order of the contact radius a , see Figures 3a-c). On the other hand, the corresponding measurements with the $R_i = 10 \mu\text{m}$ indenter tip (Figure 4b) show an initial post-elastic zone of a high strain hardening (from an indentation strain of 0.02 to 0.045) followed by a regime of marked softening. Intriguingly, the softening regime brings the indentation stress values in agreement with the values measured with the same indenter on the annealed samples. These measurements suggest that the initial hardening regime for the $R_i = 10 \mu\text{m}$ indenter is attributable to the plastic deformation induced by the indenter in the irradiated top layer, while the later softening regime is attributable to the expansion of the plastic zone to the undamaged annealed region below the irradiated top layer. Support for this hypothesis comes from the estimated values of the contact radius in this measurement. The contact radius for the $R_i = 10 \mu\text{m}$ indenter after irradiation is estimated to be $\sim 260 \text{ nm}$ at Y_{ind} , $\sim 500 \text{ nm}$ at the peak indentation stress level, and $\sim 1.5 \mu\text{m}$ at the end of the test (Figure 4b). These measurements suggest that the irradiated layer in this sample is of the order of 500 nm.

The measurements shown in Figures 3-4 demonstrate the viability and tremendous potential of the spherical inden-

tation stress-strain curves in investigating the changes in the mechanical response of nuclear materials with radiation-damage.

Impact on National Missions

The work done in this project is directly aligned with the grand challenges and scientific issues outlined in the BESAC report of DOE, Office of Science titled “Directing matter and energy: five grand challenges for science and the imagination” and the Basic Research Needs (BRN) workshop series, specifically: Advanced Nuclear Energy Systems (ANES); and Materials Under Extreme Environment (MUEE).

Some specific scientific questions from these reports that are pertinent to this LDRD project are:

- How do we make hard matter that heals damage or defects?
- How mechanically strong can we make materials yet keep them light-weight?

Development of scientific principles of designing materials from the atomic scale for predictable performance at extreme conditions such as high stress, high radiation dose, etc. also supports the mission of LANL’s MARIE and DOE-NE.

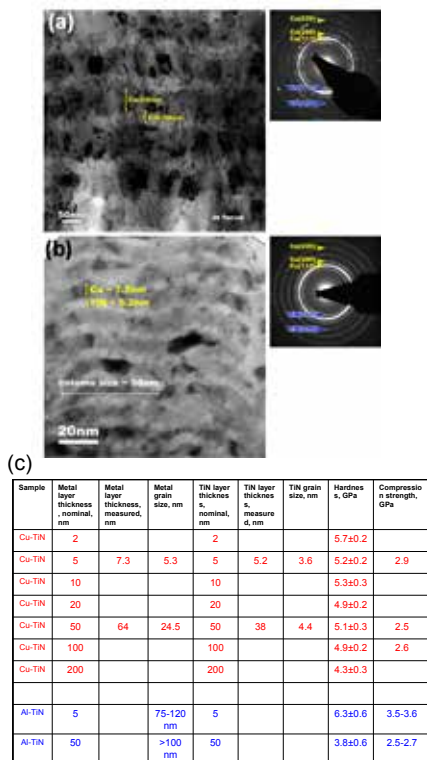

Figure 1. Cross-sectional TEM of the (a) Cu (50 nm) – TiN (50 nm) sample and (b) Cu (5 nm) – TiN (5 nm) sample with corresponding diffraction patterns from the same films. (c) Microstructural details and measured mechanical properties of the Cu-TiN and Al-TiN multilayered films.

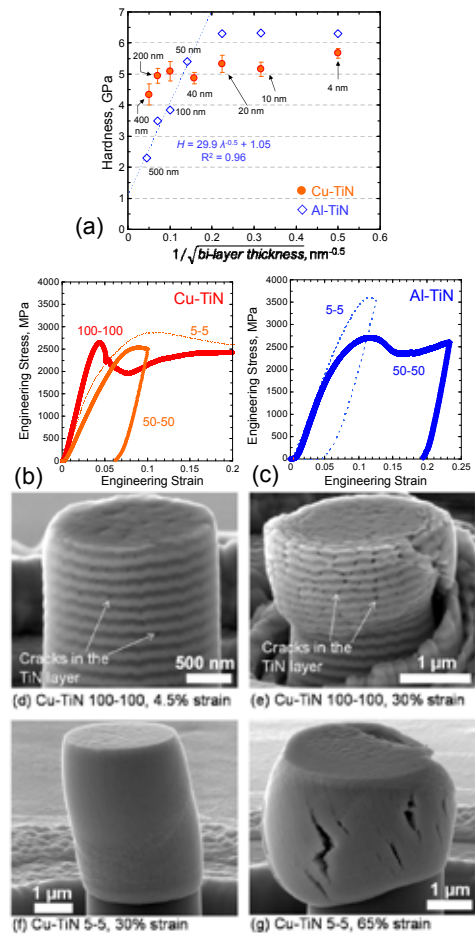

Figure 2. (a) Hardness vs. (bilayer thickness) for Cu-TiN (orange filled circles) and Al-TiN (blue open diamonds). The bilayer thickness values are marked for each data point. Comparison of the uniaxial compression response between (b) Cu-TiN and (c) Al-TiN as a function of varying layer thicknesses. Micrographs taken from the SEM micro-compression experiments showing the deformation morphology of (d) and (e) the thicker Cu (100 nm) – TiN (100 nm) micro-pillars and (f) and (g) thinner Cu (5 nm) – TiN (5 nm) micro-pillars at varying strain levels.

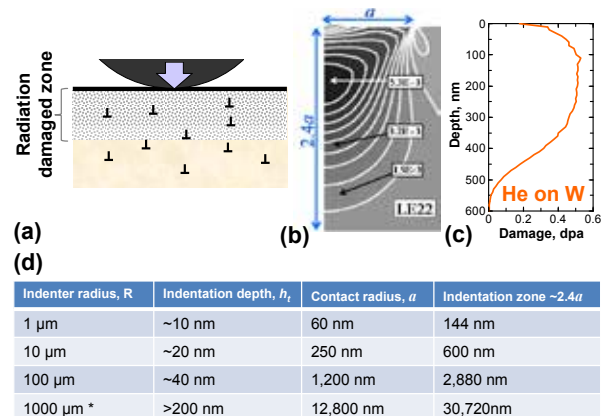

Figure 3. (a) Upon ion-irradiation, the metal surface is modified by a damaged layer, which causes a change in its mechanical response as compared to the bulk of the sample. (b) Logarithmic strain field (along the indentation direction) for a spherical

indenter in the indentation zone (~ 2.4 , where a is the contact radius) close to the indentation yield. Both the contact radius, and hence the volume probed by indentation, can be controlled with a proper choice of indenter radii. This approach is thus ideally suited for measuring any mechanical changes in the material surface layers, such as probing the (c) damage caused by He irradiation on a tungsten sample. (d) Table showing indentation depth (h), contact radius (a) and indentation zone size ($\sim 2.4a$) at yield for W using 4 different indenter radii.

* For the 1000 μm radius indenter, the response was all elastic up to $h \sim 200\text{nm}$ (instrument limit).

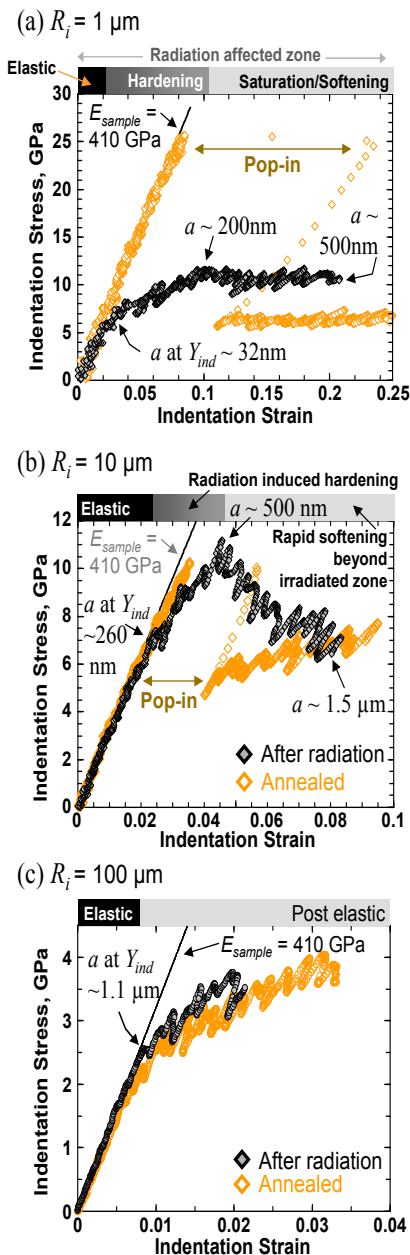

Figure 4. Comparing the indentation stress-strain responses between annealed (orange curve) and irradiated (black curve) W grains of near (001) orientation for three different indenter tip radii (a) 1 μm , (b) 10 μm and (c) 100 μm .

References

- Misra, A., J. P. Hirth, and R. G. Hoagland. Length-scale-dependent deformation mechanisms in incoherent metallic multilayered composites. 2005. *Acta Materialia*. 53 (18): 4817.
- Bhattacharyya, D., N. A. Mara, P. Dickerson, R. G. Hoagland, and A. Misra. Compressive flow behavior of Al-TiN multilayers at nanometer scale layer thickness. 2011. *Acta Materialia*. 59 (10): 3804.
- Suresh, S.. Graded materials for resistance to contact deformation and damage. 2001. *Science*. 292 (5526): 2447.
- Hosemann, P., D. Kiener, Y. Wang, and S. Maloy. Issues to consider using nano indentation on shallow ion beam irradiated materials. 2012. *Journal of Nuclear Materials*. 425 (1-3): 136.
- Kalidindi, S. R., and S. Pathak. Determination of the effective zero-point and the extraction of spherical nanoindentation stress-strain curves. 2008. *Acta Materialia*. 56 (14): 3523.
- Pathak, S., D. Stojakovic, and S. R. Kalidindi. Measurement of the Local Mechanical Properties in Polycrystalline Samples Using Spherical Nano-Indentation and Orientation Imaging Microscopy. 2009. *Acta Materialia*. 57 (0): 3020.
- Pathak, S., J. Michler, K. Wasmer, and S. R. Kalidindi. Studying grain boundary regions in polycrystalline materials using spherical nano-indentation and orientation imaging microscopy. 2012. *Journal of Materials Science*. 47 (2): 815.
- Pathak, S., S. R. Kalidindi, Y. Wang, R. Doerner, and N. A. Mara. Probing nanoscale damage gradients with spherical nanoindentation. *Nano Letters*.
- Patra, A., and D. L. McDowell. A void nucleation and growth based damage framework to model failure initiation ahead of a sharp notch in irradiated bcc materials. To appear in *Journal of the Mechanics and Physics of Solids*.

Publications

- Pathak, S., J. Riesterer, S. R. Kalidindi, and J. Michler. Understanding pop-ins in spherical nanoindentation. 2015. *Applied Physics Letters*. 105 (16): 161913.
- Pathak, S., S. R. Kalidindi, Y. Wang, R. Doerner, and N. A. Mara. Probing nanoscale damage gradients with spherical nanoindentation. *Nanoscale*.

Pathak, S., and S. Hutchens. Vertically aligned carbon nanotubes, collective mechanical behavior. 2014. In Encyclopedia of Nanotechnology. By Bhusan, B., p. 2809. Ireland: Springer.

Pathak, S., and S. R. Kalidindi. Indentation stress strain curves – Review paper. To appear in Materials Science and Engineering - R.

Materials for the Future

Postdoctoral Research and Development
Final Report

Photoactive Energetic Materials for Quantum Optical Control

Sergei Tretiak
20130804PRD3

Abstract

Our theoretical development has allowed us to simulate large molecular systems where full ab-initio calculations are prohibitively expensive, and to describe systems that interact strongly with solvent environments. Such simulations have been done previously for the ground state but were never attempted for excited states due to computational complexity. Thus this work increases the controllability of chemical dynamics by predicting and controlling the functionality of materials.

Background and Research Objectives

Understanding and controlling excited state dynamics (spatial energy transfer, excitation localization/delocalization, and/or charge separation) lies at the heart of all our efforts to design photoactive materials with desired functionality. Excited states have varying electron-phonon couplings, and depending on their localization and energy, lead to different relaxation pathways. This structure provides a “landscape” for optical control (steering the outcome of a chemical reaction with light) based on which excitations are selected. Non-adiabatic excited-state molecular dynamics (NA-ESMD) simulations provide a detailed understanding of key photoinduced phenomena controlling competing interactions and relaxation pathways in complex materials. The overarching goal of the project is to develop a combined quantum mechanical and molecular mechanical approach to treat large systems and include solvent and thermal bath effects and to apply this method to multiple molecular systems.

Scientific Approach and Accomplishments

During 8 mos. of project duration, significant changes were done to the underlying codes toward implementation of solvent contributions. In particular, several new algorithmic developments were accomplished. For example, so-called min-cost algorithm was implemented and was tested on several molecular systems [1]. This

allowed us to avoid artifacts in the modeling of excited state non-adiabatic dynamics in the regions congested with the high density of excited states [1].

Impact on National Missions

Our implementation of a combined quantum mechanical and molecular mechanical (QM/MM) approach provided novel computational capabilities critical for understanding light-induced dynamics in many technologically relevant materials. Overall our work has advanced LANL's expertise in quantum control and molecular design.

References

1. Nelson, T., S. Fernandez-Alberti, A. E. Roitberg, and S. Tretiak. Artifacts due to trivial unavoided crossings in the modeling of photoinduced energy transfer dynamics in extended conjugated molecules. 2013. CHEMICAL PHYSICS LETTERS. 590: 208.

Publications

- Nelson, T., S. Fernandez-Alberti, A. E. Roitberg, and S. Tretiak. Artifacts due to trivial unavoided crossings in the modeling of photoinduced energy transfer dynamics in extended conjugated molecules. 2013. CHEMICAL PHYSICS LETTERS. 590: 208.

Poly-Triphenylamine-Functionalized Graphene Quantum Dots for Flexible High-Performance Polymeric Memory Devices

Hsing-Lin Wang
20130806PRD3

Abstract

Polymeric memory materials store information in the form of high (ON) and low (OFF) current states instead of the charge state stored in silicon memory devices and possess the advantages of low-cost, solution processability, flexibility, and three-dimensional stacking capability for practical utilization. [1,2] In this proposal, we strive to achieve synthesis of polymers consisting of nanographene whose optical and electronic properties are tunable depending on the nanographene size, molecular structures and heteroatom incorporation. The as-synthesized polymers are tailored to have electronic structures that exhibit volatile and non-volatile memory properties.

Background and Research Objectives

Graphene, which consists of atom-thick sheets of carbon organized in a honeycomb structure that resembles chicken wire, has attracted tremendous attention from both academic and industrial sectors due to its long-range-conjugation, yielding extraordinary thermal, mechanical, and electrical properties. In recent years, some simple electronic devices based on graphene have been fabricated. However, graphene tends to aggregate in solution and in the solid state, giving rise to a great technical challenge in the fabrication of graphene-based devices by spin- or blade-coating a solution in organic/aqueous solvent.

On the other hand, quantum confinement and edge effects are found to be more pronounced in nanographenes (NGs) from which many new fascinating phenomena are expected. NGs have been successfully prepared by various methods. However, depending on the synthesis, the physical properties of NGs vary widely; thus, their application in optoelectronic devices have become a great challenge. The major area where NG has shown promise is luminescent materials [3,4] for bioimaging, single electron transistors, light-harvesting assemblies, and electron-transporting materials in photovoltaic

devices. The size-dependent band gap of graphene and large optical absorptivity are particularly interesting for its application as a photosensitizing material in photovoltaic devices.

Recently, polymeric memory materials have achieved dramatic progress since first reported by Sliva et al. in 1970. [5] Compared with conventional inorganic memory materials, polymeric materials offer advantages in their ease of miniaturization and tailorable energy levels through structural design. [6] Moreover, polymeric memory materials store information in the form of high (ON) and low (OFF) current states instead of the charge state stored in silicon memory devices and possess the advantages of low-cost, solution processability, flexibility, and three-dimensional stacking capability for practical utilization. In this project, we sought to synthesize polymers consisting of nanographene whose optical and electronic properties are tunable depending on the nanographene size, molecular structures and heteroatom incorporation. The as-synthesized polymers are tailored to have electronic structures exhibiting volatile and non-volatile memory properties.

Scientific Approach and Accomplishments

We have synthesized a series of novel triaryl amine (TAA), which consisting of nanographene flakes (Figure 1). The synthesis of TAA is through a multi-step organic synthesis; we start with halogenation of triphenyl amine, follow by Sonogashira coupling reaction, Diels Alder reaction and then Suzuki coupling reactions. This will lead to TAA dendritic precursor, which was then exposed to an excess of FeCl₃ in a dichloromethane/nitromethane mixture, yielding the TAA-based nanographene. The structures and properties of the completely fused TAA have been determined by X-ray, 2D X-ray, MALDI-TOF MS, UV-Vis, fluorescence and FT-IR spectroscopy. These novel TAAs reveal crystalline structures resulting from self-assembly driven by pi-pi interaction between two nanographene flakes. We have also demonstrated po-

tential applications of these new materials toward optical and energy devices.

In addition, we have demonstrated prove-of-principle that 2D conjugated polymers consisting of donor and acceptor in the polymer backbone can be used for memory device applications. Combined theoretical and experimental studies of our donor-acceptor conjugated systems, similar to the proposed nanographene systems, reveal volatile and non-volatile memory properties by rational design of molecular structures with desired electronic properties. We have demonstrated a strong correlation between resistive switching properties and molecular structures through controlling the stability of the charge transfer (CT) complex. Our results suggest the feasibility of tailoring the memory device properties through controlled synthesis of conjugated systems with backbone and side chains allowing fine-tuning the energetics and degree of conjugation. This work has been published and featured in *Journal of Materials Chemistry* as back cover article.

Impact on National Missions

Our proposed synthesis promise ways to control NGs with size-dependent band gap, optical absorptivity, and charge transfer functionality. Success of this proposal is likely to generate a new class of exotic materials with emergent functionality previously not accessible through fabrication methods. The integration of functional NGs into clean energy technologies could bridging the gap between basic research and commercialization of graphene based energy devices. Further developing NG and NG-based materials will strengthen our leadership role in NG research, which has strong ties to laboratory missions in the areas of exotic materials and energy security.



Figure 1. Synthetic scheme of triarylamine (TAA) consists of three nanographene flakes.

References

1. Yu, A. D., T. Kurosawa, Y. C. Lai, T. Higashihara, M. Ueda, C. L. Liu, and W. C. Chen. Flexible polymer memory devices derived from triphenylamine-pyrene containing donor-acceptor polyimides. 2012. *Journal of Materials Chemistry*. 22 (38): 20754.
2. Islam, S. M., P. Banerji, and S. Banerjee. Electrical bistability, negative differential resistance and carrier transport in flexible organic memory device based on polymer bilayer structure. 2014. *Organic Electronics*. 15 (1): 144.
3. Liu, Y., C. Y. Liu, and Z. Y. Zhang. Synthesis of highly luminescent graphitized carbon dots and the application in the Hg²⁺ detection. 2012. *Applied Surface Science*. 263: 481.
4. Lin, L. P., M. C. Rong, F. Luo, D. M. Chen, Y. R. Wang, and X. Chen. Luminescent graphene quantum dots as new fluorescent materials for environmental and biological applications. 2014. *Trends in Analytical Chemistry*. 54: 83.
5. Sliva, P. O., G. Dir, and C. Griffiths. Bistable switching and memory devices. 1970. *Journal of Non-Crystalline Solids*. 2 (0): 316.
6. Lin, H., W. Lee, and W. Chen. Selenophene-DPP donor-acceptor conjugated polymer for high performance ambipolar field effect transistor and nonvolatile memory applications. 2012. *Journal of Materials Chemistry*. 22 (5): 2120.

Publications

- Chen, C., H. Yen, Y. Hu, and G. Liou. Novel Programmable Functional Polyimides: Preparation, Demonstrating Mechanism of CT Induced Memory, and Ambipolar Electrochromic Behavior. 2013. *J. Mater. Chem. C*.
- Chou, Y., H. Yen, C. Tsai, W. Lee, G. Liou, and W. Chen. Non-volatile transistor memory devices using high dielectric constant polyimide electrets. 2013. *J. Mater. Chem. C*. 1 (19): 3235.
- Yen, H., J. Wu, W. Wang, and G. Liou. High-Efficiency Photoluminescence Wholly Aromatic Triarylamine-based Polyimide Nanofiber with Aggregation-Induced Emission Enhancement. 2013. *Advanced Optical Materials*. 1 (9): 668–676.



Nuclear and Particle Futures

Nuclear and Particle Futures

Directed Research
Continuing Project

Illuminating the Origin of the Nucleon Spin

Ivan M. Vitev
20130019DR

Introduction

Nucleons (protons and neutrons) are not fundamental constituents of matter, but are instead made up of quarks and gluons, the elementary particles of the strong interaction. There is compelling experimental evidence that the sum of the quark and gluon intrinsic angular momenta only contributes $\sim 1/3$ of the total proton spin. Thus, the majority of the proton spin is unaccounted for, which has been referred to as the “proton spin crisis”. The missing fraction of the spin is likely carried by the orbital angular momentum of the quarks and gluons. The long-term goal of this project is to develop the experimental capability to measure the spin of the proton in terms of contributions from the spins of the quarks, gluons and their orbital angular momentum. An equally important goal is to understand the relative significance of these spin contributions in the theory of strong interactions, Quantum Chromodynamics (QCD), and how they manifest themselves in reactions with polarized proton beams and/or targets. To this end, we will determine the momentum distribution of quarks inside the proton, transverse to the proton momentum, from which one can deduce whether quark orbital motion contributes significantly to the proton spin.

To determine the distribution of quarks and gluons within a nucleon, we will carry out the world’s first measurement of the production of two simultaneous leptons (electrons or muons) from a polarized proton target bombarded by a high-energy proton beam. From a detailed analysis of the azimuthal distribution of such di-leptons, one can deduce properties of the polarized nucleon structure. In particular, we will measure both the sign and magnitude of the quark Sivers distribution, which is expected to be zero if the quarks have no orbital angular momentum.

Benefit to National Security Missions

This work is central to the FY13, FY14 LDRD Strategic Investment Plan of Nuclear and Particle Futures. Build-

ing upon our existing strategic partnership with Fermilab (E906, MiniBoone and LBNE), this project will strengthen our fundamental science capabilities, bring new high-luminosity polarized target technology to LANL and provide a “major physics thrust to follow current commitments to RHIC”. This project will maintain LANL’s leadership position in the field of spin physics and produce the world’s most accurate polarized Drell-Yan measurement in proton-proton reactions. Our project is a timely and direct response to the DOE Mile-stone (HP13) to “test unique QCD predictions for relations between single-spin phenomena in p-p scattering and those observed in deep-inelastic scattering”. We anticipate that this LDRD project will result in DOE Office of Science funding for a LANL-lead spin physics program at Fermilab. Our integrated experimental and theoretical program will allow us to lead in a major advance in understanding the polarized nucleon structure through the only U.S.-based dedicated polarized DY experiment. Providing a polarized target to FNAL will greatly enhance Fermilab’s capabilities and provide a much needed user facility for spin physics. Our target will also be able to polarize ND₃, thus enabling one to extend the spin physics to polarized neutrons. Furthermore, developing and testing particle detector technology at high luminosity will directly benefit MaRIE, a LANL institutional priority. This detector development is also of fundamental importance to nuclear detection for applied missions like nuclear nonproliferation. Such detectors often operate in a high background environment.

Progress

Experimental Progress

During the current FY we tested the 140 GHz microwave tube at University of Virginia (UVa). The tests revealed that, while the tube is working, the power output is too low due to age. We have submitted a Purchase Order (PO) for a new tube. We have completed the technical evaluation of the pump package needed for the refrigerator and submitted a Purchase Request. As a result, a PO

has been awarded to Oerlikon-Leybold and the pumps will be in Los Alamos on 9/1/2014. The magnet is currently at Oxford Instruments and the Co-PI will visit Oxford June to finalize all the modifications necessary for refurbishing the magnet and change the orientation of the coils. We have modified the magnet power supply to adhere to today's electrical safety requirements and have successfully setup and furnished the Testlab for all the necessary work. We are currently in the process of setting up a Memorandum of Understanding (MOU), which will define the statement of work UVA will perform on the cryostat to modify it for the new magnet geometry. We have also purchased a chiller, which will be used to keep the microwave tube at constant temperature. During this FY we have completely redesigned the Nuclear Magnetic Resonance (NMR) system with state-of-the-art components and built a prototype. We will take this prototype to the UVA testlab in July and will test it with a polarized target under running conditions at 1K and 5T. We have setup collaboration with the University of Illinois and Fermilab to build a closed-loop Helium liquefier system, and University of Michigan which will provide us with a second microwave tube. We have held the first collaboration meeting at Fermilab (FNAL) and had an in-depth discussion with FNAL management, including the director, where we laid out the path forward.

Theoretical Progress

Kang, Vitev and Xing studied the Quantum Chromodynamics (QCD) evolution of the Sivers effect in both semi-inclusive deep inelastic scattering (SIDIS) and Drell-Yan production (DY). For the first time, we identified a suitable spin-independent non-perturbative Sudakov factor in the evolution formalism, which leads to a good description of the world's experimental data on the transverse momentum distributions in SIDIS, DY lepton pair, and W/Z production. With this Sudakov factor at hand, we performed a global fitting of all the experimental data on the Sivers asymmetry in SIDIS from HERMES, COMPASS and Jefferson Lab. We made detailed predictions for the Sivers asymmetry in DY lepton pair production in the kinematic region relevant to our DR experiment at Fermilab, that can be compared to the future data to test the sign change of the Sivers functions between SIDIS and DY processes and constrain the sea quark Sivers distribution. We developed a global fitting package, which could be used to analyze data in the future once it becomes available. Gupta, Yoon and external collaborators are calculating the Sivers and Boer Mulders transverse momentum distribution functions of the nucleon using simulations of Lattice QCD using clover-on-clover ensemble at a lattice spacing $a=0.11$ fm with pion mass of 330 MeV. These results will be compared with those from a domain wall-on-domain wall ensemble at $a=0.084$ fm and pion mass of 300 MeV. They are also

investigating (i) dilution, (ii) preconditioning using hopping parameter expansion, (iii) truncated solver method, (iv) isolation of low modes and (v) multigrid methods to improve the signal in the calculation of disconnected diagrams. Lee and collaborators published a rigorous proof of the equivalence of traditional perturbative QCD and soft-collinear effective theory (SCET) methods of resummation of large logarithms and new ways to improve the accuracy of predictions using both methods for cross sections in momentum-space, e.g. $e+e-$ event shapes or Drell-Yan k_T distributions. The paper was reviewed as "remarkable, likely to become a classic." Recently we hosted a student, Zhang (Arizona), with whom we showed that soft functions for $e+e-$ dijet event shapes, deep inelastic scattering (DIS) thrust, and Drell-Yan cross sections are equivalent to two loops. This makes possible up to next-to-next-to-next-to-leading logarithmic (NNNLL) resummed accuracy in predicting these cross sections.

Future Work

Experiment

The 5T superconducting magnet modifications will be completed at Oxford Instruments in the UK, shipped to the US and tested at LANL. The University of Virginia will construct and deliver the refrigerator and target stick to us, where it will be installed in the magnet. The ROOTS pump cooling system will be attached to the refrigerator. A 140GHz microwave system will be completed and attached to the target stick. The frozen ammonia target material will be irradiated at NIST. Then the assembly of the entire polarized target will be completed at LANSCE. Using our just completed NMR system, we will operate the polarized target and measure the proton polarization. Once a sufficiently high polarization can be maintained, the target system will be disassembled and shipped to Fermilab to be installed in the E906/1039 experimental hall. Several additional NMR modules will be produced and installed in the experimental hall.

Theory

We will implement QCD evolution and perform global analysis for the Collins spin asymmetry measured at SIDIS and $e+e-$ experiments. With a much larger range of Q^2 , we will be able to constrain better the evolution formalism and in turn give even more precise predictions for our DY experiments. We will continue to simulate and analyze 323×96 clover-on-clover ensemble generated at $a=0.11$ fm with $M_{\pi}=330$ MeV at JLab. These results will be compared with those from a 323×64 DWF-on-DWF ensemble at $a=0.084$ fm and $M_{\pi}=300$ MeV being simulated at NERSC. We will continue to develop and accelerate methods to calculate disconnected diagrams. We have established a collaboration with U. Arizona to push forward the applica-

tion of SCET Rapidity Renormalization Group techniques to transverse-momentum-dependent and generalized parton distribution functions. We will define and compute these PDFs in perturbation theory and study their evolution to at least next-to-leading-log accuracy and compare with pQCD and alternative approaches.

Conclusion

Through a synergy between theory and experiment, we will make a fundamental advance in our understanding of the origin of the nucleon spin. In a strategic partnership with Fermilab, we will carry out the world's most accurate measurement of di-lepton production from a polarized proton target bombarded by a high-energy proton beam. We will develop state-of-the-art theoretical and computational tools necessary to interpret the experimental results that will directly lead to a major breakthrough in our understanding of the structure of matter and the theory of strong interactions.

Publications

- Dai, L., Z. Kang, A. Prokudin, and I. Vitev. Next-to-leading Order Transverse Momentum-weighted Siverson Asymmetry in Semi-inclusive Deep Inelastic Scattering: the Role of the Three-gluon Correlator. *Physical Review D*.
- Echevarria, M.. QCD Evolution of the Siverson Asymmetry. To appear in QCD Evolution Workshop 2014. (Santa Fe, NM, 12-16 May, 2014).
- Echevarria, M., A. Idilbi, Z. Kang, and I. Vitev. QCD Evolution of the Siverson Asymmetry. 2014. *Physical Review D*. 89: 074013.
- Jian, X.. Single Spin Asymmetries of Inclusive Hadrons Produced in Electron Scattering from a Transversely Polarized ^3He Target. To appear in QCD Evolution Workshop. (Santa Fe, NM, 12-16 May 2014).
- Kang, Z.. Single transverse spin asymmetries in polarized SIDIS and pp scattering. Invited presentation at The 5th Workshop of the APS Topical Group on Hadronic Physics. (Denver, 10-12 April 2013).
- Kang, Z.. Nucleon spin: longitudinal, transverse, and evolution. Invited presentation at 2014 RHIC and AGS Annual Users Meeting. (Upton, NY, 17-20 Jun. 2014).
- Kang, Z. B., I. Vitev, and H. X. Xing. Transverse momentum-weighted Siverson asymmetry in semi-inclusive deep inelastic scattering at next-to-leading order. 2013. *PHYSICAL REVIEW D*. 87 (3): -.
- Klein, A.. An Experiment to Measure the Siverson Asymmetry of the Sea Quarks. To appear in QCD Evolution Workshop. (Santa Fe, NM, 12-16 May, 2014).
- Klein, A.. Drell Yan at FNAL with a Polarized Target. Invited presentation at DNP Fall Meeting. (Waikoloa, HI, 6-11 Oct. 2014).
- Klein, A., P. McGaughey, and I. Vitev. Letter of Intent for a Drell-Yan experiment with a polarized proton target. 2013. Fermilab PAC .
- Kleinjan, D., and A. Klein. A Polarized Drell-Yan experiment to probe the dynamics of the nucleon sea. Invited presentation at Diffraction 2014. (Primošten (Croatia), 10-15 Sept. 2014).
- Lee, C.. QCD Resummation: Comparing Direct and Effective Methods. Invited presentation at Boston Jet Workshop. (Boston, MA, 21-23 Jan. 2014).
- Lee, C.. Comparing and Counting Logs in Direct and Effective Methods of Resummation. Invited presentation at CET 2014. (Munich, Germany, 24-26 March, 2014).
- Lee, C.. The Evolution of Soft-Collinear Effective Theory. To appear in QCD Evolution Workshop. (Santa Fe, NM, 12-16 May, 2014).
- Liu, M.. A new polarized solid proton target for Fermilab E1039 Drell-Yan experiment. Invited presentation at Spin2014. (Beijing, China, 20-24 Oct. 2014).
- Prokudin, A.. Transverse Spin Asymmetries and TMD Evolution. Invited presentation at POETIC V. (New Haven, CT, 22-26 Sep. 2014).
- Vitev, I.. Transverse momentum-weighted Siverson asymmetry in semi-inclusive deep inelastic scattering at next-to-leading order. 2014. In QCD Evolution Workshop 2013. (Newport News, 14-17 May 2013). , p. 1460019. New York: International Journal of Modern Physics.
- Vitev, I.. Theoretical Spin Effort at LANL. Invited presentation at E1039 Collaboration Workshop. (Batavia, IL, 18 March, 2014).
- Vitev, I., A. Prokudin, Z. Kang, and L. Dai. Next-to-leading Order Transverse Momentum-weighted Siverson Asymmetry in Semi-inclusive Deep Inelastic Scattering: the Role of the Three-gluon Correlator. *Physical Review D*.
- Vitev, I., Z. Kang, and H. Xing. Transverse Momentum-weighted Siverson Asymmetry in Semi-inclusive Deep Inelastic Scattering at Next-to-leading Order. 2014. *International Journal of Modern Physics Conference Series*. 25: 1460019.
- Walsh, J., I. Snug, G. Sterman, C. Lee, S. Ellis, and L. Almeida. Comparing and counting logs in direct and effective methods of QCD resummation. 2014. *Journal of High Energy Physics*. : 174.

Yoon, B.. Disconnected Contributions to Nucleon Structure.
Invited presentation at Lattice QCD 2014. (Upton, NY,
23-28 Jun. 2014).

Peta-scale Studies of Cosmic Explosions and Supernova Shock Breakout with Palomar Transient Factory

Przemyslaw R. Wozniak
20130030DR

Introduction

The next generation Palomar Transient Factory (PTF-II) is poised to revolutionize the field of time-domain astrophysics with great potential for future discovery, especially in the area of explosive phenomena. This project will conduct the first systematic search for supernova shock breakout events and other explosive transients on time-scales of less than a day. In order to succeed, PTF-II must automatically identify actionable information from the torrent of imaging data, classify emerging events, and optimize the follow-up strategy. To address this challenge, we will develop an autonomous event broker that integrates cutting edge machine learning algorithms with high performance computing infrastructure. Our classification engine will be based on Bayesian belief networks and ensembles of decision trees. Follow-up optimization will employ mutual entropy minimization and dynamic scheduling of available instruments.

A major innovation of PTF-II is Spectral Energy Distribution Machine (SEDM), a low-resolution spectrograph that will enable rapid spectral classification of all interesting transients detected by the photometric pipeline. Our event broker will identify “young” supernovae and enable rapid follow-up observations with high-energy observatories in time to get a glimpse of the shock breakout.

We will also carry out extensive radiation hydrodynamics calculations of transient emission from hot shocks over a wide range of astrophysical scenarios to interpret PTF-II observations, inform transient classifiers, and test the performance of simulation codes in a critically important range of physical conditions. Our goal is to build and publish a suite of ~ 100 explosion models with time-resolved spectra and synthetic light curves at ~ 100 epochs. A detailed comparison of these models with observed light curves will provide valuable constraints on the structure of the supernova progenitor stars and lead to a better understanding of stellar deaths.

Benefit to National Security Missions

This project will build a new astro-informatics competency to address growing national needs in Space Situational Awareness (SSA), develop new capabilities for the Weapons Program, and test them using actual observations. We will combine observation, theory, and computation to explore the physics of cosmic explosions and contribute to a high-impact time-domain sky survey. This project will position us for a future role in the Large Synoptic Survey Telescope (LSST) survey and will open new opportunities for a major involvement in NASA missions and dark energy investigations identified in the strategic plan of the DOE Office of Science. We will develop novel algorithms for classification and tracking of celestial objects relevant to Space Situational Awareness programs aimed at sponsorship by NASA, Department of Defense, and other WFO organizations. Our models of supernova shock breakout and other explosive transients will test Advanced Simulation and Computing (ASC) capabilities in the critically important regime at the transition between diffusion and free streaming using both flux diffusion and implicit Monte Carlo codes. Ultimately, our nuclear nonproliferation efforts depend on satellite assets that are increasingly vulnerable, driving the need for Space Situational Awareness.

Progress

First iteration of Real/Bogus transient classifier for iPTF (version RB3.x) has been completed and deployed at NERSC supercomputing center since July 2013. A new user interface has been created to allow all iPTF collaborators to examine RB3.x scores for candidate transients detected by the imaging pipeline each night. Together with our collaborators at JPL and Caltech we are working to complete and install the second iteration of the algorithm and software this summer. We verified that spectral classification tools for determining the type of supernovae discovered by iPTF are capable of dealing with host galaxy contamination. Preparations are underway to deploy this system when SEDMachine instrument

beginning regular operations this summer.

The software infrastructure for Event Broker has been significantly extended. The system now includes a selection of classification algorithms: Bayesian belief networks, support vector machines, random forest (decision trees), and sparse representations with learned dictionaries. All major components of the Event Broker except follow-up optimization now have working implementations: VOEvent translation of incoming XML messages, context gathering using local and external databases, preliminary event classification, and archiving. The system can now be connected to data streams from RAPTOR instruments and high-energy transient localizations from GCN. With the exception of follow-up optimization to be developed in the third year of the project, we demonstrated an end-to-end flow of events through this distributed system by “replaying” archived imaging data from RAPTOR-P wide field survey. We are currently working on data visualization interface that will be completed by the end of FY14.

Simulation and modeling effort is progressing in parallel. The library of simulated explosions now includes 30 time-evolving models, each characterized with 100 spectra that cover the interesting time interval. The public online database supernova.lanl.gov now includes an interface that allows users to plot light curve predictions for various photometric bands popular among observers. About half of existing models are already available for viewing using this new interface. An important milestone was the study of the effects of the thickness of the hydrogen envelope on supernova shock breakout and light curves that can be observed by the Swift satellite. The results were presented at the workshop “Transient Universe as Seen by iPTF and ZTF” in Stockholm, Sweden, and submitted for publication in *The Astrophysical Journal*. Several papers have been published on explosions of some of the first stars to form in the Universe and transients caused by pair instability. Another study that resulted in three papers (2 published and 1 submitted) showed that bright optical transients associated with gamma-ray bursts may originate from synchrotron inverse-Compton emission from electron positron pairs and self-absorption effects at very high energies (GeV).

The work on data intensive computing led to the development of a new distributed database architecture and working prototype for time-resolved photometric measurements from massive sky monitoring surveys. The data is partitioned according to the Quad Tree Cube (Q3C) indexing scheme that allows rapid storage and retrieval of measurements covering a random patch of sky. Physical storage is then mapped to a set of PostgreSQL database servers, each holding a fixed set of Q3C cells. The cells have fuzzy

edges, i.e. measurements near their edges are replicated in neighboring cells, so that the data can be clustered and queried locally, without crossing server boundaries. This allows a linear scaling for the most time consuming data manipulation tasks. We also invented a progressive hierarchical clustering algorithm for building long photometric time histories that does not require issuing unique object ids or frequent updates. This eliminates a very constraining performance bottleneck and the need for cumbersome book keeping. These results were presented at the Databases in Networked Information Systems 2014 workshop in Aizu, Japan.

Future Work

In FY15 we will implement the third and final iteration of the Real/Bogus transient classifier (RB3.x) and train the algorithm on updated training data. We will also complete our spectral supernova classifier and begin processing data from the new SEDMachine spectrograph. The architecture and software infrastructure of the event broker will be further extended and tested on real data. The main focus of this thrust will be the development of automated follow-up optimization algorithms for the event broker and implementing a follow-up marshal. After we finish the data visualization portal, we will demonstrate a complete end-to-end flow of transient alerts through this distributed system. Initially we plan to connect live data streams from the next generation RAPTOR-P telescope array and high-energy transient localizations from GCN. The next step will be to exchange transient localizations between RAPTOR and iPTF and trigger follow-up observations based on inferences made by our event broker.

The simulation and modeling work will focus on building the final set of 100 models of explosive astrophysical transients and making the entire library of models available for viewing in supernova.lanl.gov database. Our science goals are to study dependence of explosion phenomenology on progenitor parameters such as mass and the amount of mixing in the stellar interior, and to model interesting iPTF events. The graphical interface will be extended to include plotting of multi-color light curves using filter sets for major photometric sky surveys and overplotting real measurements uploaded by users. A stretch goal is to include simple matching of models to a user-supplied set of measurements.

Data intensive computing work will proceed in parallel. We will run performance tests on the new photometric database based on Q3C indexing/partitioning and demonstrate the scalability of this approach on a data intensive computing and storage cluster.

Conclusion

Time-domain astrophysics and the science of cosmic explosions are at the forefront of modern astrophysics. The Palomar Transient Factory (PTF) has emerged as the world leader in the exploration of cosmic explosions and the most successful precursor to multi-petabyte sky surveys of the future such as the Large Synoptic Survey Telescope (LSST). The main goal of this project is to develop information technology and data intensive computing infrastructure for the next generation PTF and open the domain of short time-scales (less than 1 day) for exploration by deep wide-area surveys.

Publications

- Barth, A. J., A. Voevodkin, D. J. Carson, and P. Wozniak. A Search for Optical Variability of Type 2 Quasars in SDSS Stripe 82. 2014. *The Astronomical Journal*. 147 (1): 12.
- Bayless, A. J., T. A. Pritchard, P. W. A. Roming, P. Kuin, P. J. Brown, M. T. Botticella, M. Dall’Ora, L. H. Frey, W. Even, C. L. Fryer, J. R. Maund, and M. Fraser. The Long-lived UV “Plateau” of SN 2012aw. 2013. *The Astrophysical Journal*. 764: L13.
- Bayless, A. J., W. Even, L. H. Frey, C. L. Fryer, P. W. A. Roming, and P. A. Young. The Effects on Supernova Shock Breakout and Swift Light Curves Due to the Mass of the Hydrogen-Rich Envelope. *The Astrophysical Journal*.
- Bellm, E. C., N. M. Barriere, Bhalerao, S. E. Boggs, S. B. Cenko, F. E. Christensen, W. W. Craig, Forster, C. L. Fryer, C. J. Hailey, F. A. Harrison, Horesh, Kouveliotou, K. K. Madsen, J. M. Miller, E. O. Ofek, D. A. Perley, V. R. Rana, S. P. Reynolds, Stern, J. A. Tomsick, and W. Zhang. X-RAY SPECTRAL COMPONENTS OBSERVED IN THE AFTERGLOW OF GRB 130925A. 2014. *ASTROPHYSICAL JOURNAL LETTERS*. 784 (2).
- Cao, Y., S. R. Kulkarni, S. Valenti, D. A. Howell, I. Arcavi, J. Johansson, R. Amanullah, A. Goobar, J. Sollerman, F. Taddia, A. Gal-Yam, A. Horesh, I. Sagiv, S. B. Cenko, M. M. Kasliwal, P. E. Nugent, J. Surace, P. R. Wozniak, D. I. Moody, U. D. Rebbapragada, and B. D. Bue. Ultraviolet Radiation from Supernova-Companion Collision in a Type Ia Supernova. *Nature*.
- Frey, L. H., W. Even, D. J. Whalen, C. L. Fryer, A. L. Hungerford, and C. J. Fontes. The Los Alamos Supernova Light-curve Project: Computational Methods. 2014. *The Astrophysical Journal Supplement*. 204: 16.
- Frey, L., C. Fryer, and P. Young. Can Stellar Mixing Explain the Lack of Type Ib Supernovae in Long-duration Gamma-Ray Bursts?. 2013. *The Astrophysical Journal Letters*. 773: L7.
- Fryer, C.. Compact Object Formation and the Supernova Explosion Engine. 2013. *Classical and Quantum Gravity*. 30 (24): 244002.
- Fryer, C. L., W. Even, B. W. Grefenstette, and T. W. Wong. Observational constraints of stellar collapse: Diagnostic probes of nature’s extreme matter experiment. 2014. *AIP Advances*. 4 (4): 041014.
- Hsiao, E. Y., M. A. Nyothers, P. W. Wozniak, and O. Yaron. Strong near-infrared carbon in the Type Ia supernova iPTF13ebh. *Astronomy and Astrophysics*.
- Jin, Z. P., S. Covino, M. Della Valle, P. Ferrero, D. Fugazza, D. Malesani, A. Melandri, E. Pian, R. Salvaterra, D. Bersier, S. Campana, Z. Cano, A. J. Castro-Tirado, P. D’Avanzo, J. P. U. Fynbo, A. Gomboc, J. Gorosabel, C. Guidorzi, J. B. Haislip, J. Hjorth, S. Kobayashi, A. P. LaCluyze, G. Marconi, P. A. Mazzali, C. G. Mundell, S. Piranomonte, D. E. Reichart, R. Sanchez-Ramirez, R. J. Smith, I. A. Steele, G. Tagliaferri, N. R. Tanvir, S. Valenti, S. D. Vergani, T. Vestrand, E. S. Walker, and P. Wozniak. GRB 081007 and GRB 090424: The Surrounding Medium, Outflows, and Supernovae. 2013. *The Astrophysical Journal*. 774: 114.
- Johnson, J., D. Whalen, W. Even, C. Fryer, A. Heger, J. Smidt, and K. J. Chen. The Biggest Explosions in the Universe. 2013. *The Astrophysical Journal*. 775: 107.
- Ofek, E., A. Zoglauer, S. Boggs, N. Barriere, S. Reynolds, C. Fryer, F. Harrison, S. Cenko, S. Kulkarni, A. Gal-Yam, I. Arcavi, E. Bellm, J. Bloom, F. Christensen, W. Craig, W. Even, A. Filippenko, B. Grefenstette, C. Hailey, R. Laher, K. Madsen, E. Nakar, P. Nugent, D. Stern, M. Sullivan, J. Surace, and W. Zhang. SN 2010jl: Optical to hard X-ray observations reveal an explosion embedded in a ten solar mass cocoon. 2014. *The Astrophysical Journal*. 781 (1): 420.
- Palaversa, L., Z. Ivezic, L. Eyer, D. Ruzdjak, D. Sudar, M. Galin, A. Krofflin, M. Mesaric, P. Munk, D. Vrbanc, H. Bozic, S. Loebman, B. Sesar, L. Rimoldini, N. Hunt-Walker, J. VanderPlas, D. Westman, S. J. Stuart, A. Becker, G. Srdoc, P. Wozniak, and H. Olusei. Exploring the Variable Sky with LINEAR. III. Classification of Periodic Light Curves. 2013. *The Astronomical Journal*. 146: 101.
- Panaitescu, A., W. T. Vestrand, and P. Woźniak. “Self-absorbed” GeV Light Curves of Gamma-Ray Burst Afterglows. 2014. *apj*. 788: 70.
- Panaitescu, A., W. T. Vestrand, and P. Woźniak. Peaks of optical and X-ray afterglow light curves. 2013. *mnras*. 433: 759.
- Panaitescu, A., and T. Vestrand. Synchrotron and Inverse-Compton Emissions from Pairs Formed in GRB Afterglows (Analytical Treatment). 2014. *The*

- Astrophysical Journal. 793: 104.
- Sesar, B., Z. Ivezić, S. J. Stuart, D. M. Morgan, A. Becker, S. Sharma, L. Palaversa, M. Juric, P. Wozniak, and H. Olusei. Exploring the Variable Sky with LINEAR. II. Halo Structure and Substructure Traced by RR Lyrae Stars to 30 kpc. 2013. The Astronomical Journal. 146: 21.
- Skillman, S. W., M. S. Warren, M. J. Turk, R. H. Wechsler, D. E. Holz, and P. M. Sutter. Dark Sky Simulations: Early Data Release. The Astrophysical Journal.
- Smidt, J., D. J. Whalen, E. Chatzopoulos, B. K. Wiggins, K. J. Chen, A. Kozyreva, and W. Even. Finding the First Cosmic Explosions. IV. 90 - 140 M_{\odot} Pair-Instability Supernovae. The Astrophysical Journal.
- Smidt, J., D. J. Whalen, W. Even, B. Wiggins, J. L. Johnson, and C. L. Fryer. Population III Hypernovae. 2014. The Astrophysical Journal. 797: 97.
- Vreeswijk, P., A. Raassen, A. Smette, A. De Cia, P. Wozniak, A. Fox, W. Vestrand, and P. Jakobsson. Time-dependent excitation and ionization modelling of absorption-line variability due to GRB 080310. 2013. Astronomy and Astrophysics. 549: A22.
- Whalen, D. J., J. Smidt, W. Even, S. E. Woosley, A. Heger, M. Stiavelli, and C. L. Fryer. Finding the First Cosmic Explosions. III. Pulsational Pair-instability Supernovae. 2014. *apj*. 781: 106.
- Whalen, D. J., W. Even, J. Smidt, A. Heger, K. J. Chen, C. L. Fryer, M. Stiavelli, H. Xu, and C. C. Joggerst. Supermassive Population III Supernovae and the Birth of the First Quasars. 2013. *apj*. 778: 17.
- Whalen, D. J., W. Even, J. Smidt, A. Heger, R. Hirschi, N. Yusof, M. Stiavelli, C. L. Fryer, K. J. Chen, and C. C. Joggerst. Pair-Instability Supernovae in the Local Universe. 2014. The Astrophysical Journal. 797: 9.
- Whalen, D. J., W. Even, L. H. Frey, J. Smidt, J. L. Johnson, C. C. Lovekin, C. L. Fryer, M. Stiavelli, D. E. Holz, A. Heger, S. E. Woosley, and A. L. Hungerford. Finding the First Cosmic Explosions. I. Pair-instability Supernovae. 2013. *apj*. 777: 110.
- Whalen, D., J. Johnson, J. Smidt, A. Heger, W. Even, and C. Fryer. The Biggest Explosions in the Universe. II. 2013. The Astrophysical Journal. 777 (2): 99.
- Whalen, D., J. Johnson, J. Smidt, A. Meiksin, A. Heger, W. Even, and C. Fryer. The Supernova that Destroyed a Protogalaxy: Prompt Chemical Enrichment and Supermassive Black Hole Growth. 2013. The Astrophysical Journal. 774: 64.
- Whalen, D., W. Even, C. Lovekin, C. Fryer, M. Stiavelli, P. Roming, J. Cooke, T. Pritchard, D. Holz, and C. Knight. Illuminating the Primeval Universe with Type II_n Supernovae. 2013. The Astrophysical Journal. 768: 195.
- Wozniak, P. R., D. I. Moody, Z. Ji, S. P. Brumby, H. Brink, J. Richards, and J. S. Bloom. Automated Variability Selection in Time-domain Imaging Surveys Using Sparse Representations with Learned Dictionaries. 2013. In American Astronomical Society, AAS Meeting #221. (Long Beach, CA, 6-10 January 2013). , p. #431.05. Washington, DC: American Astronomical Society.

Nuclear and Particle Futures

Directed Research
Continuing Project

Probing New Sources of Time-Reversal Violation with Neutron EDM

Takeyasu Ito
20140015DR

Introduction

An electric dipole moment (EDM) measures the separation of positive and negative charges within a system and is an extremely sensitive probe of physics beyond the standard model, the accepted theory of elementary particles. The neutron EDM (nEDM) is said to have “killed more theories than any other single measurement.”

This LDRD project is a joint experimental and theoretical project to probe new sources of time reversal violation (T violation) with the nEDM. Using the LANSCE (Los Alamos Neutron Science Center) Ultracold Neutron (UCN) source, we will develop a new nEDM experiment with a sensitivity goal of 3×10^{-27} e-cm, a 10-fold improvement over the current limit. More specifically, we will upgrade the existing UCN source which is expected to result in a 10-fold performance increase. In addition, we will build a prototype nEDM experimental apparatus. With the upgraded UCN source and prototype nEDM apparatus, we will demonstrate that it is possible to perform an nEDM experiment with a sensitivity of 3×10^{-27} e-cm. Note that the UCN density is the key parameter that is necessary for reaching the sensitivity goal.

At the same time, to match the anticipated experimental improvement, we will perform a comprehensive model-independent analysis of T violation beyond the standard model (BSM) and we will pioneer first-principles calculations of the matrix elements, essential in extracting and bounding the underlying BSM sources of T violation from EDM measurements.

The goal of this LDRD project is to reduce the technical risk of a full-fledged nEDM experiment at LANL with sensitivity of 3×10^{-27} e-cm.

Benefit to National Security Missions

The proposed research is central to both the LANL (Los Alamos National Laboratory) nuclear physics program and the future of the US (United States) program on

fundamental symmetries in nuclear science. The proposed upgrade of the UCN (Ultracold Neutron) source is in line with the 2010 LANL NPAC (Nuclear, Particle, Cosmology, and Astrophysics) strategic plan that recommended development of a medium scale facility, and will benefit other experiments such as a neutron lifetime experiment, which received a strong community endorsement in a recent international workshop. Furthermore, completion of the proposed experimental tasks will provide a viable alternate approach to the high-risk SNS (Spallation Neutron Source) nEDM (neutron electric dipole moment) experiment, which has a large P division involvement. This will also lead to project funds coming to LANL if a decision is made to go forward with this new nEDM experiment.

In addition, this project will strengthen an already existing successful synergy of theory and experiment in fundamental neutron physics. This is a unique strength of LANL across US laboratories. This LDRD (Laboratory Directed Research and Development) will establish LANL T-division as one of the main US centers for nucleon matrix elements computations with lattice QCD (Quantum Chromodynamics). This will put a solid basis to seek additional external funding, through the channels of DOE (Department of Energy) Nuclear Theory topical collaboration centers as well as SciDAC grants in both High Energy and Nuclear Physics.

Additionally, the UCN source improvement will benefit fundamental neutron physics experiments, actinide sciences, and detection technology.

Progress

Experimental Work

UCN source upgrade: We have modeled the new ultracold neutron (UCN) source using MCNP6. Our focus was to optimize the geometry of the source as well as the material for the cold neutron moderator. First various necessary scattering kernels for MCNP were obtained,

including solid deuterium, cold polyethylene, solid methane, and mesitylene. Then we varied various parameters of the source geometry, including the diameter and height of the solid deuterium volume as well as the thickness of the cold neutron moderator, for each of the cold neutron moderator materials. Our near-final conclusion is that liquid methane or warm solid methane is the ideal cold neutron moderator for this purpose. This is because the ultra cold neutron production cross section in solid deuterium has a peak at 6 meV, which corresponds to a temperature of 70 K, and also solid deuterium itself has an effect of cooling the cold neutron flux. At the same time, engineering design for the new UCN source progressed. The internal valve design was complete. The engineering design for the main cryostat is near completion. It is waiting for the final conclusion of the MCNP simulation as well as information on the possible beam heating.

UCN guide components: We have finished setting up for the test of the superconducting magnet, which will be used as the spin polarizer for the UCN. A preliminary guide layout was completed. A detailed study is being conducted using a monte carlo simulation study.

nEDM prototype apparatus: A preliminary design for the ^{199}Hg comagnetometer test system is complete. We are currently in the process of procurement of the necessary laser system. Also a preliminary design of the HV test apparatus is complete. A final engineering design is under way. At the same time, we are in the process of procuring the necessary HV power supply.

Theoretical Work

Formulation of the problem: We have identified the leading sources of BSM T-violation in two operators, namely the quark electric dipole moment (qEDM) and the quark chromo-electric dipole moment (CEDM). When considered at the quantum level, the matrix elements of these operators are divergent and need subtractions, that usually mix the operators under study with others and require the

Extension of the operator basis: The definition of finite operators requires computing a so-called matrix of renormalization constants. We have a) identified the basis of operators that mix with qEDM and CEDM; b) identified and computed in perturbation theory the set of matrix elements (with quark and gluon external state) that allow us to determine all the renormalization constants; c) we have obtained results on the matrix of renormalization constants in the so-called minimal subtraction scheme. We will next obtain renormalization constant in a non-perturbative scheme suitable for lattice QCD (Quantum Chromo Dynamics), as outlined in the proposal. The results of our analysis will be presented at the Lattice 2014 conference

and will result in a publication in a 2-3 months time scale.

Computation of the neutron electric dipole moment induced by the cEDM operator: We have realized that the cEDM operator is renormalized multiplicatively and that its matrix elements are related to the so-called tensor charge of the nucleon. We have preliminary results for the so-called isoscalar (equal couplings to up and down quarks) and isovector (opposite couplings to up and down quarks) tensor charges. These new results involve the challenging calculation of the so-called disconnected diagrams. We are currently studying the systematic effects due to finite volume and finite lattice spacing. We expect this analysis to lead to the first lattice QCD results of qEDM-induced neutron and proton EDMs. We plan to submit a paper with these results later this year.

Future Work

In FY15, the main focus of the experimental part will be to construct and test the new ultra cold neutron source, based on the simulation and engineering design work performed in FY14. The work involved include: 1) construction and testing of the cryostat, 2) construction of the UCN guide and testing them using ultra cold neutrons, 3) removing the current source and replacing it with the new UCN source, and 4) commissioning the new UCN source. In addition, we will characterize the current source performance using the nEDM chamber constructed by the Technical University of Munich group. Also we will perform tests using the small high voltage test apparatus and will also construct the ^{199}Hg homagnetometer.

The theory effort will focus on three topics in FY15. (i) They will complete the 1-loop calculation of the mixing and renormalization of the two leading [quark EDM and chromo EDM] novel CP violating operators. These calculations are needed to connect CP violation at TeV scale to the effective theory used to analyze nEDM at the hadronic scale of a few GeV. (ii) Carry out first simulations of the quark EDM operator including both connected and disconnected Feynman diagrams and report these results in a publication. (iii) Develop numerical techniques for calculating the matrix elements of the chromo EDM operator using lattice QCD and test and compare the statistical signal in numerical simulations.

Conclusion

By the end of the three-year period, we expect to achieve the following:

- Improved UCN source that increases flux by 20-fold
- Demonstration of the feasibility of an nEDM experiment with a sensitivity of 3×10^{-27} e-cm, through dem-

onstration of the necessary UCN density stored in the prototype nEDM chamber

- First-principles calculation based determination of the relevant matrix elements, essential in extracting and bounding the underlying BSM sources of T violation from EDM measurements

Publications

Bhattacharya, T., V. Cirigliano, and R. Gupta. Neutron Electric Dipole Moments from Beyond the Standard Model Physics . 2014. In 31st International Symposium on Lattice Field Theory (Lattice 2013). (Mainz, Germany, July 29- Aug 3 2013). , p. 299. Trieste, Italy: PoS LATTICE2013 .

Ito, T.. Science program at lanl ucn source. Invited presentation at The 2nd International Symposium on Science at J-PARC (J-PARC 2014). (Tsukuba, 12-15 Jul. 2014).

Nuclear and Particle Futures

Directed Research
Continuing Project

First Direct Measurement of High-Z/Low-Z Plasma Interface Evolution in Isochorically Heated Dense Plasma (U)

Brian J. Albright
20140029DR

Introduction

This research project seeks to use unique capabilities of the LANL Trident laser system to resolve long-standing questions in our understanding of mix in plasma: how do material interfaces evolve in plasma? What roles do electrostatic fields play in mix? What is the final state of the material? This problem is of critical importance to a wide range of settings, including astrophysics, fusion energy, and defense applications.

One of the reasons this problem is so hard is that making dense plasma requires enormous facilities, such as the National Ignition Facility at LLNL or the Z Machine at Sandia National Laboratory; in such, the time scale over which plasma is assembled, tens of billionths of a second, is the same as that over which the plasma expands or “disassembles.” Consequently, it’s very hard to make plasma that is uniform to do a controlled experiment. Instead, experiments have large variations in temperature and density, making whatever results one obtains ambiguous (at best) and often impossible.

Our project is different. We will use ion beams made from the ultra-intense, short-pulse Trident laser to heat our solid-density targets “isochorically,” or much faster than the disassembly time. This means that we can make highly uniform dense plasma for which we can measure the plasma conditions to unprecedented precision, something that’s never been done before. We can then measure the evolution of plasma interfaces using a series of x-ray snapshots.

Together with an integrated theory and modeling effort using ASC multiphysics codes and the world-leading VPIC kinetic plasma code, we seek to profoundly advance the state of art in mix research. While this project is of high risk, the potential for fundamental changes to how we approach this important problem is now within our grasp.

Benefit to National Security Missions

Our goal is to answer fundamental, long-standing questions in the understanding of mix in plasma.

Mix is central to the DOE/NNSA Defense Programs mission. Mix models are vital components of multiphysics codes, used for a range of applications, including, importantly, assessing the safety, security, and reliability of the stockpile. Our experiments will enable validation of key components of these models.

Mix is also believed to be one of the major issues underpinning success of the NNSA thrust in inertial confinement fusion. Successful demonstration of inertial confinement fusion also directly impacts the DOE Office of Fusion Energy Science efforts in inertial fusion energy, a nuclear energy option.

The experiment we proposed was a pilot “First Experiment” envisioned for the High Intensity Laser Laboratory (HILL). HILL was proposed in response to the recent NNSA call as one of the LANL signature facility options and was documented in the Tri-Lab Facility Roadmap; the facility remains a credible upgrade path for MaRIE 1.0 and, in fact, was within the original scope of MaRIE before budgetary pressures mandated its removal from the MaRIE 1.0 scope. Success of our project will inform the eventual scope of MaRIE and may, in fact, impact the establishment of mission need outlined in the CD0 call. HILL was also one of the proposed DOE Office of Science signature class facilities in a recent call.

Laser-ion beam generation has other applications: non-proliferation and active interrogation, medical hadron-therapy, and material damage studies important for advanced materials, nuclear energy, and space applications.

Progress

We have performed several tasks in past 12 months, in-

volving theory, modeling, experiments, target fabrication, and diagnostics development:

We successfully designed and fielded in May/June 2014 an experimental campaign on Trident to characterize ion beam generation, to prove that the use of a second “blocker foil” to block the laser interaction with our multi-component plasma, to characterize the isochoric heating of targets using a novel optical streak diagnostic (never before fielded in the short pulse environment), and to make initial gated x-ray imaging measurements of the evolution of interfaces in multi-component targets. While laser problems prevented us from accomplishing all that we had set out to do in this campaign, we nevertheless succeeded and validated our radhydro modeling of the target conditions after heating and validated our stopping model estimates of energy deposition in dense plasma. To the best of our knowledge, this is the first time anyone has used such laser-generated ion beams to isochorically and uniformly heat solid density targets to the plasma phase.

Experiments were performed on a variety of non-cryogenic targets to refine our diagnostics capability and to give us preliminary experimental results to compare to our theoretical models. These included diamond and gold foil targets. Detailed comparisons were performed with SESAME equations of state and modeling using both an ASC and a legacy radhydro code, as well as stopping estimates using the SRIM code.

University collaborators are engaged, we have a MOU and contract in place, and we are beginning to work on production of the UV pyrometer diagnostic, capable of measuring the evolving plasma temperature in our experiments.

We performed a feasibility study of the use of proton-radiography to do deflectometry (i.e., using the deflections of proton beams as a probe for electrostatic fields) and have determined that this is not a viable technology option for our experiments. Consequently, we are exploring other possible options (e.g., doping the material at the interface with a high-Z tracer and using Stark broadening of spectral lines) to measure these fields directly.

A comprehensive set of radhydro design simulations were performed to refine our ion beam requirements and inform our experimental design for the May/June and future campaigns. These simulations (and synthetic radiographs made from same) proved invaluable in interpreting our diagnostics.

An in-depth study was made of the tradeoffs of using different laser-generated ion beams, including both SRIM modeling of energy deposition and uniformity, as well as

extensive particle-in-cell modeling of the laser-ion sources. Based on these studies, we down-selected to aluminum ions (an article on the ion source is under review with Nature; also, a follow-on PRL on the source is in preparation).

We gave the following invited talks:

J. C. Fernandez, “Laser-driven ion acceleration advances,” 2nd International Conference on High Energy Density Physics (ICHEDP) in Beijing, September 21 – 25, 2014

B. J. Albright, “Use of Laser-Generated Ion Beams for Isochoric Heating to Study Plasma-Phase Mix at Heterogeneous Interfaces”, 16th Advanced Accelerator Concepts Workshop in San Jose, 14-18 July, 2014

S. Palaniyappan, “Magnetic electron trapping generates efficient quasi-monoenergetic ion beam from laser-driven plasmas” 16th Advanced Accelerator Concepts Workshop in San Jose, 14-18, July, 2014

We briefed the LANL ASC Thermonuclear Burn Initiative project on laser isochoric heating and plasma phase mix

Future Work

The following are our tasks and goals for the next FY:

- Perform two experimental campaigns on TRIDENT to measure and study plasma-phase mix evolution.
- Work with our university colleagues to field for the first time cryo (solid hydrogen) targets on TRIDENT.
- Analyze our GXI data from the May/June campaign and refine the GXI diagnostic for our next campaign this Fall, to ensure proper timing, avoidance of misfires, and that alignment issues do not present a problem (as they did in the May/June 2014 campaign).
- Engage our university collaborators on the development of the UV pyrometer diagnostic to make independent measurements of target temperature. (This work was delayed somewhat by difficulties in getting the contract in place and in funding shortfalls in FY14).
- Perform extensive radhydro modeling of our composite targets, using what we’ve learned from this past campaign about the ion heating modality.
- Design and seek to field an complementary, alternative, composite target concept of interest to the LANL Science Campaigns
- Refine our theory and modeling of plasma interface dynamics to take into account recent developments in this field in other areas of the Laboratory.

- Perform kinetic simulations of the two-foil laser-ion source to optimize positioning of the second foil for enhanced ion flux and better heating

Conclusion

We will measure for the first time the rate of interface evolution in dense plasma, something that has never been done before. We will use these data to validate our theoretical models of plasma mix and to highlight possible new research directions to improve our ability to predict how mix evolves in dense plasma.

This experiment is a prototype for an entirely new class of isochoric heating experiments driven by ultra-intense, short-pulse lasers. It represents a new capability for the Laboratory giving us tools to answer a wide range of questions in high energy density physics.

Publications

Albright, B. J.. Use of laser-generated ion beams for isochoric heating to study plasma-phase mix at heterogeneous interfaces. Invited presentation at 16th Advanced Accelerator Concepts Workshop (AAC 2014). (San Jose, California, 13-18 July, 2014).

Fernández, J. C.. High power density ion beams driven by lasers: progress and applications. Invited presentation at 2nd International Conference on High Energy Density Physics. (Beijing, China, 21-24 Sept. 2014).

Fernández, J. C., B. J. Albright, F. N. Beg, M. E. Foord, B. M. Hegelich, J. J. Honrubia, M. Roth, R. B. Stephens, and L. Yin. Fast ignition with laser-driven proton and ion beams. 2014. *Nuclear Fusion*. 54 (5): 054006.

Hegelich, B. M., D. Jung, L. Yin, B. J. Albright, D. C. Gautier, S. Palaniyappan, R. Shah, B. Dromey, M. Yeung, C. Hamilton, S. Letzring, R. Munchhausen, H. C. Wu, and J. C. Fernández. 160 MeV laser-accelerated protons from CH₂ nano-targets. *Physical Review Letters*.

Hegelich, B. M., D. Jung, and L. Yin. Recent achievements on ion acceleration. Invited presentation at 41st European Physical Society Conference. (Berlin, Germany, 23-27 June, 2014).

Jung, D., B. J. Albright, L. Yin, D. C. Gautier, B. Dromey, R. Shah, S. Palaniyappan, S. Letzring, H. C. Wu, T. Shimada, R. P. Johnson, D. Habs, M. Roth, J. C. Fernández, and B. M. Hegelich. Scaling of ion energies in the relativistic induced transparency regime. *New Journal of Physics*.

Jung, D., B. J. Albright, L. Yin, D. C. Gautier, R. Shah, S. Palaniyappan, S. Letzring, B. Dromey, H. C. Wu, T.

Shimada, R. P. Johnson, M. Roth, J. C. Fernández, D. Habs, and B. M. Hegelich. Beam profiles of proton and carbon ions in the relativistic transparency regime. 2013. *New Journal of Physics*. 15 (12): 123035.

Palaniyappan, S.. Magnetic electron trapping generates efficient quasi-monoenergetic ion beam from laser-driven plasma. Invited presentation at 16th Advanced Accelerator Concepts Workshop (AAC 2014) . (San Jose, California, 13-18 July, 2014).

Palaniyappan, S., D. C. Gautier, C. K. Huang, C. E. Hamilton, J. A. Cobble, C. Kreuzer, J. C. Fernández, and R. Shah. Efficient quasi-monoenergetic ion beam from laser-driven plasmas. *Nature*.

Nuclear and Particle Futures

Directed Research
Continuing Project

The Role of Short-lived Actinide Isomers in High Fluence Environments (U)

Marian Jandel
20140046DR

Introduction

In this project we will determine the nuclear physics properties of the actinide isomers, namely ^{236}U and ^{239}U , and quantify their role in explosive environments. Apart from the knowledge of their existence and half-lives, there are no available data on the quantitative population of these short-lived actinides isomeric states following neutron capture. Our preliminary experimental studies at LANSCE suggest there may be substantial population of high energy isomeric states in the neutron capture process on actinides. These new, unanticipated results may have significant implications on our understanding of nuclear reaction networks in high neutron fluence environments such as those occurring in nuclear explosions. New experiments will be staged and performed at LANSCE at the Detector for Advanced Neutron Capture Experiments facility (DANCE), that will provide new information about neutron-induced reactions on fissile actinides. With improved experimental capabilities, we will obtain new precision data on yields of isomers after neutron capture on ^{235}U and information on prompt fission neutrons and gamma rays. Experimental and theoretical work on reaction rates leading to (and on) isomeric states is very complex and represents a high risk part of this proposal. Low risk objectives include neutron-induced fission studies, which must be performed very accurately in order to address the process of neutron capture in detail. Experimental work will include developments of a compact 4pi neutron detector array that will be installed in the central cavity of the DANCE detector array to detect prompt fission neutrons – NEUANCE (the NEUtron detector at dANCE). On the theoretical front we will develop models for calculation of neutron-induced reactions on excited states, neutron transport codes to populate excited isomeric states in actinides, and nuclear de-excitation models to interpret isomeric yields, and fission fragment de-excitation including prompt fission n-gamma-fission fragment correlations.

Benefit to National Security Missions

Recent and urgent interest of various governmental agencies, such as the Office of Non-Proliferation Research and Development (NNSA NA-22), in more precise and correlated data on neutron-induced reactions will put the capabilities developed during this project into a great position to support mission needs for systematic measurements of isomeric state production in neutron capture, correlated induced-fission data, predictive modeling of capture and fission and refinement of transport codes such as MCNP to include important details on correlated radiation from neutron-induced reactions. New signatures for special material detection, nuclear proliferation and forensics will be the objectives of the follow up research, which is a core mission of this laboratory. Knowledge of the production and de-excitation properties of actinide isomers will provide constraints on our understanding of the performance of our well characterized US nuclear tests. Of equal importance it will provide insights to global security missions associated with nuclear forensics efforts where the ingoing properties of devices will be unknown and actinide observables such as ^{237}U , ^{240}U , are what will be available to diagnose the device characteristics. It is important that we understand how actinide isomeric population can influence the production of the actinide observables.

Progress

For the NEUANCE detector development, we procured three test scintillators made of different materials - EJ-309 (a standard liquid scintillator), EJ-325 (a mineral-oil-based scintillator) and stilbene (a solid organic compound) and tested them with photomultiplier tube readout and transient-digitizer data acquisition system similar to the final acquisition system. Tests with radioactive sources showed that high light output was required for good pulse-shape discrimination. The stilbene and EJ-309 detectors were tested for their ability to measure fission neutrons using a ^{235}U fission chamber in the neutron beam at the Lujan Center. Fission neutrons from

the low-energy fission resonances were clearly observed with very little background, verifying that the detectors will successfully operate in an ambient low-energy neutron background. The EJ-309 currently appears adequate for our application. Additional tests with radioactive sources and “silicon photomultiplier” readout are underway. The “silicon photo-multipliers” are small chip-based sensors which will be ideal for the NEUANCE readout, but further development is needed for them to perform as well as the (much larger) photomultiplier tube readout.

An initial prototype symmetric design of NEUANCE has been completed and an order has been placed for 1 quadrant of the detector in order to test the design performance. A segment of an alternate simple, asymmetric design has also been ordered to compare performance of the two. A prototype of the detector will be produced in a few weeks to test the efficiency and the performance of a such novel detector. All parts needed for the prototype has been ordered and received.

We designed a neutron source that provides a timing signal. A prototype of the source has been produced using a small amount of Cf-252 with alpha activity of 100 Bq. The source is sealed. The timing signal is given by detecting the two fission fragments with plastic scintillator foils. Currently we are testing the performance of this prototype neutron source.

We have improved our theoretical simulations of the properties of prompt gamma rays by adding a time coincidence window in which we take into account the decay of long-lived (compared to the measurement time) isomeric states in fission fragments. Some of the discrete gamma lines associated with the decay of those states disappear from the total gamma-ray spectrum for very short time coincidence windows. An improvement in the average total gamma-ray spectrum is also observed. We have prepared several large-scale simulations for the future use in the transport codes to simulate the NEUANCE detector. The capture gamma-ray cascade simulation was extended, so that a few strong discrete states, which are embedded in the continuum region, are allowed. These states produce strong discrete gamma-ray lines that were impossible with our old version. The effect of Porter-Thomas distribution of the gamma-decay width is also studied.

We tested waveform digitizer modules under a variety of conditions, both with beam at DANCE and with sources. These tests demonstrated the viability of CAEN VX1730B digitizers to meet our DAQ needs. The digitizers have been purchased. Uncertainty in the LDRD program budget delayed our original delivery date from July to September. The test period also guided the software development

path for the new DAQ and identified specific steps that need to be taken for it to become operational. The development process is on track to meet our objective of adopting the new system for production in FY2015.

The GEANT4 simulation has been developed to include two possible geometrical configurations of liquid scintillator, each with variable dimensions and degrees of segmentation. This functionality allows us to estimate the efficiency of neutron detection, signal pileup, and the attenuation of gamma-rays for different design configurations. Results from CGMF have also been integrated as input for the simulation. Cascades produced by the CGMF code are fed into GEANT4, passing along primary event information such as neutron and gamma-ray energies, multiplicities, and emission angles. The modules that can simulate the scintillation light response (such as pulse shape and detection efficiency etc.) are under development. A planned removal of LiH shell, currently installed in the center of the DANCE array, will introduce scattered neutron backgrounds. In order to mitigate these backgrounds, we are designing new shielding options using Li and/or Boron loaded polyethylene.

Future Work

NEUANCE detector development

NEUANCE will be built and first tests will be performed with the Cf-252 spontaneous fission source. The NEUANCE will be installed in the center of the DANCE detectors array by the end of next beam cycle at LANSCE - currently scheduled for January 2015.

Development of multi-actinide foil detectors of fission fragments

During the first year, we found another alternative to MP-PAC detector which will use thin scintillator films to detect fission fragments. This development will continue parallel to MPPAC development and based on the performance, this technology may possibly replace MPPAC.

Test/develop new DAQ using VME CAEN digitizers

New digitizers will arrive in early Sep 2014. The implementation of the new DAQ will start in parallel with the old DAQ, without effecting standard measurement campaigns at DANCE facility. The goal is to adopt and benchmark DAQ by the end of next fiscal year (FY15). We will also incorporate the high resolution HPGe detectors in the DANCE DAQ.

Theoretical work to include the following:

- CGMF - gamma-ray de-excitation model development using preliminary U236* data
- CGMF - fission event generator for NEUANCE design and optimization
- Excited states calculations for U236*

-
- Sensitivity studies in transport simulations including delayed gamma-ray emission

Conclusion

New data on isomer production after neutron capture will help benchmark the theory of compound nucleus de-excitation and theory of the cross section on excited states. New capability will be created after completion of this project that will enable measurements of correlated data on fission relevant to applications of National Security, Nuclear Forensics and Energy.

Publications

- al, I. Stetcu et. Properties of prompt-fission gamma rays. 2014. Phys Rev C. 90: 024617.
- al, M. Jandel et. Current and Future Research at DANCE. European Journal of Physics Proceedings.
- al, S. Mosby et. A fission fragment detector for correlated fission output studies. Nuclear Instruments and Methods A. 757: 75.
- al., A. Couture et. Enhancing the Detector for Advanced neutron Capture Experiments. European Journal of Physics Proceedings.

Nuclear and Particle Futures

Directed Research
Continuing Project

Research Enabling a Next Generation Neutron Lifetime Measurement

Susan J. Seestrom
20140568DR

Introduction

The lifetime of the free neutron is a fundamental input to the Standard Model of particle physics. At present the experimental situation with lifetime measurements shows a distribution of values for the lifetime that is outside the claimed accuracy of these measurements. Trapped ultra-cold neutrons (UCN) show great promise to both resolve existing discrepancies and to push the precision of lifetime measurements to the level of 0.1 sec. A major focus of this project will be the implementation of a new technique for in situ detection of UCN inside the trap. In the first year, we will test a proto-type system to do this. Subsequent years will make improvements to this system based on the experience in the first year. In the third year we expect to make extended running to make an initial lifetime measurement with well-characterized uncertainties controlled at the level of 1 second.

This project will develop and apply two major innovations to the study of neutron decay with UCN. We will make the first measurement of the UCN lifetime using an asymmetric trap that will serve to minimize systematic uncertainties caused by marginally trapped neutrons. Our measurement will also be the first to make an in situ measurement of the number of trapped UCN, which will eliminate uncertainties introduced in the alternate technique of measuring the surviving neutrons by draining them from the trap. Measurements at comparable accuracy to the present suite of experiments – but with fundamentally different and understood systematic uncertainties – will be key in understanding why earlier measurements underestimated their systematic uncertainties

Benefit to National Security Missions

Better understanding the physical world - such as understanding the lifetime of the fundamental building blocks of matter, is central to the mission of the Office of science.

Nuclear physics experimental capability, specifically the ability to understand and make measurements with and about neutrons is a core capability of the nuclear weapons program which is sustained and advanced by this project.

Progress

UCN Trap loading and Transport

We conducted measurements to understand and improve the transport of polarized UCNs into the trap. The primary cause of low trap loading efficiency was found to be depolarization in a section of stainless steel guide in the assembly underneath the trap that includes the trap door actuator. An improved version of the assembly was already designed prior to the run based on suspected problems including this one with the original design; the other concern was the possibility of depolarization due to non-adiabatic magnetic field changes as UCNs move past the trap door magnets during loading. The improved assembly uses copper plates to minimize contact between UCNs and stainless steel surfaces, and moves the trap door down further and covers it with a copper flap during loading. A series of modifications were made during the run to the existing trap door assembly, culminating in a mock-up of the assembly planned for the next running period. The data show that the good loading efficiency in the simpler configurations is preserved in the mock-up, and we can expect an initial trap population of at least 1×10^5 UCNs per fill, which is consistent with the estimate in the December 2013 white paper of about 48 hours live time (assuming 50% UCN detection efficiency) to reach a statistical precision of $\delta\tau_n \approx 1$ second.

Vanadium-based in situ UCN Detector

An important part of the UCN τ experiment is a new method for counting the surviving neutrons in the trap using vanadium activation. The goal of this method is to avoid possible systematic errors due to a long, possibly phase-space dependent draining time which was

a feature of previous experiments, while maintaining low backgrounds and good signal-to-noise. In the present technique, a vanadium sheet is lowered into the trap, quickly absorbing neutrons which form ^{52}V , and then raised into a detector package that counts the coincident β (4 MeV endpoint) and γ (1.42 MeV) from ^{52}V decay.

Several improvements were made to the detector package:

- A 2"-thick lead shield was installed, reducing the gamma backgrounds by a factor of 6.3;
- The solid angle coverage of the gamma detector was improved by increasing the number of NaI detectors from two to eight;
- The beta detector scintillator paddles were replaced with phoswich scintillator (a sandwich of fast and slow scintillator) to enable selection of pulse shapes consistent with beta particles emitted from the vanadium sheet, thereby reducing backgrounds;

These improvements, along with the greatly improved UCN population in the trap as described above, have allowed us to evaluate the vanadium detector method well beyond what was possible with the proto-type system. The beta detector showed good efficiency of 89%. However, the gamma detector (NaI) efficiency of 22% is lower than bench top measurements of 60%. We have redesigned the vacuum extension (which houses the vanadium sheet in its raised position between the beta detectors) to achieve the expected factor of 3 increase.

We found a significant time-dependent background in the NaI detector that we attribute to the capture of thermal neutrons, which flood the room when the beam is on. Neutrons capture on ^{127}I to produce ^{128}I , which beta decays with a time constant of 2160 s and β endpoint energy of 2.1 MeV. This background can be reduced by adding a layer of borated polyethylene outside of the lead shield surrounding the vanadium detector assembly. In the beta detectors, one source of background is due to fast particles (cosmic rays and high energy Compton electrons) creating Cherenkov light in the light guides.

We have designed improved shielding and an improved light guide system for the Vanadium decay detector. These are presently being constructed and tested in the next LANSCE running period (beginning October 2014).

In addition to these items we have had a paper accepted for publication in Physical Review C, a paper on UCN gas scattering is in draft form, and multiple abstracts will be submitted on this work to the October APS meeting.

Future Work

In the second year of this project we will test improvements made based on the work of the first year. The improvements which will be tested and characterized are:

- A new trap door system to allow improved loading of ultra cold neutrons (UCN) into the trap.
- An improved system for detecting the decay products from the ^{52}V created when UCNs are captured. This will improve the efficiency of our system to measure the number of neutrons left in the trap after various storage times.
- We will install a new vacuum jacket that will contain our V dagger while the decay products are being counted. This will allow us to put an improved package of neutron shielding around the detector system to reduce backgrounds.
- Improved measurement of the lifetime of UCNs in various residual gases that could impact our lifetime measurements - this will allow us to determine the vacuum required in a sub-1second measurement of the lifetime.

Conclusion

The overall goal of the project will be to characterize all systematic uncertainties involved in using this system to make a measurement of the neutron lifetime at the level of 1 second. A new measurement at the 1-second level will lower the uncertainty of the PDG evaluation of the lifetime. The neutron lifetime is one of its basic properties. It is an important input to the standard model of cosmology and understanding primordial nucleosynthesis. Combining neutron lifetime with the other parameters of neutron decay can be used to construct sensitive tests of the standard model of particle physics.

Publications

Salvat, D. J., E. R. Adamek, D. Barlow, J. D. Bowman, L. J. Broussard, N. B. Callahan, S. M. Clayton, C. Cude-Woods, S. Currie, E. B. Dees, W. Fox, P. Geltenbort, K. P. Hickerson, A. T. Holley, C. Y. Liu, M. Makela, J. Medina, D. J. Morley, C. L. Morris, S. I. Penttilä, J. Ramsey, A. Saunders, S. J. Seestrom, E. I. Sharapov, S. K. Sjue, B. A. Slaughter, J. Vanderwerp, B. VornDick, P. L. Walstrom, Z. Wang, T. L. Womack, and A. R. Young. Storage of ultracold neutrons in the magnetogravitational trap of the τ experiment. 2014. Physical Review C. 89 (5): 052501.

Nuclear and Particle Futures

Directed Research
Final Report

TeV Jets: Nature's Particle Accelerators

Brenda L. Dingus
20120011DR

Abstract

Nature accelerates particles to energies exceeding 10 Joules—nearly a billion times higher than terrestrial accelerators—yet we do not know the origin of these particles or the mechanisms that produce them. They are produced outside our galaxy and they arrive at Earth from random directions due to their electrical charge and the long distances traveled through magnetic fields between galaxies and within our galaxy. However, these particles produce TeV gamma rays within their sources and these gamma rays travel straight to Earth to provide the most direct information about the physical mechanisms in these accelerators. The known extragalactic TeV gamma-ray sources contain jets of plasma accelerated to relativistic velocities and many exhibit rapid variability.

We have combined and extended LANL's observational, theoretical, and computational capabilities to study these extreme sources that test our understanding of high-energy particle and plasma physics in an environment irreproducible on Earth. The observational capabilities of the High Altitude Water Cherenkov (HAWC) gamma-ray observatory have been extended to lower energy gamma rays to better detect these extragalactic sources. This project funded photomultiplier tubes (PMTs) and a data acquisition system that was incorporated into the HAWC observatory. With these improvements, we have detected two extragalactic sources that show evidence of variability. The theoretical and computational capabilities at LANL have been expanded as well. We have developed a full suite of simulation tools from relativistic magnetohydrodynamics to particle-in-cell to multi-wavelength radiation modeling. These tools have been utilized to study the jet stability from black holes, acceleration of particles to TeV energies and their resultant radiation spectra. Such interconnected tools allowed us to place important constraints on the jet magnetic fields and polarization by comparisons between models and observations.

Background and Research Objectives

Observations of the intense TeV gamma-ray flares from Active Galactic Nuclei (AGN) have shown that relativistic astrophysical jets powered by supermassive black holes accelerate individual particles to extreme energies and they are the leading candidates for sources of the highest energy cosmic rays. Understanding cosmic accelerators is a major challenge in high-energy particle physics and plasma astrophysics, and TeV observations from AGN jets provide some of the strongest constraints. This is listed as one of the 11 key science questions in the National Academy of Sciences 2006 report "From Quarks to the Cosmos" and is further emphasized in the Astro2010 Decadal Survey in Astronomy and Astrophysics.

The HAWC gamma-ray observatory has a unique capability to study the highest energy gamma rays from astrophysical sources because of its wide field of view and continuous observations allowing over 2/3 of the sky to be observed each day. HAWC was constructed with DOE/SC HEP and NSF funding by a collaboration of LANL, 15 US universities, and 15 Mexican universities. This LDRD project extended the capabilities of HAWC to detect the lower energy gamma rays produced by AGN by adding 300 large, high quantum efficiency PMTs that were not in the project baseline. The improved sensitivity of HAWC allows more AGN to be detected as well as shorter duration flares from AGN. HAWC is now a premier observatory for studying particle acceleration, and first results have already shown the detection of two AGN by HAWC.

The extreme energies and time variabilities of TeV emissions highlight the need to understand the energy conversion mechanism from magnetic fields to highly relativistic particles. Macroscopic fluid models have shown that the process of magnetic reconnection can accelerate particles to high energies, as observed in the Sun and neutron star environment. This project enabled us to develop several first principle plasma astrophysics

models to determine the particle acceleration mechanism. Three dimensional models of jet stability, magnetic field dissipation and particle acceleration have now been coupled together to produce physics-based variability, magnetic field structure, polarization and radiation spectra that have been compared with observations from multi-wavelength emissions from these sources.

Scientific Approach and Accomplishments

Prior to the construction of HAWC, the highest energy gamma rays from AGN could only be studied with pointed telescopes that observe one source at a time, and only worked on moonless clear nights, making it difficult to catch rare flares from AGN as well as search for more AGN. HAWC works 24/7, searching 2/3 of the sky each day for new AGN and flares from known AGN, detecting gamma rays via the particles that a gamma ray produces in the Earth's atmosphere. HAWC is located at 13500' above sea level near the Pico de Orizaba—Mexico's tallest mountain, to catch the particles before they die away on the way to sea level. The particles register by producing the Cherenkov light in HAWC's array of 300 close-packed water tanks. Figure 1 shows the HAWC observatory and the water tanks, each containing 50,000 gallons of water. A single gamma ray produces a shower of particles that impacts many tanks in the array all within a very short time interval. The time that each tank is hit is fit to a plane, which is perpendicular to the direction of the initial gamma ray.

With this LDRD project, HAWC's sensitivity to detect lower energy gamma rays was increased. AGN spectra are dominated by lower energy gamma rays because the higher energy gamma rays are attenuated in distant extragalactic sources. However, lower energy gamma rays produce fewer particles in the atmosphere and therefore less Cherenkov light in the HAWC tanks. LDRD funding was used to increase the Cherenkov detection efficiency with the addition of more PMT detectors. As the energy threshold of HAWC was decreased, the rate of showers increased, and the increased data rate required a data acquisition system that continuously records 500 Mbytes/second. Finally, new analysis tools were also developed to search for transient sources and to improve the statistical tools to mine this large data set. Specific capabilities that were created with this LDRD project include:

- A multi-PMT testing facility was constructed. PMTs were tested and characterized for various parameters, such as relative photodetection efficiency, gain versus high voltage, and timing. A short-pulsed laser was used as well as a Cherenkov photon source. Each PMT was then assigned appropriate operating voltages and locations within the HAWC array.

- The HAWC data acquisition system was developed to record all Cherenkov photons detected by all PMTs. The data is then farmed to multiple computers for selecting time intervals containing showers of particles from even the lowest energy gamma rays. The system is also flexible enough to allow special triggers, such as those for slow moving particles like Q-balls. Peter Karn, a graduate student from University of California Irvine worked at LANL, developed such a Q-ball trigger upon which he based his Ph.D. thesis.
- Software analysis tools have been written to study gamma-ray signals from AGN. Special triggers for lower energy gamma rays have been investigated. Transient search algorithms that account for the time variable background have been implemented. And statistical likelihood based tests are being applied to HAWC data to mine the petabyte data set for evidence of gamma ray sources.

HAWC began collecting data in August 2013 with one third of the detector operating. The first results from approximately half a year of data collection are shown in Figure 2. Several previously known gamma-ray sources are significantly detected including two AGN. The rest of the HAWC detector is nearly complete and HAWC operations are planned for at least 5 years. The increased capabilities provided by this LDRD project have been integrated into the HAWC detector and will be operated with the rest of the detector with DOE and NSF funding and will result in more detections in the future.

On the theory and simulation front, we have made significant progress in developing a full suite of simulation tools that cover the relativistic magnetohydrodynamic (MHD) physics to relativistic particle acceleration via particle-in-cell (PIC) and the high energy radiation from these accelerated particles. Such a suite of simulation tools enable us to carry out first-principle studies of relativistic astrophysical jet formation, propagation, as well as the energy dissipation processes. In fact, some of these tools represent the state-of-the-art in the community and the interconnected nature of this tool suite makes this a unique capability of LANL in modeling these high-energy astrophysical systems. Specifically, we will discuss four areas that were enabled by the LDRD support:

We have performed extensive relativistic MHD simulations to study the jet propagation and stability, powered by the supermassive black holes [1]. We developed a relativistic MHD code that allows nonuniform grids. This enabled us to extend the simulation domain with a large dynamic range, which permitted us to study the jet evolution spanning a longer time and larger distances. We found that the

relativistic jet, albeit exhibiting current-driving instabilities, still stays quasi-coherent and is able to propagate to very large distances (e.g., more than 1000 times larger than the injection region). This is the first time that the magnetic tower model for astrophysical jets has been demonstrated in the relativistic limit and it shows that such jets do experience instabilities yet can maintain their integrity. This addresses a long-standing question in jet studies on why jets can travel to enormous distances without complete disruption. Such jet structures provide an important opportunity for us to compare the simulation results with jet observations.

Based on the relativistic MHD jet simulations, we investigated how the current driven instabilities will lead to the formation of intense current sheets. We find that the instability produces multi-scale fluctuations that nonlinearly interact with each other, causing magnetic energy to cascade to smaller scales. At small scales the magnetic structures are not random, instead, they form current sheets that possess characteristic shapes and length scales. This offers the opportunity to construct current sheet models that can connect the injection and dissipative scales. This is important in using the fluid scale simulations as inputs for kinetic scale simulations.

We have carried out extensive particle-in-cell simulations to study the relativistic reconnection to understand how magnetic fields are dissipated and how particles are accelerated. Some of these simulations rank as the largest-ever in this type of studies. One particular regime we investigated contains a magnetically dominated limit in which the magnetic energy density is > 1000 times larger than the rest mass energy density of the particles. We uncovered a new particle acceleration process associated with the magnetic reconnection, namely through a first-order Fermi process resulting from the curvature drift of particles in the direction of the electric fields induced by the relativistic outflows resulted from reconnection [2]. Figure 3 shows the current density distribution in three dimensions as the nonlinear outcome of the reconnection. One very interesting outcome of this process is the formation of power-law electron energy distribution, which has important applications to a broad range of high-energy astrophysical systems, such as jets and lobes from supermassive black holes, flares from neutron stars, and gamma-ray bursts. In fact, HAWC is ready to observe all of these sources.

With this sequence of simulation capabilities and results obtained, we have applied our tools to model a few high-energy astrophysical sources in terms of fitting their multi-wavelength spectra, time variability and polarization properties. We found that the polarization properties provide some of the most important constraints on understanding

the magnetic field structure in jets. Using this field structure, we are performing fits to observed spectra from jets.

Impact on National Missions

Understanding cosmic accelerators is a major challenge in high-energy particle physics and plasma astrophysics, and gamma-ray observations provide some of the strongest constraints. The DOE Office of Science has funded both observational and theoretical scientists on this project at LANL to work in this area. The PI of this project was elected by the HAWC collaboration as the US spokesperson and DOE High Energy Physics (HEP) program supported her to do this science as well as be the Deputy Project Manager for the HAWC construction project and the Run Manager for the HAWC operations. HAWC was a DOE Major Item of Equipment (MIE) for DOE that resulted in a total of \$3M of funding to LANL in FY2012 and FY2013. This work also increased LANL's scientific capabilities in computational astrophysics and plasma physics, and contributed strongly to NNSA national security programs by utilizing the state of the art simulation tools and tests petascale computing codes that have major influences on the future of the ASC program.

In addition, this project attracted several young physicists to work at LANL. The observational effort involved three postdocs -- one of which is now a staff member in P-23 and is working on sub-critical nuclear experimentation, one is continuing to work on HAWC with DOE funding, and one is now working in private industry. The theoretical effort involved four postdocs and two graduate students. One postdoc is now a staff member in Naval Research Labs, one has a NASA postdoc fellowship, one continues to work with us and one is in private industry. Overall, we have published more than 20 papers in the refereed journals (with several more in preparation) and have given many invited talks at various conferences.



Figure 1. Photograph of the HAWC observatory that has been constructed over the last 3 years in Mexico. The site is at 13500' elevation and the mountain behind is Pico de Orizaba, the tallest mountain in Mexico at 18500'.

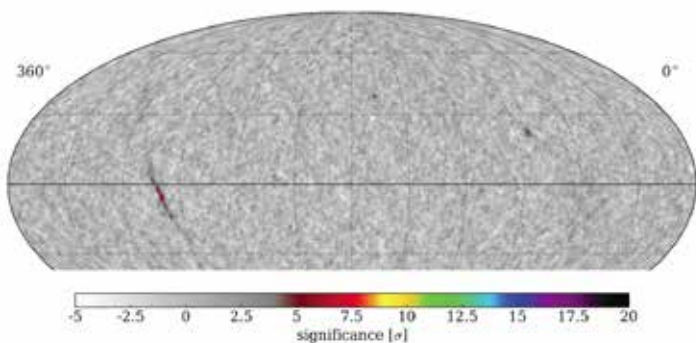

Figure 2. HAWC's first map of the TeV sky. The Crab Nebula is a bright known source that is over 10 standard deviations. The active galactic nuclei Mrk421 and Mrk501 are both significantly detected. Also, sources within the plane of the galaxy and towards the galactic center are being detected.

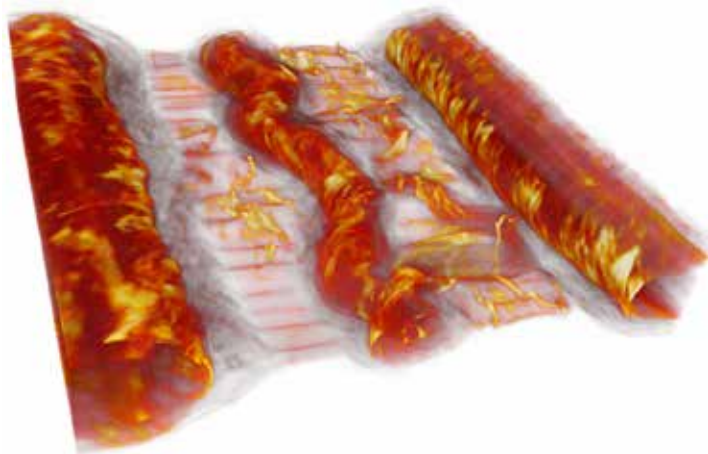

Figure 3. Three-dimensional VPIC simulation of reconnection in relativistic pair plasma with $\sigma=100$. Shown is a volume rendering of the current density. It shows that both the collisionless tearing instability and the kink instability are operating in the reconnection region. Significant magnetic energy dissipation has been observed in this current layer and a large fraction of magnetic energy goes into accelerating particles to highly relativistic energies. This simulation employed 2048^3 cells with 1.4 trillion particles, and was performed using 131K cores of BlueWaters. (For further details, see Fan et al, PRL, 2014.)

References

1. Guan, X., H. Li, and S. Li. RELATIVISTIC MHD SIMULATIONS OF POYNTING FLUX-DRIVEN JETS. 2014. ApJ. 781: 48.
2. Guo, F., H. Li, W. Daughton, and Y. H. Liu. Formation of Hard Power-laws in the Energetic Particle Spectra Resulting from Relativistic Magnetic Reconnection. To appear in PRL.

Publications

Abdo, A. A.. Milagro Observations of Potential TeV Emitters. 2014. Astroparticle Physics. 57: 16.

Abdo, A. A.. The Study of TeV Variability and the Duty Cycle of Mrk 421 from 3 yr of Observations with the Milagro Observatory. 2014. Astrophysical Journal. 782: 110.

Abdo, A. A., A. U. Abeysekara, B. T. Allen, T. Aune, D. Berley, C. Chen, G. E. Christopher, T. DeYoung, B. L. Dingus, R. W. Ellsworth, M. M. Gonzalez, J. A. Goodman, J. Granot, E. Hays, C. M. Hoffman, P. H. Huntemeyer, B. E. Kolterman, J. T. Linnemann, J. E. McEnery, A. I. Mincer, T. Morgan, P. Nemethy, J. Pretz, E. Ramirez-Ruiz, J. M. Ryan, P. M. S. Parkinson, A. Shoup, G. Sinnis, A. J. Smith, V. Vasileiou, G. P. Walker, D. A. Williams, and G. B. Yodh. CONSTRAINTS ON THE EMISSION MODEL OF THE "NAKED-EYE BURST" GRB 080319B. 2012. ASTROPHYSICAL JOURNAL LETTERS. 753 (2): -.

Abdo, A. A., B. T. Allen, R. Atkins, T. Aune, W. Benbow, D. Berley, E. Blaufuss, E. Bonamente, J. Bussons, C. Chen, G. E. Christopher, D. G. Coyne, T. DeYoung, B. L. Dingus, D. E. Dorfan, R. W. Ellsworth, A. Falcone, L. Fleysher, R. Fleysher, J. Galbraith-Frew, M. M. Gonzalez, J. A. Goodman, T. J. Haines, E. Hays, C. M. Hoffman, P. H. Huntemeyer, L. A. Kelley, B. E. Kolterman, C. P. Lansdell, J. T. Linnemann, J. McCullough, J. E. McEnery, T. Morgan, A. I. Mincer, M. F. Morales, P. Nemethy, D. Noyes, J. Pretz, J. M. Ryan, F. W. Samuelson, P. M. S. Parkinson, A. Shoup, G. Sinnis, A. J. Smith, G. W. Sullivan, V. Vasileiou, G. P. Walker, M. Wascko, D. A. Williams, S. Westerhoff, and G. B. Yodh. OBSERVATION AND SPECTRAL MEASUREMENTS OF THE CRAB NEBULA WITH MILAGRO. 2012. ASTROPHYSICAL JOURNAL. 750 (1): -.

Abdo, A. A., U. Abeysekara, B. T. Allen, T. Aune, D. Berley, E. Bonamente, G. E. Christopher, T. DeYoung, B. L. Dingus, R. W. Ellsworth, J. G. Galbraith-Frew, M. M. Gonzalez, J. A. Goodman, C. M. Hoffman, P. H. Huntemeyer, C. M. Hui, B. E. Kolterman, J. T. Linnemann, J. E. McEnery, A. I. Mincer, T. Morgan, P. Nemethy, J. Pretz, J. M. Ryan, P. M. S. Parkinson, A. Shoup, G. Sinnis, A. J. Smith, V. Vasileiou, G. P. Walker, D. A. Williams, and B. Yodh. SPECTRUM AND MORPHOLOGY OF THE TWO BRIGHTEST MILAGRO SOURCES IN THE CYGNUS REGION: MGRO J2019+37 AND MGRO J2031+41. 2012. ASTROPHYSICAL JOURNAL. 753 (2): -.

Abeysekara, A. U., J. A. Aguilar, S. Aguilar, R. Alfaro, E. Almaraz, C. Alvarez, J. D. Alvarez-Romero, M. Alvarez, R. Arceo, J. C. Arteaga-Velazquez, C. Badillo, A. Barber, B. M. Baughman, N. Bautista-Elivar, E. Belmont, E. Benitez, S. Y. BenZvi, D. Berley, A. Bernal, E. Bonamente, J. Braun, R. Caballero-Lopez, I. Cabrera, A. Carraminana, L. Carrasco, M. Castillo, L. Chambers, R. Conde, P. Condey, U. Cotti, J. Cotzomi, J. C. D'Olivo, E. de la Fuente, C. De Leon, S. Delay, D. Delepine, T. DeYoung, L. Diaz, L. Diaz-Cruz, B. L. Dingus, M. A. Duvernois, D. Edmunds, R. W. Ellsworth, B. Fick, D. W. Florino, A. Flandes, N. I. Fraija, A. Galindo, J. L. Garcia-Luna, G. Garcia-Torales, F. Garfias, L. X. Gonzalez, M.

- M. Gonzalez, J. A. Goodman, V. Grabski, M. Gussert, C. Guzman-Ceron, Z. Hampel-Arias, T. Harris, E. Hays, L. Hernandez-Cervantes, P. H. Huntemeyer, A. Imran, A. Iriarte, J. J. Jimenez, P. Karn, N. Kelley-Hoskins, D. Kieda, R. Langarica, A. Lara, R. Lauer, W. H. Lee, E. C. Linares, J. T. Linnemann, M. Longo, R. Luna-Garcia, H. Martinez, J. Martinez, L. A. Martinez, O. Martinez, J. Martinez-Castro, M. Martos, J. Matthews, J. E. McEnery, G. Medina-Tanco, J. E. Mendoza-Torres, P. A. Miranda-Romagnoli, T. Montaruli, E. Moreno, M. Mostafa, M. Napsuciale, J. Nava, L. Nellen, M. Newbold, R. Noriega-Papaqui, T. Ocegueda-Becerra, A. O. Tapia, V. Orozco, V. Perez, E. G. Perez-Perez, J. S. Perkins, J. Pretz, C. Ramirez, I. Ramirez, D. Rebello, A. Renteria, J. Reyes, D. Rosa-Gonzalez, A. Rosado, J. M. Ryan, J. R. Sacahui, H. Salazar, F. Salesa, A. Sandoval, E. Santos, M. Schneider, A. Shoup, S. Silich, G. Sinnis, A. J. Smith, K. Sparks, W. Springer, F. Suarez, N. Suarez, I. Taboada, A. F. Tellez, G. Tenorio-Tagle, A. Tepe, P. A. Toale, K. Tollefson, I. Torres, T. N. Ukwatta, J. Valdes-Galicia, P. Vanegas, V. Vasileiou, O. Vazquez, X. Vazquez, L. Villaseñor, W. Wall, J. S. Walters, D. Warner, S. Westerhoff, I. G. Wisher, J. Wood, G. B. Yodh, D. Zaborov, and A. Zepeda. On the sensitivity of the HAWC observatory to gamma-ray bursts. 2012. *ASTROPARTICLE PHYSICS*. 35 (10): 641.
- Aluie, H., Shengtai Li, and Hui Li. Conservative Cascade of Kinetic Energy in Compressible Turbulence. 2012. *Astrophysical Journal, Letters*. 751 (2): L29 (6 pp.).
- Beresnyak, A., H. Xu, H. Li, and R. Schlickeiser. MHD Turbulence and Cosmic Ray Reacceleration in Galaxy Clusters. 2013. *Astrophysical Journal*. 771: 131.
- Beresnyak, A., and H. Li. First Order Particle Acceleration in Magnetically-Driven Flows. PRL.
- Chen, , Chatterjee, Zhang, Pohl, Fossati, Boettcher, C. D. Baily, E. W. Bonning, Buxton, Coppi, Isler, Maraschi, and M. e. g. Urry. Magnetic field amplification and flat spectrum radio quasars. 2014. *MONTHLY NOTICES OF THE ROYAL ASTRONOMICAL SOCIETY*. 441 (3): 2188.
- Colgate, S. A., T. K. Fowler, H. Li, and Pino. QUASI-STATIC MODEL OF COLLIMATED JETS AND RADIO LOBES. I. ACCRETION DISK AND JETS. 2014. *ASTROPHYSICAL JOURNAL*. 789 (2).
- Govoni, F., M. Murgia, H. Xu, H. Li, M. L. Norman, L. Feretti, G. Giovannini, and V. Vacca. Polarization of cluster radio halos with upcoming radio interferometers. 2013. *ASTRONOMY & ASTROPHYSICS*. 554: -.
- Guan, , H. Li, and Li. RELATIVISTIC MHD SIMULATIONS OF POYNTING FLUX-DRIVEN JETS. 2014. *ASTROPHYSICAL JOURNAL*. 781 (1).
- Guo, F., H. Li, W. Daughton, and Y. H. Liu. Formation of Hard Power-law in the Energetic Particle Spectra Resulting from Relativistic Magnetic Reconnection. To appear in PRL.
- Liu, , Daughton, Karimabadi, Li, and S. P. Gary. Do dispersive waves play a role in collisionless magnetic reconnection?. 2014. *PHYSICS OF PLASMAS*. 21 (2).
- Liu, Y. H., F. Guo, W. Daughton, H. Li, and M. Hesse. Scaling of the reconnection inflow speed and rate in relativistic collisionless plasmas. PRL.
- Liu, Y. H., W. Daughton, H. Li, H. Karamabadi, and V. Roytershteyn. Bifurcated Structure of the Electron Diffusion Region in Three-Dimensional Magnetic Reconnection. 2013. *Phys. Rev. Lett.*. 110: 265004.
- Si, , S. A. Colgate, H. Li, J. Martinic, and Westpfahl. Data acquisition in a high-speed rotating frame for New Mexico Institute of Mining and Technology liquid sodium alpha omega dynamo experiment. 2013. *REVIEW OF SCIENTIFIC INSTRUMENTS*. 84 (10).
- Skillman, S., H. Xu, E. Hallman, B. O'Shea, J. Burns, H. Li, D. Collins, and M. Norman. Cosmological MHD Simulations of Galaxy Cluster Radio Relics: Insights and Warnings for Observations. 2013. *Astrophysical Journal*. 765: 765.
- Xu, H., F. Govoni, M. Murgia, H. Li, D. Collins, M. Norman, and R. Cen. Evolution and Comparisons of Cosmological MHD Galaxy Cluster Simulations to Radio Observations. 2012. *Astrophysical Journal*. 759: 40.
- Yang, C., S. Liu, J. Fang, and H. Li. The Structure of TeV-Bright Shell-Type Supernova Remnants. To appear in *Astronomy and Astrophysics*.
- Zhai, , H. Li, P. M. Bellan, and Li. THREE-DIMENSIONAL MHD SIMULATION OF THE CALTECH PLASMA JET EXPERIMENT: FIRST RESULTS. 2014. *ASTROPHYSICAL JOURNAL*. 791 (1).
- Zhang, , Chen, and Boettcher. SYNCHROTRON POLARIZATION IN BLAZARS. 2014. *ASTROPHYSICAL JOURNAL*. 789 (1).

Hydrodynamical Mix Studies at the National Ignition Facility (U)

Michael J. Steinkamp
20120072DR

Abstract

Turbulent mixing in strongly compressible converging flows, with Thermonuclear (TN) energy release, is an extremely challenging physical problem. This project focuses on advancing our understanding of the interplay between mix and burn through a combined experimental and theoretical approach. We have coupled a theoretical and computational investigation using Los Alamos National Laboratory's (LANL's) state-of-the-art Besnard-Harlow-Rauenzahn (BHR) turbulence transport model [1] in the Advanced Simulation and Computing (ASC) Eulerian Applications Project (EAP) code suite with an experimental program utilizing the extreme conditions (converging flow with TN burn) available at the National Ignition Facility (NIF). We implemented a new physics based sub-grid model of TN burn in an ASC code, and have demonstrated the veracity of the EAP code suit for use in NIF implosion simulations. This has allowed us to validate the BHR turbulence model in a convergent geometry using experimental data collected at NIF and Omega using separated reactants. Indeed, this initiative has provided a new class of experimental data to advance our understanding of turbulence in these flows, including the first TN data to test the BHR turbulence model at small scales. Another major achievement is the development of a method to measure Reaction-In-Flight (RIF) neutrons at NIF using nuclear activation, allowing us to observe RIF signals at NIF. This measurement constitutes the first time RIF's have been measured in an Inertial Confinement Fusion (ICF) environment. We have also developed prompt radiochemical assay systems that allow post-shot detection of 200 ms half-lives on NIF with yields as high as $1E17$, and we are now involved in NIF relevant solid debris collection schemes in collaboration with Lawrence Livermore National Laboratory (LLNL).

Background and Research Objectives

The overarching goal of this project was to advance LANL's ICF predictive modeling capability, and to provide

TN burn data in a compressible, convergent, and turbulent environment for the shortest length scales practicable. The interaction between mix and TN burn is of fundamental physical interest, and it significantly affects the physics in systems from type 1a supernovae to nuclear weapons [2,3,4,5,6,7,8,9]. To accomplish our objectives, we followed three distinct, yet intimately coupled, efforts: (1) we developed a radiochemical procedure that exploits RIF neutrons to measure the Charged Particle (CP) stopping power in an ICF plasma, (2) we developed a state-of-the art computational sub-grid model of TN burn in a mixed ICF plasma within an ASC code, and (3) we took validation data from well-diagnosed mix and burn experiments at NIF and Omega.

The stopping power was probed by knock-on ions produced from TN reactions. These ions lose energy as they traverse the plasma, and this directly affects the number and energy spectrum of the produced RIF neutrons. For this analysis, it is important to note how RIF neutrons are created [10], as illustrated in Figure 1. First, a primary 14.1 MeV Deuterium-Tritium (D-T) neutron is produced; this high-energy neutron undergoes elastic scattering with D or T ions in the plasma, energetically up-scattering these ions to a range of energies from zero to more than 10 MeV. Finally, this energetic knock-on ion undergoes a D-T reaction with a thermal ion in the plasma, producing a continuous spectrum of RIF neutrons in the energy range 9.2-30 MeV. The knock-on fluence is inversely proportional to the CP stopping power of the ion [10,11], and therefore measuring the fluence will provide a determination of the stopping power, provided the proportionality constant is known. This constant can be determined by the integral of the knock-on fluence over the D-T cross-section weighted by the D-T ion density. Thus, measurements of RIF neutrons at NIF can be used to determine the stopping power in the capsule. In the case of cryogenic NIF capsules, RIF's probe the strongly coupled and degenerate plasma regime, which represents stopping in previously, unexplored plasma

conditions.

A set of well-defined turbulence mix experiments were designed and carried out at NIF [12,13,14]. At this facility, one can vary the shock loading conditions and fabricate capsules with interfacial characteristics intended to influence the growth of instability and hydrodynamic mixing. These experiments have been diagnosed using a combination of neutron and x-ray imaging [15,16,17,18,19,20,21,22,23,24, 25] and reaction history. The BHR model has a unique ability to predict chunkiness, and this NIF data provides unique BHR validation at appropriate scales and burn conditions. The ICF-relevant physics models contained within the EAP code suite allow us to calculate explicitly the impact of turbulent mixing on the observables we measured at NIF. All aspects of our project benefit from this intentionally tight coupling of theory, modeling, and experimental design.

By carefully controlling capsule design and drive conditions, the baseline NIF program focused on engineering TN burn in the absence of mix. In contrast, our focus was to characterize and quantify TN burn in the presence of mix. Hence, the goals of each experimental program were fundamentally different, resulting in dramatically different experimental designs. Our LDRD project simultaneously leveraged other NIF experimental activities, while supporting key LANL scientific personnel (G. Grim), stationed at LLNL; contributing his expertise in experimental design, fielding, and analysis of neutron imaging data, as well as neutron spectra from LANL's neutron time-of-flight (nToF) diagnostic. In addition to already impacting the ASC ICF modeling capability, we expect the deliverables of this project will substantially impact NIF's future baseline program, once their focus shifts to capsules containing turbulent mix.

Scientific Approach and Accomplishments

In FY12 we developed a 1-D ICF burn code, CPT-Implode [11], to study [26,27,28,29] the sensitivity to mix of radchem RIF neutrons. The standard Los Alamos High Foot ignition capsule involves a beryllium ablator, and we quantified how well the reaction $9\text{Be}(n,p)9\text{Li}$ could be used to determine the implosion velocity in a NIF capsule. The Doppler shift due to the velocity of the ablator has a large impact on the production of 9Li , and we found that the ratio $9\text{Li}/28\text{Al}$ closely scales with the implosion velocity. This is illustrated in Figure 2. This ratio also tracks directly with the fraction of the yield (YBO) that is produced before the ablator shell changes direction from an imploding to an exploding geometry. We then added a RIF neutron production package to the code, from which we found that RIF's are only produced at a detectable level in cryogenic NIF ignition design capsules. On the experimental side, we started the low mode (large scale) diagnosis of mix via

burn signatures, which included measuring ΔYield , Tion, and burn imaging. We also implemented burn diagnostics (with some optimizations).

In conjunction with radchem analysis, in FY13 we developed and implemented a TN burn sub-grid model into the EAP suite of codes [30,31,32]. Sub-grid model development must capture unresolved variations in composition, density, pressure, and temperature within a single computational cell, along with degrees of material "mixedness." Stirring leads to regions that are identifiable as parent material, while molecular mixing leads to intimate molecular or atomic contact between volumes of different species. The current mix model in the ASC code assumes that the molecular scales are directly and immediately tied to the large scales of turbulent motions. The sub-grid model uses an assumed "beta" Probability Distribution Function (PDF) where the coefficients are calculated from the first two moments of concentration obtained from the turbulence transport model. Thus far, this sub-grid model has been applied to a wide range of test cases with excellent results [33,34,35,36]. This model does not have unknown coefficients that require calibration from experiment, but instead uses the output from BHR as its own input.

A major success of this LDRD was the detection of RIF neutrons at NIF in FY13. The first positive RIF signals were seen in March of 2013 for NIF shot N130331 [37,20,21,23,24]. The measured signal corresponds to a RIF/total neutron ratio of 1.5×10^{-4} . These measurements represent the first observation of RIFs in any ICF system. RIF detection was achieved at NIF by measuring neutrons with energies above 15 MeV via neutron activation of thulium foils. The $(n,3n)$ reaction on natural thulium (^{169}Tm) is a threshold reaction, requiring $E_n > 15$ MeV and producing ^{167}Tm . The experiments were designed to search for the presence of ^{167}Tm , which decays with a half-life of 9.25 days by electron capture to ^{167}Er , with the emission of a 207.79 keV gamma ray 41% of the time. The primary experimental challenge for the ^{167}Tm measurements was the huge background of gamma-rays produced in the activation of the foils by the much higher fluence of primary 14 MeV neutrons, in particular those from ^{168}Tm (with a half life of 93.1 days). Thus, suppression of background gamma-rays was crucial in the experiments. To achieve this suppression, the activated foils were shipped to LANL, where two clover detectors were deployed to assay the ^{168}Tm and ^{167}Tm activity in the foils. Figure 3 shows the measured 208 keV peak for NIF shot N140304. Here the measured ratio of $^{167}\text{Tm}/^{168}\text{Tm}$ was $1.69 \pm 0.24 \times 10^{-5}$. The 208 keV signals in all shots measured consistent with the half-life of ^{167}Tm [37,20,21,23,24,11].

In the experimental component of FY13, we began looking

at higher mode (mid scale) mix diagnosis using RIF neutron burn signals. The experimental team measured RIF signals on all subsequent cryogenic NIF shots (FY13, FY14), while the theory team concentrated on analyzing these shots.

We also began looking at mix induced burn signatures (short scales). Experimental data from 12 MIXCAP [38] shots conducted during FY13-FY14 at NIF were analyzed and modeled, providing BHR model validation data. The MIXCAP platform uses an indirectly driven capsule where the nuclear reactants are separated between the capsule material and gas fill to allow for diagnosing the atomic mixing of shell material with the gas payload. The experimental data collected includes both X-ray and nuclear data, including neutron images for D+T and T+T fusion neutrons. We took the first TT and DT mix neutron images during these experiments. In addition to NIF based MIXCAP experiments, data from ten directly-driven MIXCAP implosions were collected at Omega. The Omega experiments were funded entirely by this project.

These data constrain CP stopping models in a Fermi degenerate plasma, with significant impact within the Weapons Program. The RIF production at peak burn, predicted from our simulations and from full 3-D HYDRA [39] runs, originates in the shocked cold fuel, with fewer than 10% produced in the hot spot. At peak capsule compression, the outer dense DT fuel is at a temperature of a fraction of a keV, and a density approaching 1026 cm^{-3} . The cold fuel is degenerate, with the electron temperature being a factor of 3-5 below the Fermi temperature. We have analyzed all of the RIF data from all shots with positive signals, using full 3-D simulations, constrained by a broad range of experimental data. We carried out a second independent analysis of the RIFs using CPT-Implode. In both cases, we varied the stopping models and examined the change in the shape of the predicted RIF spectrum and its effect on the RIF ratio. These plasma conditions allow the differentiation of several stopping power models in the literature, as illustrated in Figure 4 [11,40,41,42].

To validate the sub-grid model, our experimental campaign goals for FY14 were: (1) conduct separated reactant experiments [43] at Omega; (2) measure RIF's at NIF; (3) continue development of prompt radiochemical assay capability for NIF; (4) participate in NIF solid debris collection experiments [49]; and, (5) participate in LLNL lead NIF indirect drive separated reactant experiments [43]. To aid in the experimental data analysis, we developed a Monte Carlo package allowing us to simulate the response of scintillator telescopes to various beta-decaying elements produced at both experimental facility. This allows us to identify the elements produced as well as their abundance during shot days at the facilities. We have designed a novel 4-element

prototype for Omega, fielded in FY13. Excellent progress on all five activities was accomplished in FY14. The capability to diagnose RIF neutrons at NIF represents an important milestone for this project, as the ability to disentangle CP stopping and mix requires two independent measures of the conditions of a partially degenerate plasma.

To facilitate our goal of establishing the technical basis for performing prompt radiochemical measurements at NIF, we have designed a new scintillator telescope for the measurement of fast decaying elements, as seen in Figure 5. This second detector was fielded at Omega, with different activation targets. These experiments enabled comparison of data with Geant4 [44] simulation results, enabling us to extract the relative composition of activated materials and an extraction of the background. These tests along with other improvements in the readout hardware have roughly doubled the acquisition speed, and currently we are working on improving this by an additional factor of 10. In parallel we are working on developing our own prototype of a digitizer, but have yet to perform the actual debris collection experiments.

Impact on National Missions

This project has advanced LANL's state-of-the-art Eulerian ASC ICF modeling capability [45,46,47,48,33], and developed new experimental diagnostics for NIF, directly addressing NNSA's goal of fostering a scientific program at NIF of both broad scientific interest and specific utility to the weapons program. This project has spawned 4 follow-on FY15 programmatic mission-centric projects; namely, (1) the Bromine-doped High-Foot experiment on NIF, with a goal to measure knock-on deuteron reactions on Br [43,44], and develop a nToF RIF capability to determine the shape of the RIF neutron spectrum at NIF; (2) the LANL Marble Project [50], designed to study TN burn in the presence of mix between reactants and non-reactants using an ICF platform. Marble ICF capsules are filled with engineered foams, designed to produce a substantial yet controllable amount of mixing during the capsule implosion. By altering the foam geometry, it is possible to alter both the rate at which materials mix and the mix morphology (providing experimental data to identify dominant physical processes that effect mix in TN burn). Under Marble, many of the capabilities developed in this DR will continue to mature and impact the direction of the LANL High Energy Density physics program. The RIF diagnostics and the sub-grid burn modeling, have already positively impacted LANL's programs, resulting in fundamental changes in ICF modeling; and, (3) support to the LLNL Based Clover Detector Project, where LANL will design and construct a new 4-PI clover geometry High Purity Germanium detector with a NaI Compton suppression shield for use in measuring

short half-lived radio-isotopes produced in NIF implosions. This new detector will extend the RIF neutron measurement capability at NIF, as well as open up reaction channels that produce half-lives as short as 1-2 hours, and (4) in collaboration with the University of California (UC), Lawrence Berkeley Laboratory (LBL), and LLNL, another follow-on project is the creation of a new UC Office of President (UCOP) Project on Fundamental and Applied High Energy Science at NIF.

To jump-start a new UC Center for High Energy Density Science, focused on fundamental plasma physics experiments at NIF, UC granted our collaboration \$250K for workshops and student support. A longer-term \$2.5M proposal has been submitted to UC for this new center.

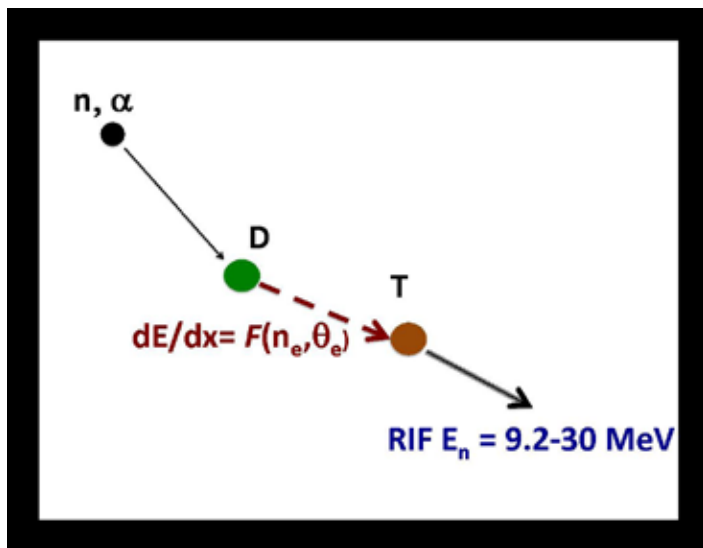

Figure 1. The three consecutive steps involved in RIF production.

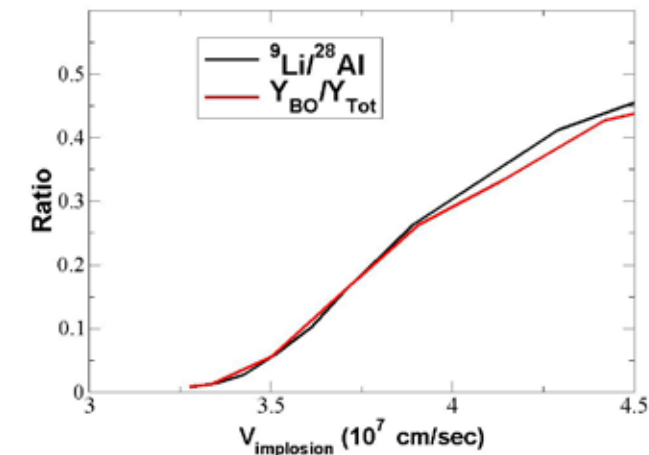

Figure 2. The sensitivity of the $9\text{Be}(n,p)9\text{Li}$ reaction yield to the implosion velocity. The ^{28}Al is produced via the (n,p) reaction on ^{28}Si dopant in the ablator. The $9\text{Li}/^{28}\text{Al}$ ratio tracks with the fraction of the yield produced before the ablator turns around.

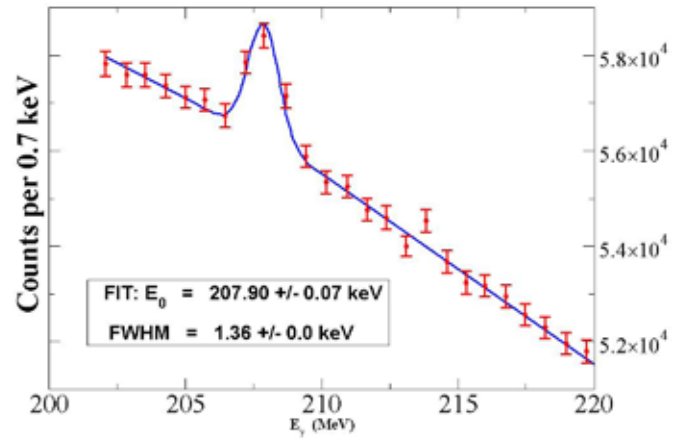

Figure 3. The 208 keV peak from the decay of ^{167}Tm for the shot N140304. The corresponding measured ratio of $^{167}\text{Tm}/^{168}\text{Tm}$ was $1.69 \pm 0.2 \times 10^{-5}$

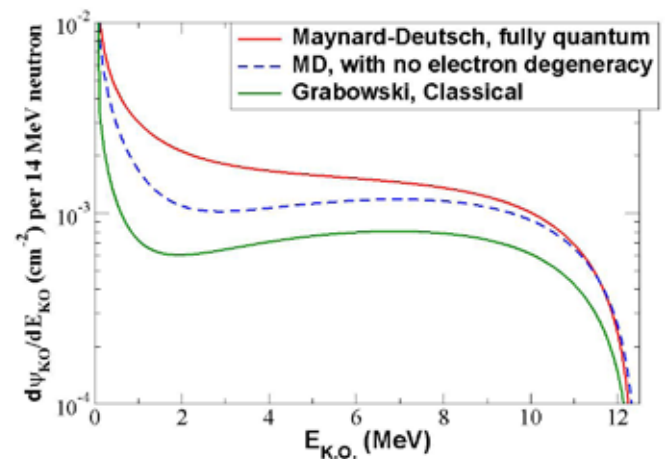

Figure 4. The knock-on deuteron fluence for different stopping models.

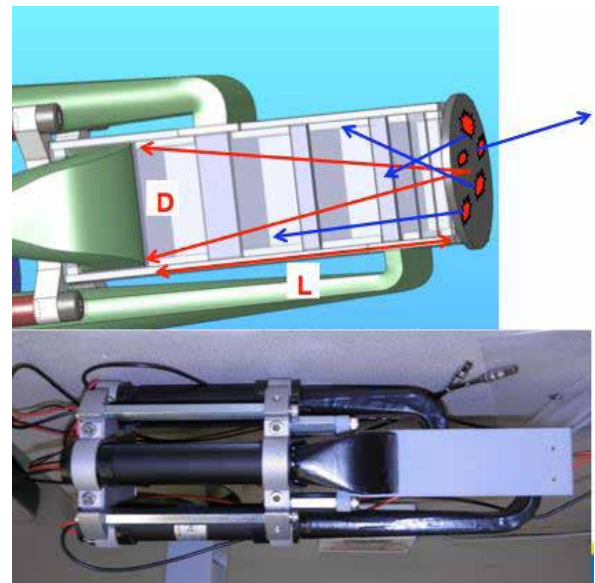

Figure 5. Scintillator telescope for the measurement of fast decaying elements.

References

1. Schwarzkopf, J. D., D. Livescu, R. A. Gore, R. M. Rauen-zahn, and J. R. Ristorcelli. Application of a second-moment closure model to mixing processes involving multicomponent miscible fluids. 2011. *Journal of Turbulence*. 12 (49): 1.
2. Hurricane, O. A., D. A. Callahan, D. T. Casey, E. L. Dewald, T. R. Dittrich, Doepfner, M. A. B. Garcia, D. E. Hinkel, L. F. B. Hopkins, Kervin, J. L. Kline, Le Pape, Ma, A. G. MacPhee, J. L. Milovich, Moody, A. E. Pak, P. K. Patel, H. - . Park, B. A. Remington, H. F. Robey, J. D. Salmonson, P. T. Springer, Tommasini, L. R. Benedetti, J. A. Caggiano, Celliers, Cerjan, Dylla-Spears, Edgell, M. J. Edwards, Fittinghoff, G. P. Grim, Guler, Izumi, J. A. Frenje, M. G. Johnson, Haan, Hatarik, Herrmann, Khan, Knauer, B. J. Kozioziemski, A. L. Kritcher, Kyrala, S. A. Maclaren, F. E. Merrill, Michel, Ralph, J. S. Ross, J. R. Rygg, M. B. Schneider, B. K. Spears, Widmann, and C. B. Yeamans. The high-foot implosion campaign on the National Ignition Facility. 2014. *PHYSICS OF PLASMAS*. 21 (5).
3. Kim, Y. H., H. W. Herrmann, T. Hilsabeck, K. Moy, W. Stoeffl, J. M. Mack, C. S. Young, W. Wu, D. B. Barlow, J. B. Schillig, J. R. Sims Jr., F. E. Lopez, D. Mares, and A. C. Hayes-Sterbenz. Gamma Compton spectrometer: An energy-resolved gamma-ray diagnostic for National Ignition Facility. 2012. LA-UR-12-21134. Paper submitted to 19th Topical Conference High-Temperature Plasma Diagnostics ; 2012-05-07 ; Montrey, California, United States .
4. Kline, J. L., G. P. Grim, J. R. Fincke, R. A. Gore, A. C. Hayes, G. Jungman, C. M. Snell, and M. J. Steinkamp. Prompt radiochemistry in HED experiments. 2011. LA-UR-11-03871; Submitted to JOWOG-37 ; Aldermaston, UK ; July 11, 2011.
5. Kline, J. L., G. P. Grim, J. R. Fincke, R. A. Gore, A. C. Hayes, G. Jungman, F. E. Merrill, C. M. Snell, and M. J. Steinkamp. Neutron imaging in HED experiments. 2011. LA-UR-11-03862; Submitted to JOWOG-37 ; Aldermaston, UK ; July 11, 2011.
6. Mackinnon, A. J., J. L. Kline, S. N. Dixit, S. H. Glenzer, M. J. Edwards, D. A. Callahan, N. B. Meezan, S. W. Haan, J. D. Kilkenny, Doepfner, D. R. Farley, J. D. Moody, J. E. Ralph, B. J. MacGowan, O. L. Landen, H. F. Robey, T. R. Boehly, P. M. Celliers, J. H. Eggert, Krauter, Frieders, G. F. Ross, D. G. Hicks, R. E. Olson, S. V. Weber, B. K. Spears, J. D. Salmonsen, Michel, Divol, Hammel, C. A. Thomas, D. S. Clark, O. S. Jones, P. T. Springer, C. J. Cerjan, G. W. Collins, V. Y. Glebov, J. P. Knauer, Sangster, Stoeckl, McKenty, J. M. McNaney, R. J. Leeper, C. L. Ruiz, G. W. Cooper, A. G. Nelson, G. G. A. Chandler, K. D. Hahn, M. J. Moran, M. B. Schneider, N. E. Palmer, R. M. Bionta, E. P. Hartouni, LePape, P. K. Patel, Izumi, Tommasini, E. J. Bond, J. A. Caggiano, Hatarik, G. P. Grim, F. E. Merrill, D. N. Fittinghoff, Guler, Drury, D. C. Wilson, H. W. Herrmann, Stoeffl, D. T. Casey, M. G. Johnson, J. A. Frenje, R. D. Petrasso, Zylestra, Rinderknecht, D. H. Kalantar, J. M. Dzenitis, Di Nicola, D. C. Eder, W. H. Courdin, Gururangan, S. C. Burkhart, Friedrich, D. L. Blueuel, L. A. Bernstein, M. J. Eckart, D. H. Munro, S. P. Hatchett, A. G. Macphee, D. H. Edgell, D. K. Bradley, P. M. Bell, S. M. Glenn, Simanovskaia, M. A. Barrios, Benedetti, G. A. Kyrala, R. P. J. Town, E. L. Dewald, J. L. Milovich, Widmann, A. S. Moore, LaCaille, S. P. Regan, L. J. Suter, Felker, R. C. Ashabranner, M. C. Jackson, Prasad, M. J. Richardson, T. R. Kohut, P. S. Datte, G. W. Krauter, J. J. Klingman, R. F. Burr, T. A. Land, M. R. Hermann, D. A. Latray, R. L. Saunders, Weaver, S. J. Cohen, Berzins, S. G. Brass, E. S. Palma, R. R. Lowe-Webb, G. N. McHalle, P. A. Arnold, L. J. Lagin, C. D. Marshall, G. K. Brunton, D. G. Mathisen, R. D. Wood, J. R. Cox, R. B. Ehrlich, K. M. Knittel, M. W. Bowers, R. A. Zacharias, B. K. Young, J. P. Holder, J. R. Kimbrough, Ma, K. N. La Fortune, C. C. Widmayer, M. J. Shaw, G. V. Erbert, K. S. Jancaitis, J. M. DiNicola, Orth, Heestand, Kirkwood, Haynam, P. J. Wegner, P. K. Whitman, Hamza, E. G. Dzenitis, R. J. Wallace, S. D. Bhandarkar, T. G. Parham, Dylla-Spears, E. R. Mapoles, B. J. Kozioziemski, J. D. Sater, C. F. Walters, B. J. Haid, Fair, Nikroo, Giraldez, Moreno, Vanwonterghem, R. L. Kauffman, Batha, D. W. Larson, R. J. Fortner, D. H. Schneider, J. D. Lindl, R. W. Patterson, L. J. Atherton, and E. I. Moses. Assembly of High-Areal-Density Deuterium-Tritium Fuel from Indirectly Driven Cryogenic Implosions. 2012. *PHYSICAL REVIEW LETTERS*. 108 (21).
7. Montgomery, D. S., N. Guler, K. A. Flippo, J. L. Kline, R. G. Watt, J. R. Fincke, G. P. Grim, B. J. Albright, A. C. Hayes-Sterbenz, L. W. Sherrill, R. Kirkpatrick, and P. Amendt. Indirect drive double shells as an alternative ignition design. 2014. LA-CP-14-00275.
8. Paris, M. W., L. S. Brown, G. M. Hale, A. C. Hayes-Sterbenz, Jungman, Kawano, G. M. Fuller, E. B. Grohs, and Kunieda. Toward a self-consistent and unitary reaction network for bigbang nucleosynthesis. 2014. CNR*13 - FOURTH INTERNATIONAL WORKSHOP ON COMPOUND NUCLEAR REACTIONS AND RELATED TOPICS. 69.
9. Paris, M., Hale, Hayes-Sterbenz, and Jungman. R-matrix Analysis of Reactions in the B-9 Compound System. 2014. *NUCLEAR DATA SHEETS*. 120: 184.

10. Hayes-Sterbenz, A. C.. Radiochemistry and RIF neutron studies at NIF. 2014. LA-UR-14-22081.
11. Hayes-Sterbenz, A. C., G. Jungman, A. Schulz, M. Boswell, M. M. Fowler, G. P. Grim, A. Klein, R. S. Rundberg, J. B. Wilhelmy, D. C. Wilson, C. Cerjan, D. Schneider, A. Tonchev, and C. Yeamans. Reaction-in-Flight neutrons as a test of stopping power in degenerate plasmas. 2014. LA-UR-14-29105; Full paper submitted to Physics of Plasmas.
12. Casey, D. T., V. A. Smalyuk, R. E. Tipton, J. E. Pino, G. P. Grim, B. A. Remington, D. P. Rowley, S. V. Weber, Barrios, L. R. Benedetti, D. L. Bleuel, E. J. Bond, D. K. Bradley, J. A. Caggiano, D. A. Callahan, C. J. Cerjan, K. C. Chen, D. H. Edgell, M. J. Edwards, Fittinghoff, J. A. Frenje, Gatu-Johnson, V. Y. Glebov, Glenn, Guler, S. W. Haan, Hamza, Hatarik, H. W. Herrmann, Hoover, W. W. Hsing, Izumi, Kervin, Khan, J. D. Kilkenny, Kline, Knauer, Kyrala, O. L. Landen, Ma, A. G. MacPhee, J. M. McNaney, Mintz, Moore, Nikroo, Pak, Parham, Petrasso, H. G. Rinderknecht, D. B. Sayre, Schneider, Stoeffl, Tommasini, R. P. Town, Widmann, D. C. Wilson, and C. B. Yeamans. Development of the CD Symcap platform to study gas-shell mix in implosions at the National Ignition Facility. 2014. PHYSICS OF PLASMAS. 21 (9).
13. Sayre, D. B., C. R. Brune, J. A. Caggiano, V. Y. Glebov, Hatarik, A. D. Bacher, D. L. Bleuel, D. T. Casey, C. J. Cerjan, M. J. Eckart, R. J. Fortner, J. A. Frenje, Friedrich, Gatu-Johnson, G. P. Grim, Hagmann, J. P. Knauer, J. L. Kline, D. P. McNabb, J. M. McNaney, J. M. Mintz, M. J. Moran, Nikroo, Phillips, J. E. Pino, B. A. Remington, D. P. Rowley, D. H. Schneider, V. A. Smalyuk, Stoeffl, R. E. Tipton, S. V. Weber, and C. B. Yeamans. Measurement of the T plus T Neutron Spectrum Using the National Ignition Facility. 2013. PHYSICAL REVIEW LETTERS. 111 (5).
14. Smalyuk, V. A., R. E. Tipton, J. E. Pino, D. T. Casey, G. P. Grim, B. A. Remington, D. P. Rowley, S. V. Weber, Barrios, L. R. Benedetti, D. L. Bleuel, D. K. Bradley, J. A. Caggiano, D. A. Callahan, C. J. Cerjan, D. S. Clark, D. H. Edgell, M. J. Edwards, J. A. Frenje, Gatu-Johnson, V. Y. Glebov, Glenn, S. W. Haan, Hamza, Hatarik, W. W. Hsing, Izumi, Khan, J. D. Kilkenny, Kline, Knauer, O. L. Landen, Ma, J. M. McNaney, Mintz, Moore, Nikroo, Pak, Parham, Petrasso, D. B. Sayre, M. B. Schneider, Tommasini, R. P. Town, Widmann, D. C. Wilson, and C. B. Yeamans. Measurements of an Ablator-Gas Atomic Mix in Indirectly Driven Implosions at the National Ignition Facility. 2014. PHYSICAL REVIEW LETTERS. 112 (2).
15. Fittinghoff, D. N., D. P. Atkinson, D. E. Bower, O. B. Drury, J. M. Dzenitis, Felker, Frank, S. N. Liddick, M. J. Moran, G. P. Roberson, P. B. Weiss, G. P. Grim, R. J. Aragonez, T. N. Archuleta, S. H. Batha, D. D. Clark, D. J. Clark, C. R. Danly, R. D. Day, V. E. Fatherley, J. P. Finch, F. P. Garcia, R. A. Gallegos, Guler, A. H. Hsu, S. A. Jaramillo, E. N. Loomis, Mares, D. D. Martinson, F. E. Merrill, G. L. Morgan, Munson, T. J. Murphy, J. A. Oertel, P. J. Polk, D. W. Schmidt, I. L. Tregillis, A. C. Valdez, P. L. Volegov, T. F. Wang, C. H. Wilde, M. D. Wilke, D. C. Wilson, R. A. Buckles, J. R. Cradick, M. I. Kaufman, S. S. Lutz, R. M. Malone, and Traille. The neutron imaging system fielded at the National Ignition Facility. 2013. Vol. 59.
16. Frenje, J. A., Bionta, E. J. Bond, J. A. Caggiano, D. T. Casey, Cerjan, Edwards, Eckart, D. N. Fittinghoff, Friedrich, V. Y. Glebov, Glenzer, Grim, Haan, Hatarik, Hatchett, M. G. Johnson, O. S. Jones, J. D. Kilkenny, J. P. Knauer, Landen, Leeper, Le Pape, Lerche, C. K. Li, Mackinnon, McNaney, F. E. Merrill, Moran, D. H. Munro, T. J. Murphy, R. D. Petrasso, Rygg, T. C. Sangster, F. H. Seguin, Sepke, Spears, Springer, Stoeckl, and D. C. Wilson. Diagnosing implosion performance at the National Ignition Facility (NIF) by means of neutron spectrometry. 2013. NUCLEAR FUSION. 53 (4).
17. Grim, G. P., G. L. Morgan, Aragonez, T. N. Archuleta, D. E. Bower, C. R. Danly, O. B. Drury, J. M. Dzenitis, V. E. Fatherley, Felker, D. N. Fittinghoff, Guler, F. E. Merrill, J. A. Oertel, C. H. Wilde, and M. D. Wilke. The 27.3 meter neutron time-of-flight system for the National Ignition Facility. 2013. PENETRATING RADIATION SYSTEMS AND APPLICATIONS XIV. 8854.
18. Grim, G. P., Guler, F. E. Merrill, G. L. Morgan, C. R. Danly, P. L. Volegov, C. H. Wilde, D. C. Wilson, D. S. Clark, D. E. Hinkel, O. S. Jones, K. S. Raman, Izumi, D. N. Fittinghoff, O. B. Drury, E. T. Alger, P. A. Arnold, R. C. Ashabranner, L. J. Atherton, M. A. Barrios, Batha, P. M. Bell, L. R. Benedetti, R. L. Berger, L. A. Bernstein, L. V. Berzins, Betti, S. D. Bhandarkar, R. M. Bionta, D. L. Bleuel, T. R. Boehly, E. J. Bond, M. W. Bowers, D. K. Bradley, G. K. Brunton, R. A. Buckles, S. C. Burkhart, R. F. Burr, J. A. Caggiano, D. A. Callahan, D. T. Casey, Castro, P. M. Celliers, C. J. Cerjan, G. A. Chandler, Chocate, S. J. Cohen, G. W. Collins, G. W. Cooper, J. R. Cox, J. R. Cradick, P. S. Datte, E. L. Dewald, Di Nicola, J. M. Di Nicola, Divol, S. N. Dixit, Dylla-Spears, E. G. Dzenitis, M. J. Eckart, D. C. Eder, D. H. Edgell, M. J. Edwards, J. H. Eggert, R. B. Ehrlich, G. V. Erbert, Fair, D. R. Farley, Felker, R. J. Fortner, J. A. Frenje, Frieders, Friedrich, Gatu-Johnson, C. R. Gibson, Giraldez, V. Y. Glebov, S. M. Glenn, S. H. Glenzer, Gururangan, S. W. Haan, K. D. Hahn, B. A. Hammel, A. V. Hamza, E. P. Hartouni, Hatarik, S. P. Hatchett, Haynam, M. R. Hermann, H.

- W. Herrmann, D. G. Hicks, J. P. Holder, D. M. Holunga, J. B. Horner, W. W. Hsing, Huang, M. C. Jackson, K. S. Jancaitis, D. H. Kalantar, R. L. Kauffman, M. I. Kauffman, S. F. Khan, J. D. Kilkenny, J. R. Kimbrough, Kirkwood, J. L. Kline, J. P. Knauer, K. M. Knittel, J. A. Koch, T. R. Kohut, B. J. Kozioziemski, Krauter, G. W. Krauter, A. L. Kritcher, Kroll, G. A. Kyrala, K. N. La Fortune, LaCaille, L. J. Lagin, T. A. Land, O. L. Landen, D. W. Larson, D. A. Latray, R. J. Leeper, T. L. Lewis, LePape, J. D. Lindl, R. R. Lowe-Webb, Ma, B. J. MacGowan, A. J. MacKinnon, A. G. MacPhee, R. M. Malone, T. N. Malsbury, Mapoles, C. D. Marshall, D. G. Mathisen, McKenty, J. M. McNaney, N. B. Meezan, Michel, J. L. Milovich, J. D. Moody, A. S. Moore, M. J. Moran, Moreno, E. I. Moses, D. H. Munro, B. R. Nathan, A. J. Nelson, Nikroo, R. E. Olson, Orth, A. E. Pak, E. S. Palma, T. G. Parham, P. K. Patel, R. W. Patterson, R. D. Petrasso, Prasad, J. E. Ralph, S. P. Regan, Rinderknecht, H. F. Robey, G. F. Ross, C. L. Ruiz, F. H. Seguin, J. D. Salmonson, T. C. Sangster, J. D. Sater, R. L. Saunders, M. B. Schneider, D. H. Schneider, M. J. Shaw, Simanovskaia, B. K. Spears, P. T. Springer, Stoeckl, Stoeffl, L. J. Suter, C. A. Thomas, Tommasini, R. P. Town, A. J. Traille, Van Wonterghem, R. J. Wallace, Weaver, S. V. Weber, P. J. Wegner, P. K. Whitman, Widmann, C. C. Widmayer, R. D. Wood, B. K. Young, R. A. Zacharias, and Zylstra. Nuclear imaging of the fuel assembly in ignition experiments. 2013. PHYSICS OF PLASMAS. 20 (5).
19. Grim, G. P., R. J. Aragonese, D. P. Atkinson, D. P. Atkinson, S. H. Batha, M. A. Barrios, D. E. Bower, D. K. Bradley, R. A. Buckles, D. D. Clark, D. J. Clark, J. R. Cradick, Danly, O. B. Drury, V. E. Fatherley, J. P. Finch, F. P. Garcia, R. A. Gallegos, Guler, S. M. Glenn, A. H. Hsu, Izumi, S. A. Jaramillo, G. A. Kyrala, Le Pape, E. N. Loomis, Mares, D. D. Martinson, Ma, A. J. Mackinnon, F. E. Merrill, G. L. Morgan, Munson, T. J. Murphy, P. J. Polk, D. W. Schmidt, Tommasini, I. L. Tregillis, A. C. Valdez, P. L. Volegov, T. F. Wang, C. H. Wilde, M. D. Wilke, D. C. Wilson, J. M. Dzenitis, Felker, D. N. Fittinghoff, Frank, S. N. Liddick, M. J. Moran, G. P. Roberson, Weiss, M. I. Kauffman, S. S. Lutz, R. M. Malone, and Traille. Summary of the first neutron image data collected at the National Ignition Facility. 2013. Vol. 59.
 20. Grim, G. P., R. S. Rundberg, A. C. Hayes-Sterbenz, G. Jungman, M. Boswell, M. M. Fowler, A. Klein, J. B. Wilhelmy, A. Tonchev, and C. Yeamans. Measurement of reaction-in-flight neutrons using Thulium activation at the National Ignition Facility. 2014. LA-UR-14-27335. Paper submitted to SPIE Optics & Photonics 2014 - Target Diagnostics Physics and Engineering for ICF III Conference, 2014-08-17 (San Diego, California, United States).
 21. Grim, G. P., R. S. Rundberg, A. Tonchev, A. C. Hayes-Sterbenz, G. Jungman, M. Boswell, M. M. Fowler, A. Klein, J. B. Wilhelmy, and C. Yeamans. Search for Reaction-In-Flight neutrons using Thulium activation at the NIF. 2013. LA-UR-13-28581. Presented at 55th Annual Meeting of the APS Division of Plasma Physics ; 2013-11-11; Denver, Colorado, United States.
 22. Guler, , Volegov, C. R. Danly, G. P. Grim, F. E. Merrill, and C. H. Wilde. Simultaneous usage of pinhole and penumbral apertures for imaging small scale neutron sources from inertial confinement fusion experiments. 2012. REVIEW OF SCIENTIFIC INSTRUMENTS. 83 (10).
 23. Rundberg, R. S., M. M. Fowler, G. P. Grim, A. C. Hayes-Sterbenz, K. R. Jackman, G. Jungman, J. B. Wilhelmy, and C. Yeamans. Thulium activation by Reaction-In Flight neutrons. 2014. LA-UR-14-25857. Talk presented at American Chemical Society Meeting..
 24. Rundberg, R. S., R. J. Fortner, M. M. Fowler, J. M. Gostic, G. P. Grim, Jungman, A. C. Hayes, K. J. Moody, D. H. Schneider, D. A. Shaughnessy, and J. B. Wilhelmy. Status of prompt radiochemistry diagnostic development for the National Ignition Facility. 2012. ABSTRACTS OF PAPERS OF THE AMERICAN CHEMICAL SOCIETY. 244.
 25. Volegov, , C. R. Danly, D. N. Fittinghoff, G. P. Grim, Guler, Izumi, Ma, F. E. Merrill, A. L. Warrick, C. H. Wilde, and D. C. Wilson. Neutron source reconstruction from pinhole imaging at National Ignition Facility. 2014. REVIEW OF SCIENTIFIC INSTRUMENTS. 85 (2).
 26. Hayes, A. C.. Radiochemical mix diagnostic in the presence of burn. 2014. LA-UR-14-20490.
 27. Hayes, A. C.. Applications of Nuclear Physics. 2014. Nuclear Physics Town Hall Meeting, Chicago IL, 2014.
 28. Hayes, A. C.. Charged particle radchem and RIF neutrons as probes of mix. 2014. HED Council, LLNL, March 2014.
 29. Hayes, A. C., G. Hale, J. Jungman, G. P. Grim, A. Klein, M. Boswell, C. Wilde, M. Fowler, R. Rundberg, J. Wilhelmy, M. Steinkamp, P. Bradley, C. Snell, T. Clark, R. Singleton, J. Fincke, R. Gore, D. Shaughnessy, K. Moody, L. Bernstein, D. Fortner, D. Schneider, and C. Cerjan. Nuclear-plasma physics studies using radiochemistry at NIF. 2012. LA-UR-12-01105: Presented at Nuclear Data Workshop ; Los Alamos, NM ; March 6, 2012.
 30. Gore, R. A.. Report on L2 TN Burn in Heterogeneous

- Mixtures (U). 2013. LA-CP-13-00435; Briefing at DOE Headquarters ; Washington, DC ; May 2, 2013.
31. Gore, R. A.. Primary mix and burn update (U). 2014. LA-CP-14-00754; Presented at JOWOG 32P ; June 2, 2014 ; Los Alamos, NM.
 32. Gore, R. A.. A new model applied to the secondary validation suite (U). 2014. LA-CP-14-00753; Presented at JOWOG 32S ; Los Alamos, NM ; June 17, 2014.
 33. Stalsberg, K. L., R. A. Gore, C. M. Snell, and J. M. Campbell. Application of New Models Towards Understanding Mix and Burn in UGT's (U). 2013. LA-CP-13-01350; Talk presented at NEDPC 2013 ; Livermore, CA ; October 14, 2013.
 34. Stalsberg, K., R. A. Gore, J. Fincke, and J. Schwarzkopf. Application of New Mix and Burn Models in an ASC Code (U). 2013. LA-CP-13-00531; Presented at JOWOG 32 ; AWE, Aldermaston, UK ; June 3, 2013.
 35. Steinkamp, M. J., R. A. Gore, G. P. Grim, A. C. Hayes, and G. Jungman. Leveraging the national ignition facility (NIF) to better understand turbulence in support of US nuclear stockpile stewardship. 2011. LA-UR-11-02992: LDRD Poster.
 36. Steinkamp, M. J., R. A. Gore, G. P. Grim, G. Jungman, M. Boswell, J. R. Fincke, A. C. Hayes-Sterbenz, and A. Klein. Using the National Ignition Facility (NIF) in Livermore CA to better understand materials mixing(U). 2012. LA-UR-12-24886: Poster presented at LDRD-Days ; 2012-10-23 - 2012-10-23 ; Santa Fe, New Mexico, United States.
 37. Grim, G. P., R. S. Rundberg, A. C. Hayes-Sterbenz, G. Jungman, M. Boswell, M. M. Fowler, A. Klein, J. B. Wilhelm, A. Tonchev, and C. Yeaman. Measurement of reaction-in-flight neutrons using Thulium activation at the NIF. 2014. LA-UR-14-21355.
 38. Smalyuk, V. A., Barrios, J. A. Caggiano, D. T. Casey, C. J. Cerjan, D. S. Clark, M. J. Edwards, J. A. Frenje, Gatu-Johnson, V. Y. Glebov, Grim, S. W. Haan, B. A. Hammel, Hamza, D. E. Hoover, W. W. Hsing, Hurricane, J. D. Kilkenny, J. L. Kline, J. P. Knauer, Kroll, O. L. Landen, J. D. Lindl, Ma, J. M. McNaney, Mintz, Moore, Nikroo, Parham, J. L. Peterson, Petrasso, Pickworth, J. E. Pino, Raman, S. P. Regan, B. A. Remington, H. F. Robey, D. P. Rowley, D. B. Sayre, R. E. Tipton, S. V. Weber, Widmann, D. C. Wilson, and C. B. Yeaman. Hydrodynamic instability growth and mix experiments at the National Ignition Facility. 2014. PHYSICS OF PLASMAS. 21 (5).
 39. Miranek, M. M., G. D. Kerbel, N. A. Gentile, O. Jones, and D. Munro. Three-dimensional HYDRA simulations at National Ignition Facility targets. 2001. Physics of Plasmas. 8 (5): 2275.
 40. MAYNARD, G., and C. DEUTSCH. BORN RANDOM PHASE APPROXIMATION FOR ION STOPPING IN AN ARBITRARILY DEGENERATE ELECTRON FLUID. 1985. JOURNAL DE PHYSIQUE. 46 (7): 1113.
 41. Grabowski, P. E., M. P. Surh, D. F. Richards, F. R. Graziani, and M. S. Murillo. Molecular Dynamics Simulations of Classical Stopping Power. 2013. PHYSICAL REVIEW LETTERS. 111 (21).
 42. Zimmerman, G. B.. Recent developments in Monte Carlo techniques. 1990. Livermore National Laboratory report, UCRL-JC-105616.
 43. Grim, G. P., N. Guler, F. E. Merrill, G. L. Morgan, C. R. Danly, P. L. Volegov, C. H. Wilde, D. C. Wilson, D. Hinkle, O. Jones, K. Raman, N. Izumi, D. Fittinghoff, O. Drury, and D. Clark. Nuclear imaging of the fuel assembly in ignition experiments. 2013. LA-UR-13-21677; Full paper presented at 54th Annual Meeting of the APS Division of Plasma Physics ; 2012-10-28 - 2012-11-02 ; Providence, Rhode Island, United States .
 44. Allison, J., K. Amako, J. Apostolakis, H. Araujo, P. A. Dubois, M. Asai, G. Barrant, R. Capra, S. Chauvie, R. Chytrac, G. A. P. Cirrone, G. Cooperman, G. Cosmo, G. Cuttone, G. G. Daquino, M. Donszelmann, M. Dreschel, G. Folger, F. Foppiano, J. Generowicz, V. Grichine, S. Guatelli, P. Gumplinger, A. Heikkinen, I. Hrivnacova, A. Howard, S. Incerti, V. Ivanchenko, T. Johnson, F. Jones, T. Koi, R. Kokoulin, M. Kossov, H. Kurashige, V. Lara, S. Larsson, F. Lei, O. Link, F. Longo, M. Maire, A. Mantero, B. Mascialino, I. McLaren, P. M. Lorenzo, K. Minamimoto, K. Murakami, P. Nieminen, L. Pandola, S. Parlati, L. Peralta, J. Perl, A. Pfeiffer, M. G. Pia, A. Ribon, P. Rodrigues, G. Russo, S. Sadilov, G. Santin, T. Sasaki, D. Smith, N. Starkov, S. Tanaka, E. Tcherniaev, B. Tome, A. Trindade, P. Truscott, L. Urban, M. Verderi, A. Walkden, J. P. Wellisch, D. C. Williams, D. Wright, and H. Yoshida. Geant4 developments and applications. 2006. IEEE TRANSACTIONS ON NUCLEAR SCIENCE. 53 (1): 270.
 45. Campbell, J. M., C. M. Snell, K. L. Stalsberg, D. K. Parsons, R. A. Gore, and M. B. Lee. Calculation of Titanium/Vanadium charged-particle radiochemistry (U). 2013. LA-CP-13-01199; Poster presented at NEDPC 2013 ; October 14, 2013 ; Livermore, CA, USA.
 46. Campbell, J. M., C. M. Snell, K. L. Stalsberg, R. A. Gore, D. K. Parsons, and M. B. Lee. Calculation of Titanium/

Vanadium charged particle radiochemistry (U). 2014. LA-CP-14-00374. Full paper submitted to Nuclear Explosives Design Physics Conference NEDPC 2013 ; March 10, 2014 ; Livermore, CA.

47. Snell, C. M.. General method for charged particle radiochemistry in a code (U). 2014. LA-CP-14-01122. Poster presented at Nuclear Explosives Code Development Conference (NECDC) 2014 ; Los Alamos, NM ; October 20, 2014 .
48. Snell, C. M., K. Stalsberg, J. M. Campbell, M. B. Lee, R. A. Gore, B. M. Haines, and K. Parsons. General method for charged-particle transport with isotope mix partition and coupled radiochemistry in a code (U). 2014. LA-CP-15-00075; paper submitted to Nuclear Explosives Code Developers Conference (NECDC), Los Alamos, NM, Oct. 2014.
49. Grim, G. P., P. A. Bradley, T. A. Bredeweg, A. L. Keksis, M. M. Fowler, A. C. Hayes, Jungman, A. W. Obst, R. S. Rundberg, D. J. Vieira, J. B. Wilhelmy, L. A. Bernstein, C. J. Cerjan, R. J. Fortner, K. J. Moody, D. H. Schneider, D. A. Shaughnessy, Stoeffl, and M. A. Stoyer. Prompt radiochemistry at the National Ignition Facility (invited). 2008. REVIEW OF SCIENTIFIC INSTRUMENTS. 79 (10).
50. Douglas, M. R.. Marble brief overview . 2014. LA-UR-14-26602.

Publications

- Bradley, P. A., G. P. Grim, A. C. Hayes, Jungman, R. S. Rundberg, J. B. Wilhelmy, G. M. Hale, and R. C. Korzekwa. Neutron reactions in the hohlraum at the LLNL National Ignition Facility. 2012. PHYSICAL REVIEW C. 86 (1).
- Campbell, J. M., C. M. Snell, K. L. Stalsberg, D. K. Parsons, R. A. Gore, and M. B. Lee. Calculation of Titanium/Vanadium charged-particle radiochemistry (U). 2013. LA-CP-13-01199; Poster presented at NEDPC 2013 ; October 14, 2013 ; Livermore, CA, USA.
- Campbell, J. M., C. M. Snell, K. L. Stalsberg, R. A. Gore, D. K. Parsons, and M. B. Lee. Calculation of Titanium/Vanadium charged particle radiochemistry (U). 2014. LA-CP-14-00374. Full paper submitted to Nuclear Explosives Design Physics Conference NEDPC 2013 ; March 10, 2014 ; Livermore, CA.
- Casey, D. T., V. A. Smalyuk, R. E. Tipton, J. E. Pino, G. P. Grim, B. A. Remington, D. P. Rowley, S. V. Weber, Barrios, L. R. Benedetti, D. L. Bleuel, E. J. Bond, D. K. Bradley, J. A. Caggiano, D. A. Callahan, C. J. Cerjan, K. C. Chen, D. H. Edgell, M. J. Edwards, Fittinghoff, J. A. Frenje, Gatu-Johnson, V. Y. Glebov, Glenn, Guler, S. W. Haan, Hamza, Hatarik, H. W. Herrmann, Hoover, W. W. Hsing, Izumi, Kervin, Khan, J. D. Kilkenney, Kline, Knauer, Kyrala, O. L. Landen, Ma, A. G. MacPhee, J. M. McNaney, Mintz, Moore, Nikroo, Pak, Parham, Petrasso, H. G. Rinderknecht, D. B. Sayre, Schneider, Stoeffl, Tomasini, R. P. Town, Widmann, D. C. Wilson, and C. B. Yeaman. Development of the CD Symcap platform to study gas-shell mix in implosions at the National Ignition Facility. 2014. PHYSICS OF PLASMAS. 21 (9).
- Chrien, R. E., B. Cheng, C. R. Hagelberg, R. S. Baty, J. C. Pedicini, B. J. Reardon, D. F. Jablonski, J. D. Schwarzkopf, M. J. Andrews, W. T. Butler, R. K. Schulze, D. G. Sheppard, R. A. Gore, J. A. Guzik, J. J. Vandenberg, M. R. Tamashiro, W. C. Inkret, J. A. Musgrave, C. C. Joggerst, G. R. Maskaly, and J. R. Jenkins. Weapons Review Letters, Issue 4 (U). 2014. LA-CP-14-01046; Published in Weapons Review Letters.
- Fastje, , H. B. Barber, Bora, Lemieux, Miller, and G. P. Grim. PRELIMINARY INVESTIGATION OF THE NON-LINEAR RESPONSE OF IMAGE INTENSIFIERS USED FOR GAMMA-RAY IMAGING. 2013. PENETRATING RADIATION SYSTEMS AND APPLICATIONS XIV. 8854.
- Fittinghoff, D. N., D. P. Atkinson, D. E. Bower, O. B. Drury, J. M. Dzenitis, Felker, Frank, S. N. Liddick, M. J. Moran, G. P. Roberson, P. B. Weiss, G. P. Grim, R. J. Aragonz, T. N. Archuleta, S. H. Batha, D. D. Clark, D. J. Clark, C. R. Danly, R. D. Day, V. E. Fatherley, J. P. Finch, F. P. Garcia, R. A. Gallegos, Guler, A. H. Hsu, S. A. Jaramillo, E. N. Loomis, Mares, D. D. Martinson, F. E. Merrill, G. L. Morgan, Munson, T. J. Murphy, J. A. Oertel, P. J. Polk, D. W. Schmidt, I. L. Tregillis, A. C. Valdez, P. L. Volegov, T. F. Wang, C. H. Wilde, M. D. Wilke, D. C. Wilson, R. A. Buckles, J. R. Cradick, M. I. Kaufman, S. S. Lutz, R. M. Malone, and Traille. The neutron imaging system fielded at the National Ignition Facility. 2013. In IFSA 2011 - SEVENTH INTERNATIONAL CONFERENCE ON INERTIAL FUSION SCIENCES AND APPLICATIONS. Vol. 59.
- Frenje, J. A., Bionta, E. J. Bond, J. A. Caggiano, D. T. Casey, Cerjan, Edwards, Eckart, D. N. Fittinghoff, Friedrich, V. Y. Glebov, Glenzer, Grim, Haan, Hatarik, Hatchett, M. G. Johnson, O. S. Jones, J. D. Kilkenney, J. P. Knauer, Landen, Leeper, Le Pape, Lerche, C. K. Li, Mackinnon, McNaney, F. E. Merrill, Moran, D. H. Munro, T. J. Murphy, R. D. Petrasso, Rygg, T. C. Sangster, F. H. Seguin, Sepke, Spears, Springer, Stoeckl, and D. C. Wilson. Diagnosing implosion performance at the National Ignition Facility (NIF) by means of neutron spectrometry. 2013. NUCLEAR FUSION. 53 (4).
- Gore, R. A.. Report on L2 TN Burn in Heterogeneous Mixtures (U). 2013. LA-CP-13-00435; Briefing at DOE Headquarters ; Washington, DC ; May 2, 2013.
- Gore, R. A.. Primary mix and burn update (U). 2014. LA-CP-14-00754; Presented at JOWOG 32P ; June 2, 2014 ; Los Alamos, NM.

- Gore, R. A.. A new model applied to the secondary validation suite (U). 2014. LA-CP-14-00753; Presented at JO-WOG 32S ; Los Alamos, NM ; June 17, 2014.
- Gore, R. A., J. M. Scott, R. J. Kanzleiter, K. L. Stalsberg, L. Welser-Sherrill, R. Carver, G. R. Maskaly, C. L. Rousculp, D. M. Israel, D. Livescu, L. A. Collins, J. D. Kress, J. R. Fincke, B. R. Peterson, R. C. Shah, J. F. Benage, and D. F. Jablonski. Experimental Campaigns for Primary Boost (U). 2013. LA-CP-13-01139; Completion Documentation for DSW Level 2 Milestone.
- Gore, R. A., K. C. N. Scott, J. R. Fincke, F. W. Doss, M. A. Gunderson, A. L. Hungerford, D. Livescu, A. M. Schwendt, J. M. Scott, K. L. Stalsber-Zarling, R. P. Weaver, and L. Welser-Sherrill. Assessment of the performance modeling capability of an ASC code (U). 2012. LA-CP-12-01215: Full paper submitted to Defense Research Review (DRR).
- Grim, G. P., G. L. Morgan, Aragonez, T. N. Archuleta, D. E. Bower, C. R. Danly, O. B. Drury, J. M. Dzenitis, V. E. Fatherley, Felker, D. N. Fittinghoff, Guler, F. E. Merrill, J. A. Oertel, C. H. Wilde, and M. D. Wilke. The 27.3 meter neutron time-of-flight system for the National Ignition Facility. 2013. PENETRATING RADIATION SYSTEMS AND APPLICATIONS XIV. 8854.
- Grim, G. P., Guler, F. E. Merrill, G. L. Morgan, C. R. Danly, P. L. Volegov, C. H. Wilde, D. C. Wilson, D. S. Clark, D. E. Hinkel, O. S. Jones, K. S. Raman, Izumi, D. N. Fittinghoff, O. B. Drury, E. T. Alger, P. A. Arnold, R. C. Ashabraner, L. J. Atherton, M. A. Barrios, Batha, P. M. Bell, L. R. Benedetti, R. L. Berger, L. A. Bernstein, L. V. Berzins, Betti, S. D. Bhandarkar, R. M. Bionta, D. L. Bleuel, T. R. Boehly, E. J. Bond, M. W. Bowers, D. K. Bradley, G. K. Brunton, R. A. Buckles, S. C. Burkhart, R. F. Burr, J. A. Caggiano, D. A. Callahan, D. T. Casey, Castro, P. M. Celliers, C. J. Cerjan, G. A. Chandler, Choate, S. J. Cohen, G. W. Collins, G. W. Cooper, J. R. Cox, J. R. Cradick, P. S. Datte, E. L. Dewald, Di Nicola, J. M. Di Nicola, Divol, S. N. Dixit, Dylla-Spears, E. G. Dzenitis, M. J. Eckart, D. C. Eder, D. H. Edgell, M. J. Edwards, J. H. Eggert, R. B. Ehrlich, G. V. Erbert, Fair, D. R. Farley, Felker, R. J. Fortner, J. A. Frenje, Frieders, Friedrich, Gatu-Johnson, C. R. Gibson, Giraldez, V. Y. Glebov, S. M. Glenn, S. H. Glenzer, Gururangan, S. W. Haan, K. D. Hahn, B. A. Hammel, A. V. Hamza, E. P. Hartouni, Hatarik, S. P. Hatchett, Haynam, M. R. Hermann, H. W. Herrmann, D. G. Hicks, J. P. Holder, D. M. Holunga, J. B. Horner, W. W. Hsing, Huang, M. C. Jackson, K. S. Jancaitis, D. H. Kalantar, R. L. Kauffman, M. I. Kauffman, S. F. Khan, J. D. Kilkenny, J. R. Kimbrough, Kirkwood, J. L. Kline, J. P. Knauer, K. M. Knittel, J. A. Koch, T. R. Kohut, B. J. Koziolowski, Krauter, G. W. Krauter, A. L. Kritcher, Kroll, G. A. Kyrala, K. N. La Fortune, LaCaille, L. J. Lagin, T. A. Land, O. L. Landen, D. W. Larson, D. A. Latray, R. J. Leeper, T. L. Lewis, LePape, J. D. Lindl, R. R. Lowe-Webb, Ma, B. J. MacGowan, A. J. MacKinnon, A. G. MacPhee, R. M. Malone, T. N. Malsbury, Mapoles, C. D. Marshall, D. G. Mathisen, McKenty, J. M. McNaney, N. B. Meezan, Michel, J. L. Milovich, J. D. Moody, A. S. Moore, M. J. Moran, Moreno, E. I. Moses, D. H. Munro, B. R. Nathan, A. J. Nelson, Nikroo, R. E. Olson, Orth, A. E. Pak, E. S. Palma, T. G. Parham, P. K. Patel, R. W. Patterson, R. D. Petrasso, Prasad, J. E. Ralph, S. P. Regan, Rinderknecht, H. F. Robey, G. F. Ross, C. L. Ruiz, F. H. Seguin, J. D. Salmonson, T. C. Sangster, J. D. Sater, R. L. Saunders, M. B. Schneider, D. H. Schneider, M. J. Shaw, Simanovskaia, B. K. Spears, P. T. Springer, Stoeckl, Stoeffl, L. J. Suter, C. A. Thomas, Tommasini, R. P. Town, A. J. Traille, Van Wonterghem, R. J. Wallace, Weaver, S. V. Weber, P. J. Wegner, P. K. Whitman, Widmann, C. C. Widmayer, R. D. Wood, B. K. Young, R. A. Zacharias, and Zylstra. Nuclear imaging of the fuel assembly in ignition experiments. 2013. PHYSICS OF PLASMAS. 20 (5).
- Grim, G. P., R. J. Aragonez, D. P. Atkinson, D. P. Atkinson, S. H. Batha, M. A. Barrios, D. E. Bower, D. K. Bradley, R. A. Buckles, D. D. Clark, D. J. Clark, J. R. Cradick, Danly, O. B. Drury, V. E. Fatherley, J. P. Finch, F. P. Garcia, R. A. Gallegos, Guler, S. M. Glenn, A. H. Hsu, Izumi, S. A. Jaramillo, G. A. Kyrala, Le Pape, E. N. Loomis, Mares, D. D. Martinson, Ma, A. J. Mackinnon, F. E. Merrill, G. L. Morgan, Munson, T. J. Murphy, P. J. Polk, D. W. Schmidt, Tommasini, I. L. Tregillis, A. C. Valdez, P. L. Volegov, T. F. Wang, C. H. Wilde, M. D. Wilke, D. C. Wilson, J. M. Dzenitis, Felker, D. N. Fittinghoff, Frank, S. N. Liddick, M. J. Moran, G. P. Roberson, Weiss, M. I. Kauffman, S. S. Lutz, R. M. Malone, and Traille. Summary of the first neutron image data collected at the National Ignition Facility. 2013. In IFSA 2011 - SEVENTH INTERNATIONAL CONFERENCE ON INERTIAL FUSION SCIENCES AND APPLICATIONS. Vol. 59.
- Grim, G. P., R. S. Rundberg, A. C. Hayes-Sterbenz, G. Jungman, M. Boswell, M. M. Fowler, A. Klein, J. B. Wilhelmy, A. Tonchev, and C. Yeamans. Measurement of reaction-in-flight neutrons using Thulium activation at the NIF. 2014. LA-UR-14-21355.
- Grim, G. P., R. S. Rundberg, A. C. Hayes-Sterbenz, G. Jungman, M. Boswell, M. M. Fowler, A. Klein, J. B. Wilhelmy, A. Tonchev, and C. Yeamans. Measurement of reaction-in-flight neutrons using Thulium activation at the National Ignition Facility. 2014. LA-UR-14-27335. Paper submitted to SPIE Optics & Photonics 2014 - Target Diagnostics Physics and Engineering for ICF III Conference, 2014-08-17 (San Diego, California, United States).
- Grim, G. P., R. S. Rundberg, A. Tonchev, A. C. Hayes-Sterbenz, G. Jungman, M. Boswell, M. M. Fowler, A. Klein, J. B. Wilhelmy, and C. Yeamans. Search for Reaction-In-Flight neutrons using Thulium activation at the NIF. 2013. LA-UR-13-28581. Presented at 55th Annual

- Meeting of the APS Division of Plasma Physics ; 2013-11-11; Denver, Colorado, United States.
- Guler, , Volegov, C. R. Danly, G. P. Grim, F. E. Merrill, and C. H. Wilde. Simultaneous usage of pinhole and penumbral apertures for imaging small scale neutron sources from inertial confinement fusion experiments. 2012. REVIEW OF SCIENTIFIC INSTRUMENTS. 83 (10).
- Hayes, . High energy density physics from radiochemistry at the National Ignition Facility. 2012. ABSTRACTS OF PAPERS OF THE AMERICAN CHEMICAL SOCIETY. 244.
- Hayes, A. C.. On neutron-neutron scattering in a DT plasma. LA-UR-13-26168.
- Hayes, A. C.. Radiochemical mix diagnostic in the presence of burn. 2014. LA-UR-14-20490.
- Hayes, A. C.. Applications of Nuclear Physics. 2014. Nuclear Physics Town Hall Meeting, Chicago IL, 2014.
- Hayes, A. C.. Charged particle radchem and RIF neutrons as probes of mix. 2014. HED Council, LLNL, March 2014.
- Hayes, A. C., G. Hale, J. Jungman, G. P. Grim, A. Klein, M. Boswell, C. Wilde, M. Fowler, R. Rundberg, J. Wilhelmy, M. Steinkamp, P. Bradley, C. Snell, T. Clark, R. Singleton, J. Fincke, R. Gore, D. Shaughnessy, K. Moody, L. Bernstein, D. Fortner, D. Schneider, and C. Cerjan. Nuclear-plasma physics studies using radiochemistry at NIF. 2012. LA-UR-12-01105: Presented at Nuclear Data Workshop ; Los Alamos, NM ; March 6, 2012.
- Hayes-Sterbenz, A. C.. Radiochemistry and RIF neutron studies at NIF. 2014. LA-UR-14-22081.
- Hayes-Sterbenz, A. C., G. Jungman, A. Schulz, M. Boswell, M. M. Fowler, G. P. Grim, A. Klein, R. S. Rundberg, J. B. Wilhelmy, D. C. Wilson, C. Cerjan, D. Schneider, A. Tonchev, and C. Yeamans. Reaction-in-Flight neutrons as a test of stopping power in degenerate plasmas. 2014. LA-UR-14-29105; Full paper submitted to Physics of Plasmas.
- Hayes-Sterbenz, A. C., G. Jungman, M. Boswell, M. M. Fowler, G. P. Grim, A. Klein, R. S. Rundberg, J. B. Wilhelmy, D. C. Wilson, C. Cerjan, D. Schneider, A. Tonchev, and C. Yeamans. Reaction-in-Flight neutrons and the stopping power in cryogenic NIF capsules. 2014. LA-UR-14-29017. Invited Talk at 56th Annual Meeting of the APS Division of Plasma Physics, 2014-10-27 (New Orleans, Louisiana, United States).
- Hurricane, O. A., D. A. Callahan, D. T. Casey, E. L. Dewald, T. R. Dittrich, Doepfner, M. A. B. Garcia, D. E. Hinkel, L. F. B. Hopkins, Kervin, J. L. Kline, Le Pape, Ma, A. G. MacPhee, J. L. Milovich, Moody, A. E. Pak, P. K. Patel, H. -. Park, B. A. Remington, H. F. Robey, J. D. Salmonson, P. T. Springer, Tommasini, L. R. Benedetti, J. A. Caggiano, Celliers, Cerjan, Dylla-Spears, Edgell, M. J. Edwards, Fittinghoff, G. P. Grim, Guler, Izumi, J. A. Frenje, M. G. Johnson, Haan, Hatarik, Herrmann, Khan, Knauer, B. J. Koziowski, A. L. Kritcher, Kyrala, S. A. Maclaren, F. E. Merrill, Michel, Ralph, J. S. Ross, J. R. Rygg, M. B. Schneider, B. K. Spears, Widmann, and C. B. Yeamans. The high-foot implosion campaign on the National Ignition Facility. 2014. PHYSICS OF PLASMAS. 21 (5).
- Kim, , H. W. Herrmann, T. J. Hilsabeck, Moy, Stoeffl, J. M. Mack, C. S. Young, Wu, D. B. Barlow, J. B. Schillig, J. R. Sims Jr., F. E. Lopez, Mares, J. A. Oertel, and A. C. Hayes-Sterbenz. Gamma-to-electron magnetic spectrometer (GEMS): An energy-resolved gamma-ray diagnostic for the National Ignition Facility. 2012. REVIEW OF SCIENTIFIC INSTRUMENTS. 83 (10).
- Kim, Y. H., H. W. Herrmann, T. Hilsabeck, K. Moy, W. Stoeffl, J. M. Mack, C. S. Young, W. Wu, D. B. Barlow, J. B. Schillig, J. R. Sims Jr., F. E. Lopez, D. Mares, and A. C. Hayes-Sterbenz. Gamma Compton spectrometer: An energy-resolved gamma-ray diagnostic for National Ignition Facility. 2012. LA-UR-12-21134. Paper submitted to 19th Topical Conference High-Temperature Plasma Diagnostics ; 2012-05-07 ; Montrey, California, United States .
- Kline, J. L., G. P. Grim, J. R. Fincke, R. A. Gore, A. C. Hayes, G. Jungman, C. M. Snell, and M. J. Steinkamp. Prompt radiochemistry in HED experiments. 2011. LA-UR-11-03871; Submitted to JOWOG-37 ; Aldermaston, UK ; July 11, 2011.
- Kline, J. L., G. P. Grim, J. R. Fincke, R. A. Gore, A. C. Hayes, G. Jungman, F. E. Merrill, C. M. Snell, and M. J. Steinkamp. Neutron imaging in HED experiments. 2011. LA-UR-11-03862; Submitted to JOWOG-37 ; Aldermaston, UK ; July 11, 2011.
- Mackinnon, A. J., J. L. Kline, S. N. Dixit, S. H. Glenzer, M. J. Edwards, D. A. Callahan, N. B. Meezan, S. W. Haan, J. D. Kilkenney, Doepfner, D. R. Farley, J. D. Moody, J. E. Ralph, B. J. MacGowan, O. L. Landen, H. F. Robey, T. R. Boehly, P. M. Celliers, J. H. Eggert, Krauter, Frieders, G. F. Ross, D. G. Hicks, R. E. Olson, S. V. Weber, B. K. Spears, J. D. Salmonsens, Michel, Divol, Hammel, C. A. Thomas, D. S. Clark, O. S. Jones, P. T. Springer, C. J. Cerjan, G. W. Collins, V. Y. Glebov, J. P. Knauer, Sangster, Stoeckl, McKenty, J. M. McNaney, R. J. Leeper, C. L. Ruiz, G. W. Cooper, A. G. Nelson, G. G. A. Chandler, K. D. Hahn, M. J. Moran, M. B. Schneider, N. E. Palmer, R. M. Bionta, E. P. Hartouni, LePape, P. K. Patel, Izumi, Tommasini, E. J. Bond, J. A. Caggiano, Hatarik, G. P. Grim, F. E. Merrill, D. N. Fittinghoff, Guler, Drury, D. C. Wilson, H. W. Herrmann, Stoeffl, D. T. Casey, M. G. Johnson, J. A. Frenje, R. D. Petrasso, Zylestra, Rinderknecht, D. H. Kalantar, J. M. Dzenitis, Di Nicola, D. C. Eder, W. H. Courdin, Gururangan, S. C. Burkhart, Friedrich, D. L. Blueuel, L. A. Bernstein, M. J. Eckart, D.

- H. Munro, S. P. Hatchett, A. G. Macphee, D. H. Edgell, D. K. Bradley, P. M. Bell, S. M. Glenn, Simanovskaia, M. A. Barrios, Benedetti, G. A. Kyrala, R. P. J. Town, E. L. Dewald, J. L. Milovich, Widmann, A. S. Moore, LaCaille, S. P. Regan, L. J. Suter, Felker, R. C. Ashabranner, M. C. Jackson, Prasad, M. J. Richardson, T. R. Kohut, P. S. Datte, G. W. Krauter, J. J. Klingman, R. F. Burr, T. A. Land, M. R. Hermann, D. A. Latray, R. L. Saunders, Weaver, S. J. Cohen, Berzins, S. G. Brass, E. S. Palma, R. R. Lowe-Webb, G. N. McHalle, P. A. Arnold, L. J. Lagin, C. D. Marshall, G. K. Brunton, D. G. Mathisen, R. D. Wood, J. R. Cox, R. B. Ehrlich, K. M. Knittel, M. W. Bowers, R. A. Zacharias, B. K. Young, J. P. Holder, J. R. Kimbrough, Ma, K. N. La Fortune, C. C. Widmayer, M. J. Shaw, G. V. Erbert, K. S. Jancaitis, J. M. DiNicola, Orth, Heestand, Kirkwood, Haynam, P. J. Wegner, P. K. Whitman, Hamza, E. G. Dzenitis, R. J. Wallace, S. D. Bhandarkar, T. G. Parham, Dylla-Spears, E. R. Mapoles, B. J. Koziolowski, J. D. Sater, C. F. Walters, B. J. Haid, Fair, Nikroo, Giraldez, Moreno, Vanwonterghem, R. L. Kauffman, Batha, D. W. Larson, R. J. Fortner, D. H. Schneider, J. D. Lindl, R. W. Patterson, L. J. Atherton, and E. I. Moses. Assembly of High-Areal-Density Deuterium-Tritium Fuel from Indirectly Driven Cryogenic Implosions. 2012. PHYSICAL REVIEW LETTERS. 108 (21).
- Montgomery, D. S., N. Guler, K. A. Flippo, J. L. Kline, R. G. Watt, J. R. Fincke, G. P. Grim, B. J. Albright, A. C. Hayes-Sterbenz, L. W. Sherrill, R. Kirkpatrick, and P. Amendt. Indirect drive double shells as an alternative ignition design. 2014. LA-CP-14-00275.
- Paris, M. W., L. S. Brown, G. M. Hale, A. C. Hayes-Sterbenz, Jungman, Kawano, G. M. Fuller, E. B. Grohs, and Kuni-eda. Toward a self-consistent and unitary reaction network for bigbang nucleosynthesis. 2014. CNR*13 - FOURTH INTERNATIONAL WORKSHOP ON COMPOUND NUCLEAR REACTIONS AND RELATED TOPICS. 69.
- Paris, M., Hale, Hayes-Sterbenz, and Jungman. R-matrix Analysis of Reactions in the B-9 Compound System. 2014. NUCLEAR DATA SHEETS. 120: 184.
- Rundberg, R. S., M. M. Fowler, G. P. Grim, A. C. Hayes-Sterbenz, K. R. Jackman, G. Jungman, J. B. Wilhelmy, and C. Yeaman. Thulium activation by Reaction-In Flight neutrons. 2014. LA-UR-14-25857. Talk presented at American Chemical Society Meeting..
- Rundberg, R. S., R. J. Fortner, M. M. Fowler, J. M. Gostic, G. P. Grim, Jungman, A. C. Hayes, K. J. Moody, D. H. Schneider, D. A. Shaughnessy, and J. B. Wilhelmy. Status of prompt radiochemistry diagnostic development for the National Ignition Facility. 2012. ABSTRACTS OF PAPERS OF THE AMERICAN CHEMICAL SOCIETY. 244.
- Sayre, D. B., C. R. Brune, J. A. Caggiano, V. Y. Glebov, Hatarik, A. D. Bacher, D. L. Bleuel, D. T. Casey, C. J. Cerjan, M. J. Eckart, R. J. Fortner, J. A. Frenje, Friedrich, Gatu- Johnson, G. P. Grim, Hagmann, J. P. Knauer, J. L. Kline, D. P. McNabb, J. M. McNaney, J. M. Mintz, M. J. Moran, Nikroo, Phillips, J. E. Pino, B. A. Remington, D. P. Rowley, D. H. Schneider, V. A. Smalyuk, Stoeffl, R. E. Tipton, S. V. Weber, and C. B. Yeaman. Measurement of the T plus T Neutron Spectrum Using the National Ignition Facility. 2013. PHYSICAL REVIEW LETTERS. 111 (5).
- Scott, K. C. N., R. A. Gore, M. C. Anderson, J. H. Cooley, E. S. Dodd, F. W. Doss, M. R. Douglas, J. R. Fincke, D. A. Haynes, A. L. Hungerford, M. L. Potocki, L. W. Sherrill, M. E. Sherrill, C. W. Wilkerson, J. B. Workman, and M. J. Schmitt. Physics Challenges in Stewarding the Evolving Stockpile (U). 2013. LA-CP-13-00157; Viewgraph for Polar Direct Working Group ; February 5, 2013 ; Los Alamos, NM.
- Smalyuk, V. A., R. E. Tipton, J. E. Pino, D. T. Casey, G. P. Grim, B. A. Remington, D. P. Rowley, S. V. Weber, Barrios, L. R. Benedetti, D. L. Bleuel, D. K. Bradley, J. A. Caggiano, D. A. Callahan, C. J. Cerjan, D. S. Clark, D. H. Edgell, M. J. Edwards, J. A. Frenje, Gatu-Johnson, V. Y. Glebov, Glenn, S. W. Haan, Hamza, Hatarik, W. W. Hsing, Izumi, Khan, J. D. Kilkenny, Kline, Knauer, O. L. Landen, Ma, J. M. McNaney, Mintz, Moore, Nikroo, Pak, Parham, Petrasso, D. B. Sayre, M. B. Schneider, Tommasini, R. P. Town, Widmann, D. C. Wilson, and C. B. Yeaman. Measurements of an Ablator-Gas Atomic Mix in Indirectly Driven Implosions at the National Ignition Facility. 2014. PHYSICAL REVIEW LETTERS. 112 (2).
- Snell, C. M.. General method for charged particle radiochemistry in a code (U). 2014. LA-CP-14-01122. Poster presented at Nuclear Explosives Code Development Conference (NECDC) 2014 ; Los Alamos, NM ; October 20, 2014 .
- Snell, C. M., K. Stalsberg, J. M. Campbell, M. B. Lee, R. A. Gore, B. M. Haines, and K. Parsons. General method for charged-particle transport with isotope mix partition and coupled radiochemistry in a code (U). 2014. LA-CP-15-00075; paper submitted to Nuclear Explosives Code Developers Conference (NECDC), Los Alamos, NM, Oct. 2014.
- Stalsberg, K. L., R. A. Gore, C. M. Snell, and J. M. Campbell. Application of New Models Towards Understanding Mix and Burn in UGT's (U). 2013. LA-CP-13-01350; Talk presented at NEDPC 2013 ; Livermore, CA ; October 14, 2013.
- Stalsberg, K., R. A. Gore, J. Fincke, and J. Schwarzkopf. Application of New Mix and Burn Models in an ASC Code (U). 2013. LA-CP-13-00531; Presented at JOWOG 32 ; AWE, Aldermaston, UK ; June 3, 2013.
- Steinkamp, M. J., R. A. Gore, G. P. Grim, A. C. Hayes, and G. Jungman. Leveraging the national ignition facility (NIF) to better understand turbulence in support of US

nuclear stockpile stewardship. 2011. LA-UR-11-02992:
LDRD Poster.

Steinkamp, M. J., R. A. Gore, G. P. Grim, G. Jungman, M. Boswell, J. R. Fincke, A. C. Hayes-Sterbenz, and A. Klein. Using the National Ignition Facility (NIF) in Livermore CA to better understand materials mixing(U). 2012. LA-UR-12-24886: Poster presented at LDRD-Days ; 2012-10-23 - 2012-10-23 ; Santa Fe, New Mexico, United States.

Volegov, , C. R. Danly, D. N. Fittinghoff, G. P. Grim, Guler, Izumi, Ma, F. E. Merrill, A. L. Warrick, C. H. Wilde, and D. C. Wilson. Neutron source reconstruction from pinhole imaging at National Ignition Facility. 2014. REVIEW OF SCIENTIFIC INSTRUMENTS. 85 (2).

Wilson, D. C., R. J. Aragonese, T. N. Archuleta, D. P. Atkinson, M. A. Barrios, S. H. Batha, D. E. Bower, D. K. Bradley, R. A. Buckles, D. D. Clark, D. S. Clark, D. J. Clark, J. R. Cradick, C. R. Danly, R. D. Day, J. M. Dzenitis, O. B. Drury, V. E. Fatherley, Felker, J. P. Finch, D. N. Fittinghoff, Frank, R. A. Gallegos, F. P. Garcia, S. M. Glenn, G. P. Grim, Guler, A. H. Hsu, Izumi, S. A. Jaramillo, O. S. Jones, M. I. Kaufman, J. D. Kilkenny, G. A. Kyrala, Le Pape, S. N. Liddick, E. N. Loomis, S. S. Lutz, Ma, A. J. Mackinnon, R. M. Malone, Mares, M. M. Marinak, D. D. Martinson, McKenty, N. S. Meezan, F. E. Merrill, M. J. Moran, G. L. Morgan, Munson, D. H. Munro, T. J. Murphy, J. A. Oertel, M. V. Patel, P. J. Polk, Regan, G. P. Roberson, D. W. Schmidt, S. M. Sepke, B. K. Spears, Tommasini, Town, Traille, I. L. Tregillis, A. C. Valdez, P. L. Volegov, T. F. Wang, Weiss, C. H. Wilde, and M. D. Wilke. Comparing neutron and X-ray images from NIF implosions. 2013. In IFSA 2011 - SEVENTH INTERNATIONAL CONFERENCE ON INERTIAL FUSION SCIENCES AND APPLICATIONS. Vol. 59.

Wingate, C. A.. (U) Code user manual, Eulerian Applications Code team, Code version 1109.00, Last Revised: Oct 10, 2014. 2014. LA-CP-11-01448. User manual documentation portion written by Charles Snell..

Advancing the Fundamental Understanding of Fission (U)

Morgan C. White
20120077DR

Abstract

The SPIDER (SPectrometer for Ion DEtermination in fission Research) detector system has been built to enable the accurate measurement of the fission fragments yields for any available material and energy of interest. To date, measurements of the fragment yields are one of the most sparse data sets in nuclear science. Yet the need for these is high. The new system is capable of efficiently measuring individual fragments just nanoseconds after the fission event. When combined with the target fabrication capabilities of the radiochemistry facilities at LANL and the neutron sources available at the Los Alamos Neutron Science Center (LANSCE), this will enable NNSA programs to make a wide range of new measurements.

While measurements are necessary, they rarely capture every aspect of a process and theory is needed to fill in the gaps. The SPIDER project has also delivered new theoretical models to describe the fission event. These theories hold the promise to help extend the usefulness of these new measurements and provide fundamental insights into the fission process. Applying improved fission fragment yield data requires a deeper understanding of the fission process.

Fission fragment yield data are essential to our interpretation of the fission process. They allow us to assess the performance of our historic US nuclear tests and provide forensics insights into foreign tests or emergency response events. Better understanding of the fission process will allow us to more efficiently develop and use the next generation of detection systems needed in non-proliferation and global security missions. Advanced measurements and theory will also deepen our understanding of the fission process, adding to our store of fundamental knowledge and enabling breakthrough science in the future.

Background and Research Objectives

Starting in the 1890s, physicists began to recognize atomic radiations – xrays – and nuclear radiations – alpha, beta, gamma rays – and to use these to probe the structure of the atom. In 1909, Hans Geiger and Ernest Marsden working under the direction of Ernest Rutherford proved the atom had an infinitesimally small, charged nucleus at its center by scattering an alpha particle off a thin gold foil. Regarding this experiment, Rutherford is often quoted, “It was quite the most incredible event that has ever happened to me in my life. It was almost as incredible as if you fired a 15-inch shell at a piece of tissue paper and it came back and hit you.” This was followed in 1911 with Neils Bohr’s quantification of the electron states and the modern form of the atom was complete.

It took two more decades to discover the neutron – James Chadwick in 1932 – and firmly establish the field of nuclear physics. The modern nucleus consists of tightly bound protons and neutrons – together known as nucleons – forming the core of an atom. This was the heyday of nuclear physics as scientists raced to discover the next element or breakthrough understanding of fundamental properties. However, just as with the erroneous concept of the ‘plum pudding’ atom, common wisdom held that small numbers of nucleons might be ‘chipped off’ the nucleus or even added, but the concept of splitting the nucleus – fission – was ridiculed.

Fission is different. The nucleus of heavy elements – e.g. uranium-235 with 92 protons and 143 neutrons – is unstable and with only a moderate push can be made to start a suite of oscillations that end with the nucleus cleaved in two (Figure 1). Lisa Meitner and Otto Frisch were the first to recognize this process (1937) for what it was and apply the term fission (adapted from the biological process). Where other reactions involve a clearly identified incident particle and target resulting in specific nuclear particle emissions and residual nucleus, fission

splits the nucleus in random ways that in any given event may result in two of more than one thousand possible fission fragment combinations.

It was quickly realized that fission released an enormous quantity of energy. Compared to common chemical reactions, e.g. explosives, fission releases more than ~20-200 million times more energy. Even compared to other nuclear reactions, fission releases ~10-100 times more energy. The potential use of this process as an energy source for commercial or military endeavors was recognized and so began the era of nuclear weapons and nuclear energy.

Despite more than seven decades of study, our theoretical understanding of fission is still primitive. There are many phenomenological models and even some first principles models, but the assumptions that must be made to make these models tractable are questionable. Experimental measurements are required to provide guidance in their development and validation of their use.

Measuring the fission fragment distributions is among the most challenging nuclear physics experiments. The distribution is sensitive to the nuclei undergoing fission – distributions must be measured for each nucleus of interest – and to the energy of the particle causing fission – measurements of each energy are necessary. The existing data cover a very limited set of nuclei and energies.

Our project, Advancing The Fundamental Understanding of Fission, aims to improve both measurement and theory capabilities. First, build a detector system that is capable of measuring any target of interest at key energies of interest. Second, challenge theoretical model development with such experimental data.

Scientific Approach and Accomplishments

There are three techniques in use to measure fission fragment distributions. In the jargon of the experimental community, these are the activation, '2E' and '2E-2V' techniques. Of these, the 2E-2V technique used in the current approach is the most difficult to instrument but offers potentially the best accuracy and the capability to measure any target or energy of interest. In keeping with the challenge for LDRD to provide revolutionary breakthroughs, the SPIDER detector system has the potential to measure more data with higher accuracy than ever before.

To understand these three techniques, it is necessary to examine the process of fission. In sequence, an excited nucleus undergoes oscillations that lead to fission into two primary fragments. Because of their charged state, they accelerate away from each other at high velocities quickly transferring this intense kinetic energy to the surround-

ing matter. Prompt neutron and gamma-ray emissions are then emitted leaving so-called secondary fission fragments. Finally, these radioactive fragments emit delayed neutrons, gammas and betas. This last step takes milliseconds to days where the previous steps happen in less than a nanosecond.

The first measurements of fission made by Hahn and Strausmann, and the bulk of such measurements since, were activation measurements. A sample is irradiated causing fissions and the fission products are subsequently measured via radiochemical or mass spectrometer methods. These measurements can be made with exceptional precision. However, only a limited number of the fission products are measured in such experiments and these measurements are only able to examine the last step of fission product decay.

The challenge is to measure the fission fragments just after they separate. While we cannot quite see that point, the 2E and 2E-2V methods measure the kinetic energy – 2E – and velocity – 2V – of the fragments just after prompt particle emission. These techniques use the relationship between the mass, velocity and energy of the fragments (Einstein's famous energy equals one-half mass times velocity squared) to infer the mass. The 2E method has to assume a velocity but bounding techniques allow this to be done with 4-6 mass unit resolution. The 2E-2V method can reach one mass unit resolution and is the measurement technology pursued here.

This project has delivered a two-arm 2E-2V system known as the SPIDER detector (Figure 2). The target material is held at the center of the vacuum chamber. Neutrons enter through a thin window and interact to cause a fission. The fission fragments are emitted back-to-back and each passes through two pick-off detectors that measure start and stop times as it traverses a known distance; this gives the velocity. The fragment then passes into an ionization chamber that measure its kinetic energy. The challenge of measuring the velocity is that it requires the fragments to pass through thin foils for each pick-off detector and the window to the ionization chamber. A correction must be made for the kinetic energy lost to each foil. To achieve one mass unit resolution the foils must be kept exceptionally thin. In addition, a reasonable (~meter) flight path is necessary to accurately measure the velocity. Highly accurate pick-off detectors tend to have small surface area, meaning that the overall detection efficiency tends to be very low (less than 1 in 1000).

SPIDER is one of a handful of 2E-2V systems ever to be fielded and has made significant breakthroughs in windows and total efficiency. Thin carbon foils (so thin one

can see through them) are used in the timing detectors. And the detectors themselves are a factor of 35 larger than any previously fielded increasing the overall efficiency by more than a factor of 10. Lastly, our team fielded the first successful use of silicon-nitride windows for the ionization chamber. These windows are only 200 nanometers thick and yet separate the low-pressure (1/5 atmospheric) ionization chamber gas from the vacuum chamber. With these breakthroughs the detector has demonstrated measurements of californium-252 fission fragments with order one mass unit resolution.

While measurements are necessary, they rarely capture every aspect of a process and theory is needed to fill in the gaps. The SPIDER project has also delivered new theoretical models. The first of these is a fitting tool that allows extrapolation of distributions across the full range of fragments and energies. This tool is essential to help fill in the gaps from limited measurements to provide the full range of data necessary for applications work, e.g. interpreting weapons yield. Using this tool, for example, measurements of distributions at thermal incident neutron energies – which can be done more quickly – can be extrapolated to infer their energy dependence. Obviously, the more data used in the fit, the more precise the final dataset.

Data fitting does not necessarily expose the underlying physics, thus an advanced modeling capability has been created to track the evolution of the nucleus through its oscillations to the point of fission. As shown in Figure 3, each possible shape of the nucleus has a potential energy associated with it. Given an initial excitation, a new capability has been developed to use Monte Carlo simulations to track the nucleus as it traverses this energy landscape to its eventual split into fragments. The stochastic fluctuations in this process are responsible for the diverse set of fission fragments (~1000) that may occur. This advanced modeling has helped us gain new insights into the nuclear temperature associated with the fission process, the final movements of nuclei between the fragments as the neck snaps, and other fundamental properties of the nucleus at the time of fission.

Impact on National Missions

Fission is the fundamental driving force in nuclear weapons and nuclear energy. Our understanding of this basic process has impacts on national strategy for deterrence enabled by stockpile stewardship; climate and energy policy by nuclear energy; and, global security through non-proliferation. Improving our understanding of fission has an extensive impact, in both expected and sometimes unanticipated ways.

Our ability to diagnose the yield of our own historic

nuclear tests is only as accurate as the fission fragment distributions on which these activities rely. As we develop improved nuclear weapons simulation capabilities, the ultimate accuracy – and thus predictive capability – of these codes is inherently limited by the quality of the experimental data, from analysis of our nuclear test archives, by which they are validated. Of the experimental quantities of interest, quantifying the total number of fissions – and thus the energy, or yield, produced – requires detailed, accurate fission fragment distributions. The total number of fissions is determined by measuring the fission fragments produced and using their yields to then infer the number of fissions. As the raw measurement data are still available, any improvement in our understanding of fission fragment distributions improves the accuracy of data we infer from these historic archives and can then enhance our predictive capabilities. Our ability to predict nuclear weapons performance underpins our ability to certify the safety and efficacy of our nuclear stockpile as it ages or is refurbished.

In the event of a nuclear explosion, part of our national emergency response is the capability to provide forensic analysis of the device. A cornerstone of counter-proliferation is the deterrence provided by the extent to which others believe we can ultimately attribute their actions. Because the mix of fragments is dependent on the nucleus that fissioned, they play a key role in determining the original material used in the device. Their sensitivity to energy also helps determine the device performance. However, the extent to which they inform the forensics process is again ultimately limited by the accuracy of the underlying fundamental data.

Monitoring activities as part of non-proliferation requires both invasive and remote sensing techniques. The use of fission fragment data to interpret results using invasive techniques has overlap with their use in weapons analysis and improved data accuracy has similar implications. Here it is remote sensing of gamma and neutron emissions that truly benefits. Current practice requires potential signatures to be measured experimentally in a time consuming and expensive process. Better understanding of the fission fragments offers a breakthrough allowing these signatures to be predicted. With accurate fission fragment distributions, simulations can track the event-by-event emission of neutrons and gammas during the fission process and the subsequent radioactive decay of the fission products. This is a wealth of new data that may be mined – using simulations that are relatively inexpensive – to search for new potential signatures.

Understanding fission is critical to optimizing the nuclear fuel cycle. Like the yield of a weapon, fission products are used to infer the burnup of nuclear fuel. As the industry

works to optimize fuel cycles with higher burnup – and thus more efficient – fuels, more accurate fundamental data is needed to better predict safety and performance expectations. The creation of fission product poisons, and their subsequent destruction, affects the timing and patterns for fuel loading. The creation of hydrogen and helium from subsequent nuclear interactions with the fragments affects the material safety. There are many inadequacies in our current understanding of fission products that we have been able to bootstrap solutions for the current assortment of reactors. Advanced reactor design and alternate, particularly accelerator, nuclear waste transmutation concepts require more accurate fundamental data to reduce their development cost and time.

The splitting of the atom captured the imagination almost eight decades ago. Despite intense study during that time, we are far from a basic science understanding of the fission process. Detailed measurements of the fission fragments for suites of materials and a wide range of energy provide data that challenges nuclear theory. In addition to the many practical benefits that new measurements using this detector will provide, there will also be the intangible, and often unexpected, benefits that occur when we advance our fundamental understanding of how the world works.



Figure 1. The concept of nuclear fission as first described by Lise Meitner and Otto Frisch in 1937.

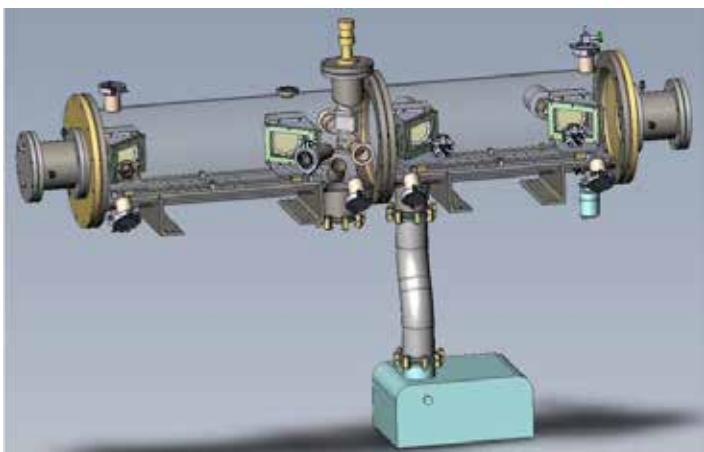

Figure 2. The SPIDER detector system including (left to right) an ionization chamber, two timing pick-off detectors, the fission target mounting and a mirror image second arm to allow simultaneous measurement of both fission fragments.

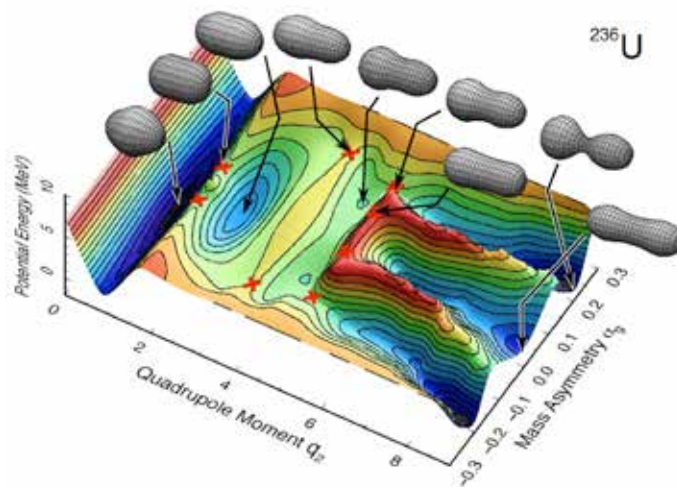

Figure 3. The potential energy landscape traversed as a nucleus deforms from its ground state to fission.

Publications

Arnold, C. W., F. K. Tovesson, K. C. Meierbachtol, A. B. Laptev, T. A. Bredeweg, M. Jandel, R. O. Nelson, and M. C. White. SPIDER: A Path to 1 AMU Resolution of Neutron-Induced Fission Fragments. Presented at Division of Nuclear Physics of the American Physical Society, (Newport Beach, CA, 24-27 Oct. 2012).

Arnold, C. W., F. Tovesson, K. C. Meierbachtol, A. B. Laptev, T. A. Bredeweg, M. Jandel, R. O. Nelson, and M. C. White. Precision Velocity Measurements of Fission Fragments Using the SPIDER Detector. 5. 119 (0): 392.

Arnold, C. W., F. Tovesson, K. Meierbachtol, T. Bredeweg, M. Jandel, H. J. Jorgenson, A. Laptev, G. Rusev, D. W. Shields, M. White, R. E. Blakeley, D. M. Mader, and A. A. Hecht. Development of position-sensitive time-of-flight spectrometer for fission fragment research. 2014. 764 (0): 53.

Jandel, M.. Neutron-Induced Fission Measurements Using DANCE and LSDS Facilities at LANL. Presented at Dynamical Aspects of Nuclear Fission (DANF2011). (Smo-lenice, Slovakia, October 17, 2011).

Lestone, J. P., and T. T. Strother. Energy Dependence of Plu-tonium and Uranium Average Fragment Total Kinetic Energies. 4. 118 (0): 208.

Meierbachtol, K. C.. LDRD Review - SPIDER Detector Ioniza-tion Chamber Component. 2012. LA-UR-12-25207 Pre-sentation to LDRD Review October 4, 2012.

Meierbachtol, K. C., F. K. Tovesson, C. W. Arnold, A. B. Laptev, T. A. Bredeweg, M. Jandel, R. O. Nelson, and M. C. White. A High Resolution Ionization Chamber for the SPIDER Fission Fragment Detector. Presented at 5th International Conference on Fission and Prop-erties of Neutron-Rich Nuclei (ICFN5) [LA-UR-12-23824].

(Sanibel Island, FL, 04-10 Nov. 2012).

Meierbachtol, K., F. Tovesson, C. W. Arnold, A. B. Laptev, T. A. Bredeweg, M. Jandel, R. O. Nelson, and M. C. White. Development of an Ionization Chamber for the SPIDER Fission Fragment Detector. 5. 119 (0): 389.

Moeller, J., J. Randrup, Iwamoto, and Ichikawa. Fission-fragment charge yields: Variation of odd-even staggering with element number, energy, and charge asymmetry. 2014. PHYSICAL REVIEW C. 90 (1).

Moller, P., J. Randrup, and A. J. Sierk. Calculated Fission Yields of Neutron-Deficient Mercury Isotopes. 2012. Physical Review C (Nuclear Physics). 85 (2): 024306 (6 pp.).

Möller, P., J. Randrup, A. Iwamoto, and T. Ichikawa. Fission-fragment charge yields: Variation of odd-even staggering with element number, energy, and charge asymmetry. 2014. Physical Review C. 90 (1): 014601.

Sierk, A. J., J. P. Lestone, and P. Moller. Calculating Fission-Fragment Distributions. Invited presentation at 2012 Tri-Lab Nuclear Data Workshop. (Los Alamos, NM, 05-07 Mar. 2012).

Tovesson, F. K.. LDRD Review - SPIDER Detector Instrument Overview. 2012. LA-UR-12-25411 Presentation to LDRD Review October 4, 2012.

Tovesson, F. K., T. A. Bredeweg, A. B. Laptev, K. C. Meierbachtol, C. W. Arnold, M. C. White, A. Hecht, D. Mader, and R. Blakeley. SPIDER: A New Instrument For Fission Yield Measurement. Presented at 5th International Conference on Fission and Properties of Neutron-Rich Nuclei (ICFN5) [LA-UR-12-23883]. (Sanibel Island, FL, 04-10 Nov. 2012).

Tovesson, F., C. Arnold, A. Laptev, K. Meierbachtol, M. White, R. Blakeley, A. Hecht, D. Mader, and L. Snyder. SPIDER: a new instrument for fission fragment research at the Los Alamos Neutron Science Center. 2013. In Fifth International Workshop on Nuclear fission and Fission-Product Spectroscopy. (Caen, France, May 28, 2013). , p. 1. Los Alamos: LANL Report Library.

Physics Beyond the Standard Model with the Long-Baseline Neutrino Experiment

Christopher M. Mauger
20120101DR

Abstract

The laws of physics largely obey symmetry between particles and anti-particles. On the other hand, there is a large, observed matter-anti-matter asymmetry in the universe (thus the existence of our species). One of the principal focuses of elementary particle physics is to test the laws of physics to find places where they do not obey particle-anti-particle symmetry (called charge-parity [CP] symmetry). Currently, a process called leptogenesis is the most promising idea to explain the matter-anti-matter asymmetry of the universe. The United States particle physics program is searching for CP violation among particles called leptons and is developing a neutrino oscillation program for these studies. Neutrinos, a type of lepton, have the lowest cross-sections of any known particles in the universe and thus present many challenges in their study. The focus of the work described in this report has been to enhance the physics reach of the U.S. long-baseline neutrino program through a robust program of theoretical calculations, detector simulations, particle physics measurements and detector development. The theoretical program improved our understanding of neutrino nucleus cross-sections in an energy regime critical for the success of the neutrino oscillation program, advanced studies of neutrino non-standard interactions and produced detailed studies of how neutrino spectra from supernova bursts differ depending on the ordering of the neutrino masses. The simulation program explored neutrino energy reconstruction and identified, for the first time, the importance of accounting for outgoing neutrons. The team led measurements at the NA-61 experiment to develop methodologies for determining the absolute neutrino fluxes produced in the U.S. program. Finally, the detector development effort created a liquid argon time-projection chamber.

Background and Research Objectives

The matter-anti-matter asymmetry of the universe is one of the key scientific issues of our day [1]. The United

States has embarked on a program to understand the origin of this asymmetry and it is one of the major fields of study for the U.S. particle physics program [2]. A key component of the approach is to search for regimes in the laws of physics where the symmetry between particles and anti-particles is broken, that is, the violation of charge-parity (CP) symmetry. If the laws of physics were completely CP symmetric, matter and anti-matter would have been made in the same quantities during the big bang, evolved symmetrically and subsequently completely annihilated with each other leaving no matter behind. The fact of our existence implies that CP must be violated. Currently, the most promising theory explaining the matter-anti-matter asymmetry is leptogenesis. This makes searching for CP violation amongst leptons a top priority. The most straightforward way to do this is to make precision measurements of neutrino oscillation phenomena.

The U.S. long-baseline neutrino (LBN) program is under development. The plan includes an intense neutrino source at the Fermi National Accelerator Laboratory (FNAL), a highly capable set of near detector systems at FNAL, and a massive liquid argon time-projection chamber (TPC) deployed underground at the Sanford Underground Research Facility (SURF) located in the former Homestake gold mine in western South Dakota. The intense neutrino source can be configured to make predominantly muon neutrinos or muon anti-neutrinos. The conversion rates from muon neutrinos to electron neutrinos, and separately muon anti-neutrinos to electron anti-neutrinos, after they propagate the 1300 kilometers from FNAL to SURF will be determined as a function of (anti) neutrino energy. These conversion probabilities will be compared to determine if and by how much neutrinos and anti-neutrinos behave differently.

Since the neutrino beam consists of a very broad energy spectrum, it is crucial to have a detailed understand-

ing of uncertainties in energy reconstruction - especially those that differ between neutrinos and anti-neutrinos. There are many components that are crucial to addressing this problem. First, the absolute neutrino flux must be determined precisely as a function of energy. Next, accurate cross-sections are required to predict the event rates as a function of energy. It is especially important to have a detailed understanding of the event topologies as a function of neutrino energies. Further, it is crucial to fully examine all of the physics that can potentially impact the conversion probabilities such as Non-Standard Interactions (NSI) involving neutrinos. Finally, using the flux and cross-sections as input, it is crucial to understand the event signatures in the detectors deployed in the LBN program. In addition to the long-baseline neutrino oscillation physics, the large underground far detector enables many other important physics studies including the possibility to detect neutrinos from a galactic supernova burst. Neutrino oscillation phenomena impact the expected neutrino energy distributions and their time-dependence. Due to the very dense environment, there is a rich expected phenomenology, but the complexity is daunting. Careful calculations using supercomputers are required to explore this topic.

The neutrino beam is produced by impinging an intense proton beam on a carbon target, thereby producing an intense flux of charged pions that decay to neutrinos - in the case of positively charged pions - or anti-neutrinos - in the case of negatively charged pions. The intensity of the charged pions is about $10^8/\text{cm}^2\text{-s}$, and thus it is impossible to make direct measurements of pions to infer the neutrino flux and spectrum. Instead, careful measurements of the downstream yield of pions and other hadrons and their propagation are necessary. In the past, such measurements have been carried out to the 7% level with a resultant impact on the uncertainties on the neutrino fluxes of 10% [3] [4]. The goal for the LBN program is a neutrino flux uncertainty of about 3% - requiring uncertainties on the hadro-production cross-sections of <1%. This challenging goal is tackled with a high-precision hadro-production experiment.

Neutrino cross-sections on complex nuclei in the energy regime where the LBN program will operate are highly uncertain. Previous calculations of one of the significant interaction channels, called quasi-elastic scattering, treat the nucleus as a non-interacting collection of nucleons. Project team members had developed methodologies to properly account for two-body correlations in the nucleus and calculated electron scattering cross-sections on three and four-nucleon systems. In this project, the work was extended to treat neutrinos, treat higher incoming lepton energies, and treat larger nuclei.

Non-standard interactions (NSI) involve the possibility of more complicated interactions between neutrinos and the matter it passes through between the place where they are produced and where they are detected. Such effects can be large due to their magnification by quantum interference. Even NSIs that are 5-10 times smaller than the standard weak mixing potential can have a large effect on the muon to electron neutrino conversion probability at baselines of 800 km or more. The team studied the impact of these NSI on the oscillation probabilities of several long-baseline neutrino experiments.

The LBN program uses a broadband beam of neutrinos (and anti-neutrinos), so reconstructing the neutrino energy based on the visible particles is crucial. The team simulated the impact of missing the neutrons on the neutrino energy reconstruction.

Another key aspect of the project was the detailed study of neutrinos in the supernova environment. The dynamics of neutrino flavor oscillations in a supernova is rich and complex and proceeds under physical conditions that cannot be reproduced in the laboratory. In particular, the density of neutrinos is so high that the flavor states on different trajectories become coupled. The system thus evolves collectively, exhibiting many-body effects that are not apparent in the single-particle Hamiltonian. The efforts to model this phenomenon, both analytically and numerically, with supercomputers, have been underway for the last ten years. A rich set of behaviors has been uncovered. The team in this project explored these behaviors.

Finally, the team constructed a liquid argon time-projection chamber to develop the technical expertise required to assure systematic uncertainties remain under control for LBN. The detector is one of the few ever constructed in the United States [5].

Scientific Approach and Accomplishments

Neutrino physics is a challenging endeavor. Neutrino beams are made in complex dynamical systems. Since they are not charged, one cannot manipulate the neutrino beam the way one can manipulate charged particle beams, for example selecting particle momenta with magnetic fields. One must have accurate ways to predict and measure the flux in order to understand it. A crucial approach is with hadro-production experiments, as discussed above. In order to attain high-precision results – 1% measurements on the production of charged mesons – one must go beyond past experiments in several significant ways. The team organized a larger group of researchers from several universities and laboratories across the U.S. to take ad-

vantage of a running experiment called NA-61. The NA-61 experiment is predominantly focused on the study of the collisions of heavy ions. As such, the original experimental team developed exquisite tracking devices capable of making high-precision measurements of events with hundreds of charged-particle tracks. The DR team realized this same apparatus could be employed to make hadro-production measurements with unprecedented precision since the important interactions have much lower multiplicity than heavy ion collisions. Initial data were taken in the summer of 2012. The data have led to hadro-production results at the targeted precision for a small portion of the important phase space. This led to the development of a multi-year, hadro-production program using the NA-61 apparatus that is now supported by the Department of Energy's (DOE) Office of High Energy Physics (OHEP) [6].

The DR team advanced the state of understanding of quasi-elastic electron and neutrino scattering from nuclei. First, we investigated neutrino scattering from the deuteron [7]. Two-nucleon correlations and currents do not play a large role here because of the weak binding of the deuteron. However, we extended previous calculations to higher neutrino energy, and compared neutrino and anti-neutrino cross-sections. Our calculations included all the relevant two-nucleon processes that are important in larger nuclei. For the deuteron, all the final states can be calculated explicitly; hence it provides a very strong check on the Monte Carlo calculations that we perform for larger nuclei. The deuteron could potentially be a useful experimental target because of its relative simplicity; in particular it could serve to check the normalization of the neutrino flux in experiments.

We then calculated electron scattering in Carbon-12 [8]. This had become possible with the much larger computational resources available compared to ten years ago. We found that the previous results found in Helium, that the transverse response is enhanced by approximately 50%. The source of these enhancements is exactly the same as for Helium, showing that these correlations and currents significantly affect the cross-sections for all nuclei. This is not surprising, since the momentum transfers are of the order of the inverse spacing between nucleons, and all nuclei have the same density. However it is important to have this confirmation of the enhancement that was seen experimentally was due to the same physics arising in very light nuclei.

Subsequently we calculated the sum rules for the five response functions relevant to neutrino and anti-neutrino scattering. In addition to the longitudinal (charge) and transverse (current) scattering, 3 other responses including the axial response and vector-axial interference terms

are important. The sum rules involve integration of the response over all energy. Using the same models of electroweak currents we used for the deuteron we calculated the electroweak sum rules, finding substantial corrections to all the response functions except the longitudinal charge response. This may have an important impact on present and future neutrino experiments [9].

The team has studied the sensitivity of LBNE and other long-baseline neutrino oscillation experiments to non-standard interactions (NSI). Importantly, the NSIs bring in additional CP-violating phases. The question then arises whether the "standard" and the "novel" CP phases could be confused. This is indeed so at NovA, a precursor experiment to LBNE, as can be explicitly seen in Figure 1 which shows neutrino and antineutrino survival probabilities with only the vacuum induced oscillations (two rings) and with the addition of new interactions (filled regions). The blue color corresponds to the normal mass hierarchy, while the red one is for the inverted hierarchy. Notice that the same probabilities for both neutrinos and antineutrinos at NovA could be obtained with very different CP-violating phases. Combining measurements at different energies and baselines should resolve these degeneracies [10]. This is further motivation for the LBN program to be carried out at 1300km.

The team simulated the impact of neutrons – especially what happens if they are missed – on neutrino energy reconstruction (Figure 2). Figure 3 shows the impact is different for neutrinos and anti-neutrinos – a serious issue for an experiment searching for CP violation. The DR team built a large national collaboration and developed a physics program using the liquid argon TPC that has been built. The program has strong HEP support and will take advantage of unique LANL facilities.

Finally, the team has made detailed studies of supernova neutrinos. One of the many interesting behaviors discovered by the team is that neutrinos scattering above the neutrinosphere, despite being a relatively small fraction of all emitted neutrinos, could nonetheless have profound impact on collective flavor transformations at the early stages of the explosion. The team calculated the first ever explicit and self-consistent computation of the effect of such scattered neutrino "halo" on the overall flavor evolution [11]. Of note, during the neutronization burst stage, the distributions of the scattering matter are spherically symmetric, making explicit numerical calculations possible. The results demonstrate that the presence of the scattering Halo indeed modifies the collective evolution of the neutrino flavor states and impact the spectra observable on Earth.

Most recently, the team investigated the role of background matter in triggering of collective oscillations. The standard lore in the field had been for many years the background matter potential was unimportant for the evolution and could be “rotated away”. Numerical calculations in several regimes seemed to support this view. As shown in [12], however, a dramatic violation of this Matter-Does-Not-Matter hypothesis exists. In environments with an accretion disk, a resonant level-crossing between the matter and neutrino self-interaction potentials is possible. This level-crossing can result in nearly complete flavor transformation of electron neutrinos, while electron anti-neutrinos are returned to the initial state.

Finally, the team provided neutrino spectra to LBNE (Figure 4).

Impact on National Missions

The work in this DR project has had a significant impact on the flagship experiment of DOE’s OHEP. The work on hadro-production will lead to significant constraints on the calculated neutrino flux and spectra for the LBN program. It has brought a new experimental effort to LANL’s neutrino physicists and new visibility for LANL at OHEP. The neutrino cross-section work has brought about the possibility of OHEP support directly or via Fermilab to develop it further. The NSI and supernova work has high visibility in HEP. The supernova work, in particular, is synergistic with other laboratory programs. Finally, a vigorous multi-institutional collaboration and physics program has developed around the liquid argon TPC. The program has strong support from the LBN program and HEP. It provides a crucial venue for LANL physicists – especially postdoctoral scholars to develop hands-on experience with the detector technology on which the HEP community is banking. Work like this, which involves detection at the extremes, builds capability for nuclear sensing in applied missions like stockpile stewardship and nuclear nonproliferation.

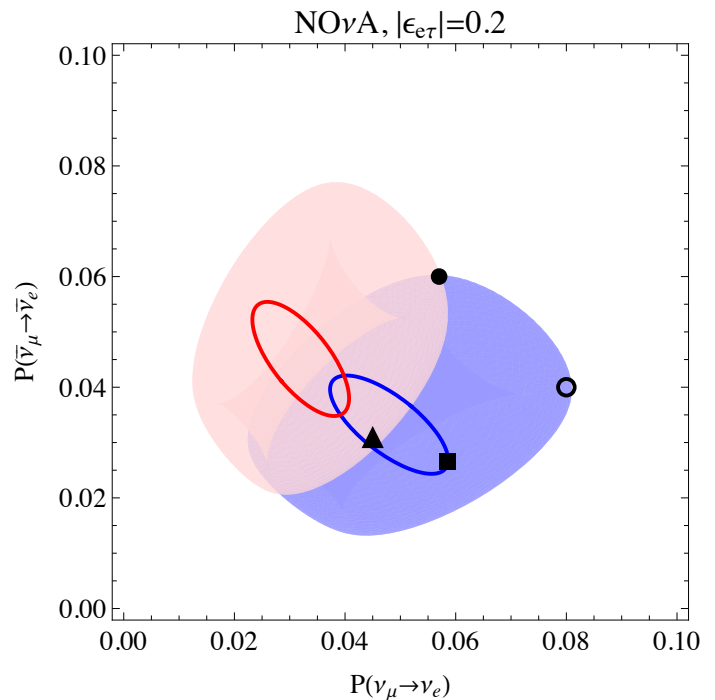

Figure 1. Neutrino and antineutrino survival probabilities with only the vacuum induced oscillations (two rings) and with the addition of new interactions (filled regions). The blue color corresponds to the normal mass hierarchy, while the red one is for the inverted hierarchy.

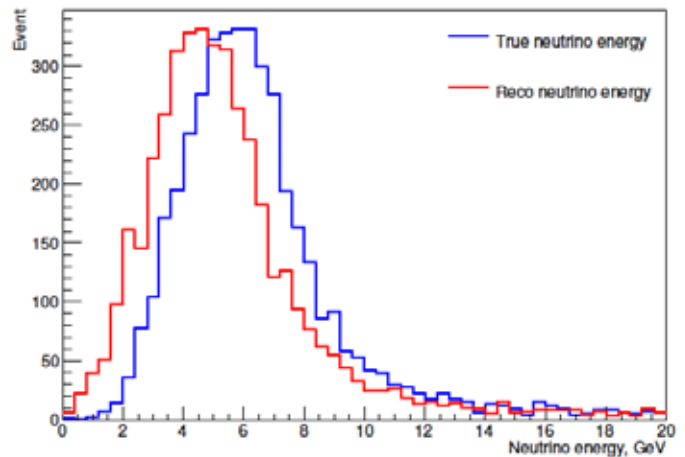

Figure 2. The blue curve represents the true neutrino energy for neutrinos from the NuMI beamline (similar to LBNE). The red curve shows how the neutrino energy would be reconstructed if the neutrons are missed.

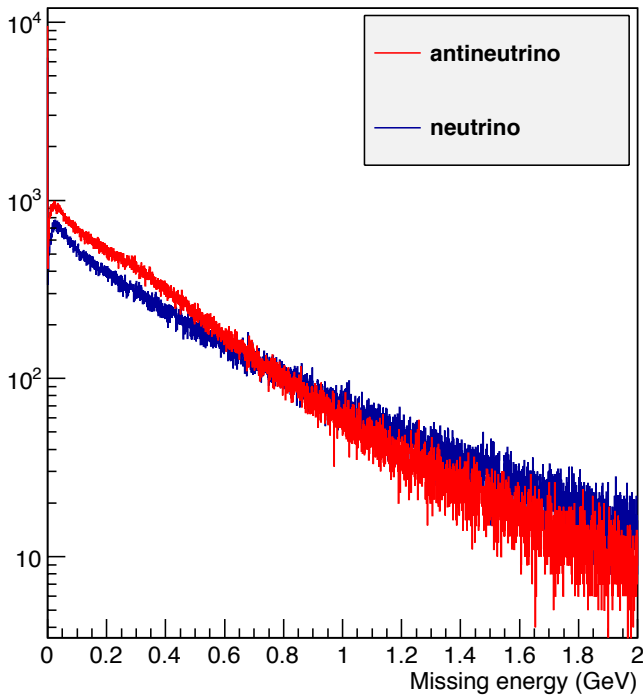

Figure 3. The red curve shows the energy lost for antineutrino events in the LBNE beam if no neutrons are reconstructed. The blue shows the same for neutrinos. The fact that there is a difference between these two distributions indicated if the problem is not under control, the interpretation might be a false positive for CP violation.

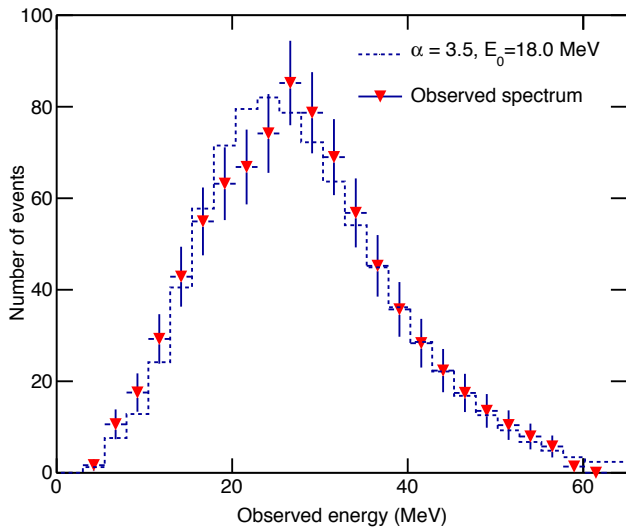

Figure 4. The neutrino energy distribution as would be measured in the LBNE underground far detector. The spectra were provided by the DR team.

References

1. Quantum Universe. . 2008. HEPAP Reports. .
2. LBNE Experiment. 2010. FNAL LBNE Experiment.

3. Aguilar-Arevalo, A. A., and e. tal. The MiniBooNE Detector. 2009. Nuclear Instruments and Methods A. A599: 28.
4. Aguilar-Arevalo, A. A., and e. tal. The Neutrino Flux prediction at MiniBooNE. 2009. Physical Review D. D79: 072002.
5. al, C. Mauger et. The CAPTAIN Physics Program. 2013. Arxiv .
6. Hadron Production Measurements at the CERN NA61 Spectrometer. 2014. CERN.
7. Shen, G., L. E. Marcucci, J. Carlson, S. Gandolfi, and R. Schiavilla. Inclusive neutrino scattering on the deuteron from threshold to GeV energies . 2012. Physical Review C. C86: 0355033.
8. Lovato, A., S. Gandolfi, R. Butler, J. Carlson, E. Lusk, S. C. Pieper, and R. Schiavilla. Charge Form Factor and Sum Rules of Electromagnetic Response Functions in ^{12}C . 2013. Physical Review Letters. 111: 092501.
9. Lovato, A., S. Gandolfi, J. Carlson, S. C. Pieper, and R. Schiavilla. Neutral weak current two-body contributions in inclusive scattering from ^{12}C . 2014. Physical Review Letters. 112: 182502.
10. Friedland, A., and I. Shoemaker. Searching for Novel Neutrino Interactions at NOVA and Beyond in Light of Large theta₁₃. Physical Review D.
11. Cherry, J., J. Carlson, A. Friedland, G. Fuller, and A. Vlasenko. Halo Modification of a Supernovae Neutronization Neutrino Burst. 2013. Physical Review D. D87: 085037.
12. Malkus, A., A. Friedland, and G. McLaughlin. Matter-Neutrino Resonance Above Merging Compact Objects. Physical Review Letters.

Publications

Abazajian, K. N., E. Calabrese, A. Cooray, F. De Bernardis, S. Dodelson, A. Friedland, G. M. Fuller, S. Hannestad, B. G. Keating, E. V. Linder, C. Lunardini, A. Melchiorri, R. Miquel, E. Pierpaoli, J. Pritchard, P. Serra, M. Takada, and Y. Y. Wong. Cosmological and astrophysical neutrino mass measurements. 2011. ASTROPARTICLE PHYSICS. 35 (4): 177.

Akin, T., and A. Friedland. The 2010 Interim Report of the Long-Baseline Neutrino Experiment Collaboration Physics Working Groups. . 2011. e-Print: arXiv:1110.6249 .

Cherry, J., J. Carlson, A. Friedland, G. Fuller, and A. Vlasen-

ko. Neutrino scattering and flavor transformation in supernovae. 2012. *Physical Review Letters*. 108 (26): 261104.

Cherry, J., J. Carlson, A. Friedland, G. Fuller, and A. Vlasenko. Halo Modification of a Supernovae Neutronization Neutrino Burst. 2013. *Physical Review D*. D87: 085037.

Friedland, A., and I. Shoemaker. Searching for Novel Neutrino Interactions at NOvA and Beyond in Light of Large θ_{13} . *Physical Review D*.

Lovato, A., S. Gandolfi, J. Carlson, S. C. Pieper, and R. Schiavilla. Neutral weak current two-body contributions in inclusive scattering from ^{12}C . 2014. *Physical Review Letters*. 112: 182502.

Lovato, A., S. Gandolfi, R. Butler, J. Carlson, E. Lusk, S. C. Pieper, and R. Schiavilla. Charge Form Factor and Sum Rules of Electromagnetic Response Functions in ^{12}C . 2013. *Physical Review Letters*. 111: 092501.

Malkus, A., A. Friedland, and G. McLaughlin. Matter-Neutrino Resonance Above Merging Compact Objects. *Physical Review Letters*.

Mauger, C., G. Garvey, E. Guardincerri, D. Lee, Q. Liu, G. Mills, J. Mirabal-Martinez, J. Ramsey, K. Rielage, C. Sinis, C. Taylor, R. Van de Water, and A. Yarritu. The CAPTAIN Detector and Physics Program . 2013. arxiv.org .

Shen, G., L. E. Marcucci, J. Carlson, S. Gandolfi, and R. Schiavilla. Inclusive neutrino scattering off the deuteron from threshold to GeV energies. 2012. *Physical Review C (Nuclear Physics)*. 86 (3): 035503 (18 pp.).

Wiringa, R. B., R. Schiavilla, S. C. Pieper, and J. Carlson. Nucleon and nucleon-pair momentum distributions in A ^{12}C nuclei. 2014. *Physical Review C*. C89: 024305.

Nuclear and Particle Futures

Directed Research
Final Report

$k_{\text{effective}}$: First Measurement of Nanosecond-Pulsed Nuclear Reactivity on a Subcritical Assembly (U)

Anemarie Deyoung
20140059DR

Abstract

A central mission of the Stockpile Stewardship Program is to predict, detect, and evaluate potential problems of the nation's aging and changing stockpile. An issue of serious concern is whether defects in aging plutonium indirectly and adversely affect neutron multiplicity in fissioning systems. There are equally important applications to re-use, safety/surety and certification efforts. The Neutron Diagnosed Subcritical Experiment (NDSE) will quantify the neutron multiplication that is the fundamental mechanism that generates energy in nuclear weapons. To enable this experiment, we must develop novel gamma-ray detector technology to meet the requirements of the multiplication measurement. This technology includes new materials to achieve a signal with large dynamic range and ultrafast few-ns scale time response. We must also develop a robust pulsed neutron source based on Dense Plasma Focus (DPF) technology. The experimental development and theoretical analysis of the DPF system lie at the forefront of plasma physics.

In FY14, we carried out a feasibility study of the detector system. Two detector measurement laboratories were built for measurement of novel scintillator and Cerenkov detectors. Promising candidates were chosen; initial results were reported [1].

Background and Research Objectives

In the LDRD DR proposal we described a method to develop a precision measurement technique that enables determination of nuclear reactivity in a subcritical system comparable to the accuracy obtained in nuclear testing. Our goal is to enable the measurement of neutron multiplication in subcritical plutonium. The design of the package, including the high explosive system, is focused on obtaining the conditions and sensitivity required for the realistic evaluation of the impacts of aging plutonium on nuclear reactivity in stockpile systems (see the full LDRD DR proposal and classified addendum for details and other applications). Fission would be induced

in the plutonium using a DPF (Dense Plasma Focus) neutron source at the NNSS (Nevada National Security Site) which provides a narrow pulse of DT 14 MeV neutrons. The main observable determining prompt multiplication is the time history of the emitted prompt fission gamma-rays. This is the traditional Reaction History alpha measurement (equal to the log-derivative of the gamma signal). The magnitude and timing of the multiplication are extremely sensitive functions of the compression of the fissioning material. Our studies suggest that this needs to be determined to within < 1%. To attain this level of accuracy requires new measurement techniques.

The top level issues are: (1) Are there enough gammas to measure α with a statistical uncertainty of <1%? (2) Can the gammas be recorded with sufficiently low noise and large bandwidth to preserve the information on α ? (3) Can the data be analyzed to extract the value of α with a statistical uncertainty of <1%? (4) What are the sources of uncertainty and how can they be mitigated? Our proposal is to apply techniques from recent nuclear and particle physics experiments such as NPDGamma [2] to reduce the background noise: a current-mode data acquisition system can achieve noise close to the counting statistics. This will require a study of transient digitizer bit noise, scintillator decay time, possible use of Cerenkov detectors with no afterglow, cosmic ray background signal, scatter background reduction, and linearity and noise of the photodetectors.

Scientific Approach and Accomplishments

In FY14 we researched gamma detectors and performed a scoping study. We have used this to build two new detector laboratories where we have tested the response of PhotoMultiplier Tubes (PMT), PhotoDiodes (PD), and the gamma response of over ten scintillator and Cerenkov media. We have shown that if a detector system records > 1 photoelectron/incoming fission gamma, the minimum counting statistics uncertainty is met. We find that the system needs to have ultra fast time resolu-

tion and large dynamic range in current mode. Ideally, we would have no detector medium 'afterglow'; the photodetectors need to be linear over several orders of magnitude; the recording system must be capable of measuring over several orders of magnitude.

The advantages of a medium with fast time decay and no 'afterglow' led us to seriously consider Cerenkov detectors. We expect the average energy of leakage fission gammas to be ~1 MeV - since the Cerenkov effect creates light only for relativistic electrons, it has a natural threshold with no response to gammas of energy $\sim <0.5$ MeV thus filtering out unwanted low energy background signal. It is also less sensitive to neutrons (as compared with scintillators) making it an attractive candidate for future possible detectors that may be required closer to the package. Our studies indicate, however, that Cerenkov results in only a few photoelectrons per 1 MeV gamma. Implementation of this type of detector may be challenging as we would need to collect every photon in order to derive sufficient signal for a measurement. At this time the preferred medium is the Liquid A scintillator, but more development is required.

From our preliminary investigations it remains unclear as to how well PMTs will function in this type of measurement and warrants further investigation. Work performed with our collaborators at National Security Technologies (NSTec) indicates that two detectors have the potential to fulfill our specifications: a 2" diameter mesh PMT, and a 5" diameter photodiode with custom electronic amplification. Studies of the tube performance were initiated using the Dense Plasma Focus neutron source. Should no photodetectors span the dynamic range required, we could utilize two detectors to separately cover high and low gain portions of the signal. In addition, the team has developed a calculational tool to compare the relative performance of scintillators vs. Cerenkov: the larger scintillator signal with appropriate deconvolution of the afterglow compares favorably with the Cerenkov signal which inherently has higher noise due to fewer gammas.

As a result of this LDRD study, we now have a path forward on a method for building a gamma detector system for measuring k_{eff} to $<0.5\%$.

Impact on National Missions

This LDRD project will establish the technical feasibility of a future program in dynamic NDSE. Such a program would provide the first modern quantitative understanding of the neutronic properties of Pu at high pressures and, thus, provide experimental validation of weapons models. It would likely lead to a broader k_{eff} program at the Nevada National Security Site (NNSS, formerly NTS) to assess the useful lifetime of long-term-stored weapons Pu and other

applications (see Classified Addendum). It has important applications in the Global Security, Nuclear Engineering, and Non-proliferation arenas.

References

1. DeYoung, A., J. Hill, V. Yuan, G. Morgan, C. Hagen, A. Obst, T. Haines, N. King, R. Rundberg, and W. Myers. $k_{\text{effective}}$: First measurement of nanosecond - pulsed nuclear reactivity on a subcritical assembly: DAQ. 2014. In Nuclear Explosive Design Physics Conference (NEDPC) 2013. (Livermore, CA, March 2014). , p. 1. Livermore, CA: LLNL.
2. Gericke, M. T.. A current mode detector array for gamma-ray asymmetry measurements. 2005. Nuclear Instruments and Methods in Physics Research A . 540: 328.

Publications

DeYoung, A., J. Hill, V. Yuan, G. Morgan, C. Hagen, A. Obst, T. Haines, N. King, R. Rundberg, W. Myers, M. Boswell, M. Fowler, S. Sterbenz, J. Lestone, B. Lansrud-Lopez, E. Shores, J. Pedicini, A. Hayes, J. Payton, J. Gatling, D. Lowe, and W. Priedhorsky. $k_{\text{effective}}$: First measurement of nanosecond-pulsed nuclear reactivity on a subcritical assembly: DAQ. 2014. In Nuclear Explosives Design Physics Conference. (Livermore, CA, March 2014). Vol. LA-CP-14-00358, p. 1. Livermore, CA: LLNL Proceedings.

First Principle Study of Relativistic Beam and Plasma Physics Enabled by Enhanced Particle-In-Cell Capability

Chengkun Huang
20130744ECR

Introduction

The Particle-In-Cell (PIC) method is a fully kinetic ab-initio method widely used in plasma and particle beam modeling. Although the standard PIC method with the second order accurate numerical algorithm is well suited for the study of beam and plasma dynamics at low speed, its application to relativistic phenomena is severely limited. The major limitations come from the dispersive and anisotropic propagation properties of the electromagnetic (EM) wave on the grid, the numerical instability associated with the unphysical Cherenkov radiation, the inaccuracy in the relativistic particle kinematics and the undesirable noise from under-resolved dynamics. In this work we will develop, validate and apply a new computational framework so as to be able to compute and understand cutting-edge problems involving highly relativistic charged particles. Our approach is to address the deficiencies of the standard PIC method and include enhancements with carefully designed high order particle shapes/digital filters, a relativistically accurate particle pusher and most importantly a 4th-order accurate and tunable EM field solver developed recently. This enhanced PIC capability will provide, for the first time, accurate and self-consistent modeling for many relativistic beam/plasma problems of importance to LANL's mission and to the broader scientific community. Specifically, we will focus on (1) understanding how the microbunching instability can arise from the interactions between a highly relativistic beam and its radiation in a Free Electron Laser (FEL) bunch compressor and how it affects the beam quality and FEL performance; (2) investigation of the collisionless particle acceleration process in astrophysical shock and the deceleration process related to the collective wave-particle interaction in high-energy-density plasmas. The former application is directly relevant to the success of the MaRIE X-ray FEL signature facility while the latter addresses fundamental science questions in both astrophysics and a high-risk yet high-potential fast-ignition technology for inertial fusion energy.

Benefit to National Security Missions

The proposed work will establish a high-fidelity first-principle predictive modeling capability and improve the understanding of high current beams interaction with its coherent radiation and the kinetic plasma behavior under extreme conditions. We are pushing the envelope of the PIC method which is widely used in the lab for various DOE/NNSA projects in high energy density plasma, accelerator beam dynamics, astrophysics and space applications, thus yielding many scientific possibilities for LANL. The improved modeling capability and the new insights into the XFEL microbunching instability and particle acceleration/deceleration mechanisms link directly into LANL's missions of (1) Matter-Radiation Interactions in Extremes (MaRIE) Signature Facility, (2) Nuclear, Particle, Cosmology, and Astrophysics and (3) Nuclear Energy.

Progress

During the past 12 months, the project team was led by the PI and consisted of a summer graduate student and two postdocs (at 0.3FTE and 0.25FTE, respectively). The team has successfully tested a parallel high order Finite Difference Time Domain (FDTD) field solver and validated its accuracy in the phase velocity. LANL postdoc Yong Zeng (currently at Halliburton) was the lead on this work. The solver has been implemented into a production parallel Particle-In-Cell (PIC) code OSIRIS. A key component of the accurate electromagnetic solver for our relativistic beam and plasma modeling is the absorbing boundary condition that can be correctly matched to the order of the FDTD solver. We have extended the state-of-the-art absorbing boundary condition -- Perfectly Matched Layer (PML), into a high order PML boundary condition, which proves to be critical for stable high order calculation. With this new high order FDTD field solver and absorbing boundary condition, we have begun the study of the micro-bunching instability by first benchmarking with a 2D Coherent Synchrotron Radiation (CSR) model developed by the PI for a non-evolving beam. On the theoretic-

cal side, we have also extended the CSR model into 3D.

In conjunction with the code development, we have also characterized the new high order field solver. The full dispersion relation of the PIC code based on the Yee solver (the most widely used 2nd order electromagnetic solver) and our high order solver has been derived. To the best of our knowledge, this is the first time a full dispersion relation has been derived faithfully from the underlying numerical PIC model. In this process, we have identified several key understandings of the PIC dispersion relationship and origins of numerical instabilities that differentiate our results from those previous efforts and textbook analysis (which is derived for electrostatic PIC model only). We have also developed a reliable numerical tool to solve for all possible roots from the dispersion relationship, which enables us to pinpoint the conditions when numerical instabilities can arise or be suppressed. The detailed analysis of the finite grid instability has been carried out and we are extending this analysis to numerical Cherenkov instability. The summer student Michael Meyers from UCLA is the major contributor to this work and a manuscript by him will be submitted in the coming weeks. This will be his first academic paper.

The third area of our work is in the understanding of the numerical noise in the electromagnetic PIC model relevant to the simulation study of the Coherent Synchrotron Radiation (CSR) micro-bunching instability, collisionless shock and fast ignition. This work is lead by LANL postdoc Austin Yi and has been focused on wakefield and numerical Cherenkov noise generated by a relativistic particle in PIC simulations. We have applied a quasi-static model and full-wave model for the study of single particle wake in FDTD numerical medium. We have also studied how numerical Cherenkov noise is affected by simulation parameters in a simple FDTD model. Through such study, we believe that numerical Cherenkov noise is due to the non-ideal FDTD dispersion and not from resonance interaction between the relativistic particle and the FDTD grid as commonly assumed. This understanding will be further tested and corroborated in more detailed study.

Future Work

- Finish the benchmark of high order PIC code with the 2D Coherent Synchrotron Radiation model. Validate the optimal tuning parameters suitable for the micro-bunching instability study and conduct self-consistent simulation study relevant to experiment parameters.
- Extend our new numerical instability analysis to numerical Cherenkov instability and possibly other instabilities existed in current PIC model. Document such findings in peer-reviewed journal.

Study and confirm the mechanism of particle noise in PIC due to electromagnetic Cherenkov type radiation. Explore noise control strategy in the high order PIC based on such new understanding. Apply such knowledge and strategy to collisionless shock and fast ignition study to demonstrate the benefit.

The final goal for the next 12 months and the whole project is to obtain thorough understanding of the numerical instabilities and noise of the PIC model for relativistic beam and plasma modeling, to fully characterize the new high order field solver, and to identify the optimal tuning parameters and the strategy of noise control for the micro-bunching instability, collisionless shock and fast ignition study. By the end of this project, an improved PIC modeling capability will be developed and validated. We expect at least one peer-reviewed publication and possible more for the work in the next 12 months.

Conclusion

The technical goal of our work will be a validated new PIC capability that can be effectively applied to relativistic beam and plasma problems with superior accuracy and stability for a wide range of parameters. The scientific goal is a detailed understanding that bridges the gap between present simulations and theories/models for the micro-bunching instability and collisionless particle acceleration/deceleration processes. Our results will impact the design of the MaRIE X-ray free electron laser, fast ignition inertial fusion experiments and help elucidate the origin of energetic particle in the cosmos.

Publications

Huang, C., T. J. T. Kwan, and B. E. Carlsten. Synchrotron Radiation Near Field In 3D. 2014. In 25th Particle Accelerator Conference. (Pasadena, 30 Sept. - 4 Oct. 2013). , p. 487. Pasadena: JACoW.org.

Meyers, M. D., C. K. Huang, Y. Zeng, S. A. Yi, and B. J. Albright. On the numerical dispersion of electromagnetic Particle-In-Cell code : finite grid instability. 2014. arXiv online e-print service

Nuclear and Particle Futures

Early Career Research
Continuing Project

Answer to Heavy Element Production Puzzle by Measuring Neutron-induced Charged Particles at LANSCE

Hye Young Lee
20130758ECR

Introduction

This project is to build a new capability of measuring neutron-induced charged particle reactions at Los Alamos Neutron Science Center (LANSCE). Neutron-induced charged-particle reactions are critical to understand the currently unsolved heavy-element production puzzle, since these reactions in stars compete with neutron capture reactions, a main process to produce heavy elements. Of importance, the $\text{Ne-22}(a,n)\text{Mg-25}$ reaction has been studied for decades to provide a key answer to how the neutron source was generated for successive captures in heavy element production. However, the direct measurements contain large uncertainty due to the technical difficulties in detecting low cross-section reactions and large background. Using this new capability, a time-reversed $\text{Mg-25}(n,a)$ measurement at LANSCE will shed a new light on the critical region of interest to help astrophysics modelers explain how heavy elements are produced.

Developing the efficient detection system, waveform digitizers, and low background environment is the integral part of this project. Along the experimental effort, it is planned to study reaction processes using the Monte Carlo Hauser-Feshbach method, which was developed by the T-2 group. We have been collaborating to improve the theoretical prediction power by comparing the calculations with the experimental data, and this new capability will certainly enhance the reliability of theoretical predictions for currently unavailable reactions-impossible to measure in laboratories due to very short lifetime of nuclei.

Benefit to National Security Missions

Neutron-induced charged particle reactions are important to the Weapons Program for the interpretation of radiochemical diagnostics, nuclear forensics, and other applications. Scientifically, this project is well-matched to ongoing Los Alamos Neutron Science Center (LANSCE) efforts to increase our portfolio and capabilities in

nuclear astrophysics, while developing instrumentation that can address outstanding problems for multiple sponsors. This combination of world-class basic science while simultaneously solving problems for the nation in multiple nuclear science thrusts makes this truly a LANL-appropriate endeavor.

Progress

Hardware

The vacuum chamber is designed to house the ionization chamber and in the process of getting machined.

The ionization chamber's dimensions have been determined using the Monte Carlo simulation to optimize the charged-particle detection efficiency. The detector material and structure have been selected to minimize neutron-beam induced backgrounds. For the high energy detection, a double-sided silicon detector has been selected to add, so we have to submit the procurement order and the company will ship the detector, which is already assembled and tested, once the order is received.

Software

The digitizers which were purchased last year have been tested for the data acquisition (DAQ) development for this project. We tested the speed, the throughput rate, and the stability of digitizers. Stand-Alone company provided a DAQ system that has been investigated. We are working on integrating it to the existing fast DAQ home-built system. Monte Carlo simulations of the experimental system have been developed to compare with upcoming data.

Experiments

The commissioning of the detector is planned to be done with the alpha source and neutron-beams this run cycle. The beam time proposal for (n,a) reactions on the Cobalt target and the Magnesium-25 target is submitted to the Program Advisor Committee at LANSCE.

Future Work

For the third year, the detector system is planned to be commissioned with beams and used to take data to explain the questions regarding a neutron production in s process.

Integrating the hardware and software is one of the goals this year and in-beam measurements on a cobalt target will provide the limits of this new detection system.

The (n,a) reaction on the Magnesium-25 is planned in this run cycle.

Monte Carlo simulations of the experimental system have been developed to compare with the upcoming data. The data that will be taken at WNR and LANSCE will be used to deduce (n,a) cross sections.

A couple of presentations on the current work are scheduled this year.

Conclusion

We expect to produce reliable neutron-induced charged-particle reaction data by developing the experimental capability at LANSCE. The new detection system consists of highly segmented silicon detectors for a large detection coverage with good angular information and waveform digitizers with improved timing resolution. Implementing software filters in digitized waveforms, which is traditional, can provide additional information for improving resolution and performance of detectors. The combination of two techniques allows us to improve the signal-to-background ratio, pushing the current limitation on detecting low energy charged particles to lower energy than the previously achieved.

Publications

Lee, H. Y.. Neutron-induced Reactions Nuclear Astrophysics. Invited presentation at Joint DNP Town Meetings on Nuclear Structure and Nuclear Astrophysics. (Texas A&M University, 21-23 Aug. 2014).

Effects and Mitigation of Hot Electrons in Direct Drive Implosions

Natalia S. Vinyard
20140575ECR

Introduction

National Ignition Facility (NIF) provides a unique experimental platform to support stockpile stewardship, study high energy density physics, and advance our ultimate goal of inertial fusion energy. With NIF's current configuration, efficiently utilizing available power is of crucial importance for investigating strong-shock regimes. Laser Direct Drive (DD) concept, extensively employed by LANL at both the Laboratory for Laser Energetics Omega Facility and NIF, can provide a superior experimental platform by allowing ~ 7 times more energy to be coupled directly to the capsule compared to indirect drive. However, for DD experiments to be valuable to the Laboratory's primary mission, it is crucial to understand the subtleties of DD, such as the impact of kinetic effects, particularly if the modeling is done with rad-hydro codes. For example, recent DD implosions on NIF show a bright band of self-emission around the capsule equator which was neither replicated in simulations nor seen at lower laser intensities ($I_0 < 10^{15}$ W/cm²). At the same time, hard x-rays emission (hot electrons' signature) occurred predominantly around the equator. Understanding these laser-driven kinetic effects have the potential to impact heat transport and burn models in Complex codes and have consequences for the DD intensity limit. Managing these issues requires a detailed knowledge of hot electron evolution under realistic DD conditions. While recently there have been great strides taken in understanding supra-thermal electron dynamics, to-date there has not been a detailed assessment of its impact nor means of mitigation for Polar DD (PDD).

Therefore, the research objective is to investigate the generation, dynamics and impact of hot electrons on the heat transport under PDD with intent to develop a better heat conduction model and use it to explore possible mitigation schemes. This research will advance predictive capabilities of our hydro codes, thereby improving the effectiveness of future experiments.

Benefit to National Security Missions

Conducting high-profile cutting-edge experiments on the National Ignition Facility dictates that we accurately predict each experiment's performance to quantitatively assess its scientific impact. Meanwhile, understanding the nuances of Polar Direct Drive (PDD) allows us to develop experiments that are better aligned with the core mission of the Laboratory and have greater impact on Stockpile Stewardship. In particular, for PDD, this requires detailed knowledge of energy transfer from the laser to the target as well as heat transport within the target which is comprised of thermal diffusion, dominated by the background material properties, and energy carried by the hot electrons. To do this it is imperative to understand the physical processes that drive hot electron evolution, from generation through transport to deposition under the direct-drive conditions. The objective of this research proposal is to develop a better heat conduction model incorporating hot electron effects and use it to explore possible mitigation schemes. This work will have impact on burn and transport models in our rad-hydro codes therefore improving their predictive capabilities. Moreover, if this research discovers that non-linear effects play a large role in the PDD capsule implosions, particularly at high laser intensities, it can have serious implications for PDD ignitions efforts.

Progress

The project is due to start on 9/1/2014, which was after this call. Thus, progress for the last month of FY13 will be documented in the next data sheet.

Future Work

The first part of the project will examine the processes that result in hot electron creation under the conditions relevant to Polar Direct Drive (PDD) implosions and assess how global implosion parameters are affecting their evolution. Starting with the Defect Induced Mix Experiment (DIME) PDD design, simulations using HYDRA code

will be performed to help identify the relevant global laser and plasma parameters, such as intensity, density, pressure and temperature. The simulations will be done in 2D to account for polar variations in the PDD laser drive. The results of these simulations will be carefully compared to the observed data from DIME's campaigns. Next, we will concentrate on implosion conditions at a few polar points around the capsule with different laser illumination and absorption characteristics. We will extract these 1D radial profiles and use them as the initial value input parameters to VPIC code simulations to study the evolution of hot electron distribution function. A very detailed work already has been done for Stimulated Raman Scattering (SRS) hot electron generation under indirect-drive conditions using VPIC. We plan to work closely with Dr. Albright, who is an expert in this area, to examine its applicability to the direct drive case. Moreover, since the dominant laser-plasma interactions that generate hot electrons in directly drive capsules are considered to be Two-Plasmon Decay (TPD), we will utilize recent progress on this topic to investigate the resultant hot electron distribution function through 1D VPIC simulations. The team will also apply their background in analytical kinetic theory, particularly the treatment of hot electrons, and rely on the historic, as well as latest development of this subject, to study the evolution of the hot electron dynamics.

Conclusion

Conducting cutting-edge experiments on the National Ignition Facility dictates that we accurately predict experiment's performance to assess its scientific impact. Meanwhile, understanding nuances of Polar-Direct-Drive (PDD) allows us to develop experiments that are better aligned with Laboratory's mission. Predicting behavior of hot electrons during PDD implosions is crucial to advancing our knowledge of heat transport that will have impact on burn models in our rad-hydro codes. We will develop in-situ heat conduction model that incorporates effects of hot electrons, detailed knowledge preheat and possibly viable means to mitigate this problem. This model could be exported to other codes if desired.

Microscopic Fission Model for Data Needs

Ionel Stetcu
20140581ECR

Introduction

The current project is motivated by both basic-science needs and applications to new signatures for material detection, proliferation and forensics. The development of new detection capabilities such as the time-projection chamber or SPIDER (Spectrometer for ion detection in fission research) is complemented by an equally important theoretical modeling effort, leading to updates in the state-of-the-art U.S. ENDF/B-VII.1 evaluated library that is used in applications. This project aims at complementing planned experiments at LANSCE (Los Alamos Neutron Science Center) by providing reliable modeling for relevant fission quantities (fission fragment yields, kinetic energy distribution). We will also obtain information about other quantities about which only indirect experimental information can be inferred (angular momentum of the fission fragments, excitation energy sharing between fragments). Hence, once implemented and tested, it will constitute a powerful tool in fission research.

For the execution of the project, we will make use of the latest-generation supercomputers to implement and study nuclear fission of actinides in the density functional theory (DFT) framework. DFT is the only microscopic approach currently feasible for heavy nuclei, and has the additional advantage of being able to treat on the same footing the isolated nuclear system and the interaction and response in time of a nucleus with external probes (e.g., incoming neutrons, photons, etc). In the current project, we will stretch the nucleus close to the breaking point, release it, and follow the dynamics of fission. Such calculations require extensive computational resources, as one has to solve tens to hundreds of thousands of time-dependent non-linear coupled three-dimensional partial differential equations and the developed software represents a true quantitative jump (it is at least a factor of a 1000 to 2000 more complex than that of the “nearest” competition). Because of its complexity, this software represents a first step toward exascale computing.

Benefit to National Security Missions

The successful completion of this project will contribute to our ability to provide reliable nuclear reaction data for both basic and applied physics need in direct support of the nuclear security mission. In particular, the principal investigator is working on fission simulations using the T-2 developed code CGMF (cascade gamma multiplicity for fission), which provides a description of the prompt neutron and gamma properties. Their understanding is essential for developing new signatures for nuclear material detection, nuclear proliferation, forensics and energy generation, which are at the very core mission of the laboratory and NNSA. More reliable input provided by this work will lead to more reliable predictions. Finally, given the planned experimental studies at the Los Alamos Neutron Science Center (LANSCE), a successful project will allow the development of an important capability at Los Alamos National Laboratory in both fundamental and applied nuclear physics, and it will complement the current experimental program.

Progress

Although the project started only in March, I am on track to have a working code on graphical processing units (GPUs) by the end of the calendar year (2014). All the routines have been already converted to work on GPUs and at this point I am in the testing and debugging phase. By the end of 2014 I will be also able to provide a detailed study of the speed improvement of the new implementation vs. the existing working one. Very promising results have been already obtained for the part of the code already tested.

On the Titan supercomputer at ORNL I was able to achieve 15-20 speedup factors for large-scale calculations over the classical implementation without GPU's. Given that all the required communication in the GPU implementation is done in the part already tested, it is possible that even better speedup factors can be obtained once the full code is rewritten. This will indeed

allow me to perform very large scale simulations, which are essential for the simulation of the fission process.

Future Work

In the next year, I will continue the implementation of the code on GPUs (graphical processing units). I will test the current implementation against the existing version based on message passing interface (MPI), and compare the speedup due to the use of accelerators. I will also implement a procedure (so called “quantum cooling”) in order to obtain the ground state of a nuclear system using the current code, and start the first simulations of fission by stretching a ^{240}Pu nucleus. At the beginning most of the tests are going to be performed in smaller boxes, to establish the parameters that would allow a calculation of fission properties. Once the parameters are fixed, I will perform larger simulations in which the initial nucleus will be placed in a very large box, that would allow the formation and evolution of the two fission fragments, which repel each other via Coulomb.

Conclusion

The main goal of the current project is to provide a first fully quantum-mechanical description of nuclear fission, the physics process in which a heavy nucleus breaks apart. Our approach can provide a reliable method to extract fission properties that can be later used as input in simulations with applications to energy generation, global security, weapons, astrophysics. We plan to obtain fission yields in charge, mass, kinetic energy and angular momentum, and to study the properties of neutrons emitted during the breakup. Selected results will be tested against experimental data and predictions of other theoretical developments in our group.

Gating and Emission Enhancement of Diamond Field-Emitter Arrays

Heather L. Andrews
20120522ECR

Abstract

All devices that use beams of electrons, ranging from displays and vacuum electronics to electron microscopes and free-electron lasers, will benefit from the development of sources of electrons, called cathodes, that are more robust, have longer lifetime and produce higher quality electron beams. A novel type of cathode called a Diamond Field-Emitter Array (DFEA) has shown great promise as a cathode that could deliver cutting-edge quality beams with revolutionary increases in robustness and lifetime. Such a device could potentially enable new classes of microwave tubes (used everywhere from microwave ovens to power sources for accelerators) and lead to a newer, simpler, and more compact architecture for high-power free-electron laser weapon systems for DoD.

DFEAs have been characterized only in a limited, unrealistic configuration, and further testing is needed to prove their promise in real-world operating conditions. The goal of this work is to test DFEAs under real-world operating conditions. The results of this work indicate that DFEAs perform better under real-world conditions than expected. This is a very encouraging finding that will be used to pursue further external funding.

Background and Research Objectives

All devices that rely on an electron beam (e.g. communication technologies, radar, research equipment) stand to be improved by increased electron beam quality, increased cathode robustness, and increased cathode lifetime. Such advances could reduce the cost and extend the life of communications satellites, lead to thinner, lighter, and more energy efficient electronic displays, allow for low power, miniaturized versions of lab equipment such as THz sources and scanning electron microscopes, or greatly simplify electron guns for accelerators and free-electron lasers (FELs). Diamond field-emitter arrays, (DFEAs) [1], arrays of exquisitely sharp diamond pyramids, have many advantages compared with other

cathode choices in beam quality, robustness, and lifetime.

All three cathode types, thermionic, photo-, and field-emission cathodes, have advantages and disadvantages depending on the application. Thermionic cathodes, where a hot cathode element emits electrons, are the most broadly used across all applications. They produce electron beams that are very bright but have slow response time and must be gated. Our application of interest, high-power FELs, requires a simultaneously high brightness and high peak current density (usually short pulse) beam. In order to obtain the necessary current density, the beam from a thermionic cathode must be manipulated to such a degree that the high brightness of the original beam is destroyed. This problem has led to extensive development of photocathodes.

Photocathodes operate on the photoelectric effect; light impinging on a material produces electrons. The materials available to use as photocathodes range from pure metals to semiconductors. In general photoemission produces high current density beams, which require no downstream manipulation, but which have lower initial brightness than thermionic cathodes. Metal photocathodes typically are reliable and robust, but have low quantum efficiency and place unrealistic requirements on practical drive laser systems. The Alkali-coated semiconductor photocathodes have fairly high quantum efficiency, but are extremely sensitive to contamination and require ultra-high vacuum conditions throughout preparation, transfer to the injector, and during operation. The disadvantage of all photocathodes is the need for a powerful drive laser system. In the case of superconducting RF electron injectors, this is a concern because the excess laser energy deposited on the cathode could locally heat the gun.

Field emission cathodes are fundamentally simpler to engineer than thermionic and photocathodes, but they have historically been poor cathode candidates. Metal

[2] and silicon [3] field-emitter arrays (FEAs) are typically characterized by difficulties such as high turn-on electric field, and low, unstable emitted current [2,3]. The Spindt cathode, an array of sharp conductive emitters, has shown high current density operation with reasonable beam quality [4]. Though these cathodes demonstrate stable emission at low per-tip currents, they become unstable at high per-tip currents and arrays larger than one millimeter on a side have not operated reliably [4]. Other problems associated with metal FEAs are catastrophic failure at high current operation and non-uniform emission over a large array, which together preclude the wide adoption of traditional FEAs.

DFEAs, shown in Figure 1, were first fabricated at Vanderbilt University several years ago [5]. They are formed using a mold-transfer process, patented by Vanderbilt but now used in labs around the world, in which CVD nano-diamond is deposited into sharpened silicon molds [6]. Because this technique uses standard silicon wafer processes to pattern the array, they can be formed with a very wide range of base length, pitches, and can be created with 1,2, or 4 peaks per pyramid. Though the basic process of DFEA fabrication is well established, the details of how to reliably obtain high quality samples are quite complicated and are still under development. DFEAs are robust to exposure to air, emit in poor or good vacuum conditions, and can be easily conditioned to emit uniformly over the whole array [7]. Because the tips are diamond they are chemically inert and have excellent thermal properties, characteristics critical to sustain high per-tip emission current without catastrophic failure modes.

A direct numerical comparison of beam brightness (beam density in six-dimensional phase space) or even emittance (beam density in two- or four- dimensional phase space) from each type of cathode is extremely difficult due to variations between experiments that impact the measurement. In general, photocathode emittance ranges from 0.4 mm-mrad at very low current to 1.2 mm-mrad at high current [8]. Typical thermionic cathode emittance, after beam manipulation, is around 30 mm-mrad [9], and in this case the current is still much lower than future FEL requirements. The upper limit of measured DFEA emittance is 1 mm-mrad [10], comparable to photocathode emittance for high current operation. Photocathodes typically can produce 100 A/cm² current density, while DFEAs are expected to produce >100 A/cm² when a reasonable single tip current is extrapolated to an entire array. The most significant difference between photocathodes and DFEAs is that DFEAs have been demonstrated to operate in vacuum conditions 5 orders of magnitude worse than what is required by photocathodes. Innovative laser gating of a

DFEA could result in a cathode that is comparable in performance to a photocathode with vastly increased robustness and lifetime that can greatly reduce engineering and vacuum constraints on the injector, eliminate or simplify the drive laser system, and is completely compatible with superconducting RF cavities.

The research goals for this project are to characterize DFEA emission under realistic operating conditions. DFEAs are poised as a high-brightness cathode breakthrough technology. They have undergone enough ad-hoc characterization to show great promise as sources of high-brightness, high-current density electron beams [11], but the work to date has been limited by available test equipment, not the DFEAs themselves. Thus far they have only been tested in a “close-diode” configuration, in which the cathode is planar to the anode, but spaced only about 200 μm away. There are a few problems with this configuration. First, it is extremely hard to determine the vacuum level in the anode-cathode gap when the gap is so small. This is problematic because it is quite desirable to understand if performance depends on vacuum level. Next, when the anode and cathode are so close, the power of the emitted electron beam lands in a very small area on the anode, and can do significant damage. Finally, any material that leaves the anode as a result of high current damage will end up back on the cathode, likely hurting cathode performance and shortening cathode life.

In this work, the test chamber was designed so that the cathode and anode would be spaced far enough apart to allow for accurate vacuum measurement, and also allow space for the beam to spread out and dissipate the power density delivered on the anode. We have measured lower cathode turn-on fields, as well as higher than expected per-tip currents. While these results are far from comprehensive, they indicate that DFEAs may perform better under real-world conditions than under the close-diode configuration.

Scientific Approach and Accomplishments

We have tested DFEA cathodes in a configuration much closer to real world operating conditions than previous experiments. The most profound results are lower turn-on voltages and higher per-tip emission currents than expected. These results hold across multiple samples, as well as for two different array densities.

The first achievement in this project was designing, building, and commissioning a new test chamber. Most of the first year was spent on this task, with the chamber successfully commissioned in August 2012. This chamber system includes equipment to allow for either very poor or very good vacuum, and to measure the background gas constit-

uents. It also includes equipment to allow precise adjustment of the anode-cathode gap for control of the applied field. Finally, the chamber system design is highly flexible, allowing for the possibility of a wide range of future experiment to be conducted.

Shortly after the chamber was completed, the first cathode samples were tested. The cathodes are tested at a low vacuum level of approximately 1×10^{-8} Torr (10 orders of magnitude lower pressure than atmosphere). The cathode and anode are arranged in a parallel configuration with variable gap. The anode for all experiments is a visually transparent phosphor that images the emitted electron beams while allowing the cathode and holder to be seen as well. Figure 2 shows the cathode holder with mounted DFEA cathode as well as the emitted beam imaged on the phosphor screen. A positive DC power supply is connected to the phosphor anode, while the cathode is connected to ground through a resistor of known value. Measuring the voltage drop across this resistor allows calculation of the current emitted from the cathode.

A total of four cathodes are tested in this arrangement. Three of the samples are arrays of large base pyramids (25 micrometers base length), 5 pyramids on a side with 500 or 1000 micrometer spacing, while one sample is composed of large base pyramids densely spaced at 4 micrometers apart and cut to a one-half centimeter diameter circle. The arrays appear in the middle of a diamond film that is brazed to a Molybdenum substrate for rigidity. The cathodes were mounted in a holder the connected to a precision actuator so that the cathode-anode spacing could be easily and accurately adjusted. For most experiments the DC power supply was set to 35,000 or 40,000 Volts, and the field experienced by the cathode was adjusted by varying the gap between the anode and cathode. Typical gap values range from 6 to 3 millimeters.

Figure 3 shows a typical result from this work. This plot displays the emitted current from a DFEA as a function of the applied field. The results show a consistent turn-on voltage of around 5 megavolts per meter, which is low compared to typical field emitter arrays. The data also show a maximum per tip current of around 18 microamperes per tip, which is comparable to the highest per-tip current ever measured for DFEAs. Such currents were not expected from these arrays because similar samples produced far less current in the “close-diode” configuration. This suggests that the large anode-cathode gap arrangement is favorable to DFEA performance.

The data from this project is currently being used in two follow-on proposals, and is the subject of one publication. To date, no accepted publications or funded proposals

have been realized.

Impact on National Missions

DFEAs present not only interesting fundamental science, they offer an alternative to many of the drawbacks existing cathode technologies demonstrate. DFEA cathodes continue to be promising for accelerator applications, as we have demonstrated their performance and robustness under conditions similar to accelerator electron guns. It is the intent of the investigators to pursue the development of DFEAs as electron sources for many mission-critical applications ranging from accelerators and free-electron lasers, to satellites and terahertz devices.

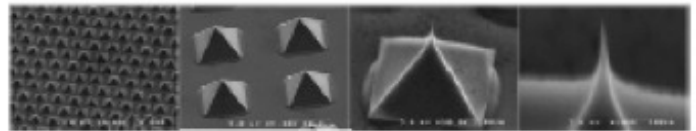

Figure 1. A diamond field-emitter array shown at various scanning electron microscope magnifications with detail of the sharp pyramid tips.

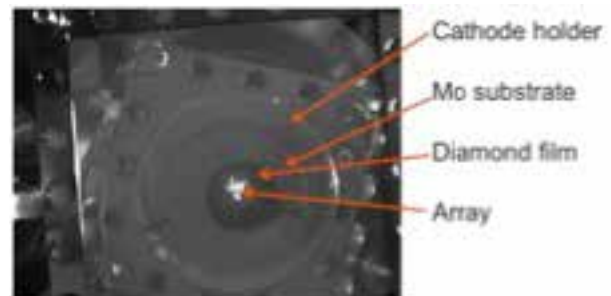

Figure 2. DFEA cathode and holder visible through transparent phosphor anode. Bright pattern is array emission made visible by the phosphor.

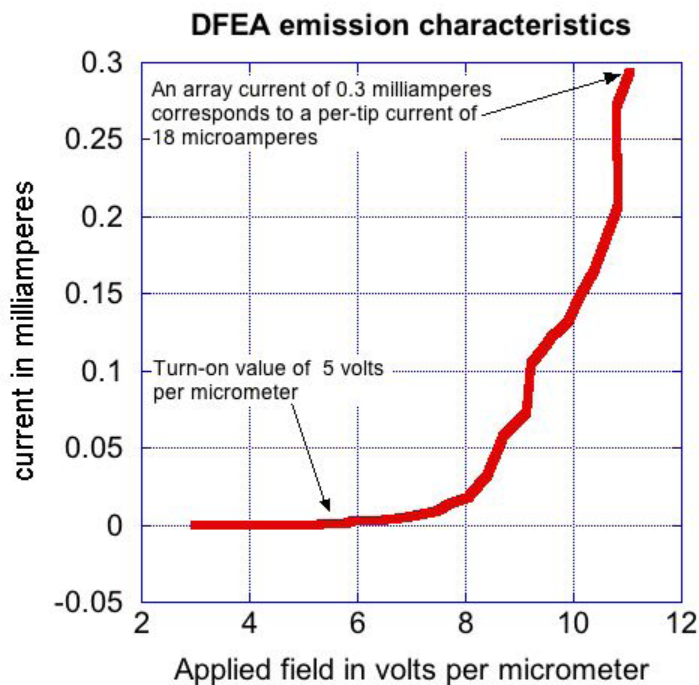

Figure 3. DFEA emission current as a function of applied field with turn-on field and maximum observed current noted.

References

- Kang, W. P., A. Wisitsora-at, J. L. Davidson, and D. V. Kerns. Ultralow-voltage boron-doped diamond field emitter vacuum diode. 1998. IEEE ELECTRON DEVICE LETTERS. 19 (10): 379.
- SPINDT, C. A.. A THIN-FILM FIELD-EMISSION CATHODE. 1968. JOURNAL OF APPLIED PHYSICS. 39 (7): 3504.
- LI, Q., M. Y. YUAN, W. P. KANG, S. H. TANG, J. F. XU, D. ZHANG, and J. L. WU. FABRICATION AND CHARACTERIZATION OF SILICON FIELD-EMISSION DIODES AND TRIODES. 1994. JOURNAL OF VACUUM SCIENCE & TECHNOLOGY B. 12 (2): 676.
- Schwoebel, P. R., C. A. Spindt, and C. E. Holland. High current, high current density field emitter array cathodes. 2005. JOURNAL OF VACUUM SCIENCE & TECHNOLOGY B. 23 (2): 691.
- Kang, W. P., J. L. Davidson, M. Howell, B. Bhuvu, D. L. Kinser, Q. Li, and J. F. Xu. Micro-patterned polycrystalline diamond field emitter diode arrays. 1995. In Vacuum Microelectronics Conference, IVMC. (Portland, OR, July 1995). , p. 287. Portland, OR: Technical Digest.
- Kang, W. P., J. L. Davidson, M. Howell, B. Bhuvu, D. L. Kinser, D. V. Kerns, Q. Li, and J. F. Xu. Micropatterned polycrystalline diamond field emitter vacuum diode arrays. 1996. JOURNAL OF VACUUM SCIENCE & TECHNOLOGY B. 14 (3): 2068.
- Jarvis, J. D., H. L. Andrews, C. A. Brau, B. K. Choi, J. Davidson, W. P. Kang, and Y. M. Wong. Uniformity conditioning of diamond field emitter arrays. 2009. JOURNAL OF VACUUM SCIENCE & TECHNOLOGY B. 27 (5): 2264.
- Power, J. G.. Overview of Photoinjectors. 2010. ADVANCED ACCELERATOR CONCEPTS. 1299: 20.
- BAKKER, R. J., C. A. J. VANDERGEER, A. F. G. VANDERMEER, P. W. VANAMERSFOORT, W. A. GILLESPIE, and G. SAXON. 1 GHZ MODULATION OF A HIGH-CURRENT ELECTRON-GUN. 1991. NUCLEAR INSTRUMENTS & METHODS IN PHYSICS RESEARCH SECTION A-ACCELERATORS SPECTROMETERS DETECTORS AND ASSOCIATED EQUIPMENT. 307 (2-3): 543.
- Jarvis, J. D., H. L. Andrews, B. Ivanov, C. L. Stewart, N. de Jonge, E. C. Heeres, W. P. Kang, Y. M. Wong, J. L. Davidson, and C. A. Brau. Resonant tunneling and extreme brightness from diamond field emitters and carbon nanotubes. 2010. JOURNAL OF APPLIED PHYSICS. 108 (9): -.
- Jarvis, J. D., H. L. Andrews, C. A. Brau, B. K. Choi, J. Davidson, B. Ivanov, W. P. Kang, C. L. Stewart, and Y. M. Wong. Field-Emission Cathodes for Free-Electron Lasers. 2009. In 31st International Free-Electron Laser Conference. (Liverpool, UK, August 2009). , p. weoa04. Liverpool, UK: CERN.

Nuclear and Particle Futures

Early Career Research
Final Report

Enabling Temporal and Spatial Shaping of Ultra-Intense Laser Pulses for Next-Generation, Compact Particle and Radiation Sources

Rahul C. Shah
20120721ECR

Abstract

Modern laser pulses provide remarkable concentrations of electrical energy in space and time. Electric fields orders of magnitude over those of conventional power systems are routinely achieved and offer the promise of a new generation of particle accelerators producing unique ultra-shot particle bursts. The importance, with respect to the work of Los Alamos National Laboratory (LANL), of such a technological advance stems from the need for particles sources as a means to create and probe material states. The ultra-fast time scale of the sources provides hitherto unavailable resolution when used as a probe and is also essential to enabling the creation of unique material conditions informative to the testing of our models.

Leading up to this project, both simulations and physical grounds had suggested that new capabilities to control specific details of the laser electric field distribution would enhance the performance of these new particle accelerators. In particular, simulations in which a tailored sharp temporal rise and flattened spatial profile were used for the input laser field led to new control over accelerated particle divergence and energy spread. Such control over the particles would significantly enhance applications to probing and synthesizing conditions of interest to our mission.

Over the course of this project we investigated numerous approaches to manipulate, in both space and time, the driving high power electric field distribution of the intense laser pulse. We generally found that efforts to impose control over the incident light pulse resulted in undesired instabilities or difficult to manage performance fluctuations. However, a distinct tack of favoring the natural restructuring of matter and light, which occurs during the intense laser-matter interaction, resulted in remarkable new control of accelerated particle properties. Highlighting the most important experimental result, we have for the first time combined high energy,

narrow spectrum, and high efficiency from a laser-based ion accelerator. Using LANL's computational capabilities for particle-in-cell simulation, we interpret the unique experimentally measured features to result from self-forming structures in the laser field and plasma (channeling and resulting magnetic field localization) that occur with initially nm scale metal targets. The newly identified mechanisms may lead to further optimizations. The new accelerated properties are valuable for the pump and probe applications of the energetic, short-pulse particles.

Background and Research Objectives

Laser-based particle accelerators capitalize on the ability to localize energy in space and time at scales unimaginable with conventional systems. Modest amounts of laser energy are routinely squeezed into bursts less than 1 picosecond ($1 \text{ ps} = 1 \text{ part in } 1 \text{ trillion of a second}$) and as a result, for that brief instant, powers reach the order of the entire national electrical grid. The energy is also focused spatially so as to produce energy densities which push electrons to near light speed within every oscillation of the light field. In the interaction of these light pulses with ionized atoms, or plasma, electric fields orders of magnitudes greater than those of conventional accelerators create ultra-short bursts of high-energy electrons and ions.

Such ultra-short bursts of particles offer a unique capability to both create and study material regimes of interest. For example, one application is the generation of short neutron bursts, used to probe dense material. In this case, the neutrons are generated as secondary products from the nuclear reactions between accelerated ions and a converter material. There can be important information gained by using such a source with ps scale bursts as opposed to more conventional devices operating on the ns time scale. As mentioned, laser-based accelerators also provide a unique ability to synthesize conditions – or as is commonly stated, to act as a pump

that excites a specific condition. A current project at LANL is studying the interface integrity between two materials that have been heated at a rate faster than the hydrodynamic disassembly. Such extreme conditions cannot be achieved with conventional, longer bursts of energetic ions. In both cases, as a probe or as pump, the current status of the particle sources will benefit from increased efficiency, directionality, and spectral control.

One path to improving such essential aspects of the particle beams involves the details of the spatial and temporal distribution of the laser's optical fields. In time, the pulse cannot by routine means be made arbitrarily sharp or steep because of limitations in the bandwidth of the laser system (high bandwidth is required for sharp features). In the transverse dimension of the laser focus, light will naturally form a centrally peaked distribution. However, simulations done at LANL, which imposed a fast rise and flat focus, showed collimation of the particles as well as spectral control. Furthermore, an ability to create sharp rises could enable recent theoretical work showing electron sheet production from a thin foil. Such electron sheets have been proposed as the basis of new short wavelength coherent radiation sources- yet another application of interest.

The objectives of the grant were to identify and study techniques for time and space shaping of the driving laser light field that create advantageous accelerated particle properties. In the broadest terms, we studied involved techniques to control the laser pulse prior to its interaction with the target of interest as well as approaches designed to create new energy distributions within the target interaction. The approaches designed to control the high power laser prior to target interaction were found to suffer from instability and fluctuation. However, we found remarkable success in the latter approach for which the choice of target encouraged natural non-linear evolution of the light-matter interaction to create improvements in efficiency and spectral control.

Scientific Approach and Accomplishments

We have explored spatial shaping and temporal shaping of the light energy through a variety of theoretical and experimental approaches. Initially our focus was on the explicit shaping of the time and transverse spatial profiles of the laser light prior to the interaction with the target. As an understanding developed that such an approach suffered from instabilities and fluctuations, we moved to explore different targets designed to implicitly manage the laser light distribution within the interaction. Following, the different studies are briefly described with an emphasis on the most successful accomplishments achieved using

the latter target based approach.

Explicit spatial and temporal shaping

From standard diffraction theory, the laser will form a focus that is centrally peaked. As a result, a large transverse variation in light pressure forms across the extent of the target. To address the possibility of creating a more uniform transverse light distribution, we investigated wave-front shaping as a means to approach a flat-top focus. Because large deformable mirrors as well as custom phase plates are available, a modified wave-front is conceivable either near or at the end of the laser chain in a high-power laser system.

In order to identify the necessary wave-front modification, we used an iterative optimization scheme known as a genetic algorithm. While solutions for the wave-front can be directly calculated if one allows for amplitude (mirror reflectivity variation) across the laser beam as well, such an approach would be more difficult to realize experimentally for high power laser systems. In the genetic algorithm approach, a generation of random radially varying wave-fronts is evaluated by comparing the resulting foci shapes with a desired flat-top standard. A new generation is formed which preserves the best scoring individuals in addition to allowing cross-over and mutation. Much as the case with traditional focusing, we found that each lens speed produced an optimum flat-top distribution when the flat-top dimension was matched to the diffraction limited focusing of the lens without any wave-front modification. The optimum phase front is then applied across lenses of different speeds ($f/\#$) to produce larger and smaller flat-top distributions (Figure 1).

However, our simulations of the particle acceleration, also conducted under the support of the project, showed that such a flat-top in space did not enhance the particle acceleration. A representative super-Gaussian flat-top was used to simulate the particle acceleration by using two-dimensional particle-in-cell (PIC) simulation with LANL's VPIC. In the density distribution of the target, ripples rapidly formed across the transverse dimension. These perturbations fed back into the laser energy distribution thus amplifying the degradation of the transverse profile (Figure 2). From these simulations, it became clear that a flat top in space required an accompanying fast laser rise so as to outpace the growth of the transverse instability (as had been the case in the simulations done prior to the grant). Our finding was consistent with recent experimental results suggesting the development of wavelength scale transverse break-up in similar laser-plasma interactions [1].

When it comes to the laser rise, intrinsic limitations result from the finite bandwidth of a given laser system. How-

ever, in the research leading up to this grant we had just made the first time resolved measurements of relativistic transparency, a phenomenon by which ultra-intense light turns otherwise opaque plasma transparent. This work had suggested that the onset of relativistic transparency could act as an ultra-fast shutter. To test this idea, we placed a 10 nm thin foil target 30 μm from a second thicker foil target of 50 nm. We then diagnosed the light reflected from the 2nd target to capture its instantaneous velocity in response to the light transmitted thru the first foil. Whereas in the past we had observed an initial target expansion back towards the laser due to un-modeled real laser rise, we now saw the target immediately pushed along the laser direction (as seen in simulation). This forward motion is evident from the highlighted negative slope of the temporal phase shown for both experiment and simulation in Figure 3. However, one also notes that the simulation case shows a much faster initial push with respect to the experiment (much greater slope of the temporal phase). Given that the first foil interaction is far from ideal, it is likely that, despite the temporal shaping, we obtain un-optimized intensity impinging on the 2nd foil. This technique would require an initial pulse much closer to the ideal than available to us.

The challenges we faced with an imposed spatial / temporal shaping led us to focus instead towards utilizing natural reshaping of the light energy within the target interaction.

Pulse shaping via target engineering

Our experiments with novel targets proved to be the most successful outcome of the project. The first direction pursued followed from a published simulation study showing that low-density targets could effectively act as time and space focusing elements for the focused high-power laser pulse [2]. In particular, the paper suggested that the target density should be carefully optimized to be just above the threshold allowing ordinary light to transmit (near-critical density). The intense light would pass thru via a combination of hole-boring and relativistic transparency (as described above). In this case, the transverse instabilities are dominated by the dynamics in the center of the transverse distribution where the optical energy concentrates. As the laser ionizes the target into plasma, this shaping target was termed a “plasma lens.” While the published work suggested such a target could be used as an optical component, our own 2-D PIC simulations showed that any secondary target would be severely disrupted by the interaction, well before the laser propagation thru it (Figure 4). Instead, we observed that the self-focusing and light channeling within this target itself led to unique peaks in the simulated ion spectra. Under the auspices of this project, LANL’s target fabrication group synthesized free-standing

$\sim 10 \mu\text{m}$ foils from nano-pore silica (SiO_2) foam of $\sim 20 \text{ mg/cc}$ density. These parameters had been carefully optimized from numerous simulations. In the experiments, we observed a peaking in the spectrum of accelerated O+6 ions in stark contrast with the well-known exponentially decaying spectra obtained in the laser-based ion accelerators. Understanding of the interaction and mechanisms is still being developed: this aspect of this project will continue under the auspices of LDRD 20140483ER, a project based on our initial work here involving the nano-pore, near-critical density foam targets.

A separate approach followed surreptitiously from our interest in published work related to the transverse instability, the same phenomenon that we had observed in our own simulations (see discussion above under Explicit spatial and temporal shaping). Based on theory and simulation it was claimed that multi-layered foil targets could stave off the development of transverse instabilities [3]. We obtained nm scale Aluminum targets with layers of C deposited on the surface in order to test these ideas via measurements with our unique optical diagnostics. However our attention quickly shifted to the less ambiguous results from the control case. We had in fact never before measured the performance of pure Al nano-targets. From these Al targets we observed a first-ever combination of high-energy ions, narrow spectral peaking, and high conversion efficiency (particle number). Specifically we observed the Al+11 ions to have energy peak at 165 MeV, energy spread as low as 7%, and an inferred conversion efficiency of 5% from the laser. Supported by the optical measurements, 2D PIC simulations suggest the mechanism for these exciting results initiates with a transverse self-focusing and channeling of the light pulse in the ionized and expanded Al plasma (Figure 5). The resulting electron current drives an increase in the magnetic fields at the rear surface of the target. This local magnetic field feeds back on the system causing an increase in the local electron density near the rear surface. The increased electron charge is released as the rapidly diverging laser pulse and accelerating ion population exits from the target. This enhanced electron current subsequently reshapes the ion spectrum by speeding the lagging particles and slowing the faster ones. A manuscript is being prepared for publication of these results.

Impact on National Missions

In national security science, ultra-fast particle sources provide an important tool as both a probe of fast evolving material and as a means to achieve unique states by which modeling is verified. As one example, typically deployed neutron sources acting as a probe are above the nano-second ($1 \text{ ns} = 1 \times 10^{-9} \text{ s}$) time scale whereas ps scale (1

ps = 1×10^{-12} s) resolution provides new detail of rapidly evolving material. A distinct application is the use of laser-generated ions to rapidly heat a volume of material at a timescale much shorter than that of the hydrodynamic disassembly. This project had investigated approaches by which new levels of control over the driving light field improve the performance of laser-based particle accelerators. As a result of these investigations we have observed ion acceleration that for the first time combines high energy, narrow spectrum and high efficiency. The new discovery has immediately found application in experiments requiring ions for ultra-fast heating (DR20140029DR) and has led to a follow on project (20140483ER). More broadly, the newly identified understanding opens new pathways for optimization and engineering of the laser-based particle accelerators that provide these unique ultra-short particle bursts.

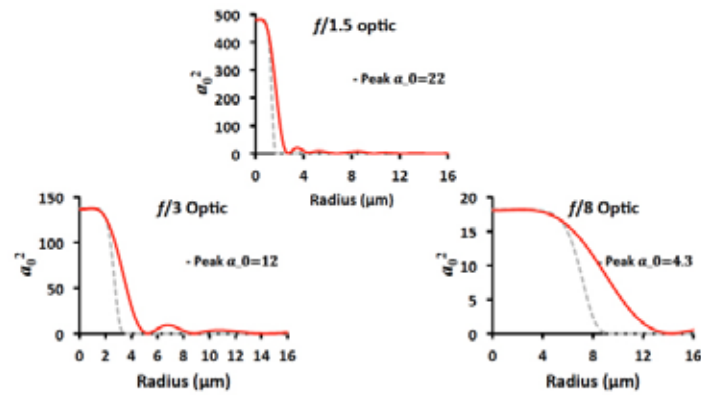

Figure 1. Calculated flat-top intensity profiles (red-solid) and target profiles (gray-dashed) for varying lens speeds.

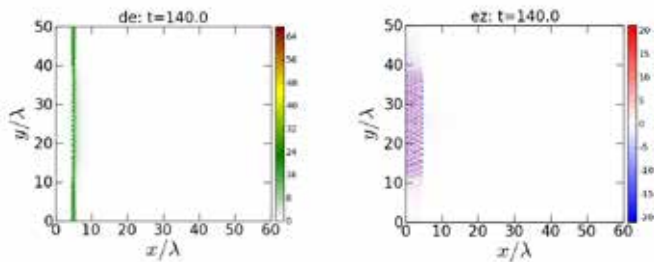

Figure 2. Snapshots from simulation with flat-top laser input showing electron density (left) and laser electric field (right).

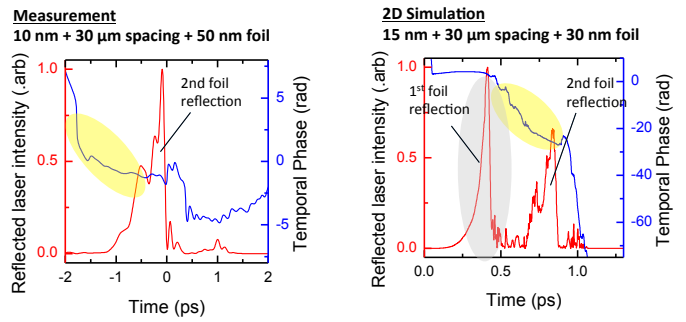

Figure 3. Experimental and simulated results for reflected light measurements from two foil interaction. Solid blue shows instantaneous temporal phase from which target velocity is extracted. Highlighted region indicates initial target movement away from laser pulse. Solid red shows intensity envelope of the reflected light.

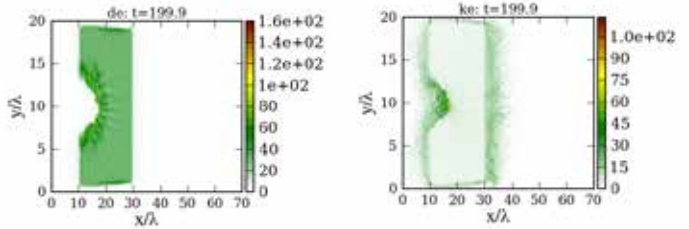

Figure 4. Simulation results for near critical density plasma. The laser propagates left to right. Left image shows electron density whereas right image shows electron kinetic energy.

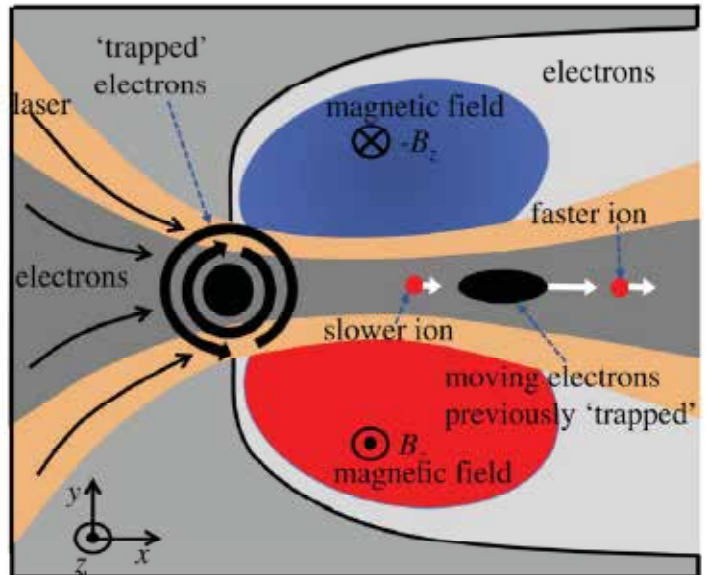

Figure 5. Schematic of quasi-monoenergetic ion beam generation from the Aluminum nano-foil targets. See text for detailed description.

References

1. Palmer, C. A., J. Schreiber, S. Nagel, N. P. Dover, C. Bellei, F. N. Beg, S. Bott, R. J. Clarke, A. E. Dangor, S. M. Hassan, P. Hilz, D. Jung, S. Kneip, S. Mangles, K. L. Lancaster, A. Rehman, A. P. L. Robinson, C. Spindloe, J. Szerypo, M. Tatarakis, M. Yeung, M. Zepf, and Z. Najmudin. Rayleigh-Taylor instability of an ultrathin foil accelerated by the radiation pressure of an intense laser. 2012. *Physical Review Letters*. 108: 225002.
2. Wang, H. Y., C. Lin, Z. M. Sheng, B. Leu, S. Zhao, Z. Y. Guo, Y. R. Lu, Y. R. Lu, X. He, J. E. Chen, and X. Q. Yan. Laser shaping of a relativistic intense, short Gaussian pulse by a plasma lens. 2011. *Physical Review Letters*. 107: 265002.
3. Qiao, B., S. Kar, M. Geissler, P. Gibbon, M. Zepf, and M. Borghesi. Dominance of radiation pressure in ion acceleration with linearly polarized pulses at intensities of 10^{21} W/cm². 2012. *Physical Review Letters*. 108: 115002.

Publications

Palaniyappan, S., C. Huang, D. C. Gautier, C. E. Hamilton, J. A. Cobble, C. Kreuzer, R. C. Shah, and J. C. Fernandez. Magnetic electron trapping generates efficient quasi-monoenergetic ion beam from laser-driven plasmas. Submitted to *Nature Physics*.

Large-Scale Simulations for Nuclei and Strongly-Correlated Matter

Stefano Gandolfi
20120758ECR

Abstract

In this project we have investigated several properties of strongly correlated many-body fermionic systems, including cold atoms and nuclear systems. We have demonstrated the accuracy of Quantum Monte Carlo methods in predicting properties of many-body systems by comparing with experimental measurements. The possibility of making accurate predictions of nuclear matter is particularly important to explore the properties of neutron stars and supernovae, as a direct experimental investigation of such extreme conditions of densities is not possible.

Background and Research Objectives

A major goal of this project was to calculate properties of nucleonic matter and neutron stars that is of great relevance for nuclear astrophysics. The equation of state and related properties including the spin- and neutrino-response are critical to understand current observations of the mass-radius relationship, the cooling and X-ray emission of neutron stars. The inhomogeneous neutron matter in the crust can be modeled by neutrons interacting via nuclear forces confined in external traps, and the higher-density homogeneous matter can also be studied through large-scale Quantum Monte Carlo simulations.

A quantitative understanding of homogeneous and inhomogeneous matter from first principles is an essential first step towards building an energy density functional for nuclei, as properly calibrated nuclear energy density functionals must capture the effects of the interaction and reproduce experimental results for any nuclear system. The characterization of nuclear energy density functionals has recently been undertaken as one of the main goals of the UNEDF and NUCLEI SciDAC projects, and is of high impact to study properties of neutron-rich nuclei that will be realized in several current and upcoming DOE experimental facilities like FRIB, CARIBU at Argonne and at GSI. Typically large nuclei and matter found in the crust of neutron stars are studied using density

functional models fit to the properties of known nuclei. These density functional theories are successful in many instances, but are less reliable when extrapolating far beyond the region where they have been constrained. For example, neutron stars contain ninety percent neutrons whereas nuclei have fifty to sixty percent neutrons. In addition, the structure of neutron stars probes nuclear densities at least several times smaller (in the crust) and several times larger (in the core) than those in nuclei.

More realistic calculations of neutron-rich matter will also impact studies and experiments on neutron-rich nuclei to be studied at rare-isotope facilities like the present-day CARIBU at ANL and the upcoming FRIB facility at Michigan State. Inhomogeneous matter is particularly important in both nuclear and cold atom physics. In nuclear physics, critical terms in the energy density functional depend upon the gradient of the nuclear density. The extreme isospin limit of these gradient terms are difficult to constrain from presently known nuclei, as are the spin-orbit splitting and pairing interactions in heavy nuclei. These terms become ever more important in approaching the more neutron-rich limit of importance in *r*-process nucleosynthesis. Similar gradient terms can be measured in atomic systems using optical traps.

We have simultaneously studied related strongly-correlated ultra-cold Fermi gases. In the dilute regime where the density is low enough, properties of neutron matter are very similar to those of ultra-cold Fermi gases near unitarity. The unitary limit of cold Fermi atoms is the most strongly-coupled system we know, as its scattering cross-section diverges. These systems are realized in experiments through the use of the Feshbach resonances; their properties are independent of the microscopic details of the interaction and are thus universal. Indeed, the unitary Fermi gas is not only of relevance for neutron matter but also for ultra-cold atoms in optical lattices, which are currently being realized experimentally in multiple laboratories around the world. Because their uni-

versality, ultra-cold Fermi gases are an ideal system to test microscopic many-body theories. Cold atoms near unitarity exhibit the largest pairing gap known as a fraction of Fermi energy, and the pairing gap in neutron matter is nearly as large. We have used Quantum Monte Carlo techniques to explore the superfluidity as a function of coupling strength in both homogeneous and inhomogeneous systems.

Dynamic properties of nucleonic matter and cold matter are also important, including neutrino scattering from nuclei. The neutrino response of nucleonic matter is critical to neutron star cooling. These properties cannot be studied in terrestrial experiments where extremely neutron-rich systems are not stable, so theoretical predictions are very important. On the other hand, understanding the interaction of neutrinos with nuclei is essential to calibrate detectors in upcoming long baseline neutrino experiments. We have investigated the neutrino interaction with light nuclei that is of relevance for the DOE Office of Science in both nuclear and particle physics. Related experimental studies of the dynamic properties of Fermi gases are advancing rapidly, and a variety of responses related to those in neutron matter can be realized. Dynamic response functions coupled to the atomic spin and to the density have already been measured, with clear prospects for future more accurate observations. These response functions directly probe the superfluid pairing and short-range correlations in cold atom systems.

Scientific Approach and Accomplishments

Because nucleons and ultra-cold Fermi gases are very strongly interacting, it is not possible to solve for the equation of state using purely mean-field techniques, and non-perturbative computational techniques are required. We have used Monte Carlo techniques based upon Feynman path integrals. Quantum Monte Carlo (QMC) techniques can be optimized to run efficiently on large-scale parallel computers and used to probe a wide variety of strongly-correlated quantum systems.

During this project we have accomplished several studies for both nuclear systems and cold atoms summarized below.

We have studied the neutrino interaction with nuclear systems. Initially we have calculated the neutral- and charge-changing electroweak currents in deuteron [1]. In this case the problem can be numerically solved exactly, and permitted us to develop the code to include both one- and two-body processes in the electroweak currents. We have also made particular attention to the role of the initial and final state in the calculation. After this preliminary step, we have applied the electroweak operators to calculate the electromagnetic and electroweak sum rules in Carbon

12 using the Green's Function Monte Carlo method. The results have been summarized in two papers [2,3], where we show that the contribution given by the two-body processes and the interference between one- and two-body processes is particularly important in studying these processes.

We have then focused to the neutrino interactions in dense neutron matter, and its effect to the neutron star cooling. We have calculated selected spin-response sum rules using the Auxiliary Field Diffusion Monte Carlo, and the two neutron spin-response in a periodic box. Using the two-body response function and the sum rules we have constrained the full spin-response in pure neutron matter, that is directly related to the neutrino mean-free path [4]. Our results are quite different from those obtained within a mean-field model, suggesting that the inclusion of short range correlations in the calculation is essential. In a subsequent work, we have used the Auxiliary Field Diffusion Monte Carlo method to test the accuracy of the correlated basis approach that has been used to calculate the density- and spin-density response of neutron matter at low energies [5]. We showed that the neutrino mean-free path is strongly affected by both short- and long-range correlations included in the nuclear wave function.

The contact parameter and the static structure factor of the unitary Fermi gas has been calculated using Quantum Monte Carlo methods. In [6] we have published a joint experimental-theoretical paper where we have carefully compared the results with a new experimental measurements. The agreement is very excellent, within 1% of accuracy.

We have carefully studied the effect of the effective range in the unitary Fermi gas, and showed that in the small limit the effective range and the energy are universally related and model independent [7]. Knowing this relation permit to make a quantitative comparison between low density neutron matter and cold atoms properties. The results are summarized in [8].

We have calculated the energy of the unitary Fermi gas in external potentials. A periodic (weak) external well at momenta lower than the Fermi momentum k_F is directly related to the phonon dispersion associated to the system. There is a tight connection between this dispersion and the lowest order term in a gradient-density expansion of the density functional. By including results in an external well at momentum about k_F , we have been able to constrain a simple density functional that well reproduces the Quantum Monte Carlo results. We have also verified the accuracy of the same functional to reproduce the properties of the gas in an harmonic trap [9].

4) The role of the nucleon-nucleon-hyperon force in hyper-nuclei has been investigated using the Auxiliary Field Diffusion Monte Carlo. In [10] we have adapted the code to include the Lambda hyperons, and we showed that the three-body force is dramatically important to qualitatively describe the saturation of the Lambda binding energy in hyper-nuclei. In a subsequent work we have proposed an improved three-body force that describe the experimental data much more accurately than previous Hamiltonians [11].

In the last few months we have extended the Auxiliary Field Diffusion Monte Carlo code to calculate the equation of state of neutron matter with few hyperons, and we expect to write a paper summarizing the results soon. Some preliminary study show that using the improved hyperon-nucleon forces, the resulting neutron star structure is in agreement with observations, that is not the case of using the original Hamiltonian.

5) We have developed a new Auxiliary Field Diffusion Monte Carlo code that permits to calculate the equation of state of symmetric and isospin-asymmetric nuclear matter. Some preliminary result shows a net improvement with respect old existing results. The new code has been extended to use more realistic nucleon-nucleon interactions than before. We have tested the accuracy of the new method by comparing the results with the more accurate Green's Function Monte Carlo, and we have also showed that the new code can be used to simulate much larger nuclei. The results will be submitted for publication soon.

6) We have extended the existing Quantum Monte Carlo codes to implement nuclear chiral forces obtained within the effective field theory framework. In Ref. [12] we have published a systematic study of the equation of state of neutron matter by discussing the role of the chiral expansion and the effect of the cutoff introduced to regularize the theory.

We have started to implement the same forces in the Green's Function Monte Carlo code, and discuss the structure of $A=3,4$ nuclei using chiral forces. The results will be submitted for publication soon.

Impact on National Missions

This research is of high relevance for the DOE Office of Science. The structure and dynamic properties of nuclei and nuclear matter have been identified as one of the most important scientific questions in nuclear physics in the most recent NSAC long-range plan. Part of this project was devoted to do research that is of high interest for the SciDAC UNEDF and NUCLEI collaborations, and to other LDRD-DR projects at LANL.

The results will have impact on several experiments aiming to measure the nuclear symmetry energy, to the future experiments on neutron rich matter like FRIB, and to neutrino oscillation experiments like LBNE.

References

1. Shen, G., L. E. Marcucci, J. Carlson, S. Gandolfi, and R. Schiavilla. Inclusive neutrino scattering off the deuteron from threshold to GeV energies. 2012. PHYSICAL REVIEW C. 86: 035503.
2. Lovato, A., S. Gandolfi, R. Butler, J. Carlson, E. Lusk, S. C. Pieper, and R. Schiavilla. Charge Form Factor and Sum Rules of Electromagnetic Response Functions in C-12. 2013. PHYSICAL REVIEW LETTERS. 111: 092501.
3. Lovato, A., S. Gandolfi, J. Carlson, Steven C. Pieper, and R. Schiavilla. Neutral weak current two-body contributions in inclusive scattering from ^{12}C . PHYSICAL REVIEW LETTERS.
4. Shen, G., S. Gandolfi, S. Reddy, and J. Carlson. Spin response and neutrino emissivity of dense neutron matter. 2013. PHYSICAL REVIEW C. 87: 025802.
5. Lovato, A., O. Benhar, S. Gandolfi, and C. Losa. Neutral current interactions of low-energy neutrinos in dense neutron matter. 2014. PHYSICAL REVIEW C. 89: 025804.
6. Hoinka, S., M. Lingham, K. Fenech, H. Hu, C. J. Vale, J. E. Drut, and S. Gandolfi. Precise Determination of the Structure Factor and Contact in a Unitary Fermi Gas. 2013. PHYSICAL REVIEW LETTERS. 110: 055305.
7. Forbes, M. M., S. Gandolfi, and A. Gezerlis. Effective-range dependence of resonantly interacting fermions. 2012. PHYSICAL REVIEW A. 86: 053603.
8. Carlson, J., S. Gandolfi, and A. Gezerlis. Quantum Monte Carlo approaches to nuclear and atomic physics. 2012. PROGRESS OF THEORETICAL AND EXPERIMENTAL PHYSICS. 1: A209.
9. Carlson, J., and S. Gandolfi. The Inhomogeneous Unitary Fermi Gas. PHYSICAL REVIEW LETTERS.
10. Lonardonì, D., S. Gandolfi, and F. Pederiva. Effects of the two-body and three-body hyperon-nucleon interactions in Lambda hypernuclei. 2013. PHYSICAL REVIEW C. 87: 041303.
11. Lovato, A., O. Benhar, S. Gandolfi, and C. Losa. Neutral current interactions of low-energy neutrinos in dense neutron matter. 2014. PHYSICAL REVIEW C. 89: 025804.

12. Gezerlis, A., I. Tews, E. Epelbaum, S. Gandolfi, K. Hebeler, A. Nogga, and A. Schwenk. Quantum Monte Carlo Calculations with Chiral Effective Field Theory Interactions. 2013. PHYSICAL REVIEW LETTERS. 111: 032501.

Publications

Bogner, S., A. Bulgac, J. A. Carlson, J. Engel, G. Fann, and others. Comput.Phys.Commun.. 2013. Comput.Phys. Commun.. 184: 2235.

Carlson, J., S. Gandolfi, and A. Gezerlis. Quantum Monte Carlo approaches to nuclear and atomic physics. 2012. PROGRESS OF THEORETICAL AND EXPERIMENTAL PHYSICS. 1: A209.

Carlson, J., and S. Gandolfi. The Inhomogeneous Unitary Fermi Gas. PHYSICAL REVIEW LETTERS.

Forbes, M. M., S. Gandolfi, and A. Gezerlis. Effective-range dependence of resonantly interacting fermions. 2012. PHYSICAL REVIEW A. 86: 053603.

Gandolfi, S., J. Carlson, S. Reddy, A. W. Steiner, and R. B. Wiringa. The equation of state of neutron matter, symmetry energy, and neutron star structure. 2014. THE EUROPEAN PHYSICAL JOURNAL A. 50: 10.

Gandolfi, S., J. Carlson, and S. Reddy. Maximum mass and radius of neutron stars, and the nuclear symmetry energy. 2012. PHYSICAL REVIEW C. 85: 032801.

Gezerlis, A., I. Tews, E. Epelbaum, S. Gandolfi, K. Hebeler, A. Nogga, and A. Schwenk. Quantum Monte Carlo Calculations with Chiral Effective Field Theory Interactions. 2013. PHYSICAL REVIEW LETTERS. 111: 032501.

Hagen, G., T. Papenbrock, A. Ekstrom, K. A. Wendt, G. Baardsen, S. Gandolfi, M. Hjorth-Jensen, and C. J. Horowitz. Coupled-cluster calculations of nucleonic matter. 2014. PHYSICAL REVIEW C. 89: 014319.

Hoinka, S., M. Lingham, K. Fenech, H. Hu, C. J. Vale, J. E. Drut, and S. Gandolfi. Precise Determination of the Structure Factor and Contact in a Unitary Fermi Gas. 2013. PHYSICAL REVIEW LETTERS. 110: 055305.

Illarionov, A. Y., S. Fantoni, F. Pederiva, S. Gandolfi, and K. E. Schmidt. Determination of the finite temperature equation of state of dense matter. 2012. PHYSICS OF ATOMIC NUCLEI. 75 (7): 866.

Lonardonì, D., F. Pederiva, and S. Gandolfi. Accurate determination of the interaction between Λ hyperons and nucleons from auxiliary field diffusion Monte Carlo calculations. 2014. PHYSICAL REVIEW C. 89: 014314.

Lonardonì, D., S. Gandolfi, and F. Pederiva. Effects of the two-body and three-body hyperon-nucleon interac-

tions in Lambda hypernuclei. 2013. PHYSICAL REVIEW C. 87: 041303.

Lovato, A., O. Benhar, S. Gandolfi, and C. Losa. Neutral current interactions of low-energy neutrinos in dense neutron matter. 2014. PHYSICAL REVIEW C. 89: 025804.

Lovato, A., S. Gandolfi, J. Carlson, Steven C. Pieper, and R. Schiavilla. Neutral weak current two-body contributions in inclusive scattering from ^{12}C . PHYSICAL REVIEW LETTERS.

Lovato, A., S. Gandolfi, R. Butler, J. Carlson, E. Lusk, S. C. Pieper, and R. Schiavilla. Charge Form Factor and Sum Rules of Electromagnetic Response Functions in ^{12}C . 2013. PHYSICAL REVIEW LETTERS. 111: 092501.

Maris, P., J. P. Vary, S. Gandolfi, J. Carlson, and S. C. Pieper. Properties of trapped neutrons interacting with realistic nuclear Hamiltonians. 2013. PHYSICAL REVIEW C. 87: 054318.

Shen, G., L. E. Marcucci, J. Carlson, S. Gandolfi, and R. Schiavilla. Inclusive neutrino scattering off the deuteron from threshold to GeV energies. 2012. PHYSICAL REVIEW C. 86: 035503.

Shen, G., S. Gandolfi, S. Reddy, and J. Carlson. Spin response and neutrino emissivity of dense neutron matter. 2013. PHYSICAL REVIEW C. 87: 025802.

Steiner, A. W., and S. Gandolfi. Connecting Neutron Star Observations to Three-Body Forces in Neutron Matter and to the Nuclear Symmetry Energy. 2012. PHYSICAL REVIEW LETTERS. 108: 081102.

Tsang, M. B., J. R. Stone, F. Camera, P. Danielewicz, S. Gandolfi, K. Hebeler, C. J. Horowitz, J. Lee, W. G. Lynch, Z. Kohley, R. Lemmon, P. Moller, T. Murakami, S. Riordan, X. Roca-Maza, F. Sammarruca, A. W. Steiner, I. Vidana, and S. J. Yennello. Constraints on the symmetry energy and neutron skins from experiments and theory. 2012. PHYSICAL REVIEW C. 86: 015803.

Precision Predictions for Jet Cross Sections

Christopher Lee
20120759ECR

Abstract

The production of hadronic jets in high-energy collisions is one of the most important and powerful probes of nucleon structure, the strong interaction, and of new physics beyond the Standard Model. In this project we made advances in methods to compute jet cross sections to high precision and accuracy and also applied them to new arenas. We applied the modern techniques of Soft Collinear Effective Theory (SCET) to predict to unprecedented accuracy jet cross sections in the deep inelastic scattering (DIS) of protons and electrons. We obtained results at next-to-next-to-leading (NNLL) logarithmic accuracy in resummed perturbation theory, with 10-20% theoretical uncertainties (down from 50% in previous calculations), and preliminary results for N³LL accuracy, with < 5% level theoretical uncertainty. This makes possible a future determination of the strong coupling as to percent-level precision, never before achieved from DIS data. This creates a new thrust for the physics program at a future Electron Ion Collider (EIC). In addition we discovered powerful new universality relations among nonperturbative corrections to several different event shape cross sections in DIS, further reducing theoretical uncertainty. These corrections also turn out to be related to so-called underlying event corrections in proton-proton collisions at the Large Hadron Collider (LHC), extending further the reach and impact of our discovery. We also compared SCET methods with traditional methods in perturbative Quantum Chromodynamics (QCD) and derived new equivalence relations that help improve the reliability of both methods. Finally we made progress on constructing new effective field theories that can be used to factorize and resum logarithms in QCD perturbation theory that have never before been analytically resummed beyond the leading-logarithmic (LL) level; namely, non-global logarithms (NGLs) in jet cross sections defined with non-global measures of soft radiation such as vetoes on extra jets, and logarithms of jet radii R in exclusive jet cross sections. Resumming both types of logarithms is essential to reduce theoretical uncertainty

in the backgrounds to searches for new physics at the LHC. In summary, our progress during this LDRD project has opened several new avenues for future research, namely, precision extraction of the strong coupling at a future EIC and new approaches to significantly reduce theoretical uncertainties in jet cross sections at the LHC and other colliders.

Background and Research Objectives

With the advent of the Large Hadron Collider (LHC) we are now searching in the most energetic proton-proton collisions to date for new particles and forces that may explain the origin of mass, matter and dark matter, and the physics of the first instants of the Universe. While signatures of new physics could be dramatic, they will more likely show up as subtle deviations in the data from predictions based purely on the Standard Model of particle physics. Measuring these deviations reliably, however, requires that the background Standard Model predictions be performed very precisely and accurately. Many candidate new particles are expected to decay to “jets” of strongly-interacting hadrons, made of quarks and gluons. The number of jets produced by ordinary Standard Model processes, however, is enormous. Reliably telling apart new physics jets from Standard Model jets requires extremely precise theoretical calculation of Standard Model jet cross sections. Also many newer search strategies for new particles at the LHC involve probing the detailed substructure of individual jets. The dependence of jet cross sections on these details has never been calculated precisely.

At the same time, strong interaction physics can be studied in other types of collisions, namely, electron-positron (e^+e^-) collisions producing hadronic jets (such as at the former Large Electron-Positron (LEP) collider at CERN), and the deep inelastic scattering of electrons (e) and protons (p), such as at the HERA experiment at DESY in Germany or the future Electron-Ion Collider hoped for in the US. These experiments reveal basic information like

the size of the strong coupling as that governs the strength of the strong interaction itself, and the structure inside the proton, namely, the momentum distribution of the constituent partons (quarks and gluons). While this information relates directly only to Standard Model particles, it is fundamental input into predictions for cross sections at colliders like the LHC that search for new physics. Without precise knowledge of standard strong interaction physics, searches for new physics at the LHC are doomed to failure.

Thus improving the precision of predictions for jet cross sections at all types of colliders, $e+e-$, ep , and pp , are intimately linked.

Accurately predicting jet cross sections requires summing the probabilities of emitting arbitrarily many gluons or quarks (partons) within and out of jets. The probability of emitting a fixed number of soft or collinear partons diverges logarithmically as a function of the partons' energies. To obtain a physically accurate, finite probability, we must "resum" the probabilities of emissions of arbitrarily (infinitely!) many partons. The jet-like nature of the final state can be measured in two ways. First, the whole event can be measured with a variable called an "event shape", probing with a single "global" measure the degree to which the final state particles are organized into jet-like structures. Logs of the event shape variable in cross sections can be summed using an effective theory like SCET with only one collinear and one soft scale. A second way is to define individual jets exclusively, with a definite size (radius) R and a definite number of jets in the final state. In this case, when correlated radiation is emitted simultaneously in and out of a jet, the probability depends on logarithms (logs) of ratios of energy scales in the two separate regions---for example, the large energy within a jet versus the soft veto energy outside. These logs are "non-global logs" which have never successfully been resummed in QCD. The probabilities also depend on logarithms of the jet sizes R . These logs have not been resummed beyond leading-order accuracy either. The precise predictions we need at the LHC to distinguish Standard Model from new-physics jets require that we do better. It was a goal of this project to fill this gap in our predictive power.

In the past decade, there has been a revolution in theoretical methods for computing jet cross sections. Soft Collinear Effective Theory (SCET) has emerged as a powerful tool for achieving levels of precision beyond (in some cases, by orders of magnitude) traditional methods in perturbative QCD. SCET does so by replacing QCD with a theory of only collinear (highly-energetic and boosted) and soft (low energy) quarks and gluons. These are the relevant degrees of freedom in a jet cross section. The PI Lee played a central role in some of the key historic developments, making the

first applications of SCET to $e+e-$ event shape distributions [1,2,3,4], discovering powerful new universality relations for nonperturbative corrections to event shapes [5], pioneering the treatment of jet algorithms in SCET [6,7] as well as the first casting of the issue of non-global logarithms in the language of SCET [8,9].

Despite these advances in predicting global jet cross sections, SCET lacks the multiple soft degrees of freedom that are needed to describe an exclusive jet cross section defined with vetoes on energy outside the jets, which induces sensitivity to multiple scales and gives rise to "non-global" logs. The collinear sector of SCET has also not yet been specialized to deal with summation of logs of jet radii.

In this project we pursued two main directions of research. The first area is in the novel application and deeper study of the methods of standard SCET in jet cross sections defined by global event shapes, which induce sensitivity only to a single scale of soft radiation, and thus allow the use of ordinary SCET. In this area we applied SCET to jet cross sections in DIS for the first time and significantly advanced the level of precision (by a order of magnitude) over previous work using traditional QCD. We also undertook a major study to compare the methods of SCET and traditional QCD as they have been applied to event shape distributions in electron-positron collisions. In the process we uncovered powerful new equivalence relations, making the comparison of results from the respective literature a much easier task. We also discovered ways in which the results of the two formalisms can be made more accurate or reliable. Both this work on $e+e-$ collisions and the work on DIS have significant implications for pp collisions at the LHC as well. These accomplishments will be described in more detail in the next section.

The second main area of research was the construction of new effective theories or extensions of SCET that can be used to resum non-global logarithms and logarithms of jet sizes in jet cross sections. Predicting the precise dependence of jet cross sections on properties such as jet sizes and additional jet energy vetoes requires solving two outstanding problems in QCD, mentioned above. First is the resummation of "non-global logarithms" in QCD perturbation theory. This means summing the probabilities of emitting arbitrarily many soft gluons and quarks into different regions of an event measured with different scales, as occurs in most LHC jet cross sections. Second is the resummation of logs of jet radii R . As smaller and smaller jets and "subjets" (jets within jets) are being used to probe new phenomena at the LHC, the resummation of these logs becomes vital to make accurate and precise predictions of jet cross sections. In this project we developed some

tools that promise to solve these theoretical problems, which would allow prediction of many classes of jet cross sections at the LHC to unprecedented precision, making a major advance in our ability to search for physics beyond the Standard Model. These advances will be described below; work to further develop and apply these methods to LHC physics continues, now funded by our DOE Nuclear Physics grant.

These accomplishments have opened new avenues of research to be pursued beyond the end of this LDRD ECR. First, our work has made the measurement of jet cross sections in DIS a promising way to extract the size of the strong coupling at a precision that is competitive with those from e+e- collision data, which so far provide the most precise extractions. This provides strong motivation for a future EIC to pursue this goal. Successful extraction of α_s from EIC data will help resolve existing discrepancies between values extracted from different methods. Second, we have provided more reliable ways to express resummed differential cross sections in SCET and QCD perturbation theory, which should be applied to all jet cross section predictions for the LHC and other colliders. Finally, we have constructed the first simple candidate effective field theories that can sum logarithms of non-global measures or of jet radii. This has generated a direction of new research being pursued with new postdocs in T-2, and their successful completion will revolutionize the precision prediction of exclusive jet cross sections used at the LHC to search for new physics and also in heavy-ion collisions at LHC and at the Relativistic Heavy-Ion Collider (RHIC).

Scientific Approach and Accomplishments

Soft Collinear Effective Theory is a version of Quantum Chromodynamics that contains only soft (low-energy) and collinear (highly-energetic and boosted) degrees of freedom (quarks and gluons) and predicts to high accuracy strong interaction cross sections that are dominated by these degrees of freedom, such as in the production of hadronic jets or simply in collisions containing one or more energetic protons. SCET naturally factorizes such cross sections into separately calculable hard, collinear, and soft functions, each of which contain logarithms of a single energy scale divided by an arbitrary factorization scale μ . SCET comes with a set of renormalization group evolution equations that predict the full μ dependence of these functions. Solving these equations automatically resums the large logarithms to all orders in α_s . The accuracy to which these logs are resummed depends on the order to which the anomalous dimensions of each function are computed, basically, the quantum corrections that are most sensitive to the soft and collinear divergences generated by emission of particles with those momenta.

DIS Event Shapes to Next-to-Next-to-Leading-Log Accuracy and Beyond

While resummation of non-global logs or logs of jet radii require extensions of SCET beyond the simple framework of one collinear and one soft scale, global measures such as event shapes can be resummed fully within ordinary SCET. One of the first things we noticed during this project was that there was a whole arena in which global event shapes had not yet been resummed beyond next-to-leading-log accuracy, namely, in deep inelastic scattering of electrons and protons. Applying SCET promised to vastly improve the precision with which we could predict jet cross sections in DIS. We used an event shape called 1-jettiness to define the cross section. In general N-jettiness [10] measures how well collimated the final state hadrons are into N separated directions, in addition to any collinear radiation along the initial beam direction(s). In DIS, 1-jettiness near zero means there is exactly one collimated jet in the final state plus collimated radiation along the initial proton direction. Large 1-jettiness (near 1) means there are energetic particles in additional directions, e.g. a second jet away from the beam direction. Such measures are highly sensitive to the size of the strong coupling, which governs how much the jets radiate. Thus they are excellent candidates for extraction. But in DIS, event shape distributions had not been computed to sufficiently high precision to make this worthwhile.

We derived the first factorization theorem for an event shape in DIS using the methods of SCET. Using this theorem and existing results for the one-loop hard, jet, beam, and soft functions in SCET, we were able to compute three different versions of the 1-jettiness distribution in DIS to next-to-next-to-leading-logarithmic accuracy, one order beyond what had previously been done using traditional QCD. However, the previous result did not include reliable estimates of the theoretical uncertainty. We provided this both for the old and our new result. The improvement in the precision of our result is illustrated in Figure 1, showing the differential cross section for one version of the 1-jettiness.

Another major result of this work was the discovery of universality relations among the leading nonperturbative corrections to the three versions of 1-jettiness we considered. In addition to the logs and other terms predicted by resummed perturbation theory, there are additional contributions to the 1-jettiness distributions due to the subsequent process of hadronization of quarks and gluons as they get confined into mesons and baryons at a relatively late time scale. These contributions cannot be calculated from first principles. But the relation among them for different observables can sometimes be predicted. We

derived that for these three observables these corrections are actually identical. This provides a powerful improvement in predictive power and reduction of theoretical uncertainty. This universality is illustrated in Figure 2.

Recently, motivated by our discovery of this universality, another group was able to show that these nonperturbative corrections in DIS event shapes are also related to an important class of nonperturbative corrections called the underlying event in pp collisions at the LHC [11]. These are corrections due to radiation from the spectator partons in the protons that do not actively participate in the hard collision of the “active” quarks or gluons and which had not previously been treated rigorously in quantum field theory. Thus our discovery in the context of DIS has even wider ranging implications and impact than initially appreciated and will play a role in searches for new physics at LHC.

The NNLL perturbative results and the prediction of non-perturbative universality described above were published in Phys. Rev. D88 (2013) 054004 and presented at the DIS 2013 workshop, proceedings PoS DIS2013 (2013) 158.

Since then we have nearly completed two additional publications that improve further the precision of our results. First, we have computed the next-to-leading-order (NLO) fixed-order corrections to the 1-jettiness distribution resulting from emission of one additional gluon from a quark in the initial proton or from one in the final state, or from the splitting of a gluon in the initial proton into a quark-antiquark pair. While the divergent logs from these processes are already included in the NNLL resummed results, the non-logarithmic finite terms are not. Computing the latter corrections adds to the accuracy of the final results. Second, we have made use of newly available results for the two-loop corrections to the beam function [12] and for the two-loop soft function to improve the accuracy of our resummed predictions to unprecedented N3LL accuracy. The uncertainty of these results is at the 5% level. This is at the level where they can be used for percent level extraction of the strong coupling α_s . This is an important new goal for our group’s research in the next few years.

The aforementioned results for the two-loop soft function were obtained by O. Zhang who was a visiting student to our group last summer, supervised by the PI Lee. She will visit T-2 again this Spring and Summer to complete the publication of that work. The results of our NLO and N3LL calculations will be presented by our collaborator D. Kang at the SCET 2014 Workshop in Munich, Germany at the end of March 2014, and should be published shortly thereafter.

Comparing and counting logs in traditional QCD and modern SCET methods of resummation

In the course of making new applications and solving new problems using the modern techniques of SCET, it is important to compare and contrast the methods and results with those from the traditional QCD literature. Although both descriptions are in principle equivalent, their actual implementation in the literature often looks formally different and sometimes numerical results purportedly computed to the same accuracy also disagree. To increase the visibility and impact of our work in SCET, it is vital to relate it to the work in the traditional QCD community as well. Thus as part of this ECR, we undertook an extensive comparison of the two methods in the context of event shape distributions in e+e- collisions, although the conclusions and lessons are equally valid for ep and pp collisions.

In this work we took apparently different formulas for resummed event shape distributions in QCD and SCET and derived new, illuminating equivalence relations for every quantity appearing in the two versions. This alone makes comparing results in the two sets of literature a much easier task than before. On top of this, as a result of the comparison, we were able to show how to improve formulas in both formalisms. In the one case, we were able to improve the estimation of uncertainties in cross section computed using traditional QCD methods by importing more reliable methods developed in SCET. In the other direction, we were able to improve the raw accuracy of the SCET formulas themselves. Although when evaluated to infinite accuracy the two formulas are equal, in practice they are truncated at a finite accuracy, and the terms, which are truncated, can differ. We defined new truncation schemes, which maintain equivalent accuracy between the two formalisms.

Some practical results of these improvements can be seen in Figure 3. The first set of plots show the differential thrust distribution in e+e- collisions computed at two orders of accuracy. They show that our new, improved formulas show better convergence from one order to another, that is, the higher-order value lies within the uncertainty bands of the lower-order, as one expects from results whose uncertainties are computed reliably. Our new formula and truncation scheme can therefore be trusted to give more reliable estimates of the true theoretical uncertainty. The other set of plots show the total integral of the differential distribution, and shows that our new formulas integrate more accurately to the known total cross section. Implementation of our methods in other contexts (ep, pp collisions) can be expected to produce similar improvements.

The results of this work have been published in the Journal

of High-Energy Physics [JHEP04 (2014), 174], and have already caught the attention of the wider physics community. The PI presented the work in invited talks at the Boston Jet Physics Workshop in January 2014 and the Soft-Collinear Effective Theory Workshop in Munich in March 2015, and has been invited to give a plenary talk at the LoopFest XIII Workshop in Brooklyn, NY, in June 2015.

New effective theories for non-global logs and logs of jet radii

During this project we explored several candidates for effective field theories to resum non-global logarithms (NGLs) and logs of jet radii R . Among these we identified two promising candidate theoretical frameworks on which we are continuing to work in order to fully implement them to achieve the logarithmic resummations.

The first framework applies to summing NGLs. We separate the modes of full QCD into hard and soft degrees of freedom. This results in an effective theory resembling the long-neglected Large Energy Effective Theory (LEET) introduced in 1991 [13] but abandoned in favor of SCET in 2000 because of its inapplicability to problems requiring collinear gluon modes. We have uncovered the applicability of LEET to non-global logs, which only require the factorization of soft from hard modes and thus no additional collinear modes. We are excited by the rediscovery of LEET in this context and its promise to solve the long-standing problem of summing NGLs. The hierarchy of scales is illustrated in Figure 4.

The other framework is the separate factorization of these hard and soft sectors into hard/hard-collinear and soft/soft-collinear modes. The soft/soft-collinear factorization is also a step we have proposed for the first time. The relevant hierarchy of scales is illustrated in Figure 5. We are in the midst of completing the theoretical formulation of this doubly-factorized effective field theory and implementing it to resum logs of R and NGLs. In fact the two sets of logs can be summed separately, with the results combined later. We are currently following this parallel procedure.

The formulation of the effective theory frameworks for both problems has been completed, but some concrete calculations required to validate them are still under way. Namely we need to compute double-gluon emission contributions both in full QCD and in our effective theories and show how they match. These computations are in progress in collaboration with our new postdocs Y.-T. Chien and A. Hornig and should be completed within the fiscal year.

We emphasize that these are long-standing, unsolved problems in QCD. While we had hoped to complete pub-

lications on them within the timeframe of this LDRD ECR, we are very pleased by the promise of the new effective theories we have constructed to solve them. The computations required to validate them will take additional time, mainly with DOE Nuclear Theory funding, but the establishment of a concrete path to their solution should be considered a major accomplishment of this ECR funded work.

Impact on National Missions

Two key missions of the DOE Office of Science in Nuclear and High-Energy Physics are 1) to improve our understanding of Quantum Chromodynamics (QCD), the theory of the strong interactions between quarks and gluons, constituents of all ordinary matter; and 2) to search for new particles and forces beyond the Standard Model that will explain the origin of matter, dark matter, and masses of elementary particles. Our research under this project has made advances in both directions.

We have pushed forward the frontier of precision achievable in predictions of jet cross sections in electron-proton collisions to be studied at a future Electron-Ion Collider, a top priority for US Nuclear Physics and the Physics program at LANL. Our research has opened up a new thrust for the EIC physics program, to measure the strong coupling to percent-level precision and resolve discrepancies in competing data. The 2007 NSAC Long-Range Plan for DOE emphasizes, “The EIC embodies the vision of our field for reaching the next QCD frontier,” and “it is essential that theoretical support for EIC-related physics is maintained at a healthy level.”

Furthermore, we have made advances in theoretical methods for computing jet cross sections that are applied to studies at the LHC in searches for new physics and at LHC and RHIC in studies of the quark-gluon plasma in heavy-ion collisions, as well as studies of proton structure at Fermilab, all top research priorities in the US DOE Office of Science Nuclear and High-Energy Physics programs and in which LANL plays leading roles. The achievements during this project have opened new, exciting research avenues in strong interaction physics of interest to the DOE Nuclear Theory program.

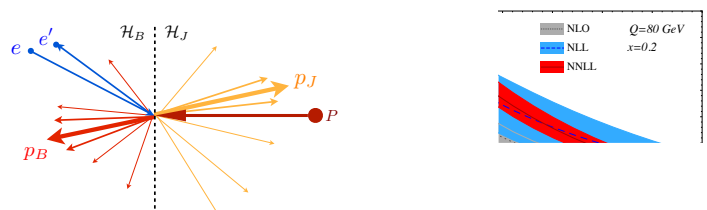

Figure 1. Deep inelastic scattering of electron against proton,

producing one jet from final-state radiation (orange) and one jet from beam radiation (red) collinear to the initial proton direction. Right: 1-jettiness event shape distribution computed in resummed perturbation theory. Previous results were computed to NLL accuracy (blue). We achieved results to NNLL accuracy (red) and have preliminary results to NNNLL accuracy (not shown). The NLO fixed-order result (grey) shows the divergence at small values of 1-jettiness that is tamed only by the resummation.

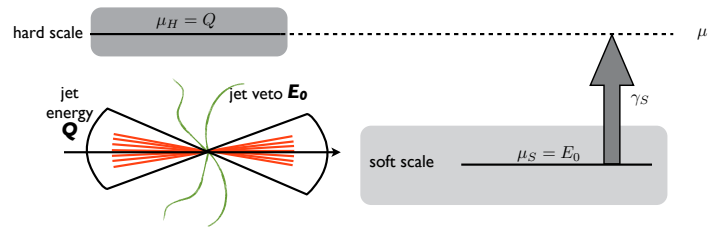

Figure 4. Effective field theory for non-global logs of jet veto energy E_0 divided by jet energy Q . The jet cross section is defined by requiring most of the energetic particles to be contained within two cones of radius R with no more than an amount E_0 of energy radiated out of the cones. The cross section then depends on logs of E_0/Q which are “non-global” since the scale E_0 is probed only outside the cones.

$$\xrightarrow{2\Omega_1/Q} \quad \Omega_1^a = \Omega_1^b = \Omega_1^c$$

Figure 2. Nonperturbative shift due to hadronization (confinement) of quarks and gluons in the final-state jets produced in deep inelastic scattering. The red is the distribution in 1-jettiness computed purely in resummed perturbation theory. Hadronization shifts the distribution to the right (i.e. broadens the jets) by an amount that is not calculable from first principles but can be related amongst different versions of 1-jettiness. For three different versions we proved that this nonperturbative shift would be equal.

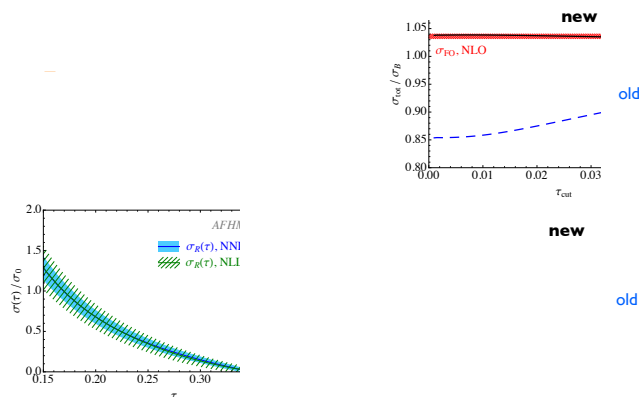

Figure 3. Left: Differential thrust distribution in electron-positron collisions computed at NLL and NNLL accuracy in resummed QCD perturbation theory, according to previous formulas in SCET (top) and our new formulas (bottom) with improved accuracy. The new formulas exhibit better convergence from one order to the next, indicating better accuracy and estimation of theoretical uncertainty. Right: Total integrated cross section computed from old and new formulas, as function of an arbitrary parameter τ_{cut} used to stabilize the integral over the small thrust region. The new formulas exhibit better agreement with the known total cross section and stability with respect to the τ_{cut} parameter.

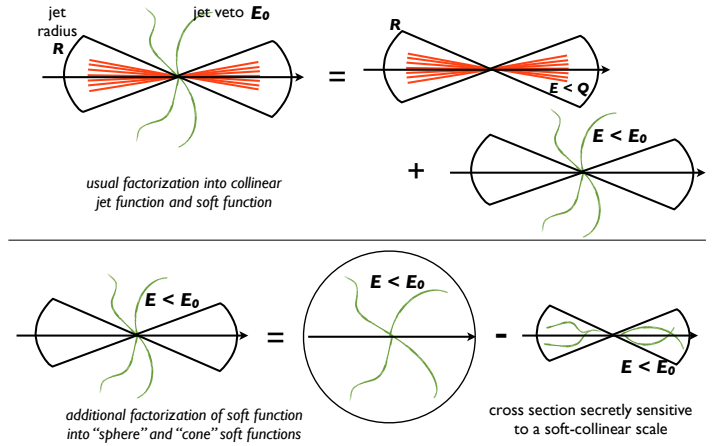

Figure 5. Effective field theory framework for resummation of logs of jet radii R . Ordinary SCET contains only one collinear and one soft mode. We have discovered that logs of R in jet cross sections come from sensitivity to two separate hard-collinear and soft-collinear scales. The hard-collinear scale is caused by the confinement of energetic particles of energy Q inside a cone of radius R . The soft-collinear scale is caused by forcing particles of the softer energy E_0 to lie entirely outside these cones.

References

1. Bauer, C. W., C. Lee, A. V. Manohar, and M. B. Wise. Enhanced nonperturbative effects in Z decays to hadrons. 2004. PHYSICAL REVIEW D. 70 (3): -.
2. Bauer, C. W., S. Fleming, C. Lee, and G. Sterman. Factorization of $e(+)\bar{e}(-)$ event shape distributions with hadronic final states in soft collinear effective theory. 2008. PHYSICAL REVIEW D. 78 (3): -.
3. Hornig, A., C. Lee, and G. Ovanessian. Infrared safety in factorized hard scattering cross-sections. 2009. PHYSICS LETTERS B. 677 (5): 272.
4. Hornig, A., C. Lee, and G. Ovanessian. Effective pre-

dictions of event shapes: factorized, resummed and gapped angularity distributions. 2009. JOURNAL OF HIGH ENERGY PHYSICS. (5): -.

2013). Vol. DIS 2013, p. 158. Trieste, Italy: Proceedings of Science.

5. Lee, C., and G. Sterman. Momentum flow correlations from event shapes: Factorized soft gluons and soft-collinear effective theory. 2007. PHYSICAL REVIEW D. 75 (1): -.
6. Ellis, S. D., A. Hornig, C. Lee, C. K. Vermilion, and J. R. Walsh. Consistent factorization of jet observables in exclusive multijet cross sections. 2010. PHYSICS LETTERS B. 689 (2-3): 82.
7. Ellis, S. D., C. K. Vermilion, J. R. Walsh, A. Hornig, and C. Lee. Jet shapes and jet algorithms in SCET. 2010. JOURNAL OF HIGH ENERGY PHYSICS. (11): -.
8. Hornig, A., C. Lee, I. W. Stewart, J. R. Walsh, and S. Zuberi. Non-global structure of the $O(\alpha^2(s))$ dijet soft function. 2011. JOURNAL OF HIGH ENERGY PHYSICS. (8): -.
9. Hornig, A., C. Lee, J. R. Walsh, and S. Zuberi. Double non-global logarithms in-n-out of jets. 2012. JOURNAL OF HIGH ENERGY PHYSICS. (1): -.
10. Stewart, I. W., F. J. Tackmann, and W. J. Waalewijn. N Jettiness: An Inclusive Event Shape to Veto Jets. 2010. PHYSICAL REVIEW LETTERS. 105 (9): -.
11. Stewart, I., F. Tackmann, and W. Waalewijn. A field theory look at the underlying event. Invited presentation at Boston Jet Physics Workshop 2014. (Cambridge, MA, 21-23 Jan. 2014).
12. Gaunt, J. R., M. Stahlhofen, and F. J. Tackmann. The quark beam function at two loops. arXiv:1401.5478.
13. DUGAN, M. J., and B. GRINSTEIN. QCD BASIS FOR FACTORIZATION IN DECAYS OF HEAVY MESONS. 1991. PHYSICS LETTERS B. 255 (4): 583.

Publications

- Almeida, L., S. D. Ellis, C. Lee, G. Sterman, I. Sung, and J. Walsh. Comparing and counting logs in direct and effective methods of resummation. 2014. Journal of High-Energy Physics. 04: 174.
- Kang, D., C. Lee, and I. W. Stewart. Using 1-jettiness to measure 2 jets in DIS 3 ways. 2013. PHYSICAL REVIEW D. 88 (5): -.
- Kang, D., C. Lee, and I. W. Stewart. 1-jettiness in DIS: measuring 2 jets in 3 ways. 2013. In Twenty-First International Workshop on Deep-Inelastic Scattering and Related Subjects (DIS2013). (Marseille, France, 22-26 Apr.

Ultra-Bright Electron Beam Acceleration in Dielectric Wake Accelerators

Evgenya I. Simakov

20130463ER

Introduction

The goal of this project is to demonstrate operation of a high-brightness Dielectric Wakefield Accelerator (DWA) with an acceleration gradient above 100 MV/m and less than 0.1% induced energy spread in the accelerated beam. We currently project the DWA concept as a performance upgrade for the future LANL signature facility MaRIE. The pre-conceptual design for MaRIE is underway at LANL, with the design of the electron linear accelerator being one of the main re-search goals. The cost of the linac is significant and the TA-53 space constraints dictate that the final energy of the electron beam for the X-ray Free-Electron Laser (XFEL) is no higher than 12 GeV. The number and the energy of photons produced by the XFEL is however strongly dependent on the electron beam's energy with the more energetic beam delivering more energetic photons to the user. Although generally the baseline design needs to be conservative and rely on existing technology, any future upgrade would immediately call for looking into the advanced accelerator concepts capable of boosting the electron beam energy up by a few GeV in a very short distance without degrading the beam's quality. This work has the potential to advance the DWA technology to a level that would make it suitable for MaRIE and also for a number of other national security applications.

Benefit to National Security Missions

The proposed work has the potential to advance dielectric wakefield accelerator technology to a level to make it suitable for a number of national security applications, including compact accelerators for warfighter support (e.g. small weaponized free-electron lasers) and active interrogation (e.g. small and in-expensive electron accelerators as compact front ends for muon active interrogation sources or alternatively to generate bremsstrahlung radiation). Additionally, this technology may be applicable for the future upgrades to increase the energy and luminosity of the MaRIE XFEL.

Considering the long time scale associated with the MaRIE project, this technology, if demonstrated now, may provide an approach to boost the energy of the electron beam feeding the MaRIE XFEL from the nominal 12 GeV up to 20.8 GeV with a very low cost upgrade. This upgrade would allow a much greater production of 126-keV photons, now at the third harmonic of 42 keV. With the current 12 GeV MaRIE linac design, generation of the third harmonic photons is suppressed in the wiggler. However, photon energy above 120 keV is required for the K-shell ionization of uranium and other actinides, an important MaRIE mission and part of its funding justification. An 8.8-GeV DWA afterburner would lead to over an order of magnitude greater production of these high energy photons.

Progress

The progress in Year 2 of the project was three-fold. First, we worked on putting together the complete concept of a high energy dielectric wakefield accelerator afterburner. We analyzed possible effects that would preclude the effective transfer of energy from the drive electron bunch to the main bunch over a long distance. Simulations were conducted in Elegant. Two major effects were the beam break up due to dipole wakefields and the de-phasing. We proposed certain modifications to the beam line to mitigate undesired effects. We conducted simulations of over the long propagation distances and demonstrated that a periodic array of focusing and defocusing quadrupoles with tapered strength effectively suppresses beam breakup. The de-phasing effect is due to the drive bunch slowing down when its energy is transferred to the main bunch. Tapering the dimension of the dielectric tubes in the accelerating structure allows us to compensate for the de-phasing. Overall, we put together a beamline schematics that would allow us to transfer over 90 per cent of energy from the drive bunch to the witness bunch. Second, we conducted full particle-in-cell (PIC) simulations of propagation of high

charge electron bunches in dielectric tubes with two different PIC codes - LSP and Merlin. The aim of the PIC simulations was to evaluate the full effect of the beam break up in 3D geometry, something that cannot be performed using the simple matrix code Elegant.

Also full 3D PIC simulations allowed us to get some understanding of important transverse and longitudinal space charge effects that will play a role in real-life experiments when the bunch charge is high, but cannot be estimated with any other code. Third, we conducted a series of experiments at the Accelerator Test Facility in Brookhaven National Laboratory to optimize the design of the beam shaping mask for production of the shaped electron bunches and performed some preliminary experiments on the enhanced transformer ratio. The design of the shaping mask had to account for the realistic parameters of the beam line and beam jitter. The dimensions of the dielectric tube had to be experimentally adjusted once the effect of the beam jitter was identified. We believe that these experiments provided our team with the experience necessary to conduct the beam shaping experiment on a real test stand with an Emittance Exchanger (EEX) at Argonne National Laboratory (ANL). LANL participated in monthly teleconference meetings with a team at Argonne National Laboratory to get the updates on the status of the ANL's EEX facility. The EEX is planned to start operating by the end of summer 2014 and LANL will be the first user group to conduct the beam shaping experiments.

LANL also organized the 2nd Workshop on Applications of Dielectric Wakefield Accelerators for future Free Electron Laser facilities. The workshop was held in Los Alamos in December 2013. Participants presented their recent progress in the area of dielectric wakefield accelerators and discussed the applicability of the concept for the proposed MaRIE LANL signature accelerator facility. LANL team presented 3 talks at the US Particle Accelerator Conference in October, 2013, three talks at 2nd Workshop on DWAs for the FELs, submitted two abstracts for the Advanced Accelerator Concepts workshop in July, 2014, co-authored an invited talk for the FEL2014 conference in August, 2014, and published one paper in a refereed journal.

Future Work

In FY15 the project will focus on experimental verification of the developed concepts. All theoretical simulations are now complete. Preliminary experiments were performed at a test stand at Brookhaven National Laboratory to demonstrate shaping of an electron beam with a mask but with no Emittance Exchanger (EEX). The high transformer ratio demonstration experiments were started at Brookhaven and will be completed before the end of FY14.

In FY15 our team will focus on the demonstration of the bunch shaping with the EEX. All experiments will now be conducted at Argonne Wakefield Accelerator facility at Argonne National Laboratory, which has an available EEX test stand. We plan to demonstrate the production of the shaped electron bunches and simultaneous production of the drive and witness bunches. We will then pass the shaped bunches through a dielectric tubes and demonstrate the enhanced transformer ratio.

Conclusion

The most important outcome of the proposed research will be the experimental demonstration of a high-brightness dielectric wakefield accelerator with an accelerating gradient well above 100 MV/m and less than 0.1% induced energy spread in the accelerated beam. It is very likely that we will be able to demonstrate the following secondary outcomes: (1) simultaneous generation of a drive bunch and main beam for the first time, (2) significant increases in a DWA transformer ratio, and (3) significant decreases in the measured energy spread from a main beam accelerated through a wakefield process.

Publications

- Gai, W., C. Jing, A. Kanareikin, C. Li, R. Lindberg, J. Power, D. Shchegolkov, E. Simakov, Y. Sun, C. X. Tang, and A. Zholents. Assessment of Opportunity for a Colinear Dielectric Wakefield Accelerator for a Soft X-Ray FEL Facility. To appear in 36th International Free Electron Laser Conference FEL 2014. (Basel, Switzerland, 25-29 August, 2014).
- Huang, C., T. Kwan, D. Shchegolkov, and E. Simakov. Particle-In-Cell Modeling of Dielectric Wakefield Accelerator. 2013. In 2013 North American Particle Accelerator Conference. (Pasadena, CA, Sept. 29 - Oct. 4th, 2013). , p. MOPAC23. online: JACoW.
- Shchegolkov, D. Y., and E. I. Simakov. Design of an emittance exchanger for production of special shapes of the electron beam current. 2014. PHYSICAL REVIEW SPECIAL TOPICS-ACCELERATORS AND BEAMS. 17 (4).
- Shchegolkov, D. Yu., E. I. Simakov, C. Jing, C. Li, and A. A. Zholents. Suppressing Parasitic Effects in a Long Dielectric Wakefield Accelerator. To appear in Advanced Accelerator Conference Workshop. (San Jose, CA, 13-18 July, 2014).
- Shchegolkov, D., E. Simakov, S. Antipov, M. Fedurin, and C. Swinson. Beam Pulse Shaping Experiments for Uniform High Gradient Dielectric Wakefield Acceleration. 2013. In 2013th North American Particle Accelerator Conference. (Pasadena, CA, Sept.29-Oct.4th, 2013). , p. MOPAC24. online: JACoW.

Simakov, E., C. Huang, T. Kwan, and D. Shchegolkov. Shaping Electron Bunches for Ultra-bright Electron Beam Acceleration in Dielectric Loaded Waveguides. 2013. In 2013 North American Particle Accelerator Conference. (Pasadena, CA, Sept. 29 – Oct. 4th, 2013). , p. TUMPA13. online: JACoW.

Coherent Diffractive Imaging of Ultrafast Ejecta Processes

Cynthia A. Bolme
20130632ER

Introduction

This project will use an ultrafast laser to create a shock wave at a metal sample surface. The metal sample will have a periodically roughened surface, and the interaction of the shock wave with the structured surface will create instabilities in the material that will evolve in small jets of ejecta particles. This process will be imaged using ultrafast soft x-rays that are created by the same laser system that drives the shock. Using coherent soft x-rays, we will provide resolution of the ejecta formation process that is 20 times better than has been previously performed.

We will also perform molecular dynamic simulations of this ejecta forming process that are perfectly matched in length and time scales to the experiments. By comparing the simulation with the experiments, we will gain new insight into instability formation and evolution. By comparison of these results with previous results of larger scale ejecta formation, we will learn about the importance of time and length scales on instability growth.

Benefit to National Security Missions

The development of this tabletop source will immediately address core mission problems and provide important validation of physics-based material models as the spatial and temporal resolutions achievable with this imaging diagnostic will be orders of magnitude better than current dynamic diagnostic alternatives. This diagnostic ability was specifically called out in the report from the Research Needs for Material Mixing at Extremes workshop stating, "developing diagnostics for HED flows that will allow us to penetrate the mixing regions with greater resolution than ever before achieved." This project will also greatly advance the state-of-the-art in dynamic materials imaging using coherent x-ray diffractive imaging, a key diagnostic proposed in the Matter-Radiation Interactions in Extremes (MaRIE) signature facility.

Progress

Our efforts have been focused on the high energy, second stage laser amplifier system that have given our project some major challenges. These challenges include a broken laser pump system and problems with the existing optics that have led to optical damage. We have been working on overcoming these issues by redesigning some of the optics for the second stage amplifier and purchasing new components. These changes seem to have greatly increased the available laser energy we can extract without damaging the laser. Furthermore, a broken pump laser for the second stage amplifier hindered our efforts for several weeks until we could get it replaced by an offsite service technician. Currently, we have successfully compressed the amplified 10 Hz laser for the high harmonic generation drive and imaging to 38 fs, shorter than the 50 fs we were hoping for. We currently have up to about 50 mJ of pulse energy in this short pulse and have plans to upgrade the power to around 100 mJ of compressed laser energy.

Additional progress has been made on securing the needed parts for the vacuum chambers and high harmonic generation chamber. We now have all of the soft x-ray components and equipment acquired and installed necessary to generate our soft x-ray imaging probe beam and to characterize it. Currently, efforts are underway to generate the first soft x-ray beam for imaging. Once this has been accomplished, we will immediately move to generating simple diffraction patterns from test samples and to reconstructing those images using coherent diffractive imaging algorithms. Within the next few months we plan on conducting the first static imaging experiments.

The development of this unique system has been attracting interest from outside collaborators including Prof. Brian Abbey's group from La Trobe University in Melbourne, Australia who was a Physics Colloquium speaker last fall. Furthermore, a recent LANSCE hire, Prof. Edwin

Fohtung, who is also a professor at New Mexico State University has expressed interest in collaborating with us and using this unique single shot imaging system. These two groups bring strong expertise in coherent diffractive imaging techniques and algorithms and will greatly speed up the progress we can make on the imaging once the imaging experiments begin.

We have also made progress on the modeling effort. In evaluating the various existing potentials for aluminum, it has been determined that a few of the nuances of aluminum that could affect the general behavior producing ejecta at high pressure are not adequately captured by the existing EAM potentials. Electronic structure calculations have been performed in a way to identify where the aluminum potentials can be improved. Several large-scale simulations of copper structures have been performed looking at the behavior of sinusoidal surfaces with a small rotation angle. These simulations show how the slight difference in time of arrival of the shock followed by non-symmetric interactions of the rarefaction waves cause the resulting spikes to coalesce setting up non-shock normal particle momentum. Currently analysis is underway to characterize the particle size distributions in light of the theoretical predictions. Those simulations showing dynamic particle break-up are being analyzed to determine whether there is an approach to developing a model for particle velocity distributions to replace the current prescription approach currently implemented.

Future Work

This year we had significant set backs in the laser system for these experiments (see Past Year's Accomplishments). Therefore, for the remainder of FY14 the goal will be to optimize the high harmonic generation drive and single shot imaging and synchronize the laser shock drive so that we can begin dynamic imaging of shocked surfaces in FY15. The specific steps we will be taking include 1) optimizing the laser drive pulse energy, focus, and spatial mode for the best imaging parameters, 2) upgrading the optical components in the laser pulse shaper for the laser shock drive, and 3) optimizing the laser shock drive by conducting laser velocimetry with a MPA-CINT owned Pulsed Laser Velocimetry System currently on loan to W-Division. These efforts will pave the way for the first synchronized, shock pump – HHG imaging probe experiments where we plan on capturing sub-100 nm resolution dynamic images of the shock breakout on metal surfaces. Coupled with these experimental efforts, in the next year, a simple model for the distribution of the particle velocities will be proposed. We also expect that an aluminum embedded atom method potential will be refined in such a way to capture some of the nuances of aluminum near melt on the shock Hugoniot.

Conclusion

This project's goals are to image ultrafast laser shock driven ejecta particles and to compare the imaging data with molecular dynamics simulations. This project will demonstrate the first single shot coherent x-ray diffraction imaging of a dynamic process and will validate molecular dynamics simulations. Additionally, we will provide an important new experimental capability, x-ray imaging of dynamic events, and will create data on instability formation with unprecedented time and length scales.

Nuclear and Particle Futures

Exploratory Research
Continuing Project

In Search of Light WIMPs

Alexander Friedland
20130637ER

Introduction

Astrophysical and cosmological observations over the last two decades have proven that ordinary matter constitutes only a few percent of the energy density of our Universe. Most of the energy density is contained in dark matter and dark energy. While the dark matter is known to hold the galaxies together, its physical nature remains a mystery. Laboratory experiments aiming to detect the dark matter particle form one of the cornerstones of the worldwide campaign to discover new physics beyond the Standard Model. The search for dark matter is one of the stated priorities of the DOE Office of Science.

Traditionally, direct detection experiments have been guided by the so-called WIMP (Weakly Interacting Massive Particle) paradigm. In this paradigm, one expects the dark matter particle to be in the mass range of 100-1000 times the mass of the proton. Yet, in the past few years, a contradictory picture has emerged that appears incompatible with the minimal WIMP framework. Several experiments, specifically CoGeNT, CRESST-II, and DAMA, have claimed evidence for dark matter, whereas CDMS, XENON10, and XENON100 have reported null results. To untangle this paradox urgently requires simultaneous advances in both theory and experiment.

We will attack the physics of dark matter on two fronts: by scrutinizing theoretical models that go beyond the minimal WIMP framework and by performing a low-threshold search for dark matter using the Majorana Demonstrator experiment. The experiment will be carried out in the timeframe of this proposal and will result in the world's best sensitivity in the light dark matter window. The theory effort will analyze the experimental results in the broad context of existing searches and will translate them into the physical properties of dark matter in various scenarios of new physics.

Benefit to National Security Missions

The search for dark matter is one of the leading priori-

ties of the DOE Office of Science. The aim of this project is to enhance the capabilities of the Majorana detector to make it into the world's best probe of dark matter in the light mass window. Additional strategic impact derives from the capability of the Majorana detector in low-background counting. Improving this capability by going to lower energies will enable us to study a wider range of samples. We presently count samples for programs in HEP and NP that require fabrication of experimental apparatus from radio-pure parts. We have also counted a sample for NIF-related efforts.

Progress

The efforts are divided between a few activities, and our balance has changed due to two events; the reduction in support and the temporary, but ongoing, closure of WIPP. LANL was operating a low background detector pair at WIPP (Waste Isolation Pilot Plant) that were being used for data analysis technique development. The Majorana Collaboration operated a R&D prototype detector called MALBEK at KURF (Kimblerton Underground Research Facility) that produced some initial results on dark matter and plays the role of a prototype for our activities with the Demonstrator. Finally, the Demonstrator is being built at SURF (Sanford Underground Research Facility), with the initial prototype cryostat now under operation. All these activities are designed to improve our interpretation of the data from the Dem below 10 keV in order to search for low-mass WIMPs and solar Axions.

We were investigating the suitability of the optimum filter technique to lower the thresholds of high-purity point contact germanium detectors for rare-event searches at low-energy using the nicknamed COPPI detectors deployed in the WIPP facility. An optimum filter is essentially a matched filter technique that leverages an understanding of the noise and signal power spectra to build a transfer function optimizing a reconstructed variable of interest, such as energy response. We suc-

ceeded in building some demonstration code in python that interfaces with data from COPPI, and were in the process of implementing a faster library that integrates more closely with the Majorana analysis chain. At this time, our noise power spectra are modeled on standard noise spectra, such as gaussian and pink noise profiles. For the filter to be effectively applied in routine operation we will need to base our noise power spectrum on real data in order to capture the contributions specific to the COPPIs mechanical and thermal couplings to the lab environment. We have plans to implement a random trigger into the DAQ to acquire detector waveforms in the absence of a physics event. Due to the difficulties with access to WIPP and the need to reduce scope due to the lower support, we have tabled these activities. Specifically, the random trigger hardware test is not possible at this time.

The R&D detector at KURF has produced a limit on dark matter in the mass region below 10 GeV. A paper was prepared and initial results were shown at a conference last September. The paper has been finished and was submitted as a proceeding contribution to that conference ("A Dark Matter Search with MALBEK", LA-UR-14-23140). We have been building on that success by examining a new analysis technique for solar axion searches. The technique exploits the Bragg scattering signal from such axions that requires knowledge of the detector crystal axis orientation. Our new technique hopes to exploit relative knowledge of the axes between two crystals without explicit knowledge of the absolute angle to the sun. The later is difficult to determine precisely. We should determine within the next few months whether this idea has merits and is publishable. If it is successful, it is likely to be used during analysis of the Demonstrator data.

An initial theoretical study of the sensitivity of this experiment to light WIMP masses has been completed. The study uncovered a novel physical degeneracy between the WIMP mass and its velocity dispersion in our galactic halo. This implies there is a great need for accurate simulation of dark matter distribution in the galactic halo. The results are published in Physics Letters B. We have also realized that coupling between neutrinos and dark matter would have a profound impact on this distribution. We began investigating observational and cosmological implications of this scenario.

Future Work

On the experimental side, we will operate Cryostat 1 in late 2014 or early 2015. We expect to collect data to be used for the dark matter analysis. The prototype module is operating and would also have some dark matter sensitivity, however, its use has been dominated by the need

to be a test bed for technical tests. Due to the difficulties with access to WIPP and the need to reduce scope due to the lower support, we have tabled activities related to the random trigger hardware test. Our new technique hopes to exploit relative knowledge of the axes between two crystals without explicit knowledge of the absolute angle to the sun. The later is difficult to determine precisely. We should determine within the next few months whether this idea has merits and is publishable. If it is successful, it is likely to be used during analysis of the Demonstrator data.

On the theoretical side, we will analyze the phase-space distribution of dark matter coming out of high resolution supercomputing simulations. We will pay special attention to the high velocity tails of the distribution, where more structure is expected and which is most physically important for light WIMPs. We will also investigate a theoretical framework in which neutrinos are coupled to dark matter and explore the consequences of this coupling on the direct detection signal. Finally, we will derive quantitative bounds on neutrino-dark matter coupling from the latest IceCube and Deepcore data.

Conclusion

The project aims to carry out the world's most sensitive search for dark matter in the mass window of 5-100 proton masses, using the Majorana detector. It also plans to develop a theoretical framework for understanding the particle physics nature of dark matter, given the latest data from other direct detection experiments, LHC, IceCUBE, Fermi, and other relevant searches. The experimental and theoretical parts will be tightly integrated and the analysis of data will be done jointly.

Publications

- Cherry, J. F., A. Friedland, and I. M. Shoemaker. Neutrino Portal Dark Matter: From Dwarf Galaxies to IceCube. *Physics Letters B*.
- Friedland, A., and M. Shoemaker. Integrating In Dark Matter Astrophysics at Direct Detection Experiments. 2013. *Physics Letters B*. 724: 183.
- Giovanetti, G. K.. A Dark Matter Search with The MAJORANA Low-Background Broad Energy Germanium Detector. Invited presentation at TAUP 2013. (Asilomar, CA, USA, 9 Sep. 2013).
- Giovanetti, G. K., and S. R. Elliott. A Dark Matter Search with MALBEK. 2014. *Physics Procedia*. 00: 1.

Nuclear and Particle Futures

Exploratory Research
Continuing Project

Emittance-Reduction System for Future Accelerator Solutions

Kip A. Bishofberger
20130688ER

Introduction

More than any other measure, the beam brightness has been the driving force for technological development in beam physics. Until recently, the beam's "emittances" (the rms area in phase space, comparable to temperature) were considered constants of linear motion, and nonlinear forces only increased them, thereby reducing the beam brightness.

However, within the past couple of years, a breakthrough has developed, largely originating with scientists at LANL. The term "eigen-emittances" refers to the emittances that a beam would possess if there were no additional correlations. The new discovery is that, by generating a beam with specific initial correlations, the eigen-emittances can be substantially reduced, and through beam optics that unravel the correlations, the final, observed emittances will take on these improved values.

The technology development capability supported by this proposal enhances our ability to design Engineered Systems. Additionally, compact, advanced accelerator technology supports a wide array of accelerator-based solutions to National Security missions. Two examples include Global Security, such as Warfighter Support (high-power FELs) and Countering Weapons of Mass Effect (active interrogation).

Benefit to National Security Missions

Major accelerator facilities at LANL include LANSCE and DARHT, and successful implementation of the proposed MaRIE signature science facility will require developing new accelerator capabilities. Additionally, several emerging major Global Security work-for-other missions require state-of-the-art accelerator technology.

The work in this project directly supports future light sources (such as that proposed for the MaRIE XFEL) and future linear colliders, which are major DOE Office of Sci-

ence projects. In turn, light sources support the Materials: Discovery Science to Strategic Applications grand challenge and linear colliders support the Beyond the Standard Model grand challenge.

More directly, the technology development capability supported by this project enhances our ability to design Engineered Systems, another grand challenge. Additionally, compact, advanced accelerator technology supports a wide array of accelerator-based solutions to National Security missions. Two examples include Global Security, such as Warfighter Support (high-power FELs) and Countering Weapons of Mass Effect (active interrogation).

Progress

There were two unexpected roadblocks in the progress of this LDRD project. The project focus needed to change, and what were roadblocks have actually proven to be new opportunities to expand the relevancy of the project's results.

Firstly, the facility initially selected for the demonstration was unable to accommodate testing time in their schedule. The LANSCE facility at LANL is an accelerator-based user facility, running 800-MeV protons for a variety of experiments and production needs. At the beginning of this project, the LANSCE facility coordinator blocked beam time for this project. But the accelerator was not functional for other needs, putting pressure on experimental beam time, and there was not enough time for a full demonstration of the setup. The results of this issue were as follows:

- A new facility, the Argonne Wakefield Accelerator (AWA) became available.
- AWA runs 75-MeV electrons, an entirely different regime for the proposed demonstration. While requiring additional simulation optimization, it doubled the amount of optimizations the project has produced. Publishing these results broadens the ap-

plicability of the funded work on future facilities.

- Additionally, AWA has a higher-quality beam and higher-quality diagnostics. With the newer technology AWA can provide, we believe the data will be much more compelling, and tests on a variety of parameter spaces can be compared.

Secondly, the AWA underwent a significant upgrade over the past 6 months. This pushed our beam time into the next fiscal year. However, the upgrade enabled more improvements:

- The initial diagnostic system was not fully functional, and part of our beamtime was to complete that system. The delay allowed the system to be fully tested beforehand. This reduced risk and reduced cost to the program.
- The AWA is now a testing facility within the Accelerator Stewardship Office in the Office of Science. Two user meetings have already occurred, and experiments are being reported to the Office of Science. This means the current project has already had additional exposure to the outside community, and will continue to be advertised at high levels.

In all, what appeared to be initial roadblocks turned out to be a fantastic growth in this project. The project itself completed a variety of simulation results, initiated beamline component construction, and solidified the demonstration timeline with AWA. The improved diagnostic system and the exposure to the Office of Science are also welcome complementary developments during the past year.

Future Work

During the next year, this project intends to test the final beamline configuration. This involves several steps:

- Completion of the beamline construction, which was started this year. For example, several foil materials and designs will be available for testing. Several custom magnets will be installed on the beamline.
- Testing of the foil for eigen-emittance partitioning. Simulations of the beam-on-foil properties have been performed, but verifying these characteristics are crucial for a final demonstration.
- Testing of the full beamline insertion device. The exciting results are anticipated to alter the beam properties (emittances) due to unique foil properties. Observing these effects will be new research which numerous accelerator facilities have expressed great interest in

exploring.

- Publication of these results is an important step for cutting-edge research. By the end of the year, the project will have demonstrated an optimized emittance-reducing scheme which is scalable to numerous types of accelerator and beamline applications.

Conclusion

This project intends to develop a new, revolutionary concept in accelerator physics. In particular, theory has shown that setting specific correlations within the particle distribution, and finally unraveling those correlations, the final transverse emittances will be superior to previous capabilities. This project intends to demonstrate and optimize this technique, in order to generate particle beams of exceptional brightness.

Updates to existing accelerator facilities (such as LANSCE and DARHT), future construction of the MaRIE signature-science facility, and Global Security missions all depend on the technology of this project.

Nuclear and Particle Futures

Exploratory Research
Continuing Project

Hybrid Shock Ignition as an Alternate Concept for Fusion Energy

Eric N. Loomis
20140180ER

Introduction

Achieving energy gain from thermonuclear reacting plasmas in a laboratory setting is a fundamental aim of researchers around the world since, in time, it would lead to a new and controllable energy source, as well as a much needed platform for supporting aspects of Stockpile Stewardship. Inertial Confinement Fusion (ICF) has remained at the forefront of this research for many years and its flagship, the National Ignition Facility (NIF), is currently performing the experiments towards ignition anticipated for well over a decade. In the past year, however, thermonuclear ignition on NIF using conventional indirect-drive ICF has proven more elusive than previously expected. Even if ignition is achieved, new high yield concepts are needed for useful energy production as well as future “Applications of Ignition” experiments. In this project we present a novel platform with the potential for high energy gain implosions, which integrates the existing advances made in Indirect-Drive Inertial Fusion with the promising new scheme of Shock Ignition (SI). If successful, our Hybrid SI concept will provide a new platform by which to study hohlraum-based implosion physics, but which accesses different conditions than current NIF ignition attempts and stresses different aspects of our predictive capabilities, which we expect will lead to improved physics models in numerical radiation hydrodynamics codes.

Hybrid SI will use spherical hohlraums with a novel arrangement of symmetric laser entrance holes that allow both indirect-drive beam access to the hohlraum walls followed by shock ignitor drive beams that directly illuminate and provide requisite heating to the compressed fuel. Our exploratory research into this concept will involve multi-dimensional radiation hydrodynamics design calculations and proof-of-principle experiments that demonstrate adequate implosion and ignitor symmetry. Although the long-term goal is to field experiments on NIF, we will perform the initial development at the OMEGA laser facility (Univ. of Rochester, NY).

Benefit to National Security Missions

Alternate Inertial Confinement Fusion (ICF) concepts, such as Shock Ignition (SI), will stress different aspects of the ignition problem compared to conventional indirect-drive and will help elucidate shortcomings in our predictive capabilities. This platform is also a potential low convergence design that at ignition-scale could out-perform current NIF implosions or at least be more predictable. This work addresses a major gap: LANL is currently the only major ICF laboratory without an investment in SI and, furthermore, LANL is the only ICF laboratory without an investment in any alternative ignition platform. The intent of this project is to begin to build an innovative Hybrid SI program with potential experiments on NIF within four years.

Progress

In the first year we have begun 2-D design calculations of the OMEGA Hybrid shock ignition targets. We started by performing validation of simulations on a related experiment conducted previously on the OMEGA laser. This validation informed us of the accuracy of our 2-D modeling efforts of laser ray tracing inside gold hohlraums in spherical geometry and the resulting radiation temperature distribution that performed the compression of the fuel capsule. We are currently extending these validated simulations to the current project hohlraum and capsule geometry where high resolution hohlraum simulations are performed, which then link to the RAGE simulation package to perform the capsule hydrodynamic evolution. Evan Dodd and his post-doc Jessica Baumgaertel are teaming together to perform these simulations.

The experimental design for first experiments was completed, which includes the geometries of all diagnostics, lasers, and targets using the design tool VisRAD. We have performed detailed sensitivity studies of our experimental design to such things as beam and target misalignments in the real OMEGA chamber environment. These have led to some modifications of our

original target geometry.

Integrated simulations were performed with the radiation hydrodynamics code HYDRA, which can apply asymmetric radiation flux boundary conditions. Legendre polynomials of radiation flux was extracted from VisRAD calculations of our 3-D target geometry and used in HYDRA simulations. A parameter study was then conducted to check the affect of ignition beam timing on neutron yield and fuel ion temperature under conditions of realistic asymmetric radiation flux.

We also worked with MST-7 to generate an actual target design, which consists of the finer target details such as capsule mounting stocks inside the hohlraums and fuel gas fill tubes. With MST-7 target fabrication engineers we have devised a path forward on how to fabricate the complex hohlraums and are beginning the initial fabrication of target components.

Future Work

We were not awarded facility time under the OMEGA laser Laboratory Basic Sciences (LBS) program so experiments are not expected until FY16. For this reason we will now focus our FY15 efforts on detailed 2- and 3-D simulations of our Hybrid Shock Ignition platform. With this added time we will be able to more completely address the design aspects of laser-plasma coupling and drive asymmetry effects on our targets. We will also begin new designs for ignition-scale targets at the National Ignition Facility (NIF). Another key priority in FY15 is to complete the full fabrication and assembly of actual experimental targets for the OMEGA facility. These targets are expected to be difficult to manufacture so starting now will provide time for improvement in fabrication methods. We will also perform detailed calculations to predict diagnostic data output resulting in synthetic data of our experiment. This will aid in the experimental design and allow us to optimize targets and diagnostics to deliver high quality data once experiments are performed.

Conclusion

Success of this project is based on demonstrating the novel integration and nuclear performance benefit of a hohlraum-driven implosion with direct-drive Shock Ignition of the fuel. Specifically, the outstanding questions that must be addressed to declare success regards the achievable symmetry of the hohlraum-driven capsule implosion and the symmetry that must be attained by the ignitor beams to result in enhanced nuclear performance (neutron yield, ion temperature, and areal density) beyond standard implosion techniques. We will also produce ignition-scale design calculations in order to predict feasibility for NIF.

Nuclear and Particle Futures

Exploratory Research
Continuing Project

Quantum Kinetics of Neutrinos in the Early Universe and Supernovae

Vincenzo Cirigliano
20140252ER

Introduction

Neutrinos are perhaps the most mysterious and elusive of the known particles, and yet play a crucial role in the early universe and the life of stars. Neutrinos interact only very weakly and have tiny masses, the heaviest neutrino being at least a million times lighter than the electron, the lightest charged particle. Moreover, observations of solar, atmospheric, reactor, and accelerator neutrinos indicate that the neutrinos come in three different flavors, that can morph into one another as they evolve, through a genuine quantum mechanical interference effect. Despite their elusive nature, neutrinos play a special role in the dynamics of the early universe (EU) and supernovae (SN), because they come in huge numbers and because through their flavor-dependent weak interactions they can set the ratio of neutrons to proton in both the EU and in the heated ejecta of a supernova. Such ratio is a key ingredient in understanding quantitatively what atomic nuclei are synthesized in these two environment.

The overarching goal of this project is to set up the analytic and computational tools needed to describe neutrino kinetics in the EU and SN environments, simultaneously keeping track of the effect of quantum mechanical morphing and the role of inelastic collisions with the medium. The appropriate tool to describe neutrino evolution in a hot and dense medium are the so-called Quantum Kinetic Equations (QKEs). To date, no self-consistent derivation of the QKEs exists, let alone numerical solution. Our proposed research will improve on the current state-of-the-art in two important aspects: first, it will provide a first-principle derivation of the QKEs, based on non-equilibrium field theory and a controlled expansion in ratios of widely separated length scales.

Benefit to National Security Missions

Understanding how neutrinos have shaped the evolution of the cosmos and of stars, including the implications for the synthesis of atomic nuclei, is a major goal of both

the Nuclear Physics and High Energy Physics Office of Science.

Moreover, our project will develop cutting edge capability in transport theory. While this will be applied to neutrinos in supernovae and early universe, in the future the very same tools could be applied to programmatic work supporting our national security mission.

Progress

In the past nine months the project has proceeded along several fronts, which we highlight below:

Firstly, we completed the formulation of Quantum Kinetic Equations for neutrinos starting from first principles, i.e. quantum field theory. The results have been published by the PI and external collaborators Fuller and Vlasenko in *Phys. Rev D* 89 (2014) 105004. In this paper, we present a formulation of the quantum kinetic equations (QKEs) which govern the evolution of neutrino flavor at high density and temperature. Here, the QKEs are derived from the ground up, using fundamental neutrino interactions and quantum field theory. We show that the resulting QKEs describe coherent flavor evolution with an effective mass when inelastic scattering is negligible. The QKEs also contain a collision term. This term can reduce to the collision term in the Boltzmann equation when scattering is dominant and the neutrino effective masses and density matrices become diagonal in the interaction basis. We also find that the QKE's include equations of motion for a new dynamical quantity related to neutrino spin. This quantity decouples from the equations of motion for the density matrices at low densities or in isotropic conditions. However, the spin equations of motion allow for the possibility of coherent transformation between neutrinos and antineutrinos at high densities and in the presence of anisotropy. Although the requisite conditions for this exist in the core collapse supernova and compact object merger environments, it is likely that only a self consistent incorporation

of the QKEs in a sufficiently realistic model could establish whether or not significant neutrino-antineutrino conversion occurs

Given the novelty of the above result, we have proceeded to an alternative derivation of the new terms involving the neutrino spin degrees of freedom. We are currently finalizing a new manuscript that summarized this alternative derivations, together with a summary of the main results of the long paper (Phys. Rev D 89 (2014) 105004). We plan to submit the new manuscript to Physical Review Letter.

Secondly, we started numerical simulation work to explore in which regime there can be large conversion of left-handed into right-handed neutrinos due to the new term of the QKEs that we have found. Preliminary calculations indicate that the conditions for large scale conversion do exist in the supernova envelope. We plan to write these results in another paper, to be submitted to Physical Review Letter.

Finally, we have also started a systematic analytic calculation of the so-called “collision terms” that appear in the QKEs. While the structure of these collision terms has been identified in Phys. Rev D 89 (2014) 105004, our next task is to provide an explicit form in terms of the neutrino density matrix and the calculable response function characterizing the medium in which neutrinos propagate. Once we complete this analytic calculation, we will have “practical” QKEs that can be fully implemented in a numerical code.

Future Work

- Obtain complete closed expressions for the collision terms, valid both for the Early universe isotropic conditions and for anisotropic conditions relevant to compact astrophysical environments.
- Perform numerical simulations of the full quantum kinetic equations (QKEs) describing the evolution and decoupling of neutrinos in the early universe. We plan to do this both for the case of three active neutrinos and for the case of active-sterile mixing.
- Building on the results of point (2), we will begin to explore the implications of the decoupled neutrino spectra on the process of primordial nucleosynthesis, i.e. the making of light nuclei in the early universe.

Conclusion

The proposed research will enable us to address two sets of outstanding questions:

1. What is the energy and flavor composition of neutrinos about 1 sec after the Big Bang, when the light nuclei

are first synthesized? How does this knowledge constrain the existence of possible new neutrino states, so called “sterile” neutrinos?

2. How do inelastic collisions affect collective flavor transformation in a supernova envelope? What are the consequences for the synthesis of heavy elements in the neutrino-heated supernova ejecta? What are the consequences for the neutrino signal that can be potentially detected from galactic supernovae?

Publications

Cirigliano, V., G. M. Fuller, and A. Vlasenko. A new spin on neutrino quantum kinetics. *Physics Letters B*.

Vlasenko, A., V. Cirigliano, and G. M. Fuller. Neutrino quantum kinetics. 2014. *Physical Review D*. 89 (105): 004.

Vlasenko, A., V. Cirigliano, and G. M. Fuller. Prospects for neutrino-antineutrino transformation in astrophysical environments. To appear in *Physical Review Letters*.

Nuclear and Particle Futures

Exploratory Research
Continuing Project

Designing the Next Generation Compton Light Source

Nikolai Yampolsky
20140269ER

Introduction

The ultimate goal is to prove the feasibility of the new technology for light sources based on inverse Compton scattering using microbunched electron beams. In this setup the scattered light will be coherently amplified since the radiation generated by each microbunch adds up in phase. The idea has never been explored since there was no recognized mechanism for creating very short wavelength density modulations in relativistic electrons beams with relatively low energy (~100 MeV). We propose to create the beam distribution consisting of several well separated energy bands through a series of manipulations with the bunch phase space using laser modulation and conventional electron beam optics. Such a distribution will drive the two-stream instability resulting in the plasma wave, i.e. density modulation. The proposed scheme can be split into three well separated stages, namely (1) creating required beam distribution, (2) development of the two-stream instability causing beam microbunching, and (3) scattering laser pulse off the microbunched beam to produce radiation with increased coherency. We will study each of these stages and analyze start-to-end performance of this novel scheme. We anticipate finding the parameters region for which the novel scheme results in 5-6 orders of magnitude increase in brightness over existing Compton light sources in 1-10nm wavelength range.

The largest challenge of this project is in mitigating various deleterious effects which may suppress the instability leading to beam microbunching. Preliminary analysis shows that they are negligible at large wavelengths (on the order of 1 micron) and dominant at small wavelengths (on the order of 1 nm). During the course of the project we will identify the precise limit of the novel technology.

Benefit to National Security Missions

If successful, the project will lead to development of a new generation soft X-ray Compton light source having

significantly better beam quality over existing ones. This source will be compact (~100m) and relatively cheap (less than \$100M), which makes it suitable to be widely distributed to multiple national laboratories and major research universities. The high brightness, tunability, and short duration of these sources will allow for many experiments which currently have to be conducted at the 3rd and 4th generation light source facilities which are severely overbooked. Development of a cheap, competitive, high brightness soft X-ray light source will cover several national light source needs and will boost many research areas such as Biology, Chemistry, Physics, and Material Science.

AOT division is currently designing the Injector Test Stand (ITS) needed for testing novel ideas in Beam Physics required for successful commissioning of the MaRIE hard X-ray free electron laser (FEL). The ITS can potentially be used as a Compton source for enabling early MaRIE related experiments prior to construction of the FEL both for refining MaRIE FEL parameters and for providing additional FEL justification and motivation. The capability developed through this proposed work will allow a larger number and breadth of preliminary experiments to be done. This source can be used even after the commissioning of MaRIE FEL, adding a complementary soft X-ray capability to the facility.

Progress

In first nine months of FY14 the progress of the project was consistent with the anticipated research plan. The progress was made in two major parts, namely (1) design of the beamline which provides unstable beam distribution, and (2) analysis of the instability.

The beamline was successfully designed and simulated using realistic beam parameters. The appropriate numerical diagnostics was developed to provide useful metric for estimating the performance of the beamline. The beamline performs perfectly at low beam cur-

rents but shows degradation of the beam and modulation parameters while the current increases due to coherent synchrotron radiation (CSR). This effect was anticipated at the proposal stage but the effect turned out to be more significant than expected. Several ways of its mitigation were tested but we were not able to reduce it as much as we hoped. Currently, alternative beamline is investigated for reducing the effect of CSR.

PIC simulations were performed to study the development of the two-stream instability in modulated beam. The convergence study in 1D geometry has been done. Currently, we investigate the accuracy of the analytical predictions by simulating the artificial beam distribution for which the analytical result was obtained. We anticipate finishing this study by the end of FY14. By that time we will also make first start-to-end simulations. At that stage there will be concluded whether the deleterious CSR effects actually reduce performance of the scheme or more our diagnostics shows numerical artefacts.

Future Work

- 3D simulations of the instability
- Detailed start-to-end simulations using output of EL-EGANT as an input for CPIC
- Include intra-beam scattering into CPIC
- Optimize performance of the scheme resulting in the largest growth of the modulation
- Estimate the limit of the technology in terms of the shortest wavelength modulation which can be produced.

Conclusion

- Perform detailed study of the two-stream instability in relativistic beams driven by the multi-stream distribution. Support conclusions with detailed analytical estimates and numerical simulations including all relevant effects.
- Determine whether this mechanism for the microbunching instability may be used for improving quality of the Compton light source. Provide reliable quantitative estimates of the resulting source parameters.
- Determine whether this mechanism for microbunching may be significant in other applications in Accelerator Physics, e.g. seeding schemes for free electron lasers (FELs).

Publications

Yampolsky, N. A., G. L. Delzanno, C. Huang, and D.

Shchegolkov. Two-stream Instability at Soft X-ray Wavelengths for Increasing Brightness of Compton Sources. Presented at 35th International Free-Electron Laser Conference. (New York, NY, 25-30 August, 2013).

Yampolsky, N. A., G. L. Delzanno, C. Huang, and D. Shchegolkov. Two-stream Instability at Soft X-ray Wavelengths for Increasing Brightness of Compton Sources. Presented at North American Particle Accelerator Conference. (Pasadena, CA, 29/09/ - 4/10, 2013).

Yampolsky, N. A., G. L. Delzanno, C. Huang, and D. Shchegolkov. Two-stream Instability at Soft X-ray Wavelengths for Increasing Brightness of Compton Sources. Presented at 55th Annual Meeting of the APS Division of Plasma Physics. (Denver, CO, November 11-15, 2013).

Nuclear and Particle Futures

Exploratory Research
Continuing Project

Combined Klystron and Linac (Klynac)

Bruce E. Carlsten
20140351ER

Introduction

We propose an engineering prototype demonstration (Technology Readiness Level (TRL) of 5) of a novel accelerator system architecture, where the accelerator's RF power source is integrated with the accelerator structure itself. Using a klystron as the RF power source, we have named this architecture "Klynac" to represent the functionalities of both the klystron and linear accelerator (linac) parts. To quantify its potential impact, the Klynac technology may lead to a reduction of a factor of 5 to 10 in over-all weight of portable radiography systems when used with an existing LANL TRL 6 capability, the resonant air-core transformer (compared to the 1900-lb, 3-MeV Varian Linatron M3, intended for fixed or truck-mounted applications). The reduced weight and size of the Klynac will allow man-portable radiographic missions, including emergency response, and provide a new technology to reduce the cost of medical radiography systems.

Benefit to National Security Missions

We will develop a technology that can be used to reduce the size of portable MeV-class radiography systems (including those used for medical cancer treatments) from ~ ton weights to a few hundred pounds. The NA-22 roadmap "Special Nuclear Materials Movement Detection Program Radiation Sensors and Sources Roadmap" calls for high-repetition-rate linacs (1–10 kHz) to increase photon flux compared to traditional linacs, allowing detection of both prompt and delayed signatures. The roadmap specifically calls for development of next-generation accelerator concepts and development of compact, mobile photon sources, which can be addressed with the technologies developed by the proposed work. The Laboratory is not receiving any NA-22 funds to address this goal.

Progress

During this last fiscal year, we performed beam dynamics and beam/RF interaction design studies using the LANL

particle-in-cell code ISIS. We modeled RF generation in the klystron section, interception of 99% of the beam current in the transfer section (reducing the beam current from 10 A to 0.1 A), and acceleration of the remaining current in the linac section. We developed electron gun specifications and are finalizing a contract to get a gun with these specifications built and delivered to us by Dec 2014. Also, we already have a contract in place for translating our RF design (which is the locations of eight RF cavities - four for both the klystron and linac sections - and their gap voltages) to an actual physical design with the required coupling between cavities. We will have the RF structure design delivered by the end of FY14 and will have the RF structure fabricated by March 2015. Modeling has confirmed that the klystron section of the device should be able to produce 250 kW of power, which should be sufficient to accelerate the 0.1 A current to just under 1 MeV. Due to a 8.9% funding cut to the project, we had to delete the intermediate "beam stick" test deliverable. Although elimination of this step does increase overall project risk (by eliminating our ability to make an early identification of problems and addressing them), we are still on track to finish completion and testing of the klynac by the end of FY15.

Future Work

We designed the klystron and linac sections this fiscal year using the LANL PIC code ISIS and let contracts for the fabrication of the electron gun and the overall klynac structure RF and mechanical designs. Our first contractor will use TRAK to design the electron gun (delivery Dec 2014) and our second contractor will use HFSS for the structure RF design. In FY15, we will receive and assemble the parts. Using the LANL CLIA modulator, we will operate the device and measure electron beam acceleration with a spectrometer.

Conclusion

The main technical goal of this project is to demonstrate that a portion of the bunched klystron beam can be ac-

celerated in a linac. For this demonstration, a low voltage resonant klystron and linac will be built, driven at 50 kV and accelerating the electron beam to 1 MeV. The S-band linac design is standard, and will be identical to that used in the previous linacs. Likewise, the electron gun design and the 4-cavity klystron design will follow standard design practices.

Nuclear and Particle Futures

Exploratory Research
Continuing Project

Multi-GeV Electron Radiography

Frank E. Merrill
20140591ER

Introduction

This project will investigate the potential for multi-GeV electron radiography to provide high spatial and temporal resolution measurements of dynamic materials at the multi-probe diagnostic hall (MPDH) proposed at the Matter and Radiation in Extremes (MaRIE) facility. This technique has been proposed as one of the major diagnostics on the MPDH, but has not yet been experimentally demonstrated. We plan to design an imaging system to utilize the multi-GeV beams at Stanford Linear Accelerator Center to test the concepts and performance of high energy electron radiography. Although this type of imaging has been demonstrated with MeV-GeV protons, it has never been attempted with high energy electrons. The demonstration of this measurement capability would provide a new window into the dynamic process of opaque materials at unprecedented time and length scales. This new window would allow a more fundamental understanding of material response to extreme environments such as is experienced within a functioning nuclear weapon system.

Benefit to National Security Missions

This work will test the concept of using multi-GeV electrons for radiography of thin dynamic systems. This concept is a major pillar of the proposed Multi-Probe Diagnostic Hall at the Matter and Radiation in Extremes (MaRIE) facility. It is envisioned that these high energy electrons will be used to study materials relevant to the future weapons program, measuring fundamental materials properties with very high temporal and spatial resolution. The successful development of this technology will support the fundamental material research efforts within the DOE Office of Science and the fundamental and applied research in the nuclear weapons program for both inert as well as reactive materials such as high explosives. This capability to measure dynamic material response will also be applicable to DOD programs for military applications.

Progress

In the first quarter of this project a conceptual design of the electron radiography system has been completed using “standard” magnetic optics components available at the Stanford Linear Accelerator Center (SLAC). The analytic analysis of this system shows that this configuration will exceed the performance requirements for these measurements. Preliminary Monte Carlo simulations confirm these calculations. The next step is to work with SLAC staff to determine how to implement this configuration at SLAC, perform detailed Monte Carlo simulations to fully characterize the system performance and develop a conceptual design for an image collection system for future experiments. This project started in the third quarter of fiscal year 2014 and is on track to meet the fiscal year 2014 goals.

Future Work

In the second year of this project we will:

- Determine the requirements for implementation of the imaging system at SLAC.
- Work with SLAC staff to identify a path forward to field this system.
- Install the imaging system at NIF.
- Further develop tools to simulate this diagnostic technique.
- Design an image collection system.

Conclusion

We plan to design, assemble and test the first ever Multi-GeV electron radiography system. These measurements will focus on characterizing the performance of this type of radiography system as well as identifying the fundamental limitations of this technique. This effort will provide important information for the MaRIE project in determining the electron radiography capabilities as well as specifying the requirements for a future facility.

Publications

Merrill, F.. Imaging with penetrating radiation for the study of small dynamic physical processes. Laser and Particle Beams.

Nuclear and Particle Futures

Exploratory Research
Continuing Project

Photocathodes in Extremes: Understanding and Mitigating High Gradient Effects on Semiconductor Cathodes in X-FELs

Nathan A. Moody
20140616ER

Introduction

At the frontier of many scientific disciplines is the goal to understand, and even control matter, especially when it is subjected to extreme and dynamic conditions, such as those encountered in combustion, explosions, or other excursions in temperature and pressure. The ideal tool to probe matter in such extreme conditions is what has become known as an x-ray laser, or x-ray free electron laser (X-FEL). An X-FEL produces pulses of light (coherent hard x-rays) with a wavelength comparable to the distance separating atoms in solid materials and a pulse duration nearly as short as the changes which occur in materials, such as the formation and breakage of chemical bonds. Consecutive pulses of these hard x-rays would allow movies to be made of atoms or molecules, providing first-ever crucial information about how matter interacts under extraordinary environmental conditions. Any FEL relies upon a very strictly defined electron beam and what stands in the way of building an X-FEL light source like the one described above is the lack of sufficiently bright electron beam. Designs for such a beam exist but call for electron beam sources (cathodes) with performance that has never been proven or verified. These large scale X-FEL instruments are very costly and time consuming to construct, thus their design should be built on known facts regarding electron beam source performance and capability. The dominant question regarding most X-FEL designs relates to the maximum electric field strength it can be exposed to (and for how long) before the material breaks down due to the stress of the extreme electric field (> 100 MV/m). This project answers the question of whether present-day cathodes can survive high electric field gradient and it also presents methodologies for addressing and mitigating this risk.

Benefit to National Security Missions

MaRIE: This project addresses the highest risk element in Matter-Radiation Interacting in Extremes (MaRIE) x-ray free electron laser (X-FEL) design: the unknown effect

of high field gradient on semiconductor photocathodes. Because these effects irreversibly damage the emitted electron beam, they impact nearly every other aspect of an X-FEL design and must therefore be rigorously and experimentally understood, quantified, and mitigated before such designs mature beyond the conceptual stages. This project accomplishes all these goals.

DOE/DOD/SC: all next-generation light sources require a high brightness electron beam source. This research will answer fundamental questions concerning the behavior of cathodes under extreme conditions. The results will include fundamental research validating the basic approach to electron beam source design, and demonstrations of the enabling technology required to successfully utilize those cathodes in next generation light sources, user facilities, or weapons systems. We identify key technical challenges and solutions which simplify FEL designs and/or reduce the commissioning and operation costs significantly.

Basic Understanding of Materials: x-ray free electron lasers (X-FELs) are the ideal tool to interrogate, understand, and even control matter in extremes. To date, nineteen Nobel Prizes have been awarded for x-ray science using beam-based x-ray light sources, and we can expect more in the future as these tools open vast science frontiers to probe matter-in-extremes at unprecedented temporal, spatial, and energetic scales. The work represented in this project closes critical technology gaps in the fielding of X-FELs as instruments of discovery science.

Progress

The overarching goal of this project is to understand, quantify, and mitigate the effects of high electric field gradient at the surface of semiconductor cathodes in high performance electron injectors. Semiconductors are becoming a preferred material for launching an electron beam at high energy and high charge per bunch, but the

upper limits of this technology have not been quantifiably explored in terms of electric breakdown. This information is needed, however, in optimizing the designs of future advanced accelerators. Progress toward this goal involves growing relevant cathode samples and then controllably exposing them to high electric fields (up to 140 MV/m) for pulse durations ranging from sub-microsecond to 10 microseconds and beyond. At some point, it is expected that sufficiently high electric fields are able to remove material from the cathode surface leading to failure of the cathode, which is termed electric breakdown. Several underlying engineering challenges must be addressed in this project, including the design and fabrication of the resonant cavity test structure and the so-called radio-frequency (RF) seal surrounding the cathode, which enables the cathode assembly to act as an integrated part of the test structure.

Progress this first year is occurring as planned. Two surrogate cathode films were prepared this year and are undergoing baseline characterization tests in the 4Q FY14. The characterization studies consist of low-electric field measurements of efficiency as a function of incident light wavelength (a metric referred to as spectral response) in a controlled environment. These initial measurements will later serve as the baseline comparison to those taken in a high electric field environment in the resonant cavity test structure. The requisite experimental hardware and data acquisition systems were also assembled and manually tested. We have thus established and verified the essential capability to perform cathode fabrication and characterization tasks in the remaining years of this project.

The cavity test structure (in which cathodes will be exposed to high electric field) will be made of dispersion-strengthened copper metal and will consist of a single cell resonant in the L-band portion of the microwave frequency spectrum. Our first step in designing this structure has been completed: preliminary two dimensional modeling of a candidate test cell, for two alternate power coupling configurations. RF power must be coupled into the structure in order to establish the standing wave electric fields which are needed for the study. We have identified two ways to reliably couple the request RF power into the cavity, each offering distinct advantages. In 4Q FY14 we will down-select between these two methods and produce engineering designs which can be turned over to metal fabricators. The design of the cavity structure itself incorporates a novel difference which yields significant risk reduction to the entire project: we have separated the vacuum seal and the RF seals within the cavity. This is significant because it allows us to optimize each seal to perform its individual duty well (e.g., the vacuum seal does not have to function as an RF seal and vice versa).

The simulations we have performed indicate the required on-axis field of 140 MV/m can be readily achieved with the RF power source available to us (e.g., a high power klystron). Further, the cathode is situated at the peak-field location in the cavity, minimizing the probability of field emission damage to candidate cathodes. Full three dimensional modeling will commence shortly to facilitate a down-select between the coupling methods mentioned above. Figures-of-merit include maximum surface fields, coupling tunability, robustness, field-of-view of the cathode (necessary for illuminating it with laser light for photoemission), and field symmetry at the cathode. These studies will be completed at the end of FY14 and will allow for cavity fabrication to be completed early FY15. Procurement of key components in the cavity test structure has already begun and will facilitate timely completion of the fabrication of the test structure.

In short, the progress during FY14 was according to schedule and included cathode film fabrication, data acquisition setup, procurement of key hardware components, 2D design of the cathode RF seal, 2D design the resonant cavity test structure and its RF power coupler, and a novel method for separating the roles of the RF and vacuum seal in the structure itself.

Future Work

RF Cavity Fabrication

Having obtained a cavity design for a single cell RF test structure during FY14 (which includes our novel concepts of modularizing key components), we will proceed to fabricate the structure, which includes: the test cell itself, its on-axis RF coupler, and the cathode RF joint.

Milestone: A completed and assembled RF structure, mounted on a hard-back breadboard system, ready for low power testing.

RF Cavity Testing

We will demonstrate basic functionality and suitability of cavity structure: RF coupling, cavity resonance, coupling co-efficient, RF joint compatibility, initial cathode integration using instrumented metallic surrogate, and low power characterization of RF cavity.

Milestone: Report data on each of the metrics listed above.

Cathode Fabrication

Success in this project is defined as determining the upper damage threshold limit in terms of electric field gradient of semiconductor photocathodes in relevant test environment. Therefore, having a library of photocathode test samples is very important. Two cathode samples were fabricated in FY14 and progress in continuing to build a

sample library will continue in parallel with RF cavity fabrication.

Milestone: fabricate at least two additional semiconductor (multi-alkali) photocathode samples on relevant substrates that are ready for testing in the RF cavity environment.

Characterization of Cathode Samples

Milestone: collect data on each cathode sample fabricated in FY15 (current vs. voltage curves and quantum efficiency) prior to cavity testing.

Conclusion

This research will answer fundamental questions concerning the behavior of electron beam sources (namely, upper limit of electric field) when subjected to the conditions associated with an electron beam based x-ray free electron laser (X-FEL). The results will include both fundamental research validating the basic approach to designing electron beam sources, and/or demonstrating the enabling technology required to successfully utilize those cathodes in a specific X-FEL design. Key technical challenges and solutions, such as cathode seal geometry and high electric field surface treatment, will emerge and the data will allow future X-FEL designs to be based on validated test results.

Publications

Lewellen, J. W., and N. A. Moody. High gradient cathode testing for MaRIE. 2014. In FEL2014. (Basel, Switzerland). , p. THP024. Basel, Switzerland: JaCOW.

Moody, N., H. Yamaguchi, G. Gupta, and A. Mohite. Graphene shield-enhancement of photosensitive surfaces and devices. 2014. Micro- and Nanotechnology Sensors, Systems, and Applications VI. 9083 (6): 9083331.

Petascale Kinetic Plasma Simulation of the Interaction Among Laser Speckles in Nonlinear Optical Systems

Lin Yin
20120153ER

Abstract

When lasers propagate through plasma media, they may excite laser-plasma instabilities, where plasma waves grow rapidly, extracting energy from the laser and scattering the light. The physics governing the growth and saturation of these instabilities presents a very complex, nonlinear optics problem, as instability growth in one laser “speckle,” or a bright spot of the beam, can affect how the instability grows in neighboring speckles, which can in turn affect the growth in the original speckle. These complicated networks of speckles, coupled through the exchange of hot electrons and light waves, have complex, multi-scale, “emergent” properties that can only be understood by examining the physics on multiple scales—from the very smallest scales of individual wave-particle dynamics all the way to the macroscopic scale of a large laser beam comprising many speckles.

In this project, we used two- and three-dimensional kinetic simulations to bridge these scales and significantly advance the understanding of the physics of laser-plasma instabilities [1-5]. We also were able to develop reduced models of the dynamics, allowing prediction of the regimes of the greatest risk to laser-plasma instabilities in inertial fusion experiments, a result of profound scientific and practical importance, as control of such laser-plasma instabilities underpins our ability to achieve fusion ignition or field meaningful high-energy-density physics experiments at the National Ignition Facility.

Background and Research Objectives

Understanding the nonlinear optics of plasmas has been identified as a high energy density physics grand challenge. Decades of research have shown that this problem plays host to a wide range of complex physics processes and that the complexity of the problem presents an ideal platform for advancing fundamental, discovery-class science in multi-scale, emergent, nonlinear physics. This problem has only recently become tractable compu-

tationally with the growth of supercomputing power and simulation codes that have co-evolved to where ab initio exploration of the underlying physics is possible.

With Petaflop-class supercomputers, the investigators have advanced the understanding of the basic physics of stimulated Raman scattering in solitary laser speckles, the irreducible “building blocks” of intensity structures found in laser beams. If laser speckles do not meaningfully interact with one another, then a knowledge of single-speckle behavior and the statistics of speckle intensities would be all that’s needed to craft a macroscopic model of plasma behavior: a large laser beam with hundreds of thousands of laser speckles would act merely as the sum of the contributions of the constituent speckles (plus a relatively tame background contribution).

However, this is not the case. Laser speckles have been shown by the researchers to interact nonlinearly with one another. As a consequence, “meso-scale” modeling is essential because small aggregates of laser speckles may interact with one another, causing the system to exhibit emergent behavior—i.e., behavior in the aggregate that’s fundamentally different from the sum of individual speckles. One way that this happens is through the exchange of particles and waves among laser speckles: an intense speckle in an environment with other speckles nearby could “destabilize” those neighbors, resulting in enhanced emission of particles and transmission of wave energy from those speckles back to the original speckle, thus affecting its behavior nonlinearly and non-locally.

In our research, we examined speckle interaction in first-principles computer simulations of both modest and large ensembles of laser speckles. We applied the LANL VPIC particle-in-cell code and performed simulations over a range of plasma conditions to identify when and how such emergent behavior may take place.

Scientific Approach and Accomplishments

In laser-driven fusion experiments, stimulated Raman scattering (SRS) occurs when electron density fluctuations are amplified resonantly by the incident laser beams and scattered light. These laser beams comprise several thousands of individual laser speckles. We have found in our prior single-speckle studies that electron trapping, which occurs for electrons whose speed matches the phase speed of the plasma waves, lowers the threshold intensity for SRS onset to a value below that from linear theory and enhances scattering. Trapping of electrons induces a frequency shift in the plasma waves and leads to electron plasma wave-front bending and break-up (“filamentation”), processes that together saturate SRS and limit scattering within a speckle. These processes also produce hot electrons and side-scattered light waves. The former reduces wave damping, whereas the latter seeds new SRS growth. Both lead to the growth of SRS in nearby, lower-intensity speckles.

In this project, we employed the VPIC particle-in-cell (PIC) code to perform simulations of SRS in order to study how laser speckles interact through this exchange of particles and waves. We implemented new simulation diagnostics to elucidate and understand the nature of the coupling among speckles. We have developed new algorithms and implemented new boundary conditions for laser injection to enable simulations of SRS in yet larger networks of speckles.

With two- and three-dimensional simulations at modest size and large size, we examined how laser speckles interact with one another. Our work showed that kinetic trapping physics also governs the onset and saturation of SRS in small and large collections of speckles. Speckles interact in a way that is fundamentally nonlinear and nonlocal: As shown in Figure 1, an intense speckle can indeed destabilize its neighbors through transport of hot electrons and SRS, resulting in enhanced emission of particles and waves that, in turn, act upon the original speckle. In this way, speckles below threshold when in isolation can, in fact, be above the threshold in multi-speckled beams of sufficient size. Large-enough collections of speckles can collectively and cooperatively lower their SRS onset thresholds (Figure 2).

The nonlinear physics governing the kinetic behavior of SRS in large networks of speckles has been identified in the trapping regime at $k\lambda_D \sim 0.3$ (here k is the wave number of the electron plasma waves and λ_D is the Debye length) in homogeneous and inhomogeneous plasmas. Hot electrons from intense speckles, both forward and side-loss hot electrons produced during SRS daughter electron plasma wave bending and filamentation, seed and enhance the growth

of SRS in neighboring speckles by reducing wave damping. Trapping-enhanced speckle interaction through the transport of hot electrons, backscatter, and sidescatter SRS light waves enable the system of speckles to self-organize and exhibit coherent, sub-ps SRS bursts with instantaneous reflectivity exceeding 100% (Figure 3). This results in an SRS transverse coherence width (the transverse size of a region exhibiting a burst of SRS activity) that is much larger than a speckle width (Figure 4) and a SRS spectrum that peaks outside the incident laser cone. Such “avalanches” as seen in our simulations are common features of systems exhibiting self-organization.

We have shown that much of the nonlinear SRS physics in 3D is represented fairly in 2D, but that 3D speckles possess weaker inter-speckle coupling. Nevertheless, we have also shown that speckle interaction through exchange of hot electrons and SRS waves remains effective in 3D (Figure 5), enabling the potential for the same type of emergent, multi-speckle behavior observed in 2D multi-speckle simulations of SRS.

Impact on National Missions

Our project involved high-risk/high-payoff scientific R&D that underpins inertial confinement fusion experiments to achieve ignition and allowing for the fielding of meaningful high energy density physics experiments. The DOE/SC Office of Fusion Energy has an ongoing interest in inertial fusion energy in a variety of IFE approaches, including indirectly driven (i.e., hohlraum driven) capsules, direct driven capsules, shock ignition, and laser-driven fast ignition; our work also supports the primary mission of enabling nuclear power production from fusion.

Ignition experiments on the NIF have been identified as vital for the Stockpile Stewardship Program and other defense programs missions; recent strategic planning for the use of ICF for NNSA programmatic missions explicitly called out control of laser plasma interaction (LPI) as a primary research area. Therefore, this work is relevant to “Nuclear Weapons: Safety, Security, and Reliability of the Nuclear Stockpile” under “Mission Relevance,” one of the LDRD thrust areas

High energy density physics (HEDP) remains a priority of the Laboratory and greater DOE complex that is closely aligned with its nuclear security and energy independence goals; this work underpins the use of leading HEDP experimental facilities. A natural customer for this work would be the Science Campaigns, specifically Campaigns 1, 4 and 10, where laser-driven HEDP experiments are fielded.

LANL is likely to play a leading role in any prospective national inertial fusion energy program. LPI is a natural

problem area and test bed for improvements to our VPIC codebase, which is being further adapted for supercomputers such as the Trinity machine that are on the path to Exascale.

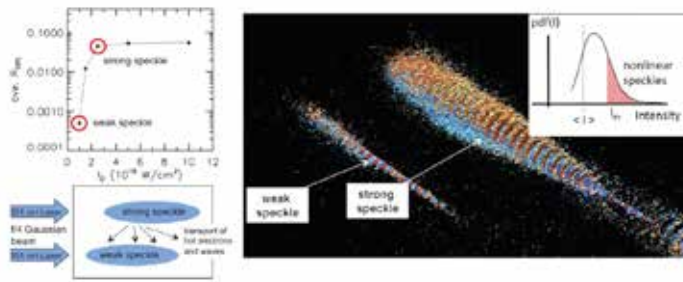

Figure 1. Upper left: SRS reflectivity vs. laser peak intensity scaling for an isolated speckle showing a sharp onset of nonlinear SRS at a threshold laser intensity and saturation at higher intensity. Lower left: Illustration of the simulation which includes a nonlinear, strong speckle above threshold intensity and a neighboring weak speckle below threshold intensity. Right panel: 3D simulation of two-speckle interaction shows that high intensity speckle can cause nonlinear SRS onset in a nearby speckle, whose intensity is below onset threshold if isolated. Shown are iso-surfaces of electrostatic field of the electron plasma waves with color indicating light wave field. Inset: illustration of the nonlinear speckles above the threshold intensity I populating the tail of the intensity distribution in an ensemble of speckles.

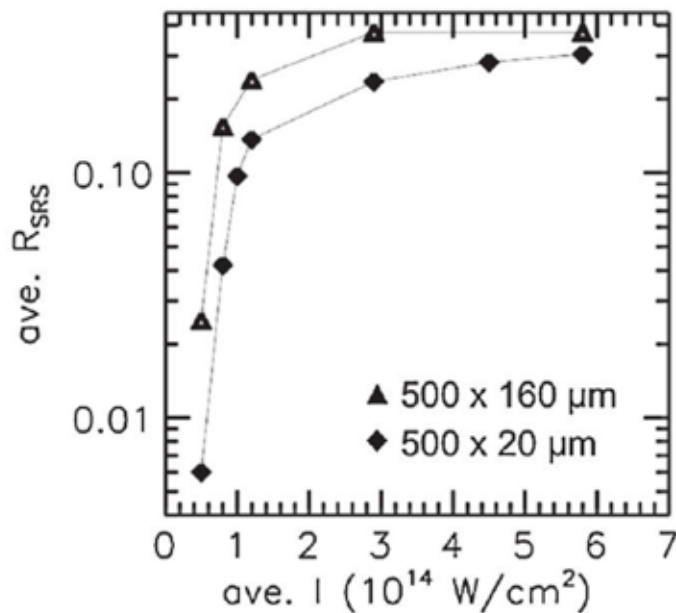

Figure 2. Time averaged SRS reflectivity vs. laser average intensity scaling for collections of speckles in domains 500microns by 20microns (black diamonds) and 500microns by 160microns (black triangles). Both systems show a sharp onset of SRS at a threshold laser intensity and saturation at higher intensity as found in isolated speckles. Although the system length is the same in the two sets of simulations, the wider system allows for more speckles to interact transversely. We found that in the

larger volume, the SRS onset threshold intensity is lower and that the time-averaged reflectivity is higher.

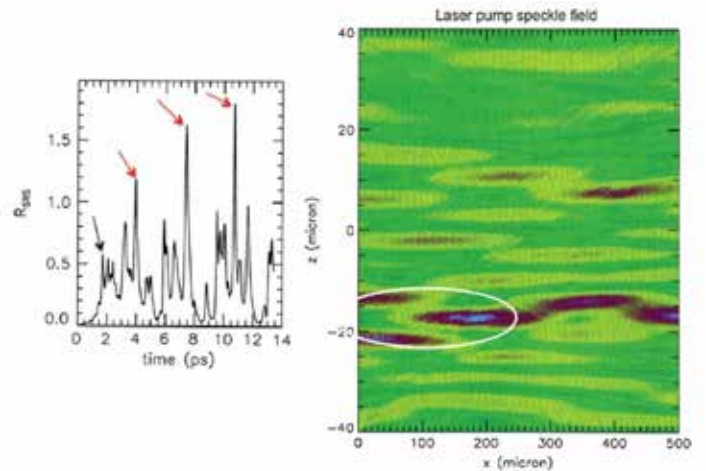

Figure 3. Left frame: SRS reflectivity, showing sub-ps bursts from a multi-speckled simulation. Right frame: The pump laser field. The black arrow indicates the first SRS burst from strong speckles in the white oval; large bursts are indicated by the red arrows. In a multi-speckled laser beam, the ensemble of uncorrelated laser speckles interact non-locally and exhibit a transition to self-organized, collective behavior. A manifestation of this is the presence of intermittent, large bursts of SRS with reflectivity > 1 , as indicated by the red arrows.

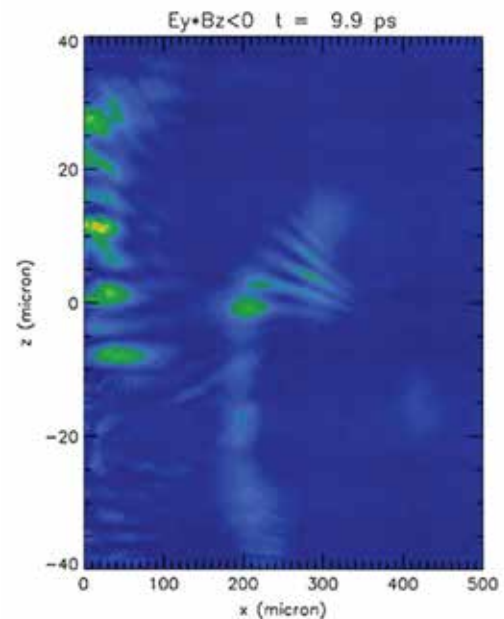

Figure 4. A snapshot of the backscatter flux of SRS, showing spatial locations of SRS bursts. In the simulation, strong speckles exhibit nonlinear SRS first. Hot electrons produced from the strong speckles can travel to the neighboring speckles and reduce wave damping; the scattered light waves can also seed new SRS in neighboring speckles. The speckle interaction creates a SRS “avalanche” throughout the network of speckles with a transverse scattered-light coherence width far greater than that of an individual speckle.

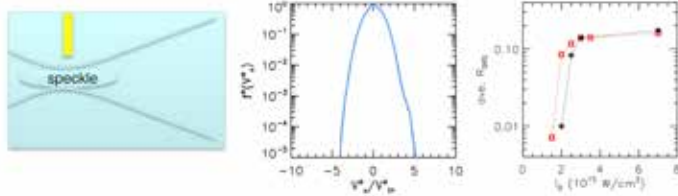

Figure 5. Right: SRS reflectivity scaling vs. single-speckle laser peak intensity using initial Maxwellian electron distribution (data in black) and SRS reflectivity (red) using a non-Maxwellian electron distribution with small, SRS induced hot-electron tail, shown in the middle frame, collected at the side of a speckle at peak as illustrated by yellow block in the left frame. The small hot electron tail is to mimic the hot electron effects in 3D. We found that indeed the onset threshold intensity is lowered when a small hot electron tail is used instead of Maxwellian.

References

1. Yin, L., B. J. Albright, H. A. Rose, K. J. Bowers, B. Bergen, and R. K. Kirkwood. Self-organized bursts of coherent stimulated Raman scattering and hot electron transport in speckled laser plasma media. 2012. PHYSICAL REVIEW LETTERS. 108: 245004.
2. Yin, L., B. J. Albright, H. A. Rose, K. J. Bowers, B. Bergen, R. K. Kirkwood, D. E. Hinkel, A. B. Langdon, P. Michel, D. S. Montgomery, and J. L. Kline. Trapping induced nonlinear behavior of backward stimulated Raman scattering in multi-speckled laser beams. 2012. PHYSICS OF PLASMAS. 19: 056304.
3. Yin, L., B. J. Albright, H. A. Rose, D. S. Montgomery, J. L. Kline, R. K. Kirkwood, P. Michel, K. J. Bowers, and B. Bergen. Self-organized coherent bursts of stimulated Raman scattering and speckle interaction in multi-speckled laser beams. 2013. PHYSICS OF PLASMAS. 20: 012702.
4. Albright, B. J., L. Yin, and B. Afeyan. Control of stimulated Raman scattering in the strongly nonlinear and kinetic regime using spike trains of uneven duration and delay. 2014. PHYSICAL REVIEW LETTERS. 113: 045002.
5. Yin, L., B. J. Albright, H. A. Rose, D. S. Montgomery, J. L. Kline, R. K. Kirkwood, J. Milovich, S. M. Finnegan, B. Bergen, and K. J. Bowers. Stimulated scattering in laser driven fusion and high energy density physics experiments. To appear in PHYSICS OF PLASMAS.
6. Yin, L., B. J. Albright, H. A. Rose, K. J. Bowers, B. Bergen, and R. K. Kirkwood. Selforganized bursts of coherent stimulated Raman scattering and hot electron transport in speckled laser plasma media. 2012. Physical Review Letters. 108: 245004.
7. Yin, L., B. J. Albright, H. A. Rose, K. J. Bowers, B. Bergen, R. K. Kirkwood, D. E. Hinkel, A. B. Langdon, P. Michel, D. S. Montgomery, and J. L. Kline. Trapping induced nonlinear behavior of backward stimulated Raman scattering in multispeckled laser beams. 2012. Physics of Plasmas. 19: 056304.
8. Yin, L., B. J. Albright, H. A. Rose, D. S. Montgomery, J. L. Kline, P. K. Kirkwood, S. M. Finnegan, B. Bergen, and K. J. Bowers. Stimulated scattering in laser driven fusion and high energy density physics experiments. To appear in PHYSICS OF PLASMAS.
9. Yin, L., B. J. Albright, H. A. Rose, D. S. Montgomery, J. L. Kline, R. K. Kirkwood, P. Michel, K. J. Bowers, and B. Bergen. Self-organized coherent bursts of stimulated Raman scattering and speckle interaction in multi-speckled laser beams. 2013. PHYSICS OF PLASMAS. 20 (1): -.

Publications

- Albright, B. J., L. Yin, and B. Afeyan. Control of stimulated Raman scattering in the strongly nonlinear and kinetic regime using spike trains of uneven duration and delay. 2014. PHYSICAL REVIEW LETTERS. 113: 045002.

Laser-Driven Relativistic Mechanics, Radiation, and Ion Acceleration

James A. Cobble
20120259ER

Abstract

The dominant physical effect of laser light exceeding 1020-W/cm^2 irradiance on a thin target is the generation of a many-mega-amp relativistic electron jet. The jet is pushed through the target by radiation pressure, and the departure of the jet from the target vicinity results in the erection of a multi-kV/atomic diameter, quasi-static electric field at the target's rear surface. As a direct consequence of the jet's existence, copious high-energy x rays and accelerated ions are produced: x rays ≥ 5 MeV and ion energies of >50 MeV. Previously, with no direct measurement of jet behavior, the physics was known only in generalities. The proposed goal was to diagnose the jet – to see what became of electrons behind the target. Phase contrast imaging (PCI) was proposed to image jet geometry. With a sub-ps probe, we hoped to resolve temporally and spatially the jet length, width, duration, and stability in 2D for many ps after the laser shot. Charge collection permitted us to measure jet charge and charge density. Coupled with electron divergence measurements, we could estimate total charge leaving the target and the total current. The emerging discoveries of this research have indeed 'plowed new ground' for understanding the physical effects.

Background and Research Objectives

Radiation driven by PW-class lasers may be crucial for diverse problems from fusion energy production (fast ignition) to health care to weapons physics and material science. To apply this radiation usefully, we must understand the energetic electron and ion properties resulting from PW-laser interactions to determine the radiation scaling. Although many experiments have been performed to understand electron behavior, conclusive results have been rare. There remained a real need to directly measure the characteristics of the 'electron debris' that appears behind the target, creates the intense radiation, and to validate models to be used for scaling studies.

Scientific Approach and Accomplishments

As indicated above, the objectives of the research were to assess the electron jet stability, divergence, charge density (current), and general behavior. The basic diagnostics included PCI, mapping of the electron trajectories (divergence), and charge collection with a Faraday cup. Several first-in-the-world measurements were achieved.

Figure 1 shows a sketch of the laser PCI apparatus. The short-pulse beam driving the electron beam enters the thin-film target from above in the sketch. The $\sim 600\text{-fs}$, 527-nm probe beam enters from the left, parallel to the plane of the target. The probe propagates nominally as a plane wave and interacts with the electrons that suppress the refractive index in the interaction volume. The perturbed wave front is imaged by lenses downstream where PCI theory may be used to deduce the integrated line charge density of the electron populations in the field of view.

Data were taken of this optically thin domain with ~ 0.6 ps temporal resolution over the interval $\sim 2 - 70$ ps following the arrival of the jet-forming beam on target. The field of view of this diagnostic was $\sim 1\text{ mm}^2$. Two phenomena were photographed: a series of concentric, irregularly-space rings, centered roughly at the target position late in time and a slow jet of electrons which appears to be moving in conjunction with the accelerated ion beam ejected from the target by the strong electric field associated with departure of the relativistic electrons. This is illustrated in Figure 2.

So late in time (~ 18 ps), the relativistic electrons are > 5 mm down range by the time this exposure was made. The obvious rings are not moving radially at relativistic speed else they would exhibit motional blur – their velocity times the duration time of the probe. This is not the case. This ring-like structure is seen to persist for 70 ps in other exposures. It is not known what causes this structure. One guess is that it is the residual effect

of electron vortices formed during the laser pulse, but particle-in-cell codes are hard pressed to run through even the end of the laser pulse – not for tens of ps.

The second feature is associated with ions. Because of their large mass, ions do not alter the refractive index, but the horizontal feature may be due to thermal electrons in the vicinity of the accelerated ion beam (from a carbon target). The electrons may be drug along by an ion charge approaching 1 μC . Their azimuthal spread is not relativistic for the same reason mentioned above. They are not spread sufficiently to indicate a motional blur. Furthermore, their divergence is very nearly the 10 σ half-angle spread of accelerated ions reported in the scientific literature. If this model is correct, the C ions traveling with these electrons have moved > 400 μm in 18 ps, which corresponds to C atoms having an energy of ~ 30 MeV. Just to remind the reader, C ion beams in the 100s of MeV class, if controlled, have the potential to destroy cancers in inoperable locations in the body with minimal damage to surrounding tissue.

While the early time history of relativistic electrons is not so clear, we have measured the electron divergence. The electrons emanating from the target pass into a wedge-shaped magnetic field through a narrow slit perpendicular to the page and parallel to the field direction. “Wedged” means the pole pieces are not parallel but are wedged apart at the rear, like the letter “V” looking down from above. The electrons are dispersed by energy in the field since the electron cyclotron radius increases with electron energy so that the most relativistic ones are scarcely deflected by the field compared to their less energetic companions. The field, a few hundred Gauss, is variable front to back because of the wedge. Regardless of the electron energy (height above the axis at the detector), to 0th order all electrons passing through the slit have about the same divergence. A schematic drawing of the apparatus is seen in Figure 3.

Electrons are deflected upward, impacting the image plate after they have drifted beyond the field region. Ions are deflected downward in the field. Photons propagating through the slit impact the IP “on axis”. The sensitivity of the IP is greater for electrons than for photons, however; so, the 0th order was seldom seen in the data. An example of the electron divergence is seen in Figure 4. The full-scale angular spread captured on the IP is $\sim \pm 15\sigma$. As discussed above, for the various horizontal bands of electrons (the virtual constant-energy contour lines), the divergence is energy independent – has approximately the same value $\sim 10\sigma$ half angle for all energies. The apparent bright feature at 0 cm along the horizontal axis is a population of very collimated electrons that represent a

bump-on-the-tail on the energy distribution, which was also measured in several electron spectrometer measurements – a perturbation on the usual exponential energy distribution, typically showing up between 15 and 30 MeV. It represents a small portion of the total electron flux. The shark fin appeared and disappeared from shot to shot, and it is a curious feature, perhaps related to whether the thin target becomes relativistically transparent to the laser light as the electrons put on mass in response to their acceleration; $m \rightarrow \gamma m_0$ where m_0 is the electron rest mass, the Lorentz gamma factor and $v \rightarrow c$. Said another way, with depletion of the electron density in the thin Al target and a ~ 100 fold increase in γ , the laser frequency at some point instantaneously exceeds the target plasma frequency. The result is laser light penetrating a solid-density Al matrix in the target and shining through to diagnostics on the back side. Regardless, electron energies determined with magnetic electron spectrometers showed peak values up to 70 MeV. This distribution function $f(E)$ drives the ion acceleration and all the rest. Understanding $f(E)$ and how it scales with laser power is the key to practical applications.

The final topic is charge measurement. Previous experiments by others to measure the conversion efficiency of short-pulse laser light to electron energy range from 20% to 60%. This is not an especially satisfying conclusion. We attempted to measure the charge density with a Faraday cup – no mean feat in the face of 2-keV peak-to-peak noise on the signal cable. We paid careful attention to noise suppression: triax cable, elimination of ground loops, and an uninterruptable power source for the recording oscilloscope and grid bias. The grid was deployed to push secondary electrons back toward the collection cup – the opposite of what one does, for example, with an x-ray diode. The results were remarkable, as seen in Figure 5a. The noisy trace is typical of “pick up” for a 180-TW laser shot on target at the Trident laser. The thin red line on axis is the output for the Faraday cup when it is behind a Pb brick, i.e., is not expected to collect electrons. It shows we solved the noise problem. Figure 5b shows a successful measurement of collected charge: both the raw signal and another with additional processing by a low-pass mathematical filter. This shows that the simple technology works. An array of Faraday cups could unequivocally measure electron divergence. This is desirable since the IP data have a high background noise too.

The Faraday cup provided a point measurement of the charge density at a particular value of the angle θ off the laser axis. Using the divergence data, we modeled the total integrated charge as a Gaussian distribution in θ with the result that 5 – 15 μC of charge are ejected from the target at a distance > 0.75 m from the target. Unfortunately,

temporal resolution is lacking with the cup data. As a most optimistic case, one might assume that the electrons, all relativistic, arrive at the cup within a time period about equal to the duration of the laser. This results in a current estimate of ~ 10 MA. The average electron energy from the spectrometer suggests the idea that a very large fraction of the laser energy is carried by relativistic electrons – perhaps exceeding 50% for the thin targets.

The Figure 2 image was filtered by Fourier techniques to remove noise – Fresnel fringes from the edge of the target holder. What is lacking is solving the non-homogeneous Laplacian equation for discovering contours of constant line-integrated electron charge density that depend on the PCI image. Then one could in principle answer the question of the charge neutrality of the accelerated multi-MeV ion beam. Further analysis of the images was a victim of the first Congressional budget passed in six years. When LDRD funding was reduced early this year, the FY2014 allotment for this project was reduced by more than a factor of two. The problem was not with the quality of work. Other casualties of the cuts were the Faraday-cup array for unequivocally determining the divergence and the publishing of science papers on these topics.

Impact on National Missions

Several first-in-the-world measurements were achieved: first measurement of electron divergence behind a high-intensity short-pulse laser target, first measurement of charge density with a Faraday cup (or any other device), first estimate of integrated charge emitted from the target, first data-based estimate of emitted electron current, first optical evidence of the accelerated ion beam (rather, the electrons accompanying it), and first detection of the unusual ring-like structure via PCI behind the target for tens of picoseconds.

The inherent relativistic electron jet dominates radiation processes for electrons, ions, and x rays in ps-laser interactions. Once jet manipulation is understood and scaling laws are determined, managers have a decision point for capability building. We will know: 1) how big and what quality of laser is necessary to pump electron (or ion) fast ignition at the National Ignition Facility, 2) what is required to accelerate ions to greater than 1-GeV energy for cancer or other uses, whether for medical or national security purposes, 3) the feasibility of focusing other energetic ions, and 4) what laser to build for MaRIE for shock physics and materials research utilizing 20 – 100-keV x rays. Successful development of high-energy backlighters opens doors, for example, the possibility of phase-contrast imaging with x ray.

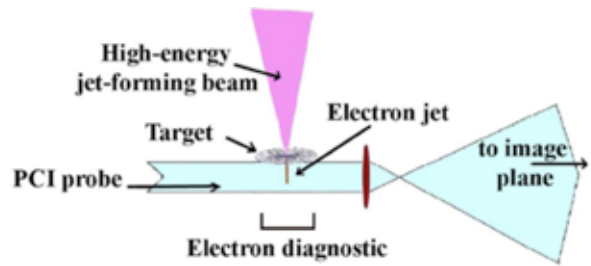

Figure 1. Schematic drawing of the PCI set up – imaging optics not shown

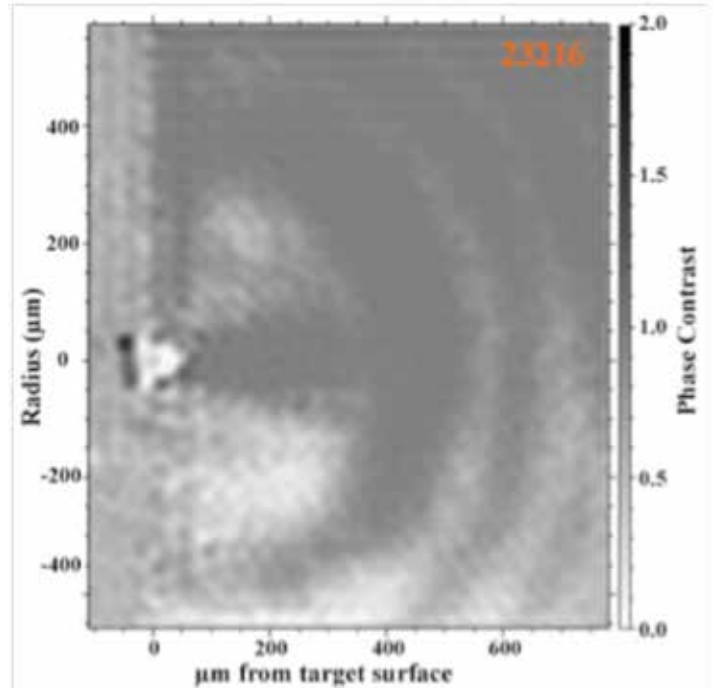

Figure 2. Trident Laser PCI data showing circular electron structures and features indicative of ion acceleration at $t = 18$ ps

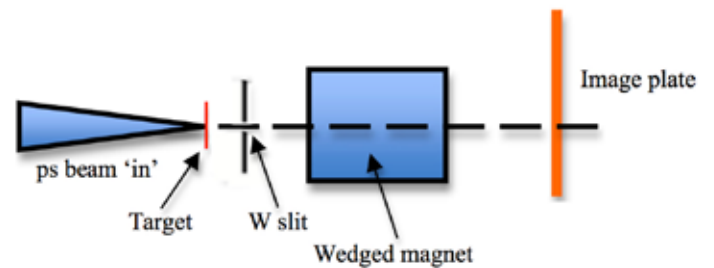

Figure 3. Sketch of wedged-magnet technique to measure electron divergence

Publications

Cobble, J. A.. Trident shot 23858 –electron and proton energies & Dexter calibration. 2013. P-24:2013-038, LA-UR-13-26309.

Cobble, J. A.. Proton converter for GCD on Trident. 2013. P-24:2013-022.

Cobble, J. A.. SUBJECT: Divergence of E beam in 100-TW Trident Experiments. 2013. P-24:2013-070, LA_UR-13:27148.

Cobble, J. A., S. Palaniyappan, D. C. Gautier, Y. H. Kim, D. D. Clark, R. P. Johnson, T. Shimada, J. C. Fernandez, and H. W. Herrmann. Relativistic transparency experiments at the Trident Laser. 2013. In 55th Annual Meeting of the APS Division of Plasma Physics. (Denver, Colorado, 11-15 November 2013). Vol. 58, No. 16 Edition, p. PO6.00009. Bulletin of the American Physical Society: American Physical Society.

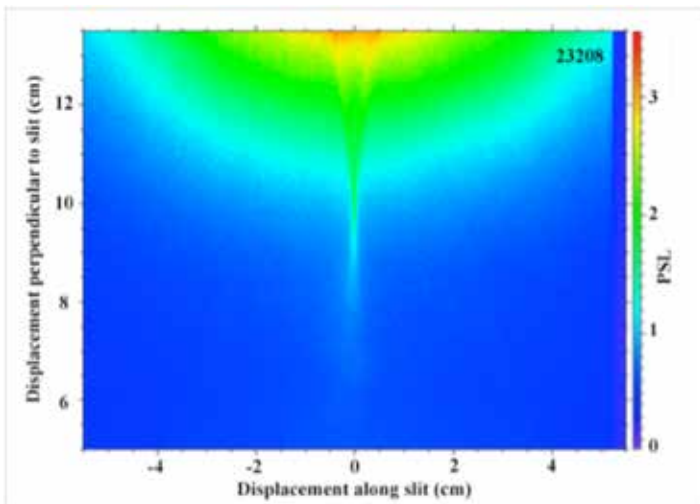

Figure 4. Image plate capture of electron divergence

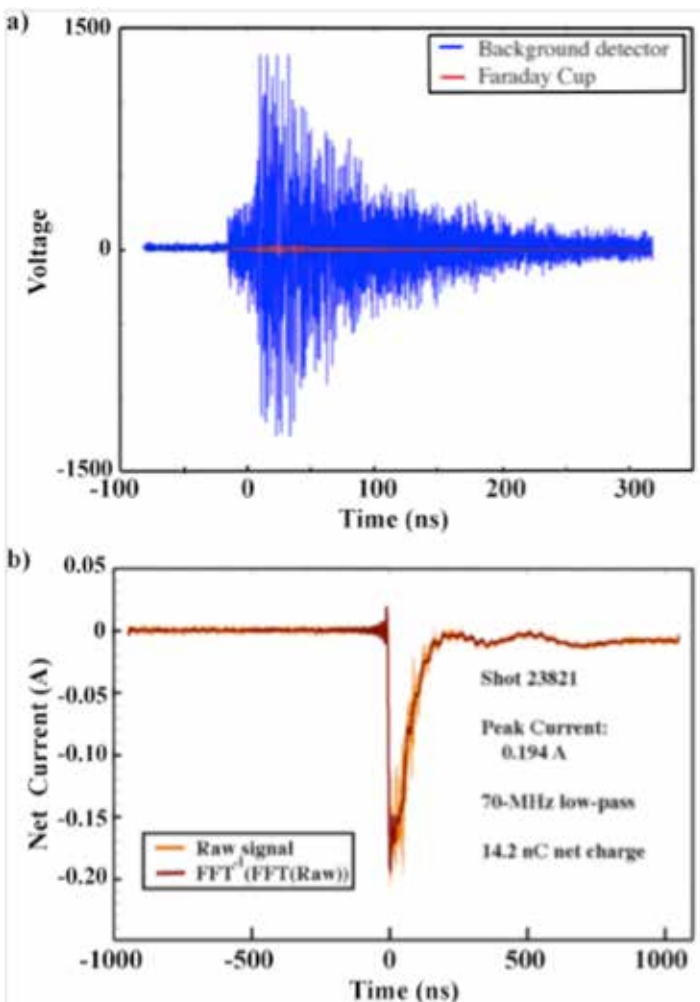

Figure 5. Typical kV-noise pick up at Trident vs. the shielded Faraday cup; b) A raw Faraday-cup signal and the signal treated with a low-pass filter to damp residual noise – The cup was > 75 cm from the target.

Probing BSM Discoveries at the Large Hadron Collider

Michael L. Graesser
20120314ER

Abstract

The Standard Model is a description of the interactions between quarks, leptons and their force carriers. Experimentally it is highly successful, being firmly established through the precision measurements at low-energies, LEP, the Tevatron, and by the discovery of the top quark in the mid-1990s. The origin of mass – “electroweak symmetry breaking” – remains elusive however. An era of theoretical speculation spanning three decades on this fundamental problem has finally come to an end with the first physics run of the Large Hadron Collider (LHC). This experiment will soon probe a new frontier by directly exploring the interactions of matter at the TeV scale, and through its discoveries a new Standard Model will take shape. It is a high priority of the particle physics community to develop methods to elucidate the physical properties of the new particles discovered, such as their spin, quantum numbers and interactions with other particles, properties that are not directly probed by conventional methods. To construct the underlying theory at the TeV scale it is absolutely critical that these properties be unambiguously identified. We will develop specific strategies and illustrate their effectiveness in candidate theories such as supersymmetry and extra dimensions. We will incorporate into our analyses any new discoveries and measurements made in the first physics run of the LHC, by proposing subsequent measurements to further pin down the physical properties of the new discoveries and eliminate degeneracies between competing theories.

Background and Research Objectives

The Large Hadron Collider (LHC) has finished its first physics run. It discovered the Higgs boson and generated over 100 picobytes of data that is being used to constrain new theories of Nature at the TeV scale (that is, Beyond-the-Standard-Model physics (BSM)). The first run of the LHC experiment began to probe a new frontier by directly exploring the interactions of matter at the TeV scale, and through its discovery of the Higgs boson a

new Standard Model is beginning to take shape. During the next run slated to start in 2015, the LHC will collide protons together at 14 TeV of center-of-mass energy, nearly two times higher than its value for the first run. The LHC will directly explore the nature of physics at the TeV-scale.

In the Standard Model, the Higgs boson gives mass to all of the elementary particles, such as the electron, top quark and W boson. The discovery of the Higgs boson in 2012 [1,2] appeared to put the missing capping stone of the Standard Model firmly into place. Instead, this discovery has brought the question of the “origin of mass” sharply into focus. Faced with the existential reality of the Higgs boson, nagging questions about the internal consistency of the Higgs boson itself have now been brought to the forefront; even the consistency of these “nagging questions” have been questioned.

The questions raised by the existence of the Higgs boson will only be truly settled with the discovery of additional new particles. It is therefore a high priority of the high-energy particle physics community to discover new particles. That process is facilitated by improving the sensitivity of the LHC experiment to new particles, through developing new methods to elucidate the new physics probed by this experiment, and using current and forthcoming LHC data to constrain BSM physics.

This ER project has identified third generation particles of the Standard Model – tau leptons, tau neutrinos, and the bottom and top quarks – as useful probes to address these physics goals in a way that is fairly independent of the specific theory realized at this scale. These particles can be used as experimental handles to infer important physical properties of the new particles produced. These include their spin, quantum numbers, and interactions with other particles, properties that are not directly probed by conventional methods. Moreover, these particles can also be used to improve the sensitivity of the

LHC experiment to new particles.

To construct the underlying theory at the TeV scale it is absolutely critical that, first, new particles be discovered, and next, that their physical properties be unambiguously measured. During the course of this project we have developed specific strategies to enhance the discovery potential of the LHC to discover new particles [3]. We focused on supersymmetric models for BSM physics that produce top and bottom quarks in the final state. We proposed a new final state for the LHC collaborations to investigate in order to improve their sensitivity to new BSM particles that couple to the top quark. We also introduced a new kinematic variable – which we dubbed “topness” – that could be used to significantly increase the LHC experiments’ sensitivity.

Our ideas and topness variables are now incorporated into the ATLAS experiment’s search for hypothetical top squark particles [4]. It is anticipated that both ATLAS and CMS LHC experiments will use our work to enhance their search analyses in the next run of the LHC beginning in 2015.

Neutrinos have very weak interactions with the Standard Model, yet are the only fundamental particles in which BSM physics has been discovered. Neutrinos may therefore be the place where other BSM particle physics will be discovered first. New physics in neutrinos may occur in so-called “non—standard neutrino interactions” (NSI), which were first proposed by L. Wolfenstein in his landmark paper on neutrino oscillations. In non-standard neutrino interactions, neutrinos interact with quarks just as they do in the Standard Model, except that the size of the interaction is different.

The LHC experiment collides protons together; since protons are comprised of gluons and quarks, the LHC is really colliding quarks and gluons. The presence of non-standard neutrino interactions implies that the production of neutrinos from collisions of quarks is modified. We were able to use data from the LHC to constrain certain kinds of non-standard neutrino interactions (especially those involving tau-neutrinos) [5]. For some of these interactions, our constraints provide the world’s best bounds. This work has implications for searches for non-standard neutrino interactions at the future Office of Science HEP flagship experiment, the Long Baseline Neutrino experiment (LBNE).

We further note that the papers published during the course of this ER project are well-cited and in particular, being cited by the ATLAS and CMS experiments.

Scientific Approach and Accomplishments

A major focus of searches for BSM physics at the LHC is on

finding supersymmetry. Theoretical interest in supersymmetry arise from several of its features, including stabilizing the interactions of the Higgs boson, and providing a dark matter candidate. The superparticle with the largest coupling to the Higgs boson is the superpartner of the top quark, the so-called top squark. Searching for top squarks at the LHC is therefore a top priority.

Even if supersymmetry does not exist at the TeV scale, general theoretical arguments suggest there should be a new particle coupled strongly to the Higgs boson in order to stabilize its interactions (for an exception to this statement, see the so-called “Twin Higgs” theories [6]). These general considerations motivate searching for a new particle that is strongly coupled to the Higgs boson and is charged under the strong interactions of the Standard Model. While the top squark of supersymmetry is a particle having these properties, other examples outside of supersymmetry exist.

To search for new physics, the general strategy used at the LHC is to classify events according to what the detectors see, specifically the types of particles it detects, which we call a signature. An example would be a final state containing one lepton, two bottom quarks and an imbalance of momentum transverse to the direction of the colliding beams. The latter quantity is referred as missing transverse energy (MET). Since the transverse momentum is conserved in a proton-proton collision at the LHC, the observation of a non-zero value of MET in the event, not attributable to mis-measurements of momentum and energy, indicates the presence of a particle that has escaped invisibly from out of the detector. In Standard Model processes these are neutrinos. For a given BSM model, one then maps its processes onto experimental signatures, and compares to the LHC data measured for that signature, as well as predictions of the Standard Model for that signature.

Top squarks are charged under the strong interactions of the Standard Model, and therefore have large production rates. How they decay depends on the specific BSM realization, but typically they decay to top quarks. In [3] M. Graesser and external collaborator J. Shelton realized that for a wide class of supersymmetric models, a pair of top squarks can decay to a top quark, a bottom quark, and invisibly escaping particles producing MET, with a sizable branching fraction. At the time we published our work, the ATLAS and CMS experiments were not searching for top squarks in this signature, and as a result, had reduced sensitivity to top squark production. The dominant background to this process occurs from the production of top quarks through Standard Model processes. Further, in [3], we invented a new kinematic variable that we called “topness.” This variable discriminates between the domi-

nant top quark background and the top squark signal. We showed that our variable is an effective suppressant of the Standard Model top quark background and improves the significance of the top squark signal significantly. We further demonstrated that our topness variable outperforms all existing variables, in both the new signature we were proposing (tb+MET final state), and the standard (tt+MET) signature that the collaborations had been using to search for top squarks.

Ref. [3] by M. Graesser and J. Shelton was published in the prestigious Physical Review Letters journal.

In [4] the ATLAS collaboration used our topness variable in two of their analyses searching for top squarks – in the tb+MET final state, as well as the tt+MET final state. We expect that the ATLAS collaboration will continue to use our work to analyze the data they will collect in the forthcoming run of the LHC. We have also been in contact with members of the CMS collaboration and it appears that they will also use our work to analyze the LHC data produced in the next run.

With LANL post-docs I. Shoemaker and L. Vecchi, in Ref. [5] A. Friedland and M. Graesser explored the potential for the LHC to constrain non-standard neutrino interactions between neutrinos and quarks. The collision of two quarks through an NSI interaction leads to final states containing a jet and MET caused by the escaping neutrinos. We used LHC “mono-jet” data to place bounds on the strength of the NSI signal, under two scenarios for modeling the NSI. In the “contact” limit of a mediator mass heavier than the typical collision energy of the quarks ($O(\text{TeV})$), our limits for interactions involving tau neutrinos are the best in the world. As the mediator mass is lowered, the constraint on such interactions strengthen dramatically. As the mediator mass is decreased further, below the size of the typical cuts used in the analyzes ($O(100 \text{ GeV})$), the limits weaken significantly. We explained this feature as arising from weaker acceptances that occur as the mediator mass becomes smaller. This occurs because for a light mediator, the spectrum of the monojet decreases, unlike the spectrum in the contact limit, which rises as the transverse momentum of the monojet is increased. Consequently, for fixed cuts, the acceptance decreases as the mediator mass is lowered. This means that for light mediators, experiments done at lower energy (such as the Tevatron) set better limits in this regime.

Ref. [5] by M. Graesser and collaborators was published in the highly regarded Physics Letters B journal.

Our work has implications for the interpretation of a possible anomaly seen in the Boron-8 Sudbury Neutrino

Oscillation experiment data [7]. If the anomaly is being caused by non-standard neutrino interactions, then our work shows that the LHC monojet data constrains such an interpretation, and may completely exclude it if the mass of the mediator is of $O(100\text{'s GeV})$.

Impact on National Missions

This project supports the Laboratory Mission to enhance the nation’s scientific capabilities, as defined by the DOE Office of Science. Within the Los Alamos National Laboratory, this project is aligned with Nuclear and Particle Physics Pillar. This project contributes to the search for BSM physics at the LHC, which is a top priority in the DOE’s HEP energy frontier, as endorsed by the Particle Physics Prioritization Panel in 2008 and again in 2014 (the so-called “P5 reports”). By building expertise in theoretical particle physics, this ER will maintain and enhance LANL’s capability in this area.

References

1. ATLAS Collaboration, “Observation of a new particle in the search for the Standard Model Higgs boson with the ATLAS detector at the LHC”. 2012. Physics Letters B. 716: 1.
2. CMS Collaboration, “Observation of a new boson at a mass of 125 GeV with the CMS experiment at the LHC”. 2012. Physics Letters B. 716: 30.
3. Graesser, M., and J. Shelton. Hunting Mixed Top Squark Decays . 2013. Physical Review Letters. 111: 121802.
4. ATLAS Collaboration, “Search for top squark pair production in final states with one isolated lepton, jets, and missing transverse momentum in $\sqrt{s}= 8 \text{ TeV}$ pp collisions with the ATLAS detector”. arxiv:1407.0583.
5. Friedland, A., M. Graesser, I. Shoemaker, and L. Vecchi. Probing Nonstandard Standard Model Backgrounds with LHC Monojets. 2012. Physics Letters B. 714: 267.
6. Chacko, Z., and H. S. Goh. The Twin Higgs: Natural Electroweak Breaking from Mirror Symmetry . 2006. Physical Review Letters . 96: 231802.
7. SNO Collaboration, “Combined Analysis of all Three Phases of Solar Neutrino Data from the Sudbury Neutrino Observatory”. 2013. Physical Review C. 88: 025501.

Publications

Chen, M. C., J. Huang, J. M. O’Bryan, A. Wijangco, and F. Yu. Compatibility of θ_{13} and the Type I Seesaw Model with A4 Symmetry . 2013. Journal of High Energy Physics (JHEP) . 1302: 1.

-
- Chen, M. C., J. Huang, K. T. Mahanthappa, and A. Wijangco . Large θ_{13} in a SUSY SU(5) x T' Model. 2013. Journal of High Energy Physics (JHEP) . 1310: 1.
- Friedland, A., M. Graesser, I. Shoemaker, and L. Vecchi. Probing Nonstandard Standard Model Backgrounds with LHC Monojets. 2012. Physics Letters B. 714: 267.
- Graesser, M. L., and J. Shelton. Hunting Mixed Top Squark Decays. 2013. PHYSICAL REVIEW LETTERS. 111 (12): -.
- Huang, J., T. Liu, L. T. Wang, and F. Yu. Supersymmetric Exotic Decays of the 125 GeV Higgs Boson . 2014. Physical Review Letters.
- Huang, J., T. Liu, L. T. Wang, and F. Yu. Supersymmetric Sub-Electroweak scale Dark Matter, the Galactic Center Gamma-ray Excess, and Exotic decays of the 125 GeV Higgs boson. arxiv.
- Huang, J., and A. Nelson . MeV dark matter in the 3+1+1 model . 2013. Physical Review D (PRD) . 88 (033016): 1.
- Keren-Zur, B., P. Lodone, M. Nardecchia, D. Pappadopulo, R. Rattazzi, and L. Vecchi. On Partial Compositeness and the CP asymmetry in charm decays. 2013. Nuclear Physics B. 867: 429.
- Shoemaker, I., and L. Vecchi. Unitarity and Monojet Bounds on Models for DAMA, CoGent and CRESST-II. 2012. Physical Review D. 86: 015023.
- Vecchi, L.. A Flavor Sector for the Composite Higgs. 2012. ArXiv.org and INSPIRES Data base .

Nuclear and Particle Futures

Exploratory Research
Final Report

A Novel Exploration of Nature's Largest Explosions

W T. Vestrand
20120375ER

Abstract

We deployed and operated an integrated suite of autonomous robotic optical instruments to measure the properties of prompt optical flashes and optical afterglows generated by Gamma-Ray Burst (GRB) explosions. The novelty of our approach was to employ full-sky persistent monitors in conjunction with our fast slewing robotic telescopes to collect optical measurements in the minutes before the explosion, during the prompt gamma-ray emitting explosion interval, and during the onset and early phases of the post explosion afterglow. This approach was extremely successful and allowed the collection of optical observations for a powerful gamma-ray burst, GRB 130427a that, when combined with x-ray and gamma-ray measurements from NASA's Swift and Fermi missions, probed the physics of gamma-ray bursts with unprecedented temporal and spectral detail. Straightforward interpretation of our observations solved the puzzle of the origin of the very highest energy gamma-rays. Unlike the lower energy gamma-rays which are generated by colliding internal shocks in the relativistic outflow, we showed that the highest energy gamma-ray are emitted by relativistic electrons that are accelerated by interaction of the explosion ejecta with surrounding environment. Our successful observational effort was complemented by a comprehensive theory and modeling effort. Together, these efforts led to several new discoveries: (1) Reverse shocks play a key role in accelerating particles to the very highest energies; (2) Most GRB afterglows require sustained energy injection by a central engine; and (3) Both optical and x-ray afterglows reach a peak luminosity at a time that is anti-correlated with the time required to reach peak luminosity---a relationship that suggests we are often observing afterglow emission from a conical jet interacting with the stellar wind of the progenitor star.

Background and Research Objectives

The production of cataclysmic explosions by collapsing compact objects, the generation of relativistic jets, and

the acceleration of high energy particles are processes of fundamental importance in high energy astrophysics that are still not well understood. Gamma Ray Bursts (GRBs) are the sites where those processes are pushed to their most extreme forms: generating explosions that are the biggest since the Big Bang; ultra-relativistic jets with flow speeds of 99.9999% of the speed of light; and perhaps particles with the highest energies ever measured. This extreme nature of GRBs makes them ideal laboratories for exploring fundamental high energy processes and provides a powerful probe of conditions in the distant Universe that are difficult to explore any other way. Since their discovery with our Nuclear Test Ban monitoring instruments on the Vela Satellites, scientists at Los Alamos National Laboratory (LANL) have maintained a history of scientific leadership in the study of GRBs. Today, that LANL tradition is continuing with our network of RAPTOR (RAPid Telescopes for Optical Response) telescopes that constitute the world's most capable system for observing the optical light from GRBs before and during the critical first few minutes after the onset of these cataclysmic explosions.

Our approach to modeling the optical emission, in order to determine the fundamental properties of the jet and its' radiation process, relies on the synergy of the simultaneous multi-color optical measurements from RAPTOR, the gamma-ray data obtained by Swift-BAT and Fermi-GBM instruments, and the > 100 MeV measurements from Fermi-LAT. To isolate the prompt component, we measured the optical spectral energy distribution at times when the variable optical flux that tracks the burst emission is dominant over the smooth optical afterglow component. The multi-wavelength spectral energy distribution of the emission constructed with the measurements from these three instruments was used to indicate if the burst radiation process is synchrotron (if the optical and MeV measurements are consistent with single spectral component) or inverse-Compton (if the optical flux is brighter than the extrapolation of the burst

spectrum). The GeV flux provided a test of that identification by comparing it with the results of a simple and robust model for the prompt emission which we developed. That model relates the available observables—optical flux, optical spectral slope, burst peak flux, burst spectrum peak photon energy, GeV flux—to the following fundamental model parameters: source Lorentz factor, magnetic field strength, optical depth to electron scatterings, total number of radiating electrons, and typical electron Lorentz factor. Knowledge of these parameters that accommodate the gamma-ray and optical counterpart properties were used to identify the dissipation mechanism, as the plausible values of some of the five parameters above vary with that mechanism (e.g. a high optical-depth is encountered in Poynting outflows, while a low optical-depth exists in internal shocks occurring in a variable outflow).

In short, the novelty of our approach was in the use of persistent full-sky monitoring to measure the early optical flash in conjunction with fast follow-up simultaneous multi-color measurements (Figure 1) and model them with a comprehensive numerical model for the synchrotron and inverse-Compton emissions from relativistic outflows.

Scientific Approach and Accomplishments

Three of our full sky RAPTOR monitors in New Mexico and in Maui detected a bright optical flash (7th magnitude) and fading afterglow [1] from a powerful burst, GRB 130427A, that set new records for gamma-ray brightness and duration [1-2]. This flash, the second brightest ever detected, is the first to allow detailed comparison of the optical emission through the whole course of event with both the properties of the keV/MeV gamma-ray emission measured by Swift and the MeV/GeV high-energy gamma-ray emission measured by Fermi (Figure 2). We found the optical flash from GRB 130427A was delayed (Figure 3) with respect to the keV/MeV emission measured by the Swift BAT (Burst Alert Telescope)—which, employing the standard optical emission taxonomy [3], indicates that the optical flash is early afterglow emission like that measured in GRB 990123 [4]. Further, these flash observations when combined with subsequent observations taken with our narrow-field rapid response telescopes show a striking correlation between the optical light curve and >100 MeV photon flux light curve during the first 7,000 seconds.

This discovery of a link between the >100 MeV gamma-ray light-curve and the optical afterglow light-curve indicates co-generation in an external shock (Figure 4)—a result that was featured in the journal *Science* [1]. It also solves the puzzle of why the highest energy gamma-rays are often detected well after the lower energy gamma-rays have faded away—they are generated by a completely differ-

ent population of energy particles. Our joint modeling of the simultaneous, multi-color, RAPTOR observations with the Swift and Fermi x-ray/gamma-ray energy observations indicate that the broad emission is best explained at early times by reverse shock emission generated in the relativistic burst ejecta as it collides with surrounding material and at late times by a forward shock traversing the circumburst environment.

The theory and modeling component of our effort was also very successful. One of the highlights was our development of the new reverse shock model for generation of >100 MeV gamma-rays in GRBs [5]. By adding that new model component to the standard forward shock synchrotron picture, we were able not only to model and successfully fit the optical and GeV gamma-ray afterglows of GRB 130427A, but also simultaneously fit the radio afterglow (which was monitored to 10 days) and the x-ray afterglow (which was monitored out to 50 days). An interesting result of that study was that the high ratio of the early optical to late radio flux requires that the ambient medium is a wind and that the forward-shock synchrotron spectrum peaks in the optical at about 10 ks. The latter has two consequences: the wind must be very tenuous and the optical emission before 10 ks must arise from the reverse-shock, as suggested also by the bright optical flash we detected during the prompt emission phase (<100 s). We found that the radio emission is from the reverse-shock, the X-ray emission is mostly from the forward-shock, but the both shocks give comparable contributions to the Fermi GeV emission. The low density of stellar wind from stellar progenitor implies a large blast-wave radius and a very tenuous circumstellar medium. This led us to conclude that the massive stellar progenitor of GRB 130427A resided in a superbubble similar to the one that our Sun resides in.

We also investigated the effect that the absorption of high-energy (above 100 MeV) photons produced in gamma-ray burst afterglow shocks has on the light curves and spectra of Fermi Large Area Telescope (LAT) afterglows [6]. We found that afterglows produced by the interaction of a relativistic outflow with a wind-like medium peak when the blast wave deceleration sets in, and the afterglow spectrum can harden before that peak, as the optical thickness to pair formation is decreasing. In contrast, we found that for afterglows produced by interaction with a homogeneous medium, the optical thickness to pair formation increases and yields a light curve peak when it reaches unity, followed by rapid light curve decay, accompanied by spectral softening. But if energy is injected into the blast wave, then the accelerated increase of the optical thickness yields a convex afterglow light curve. We also found that other features, such as a double-peak light curve or

a broad hump, can arise from the evolution of the optical thickness to photon-photon absorption. Fast decays and convex light curves are seen in a few >100 MeV gamma-ray afterglows, but the expected spectral softening is rarely seen in (and difficult to measure with) Fermi LAT observations. Furthermore, for the effects of photon-photon attenuation to shape the high-energy afterglow light curve without attenuating it too much, the ejecta initial Lorentz factor must be in a relatively narrow range (50-200), which reduces the chance of observing those effects.

Another highlight of our program was the answering of a key open scientific question: How long does the Gamma-Ray Burst (GRB) central engine inject energy into the ultra-relativistic outflow? To explore that question the team examined the optical and x-ray brightness from the GRB afterglow generated when the ultra-relativistic material in the explosion impacts the surrounding environment. The standard explosion assumption is that a short interval of impulsive energy injection is followed by adiabatic evolution of a forward shock wave traversing local gas. In a paper summarizing our study of 117 afterglows [7]--- the most comprehensive study to date--- we found that this standard assumption is often incorrect and, in fact, that most afterglows require a sustained injection energy by the central engine.

We also studied the physics responsible for the generation of peaks in optical and x-ray afterglows [8]. We found that a sample composed of the peaks of 30 optical afterglows and 14 X-ray light curves displays a good anticorrelation of the peak flux with the peak epoch: $F_p \propto t_p^{-2.0}$ in the optical and $F_p \propto t_p^{-1.6}$ in the X-ray, the distributions of the peak epochs being consistent with each other. We investigated the ability of two forward-shock models for afterglow light-curve peaks - an observer location outside the initial jet aperture and the onset of the forward-shock deceleration - to account for those peak correlations. For both models, the slope of the F_p - t_p relation was found to depend only on the slope of the afterglow spectrum. We found that only a conical jet seen off-aperture and interacting with a wind-like medium can account both for the X-ray peak relation, given the average X-ray spectral slope $\beta_X = 1.0$, and for the larger slope of the optical peak relation. However, we also concluded that the origin of the peak flux-peak epoch correlation is, at best, tentative, because the current sample of X-ray peaks is too small to allow a reliable measurement of the F_p - t_p relation slope and because more than one mechanism and/or one afterglow parameter may be driving that correlation.

Impact on National Missions

This project pioneered new directions for constructing co-

ordinated ecosystems of persistent wide-field surveillance sensors and autonomous robotic follow-up sensors. Experience with autonomous sensor networks having a global spatial footprint combined with demonstrated ability to both handle massive real-time data-streams and extract the key actionable knowledge “on the fly” will be essential for addressing the Nation’s most challenging global security problems during the next decade. The work on this program demonstrated the power of combining persistent surveillance with autonomous fast slewing interrogation telescopes to explore fast transients and make previously impossible observations. And this work has developed new capabilities that directly impact National Missions in Space Defense, Persistent Surveillance, and Large Data to Decision.

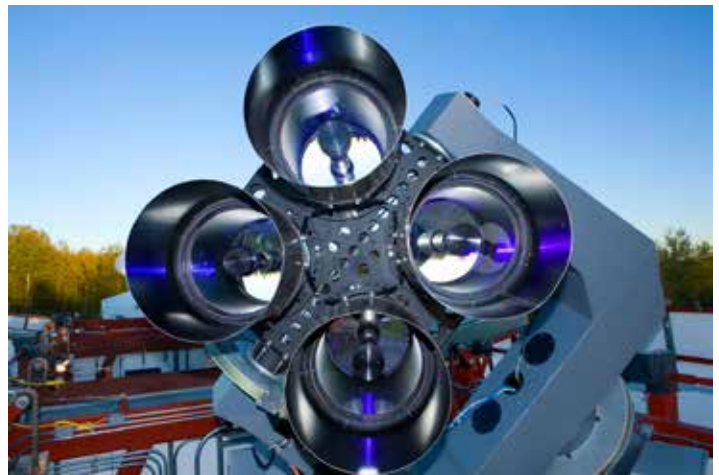

Figure 1. RAPTOR-T is one of LANL’s Thinking Robotic telescopes that is used to make rapid response observations of the optical light from gamma-ray burst explosions. The instrument is composed of four co-aligned 0.4-meter telescopes, each with a different color filter (the “T” stands for technicolor), so that simultaneous multi-color observations of the fast varying emission can be collected.

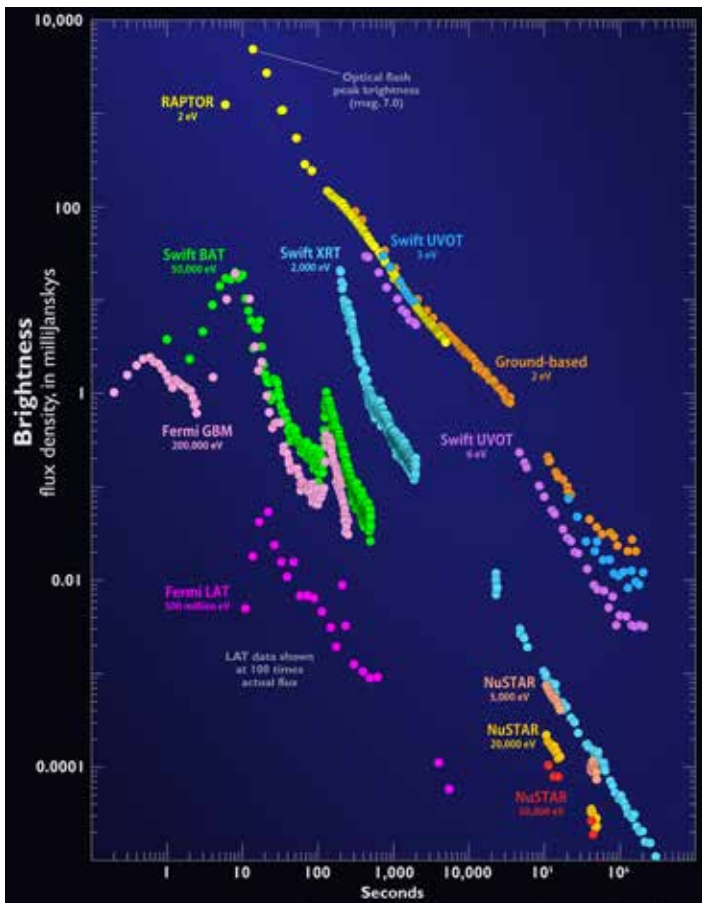

Figure 2. The optical light curve measured by our RAPTOR telescopes and the x-ray/gamma-ray light curves measured by NASA's Swift, Fermi, and NuStar satellites. The optical light measured by RAPTOR closely tracks the high-energy gamma-rays measured the Fermi LAT (Large-Area Telescope)---an unexpected relationship.

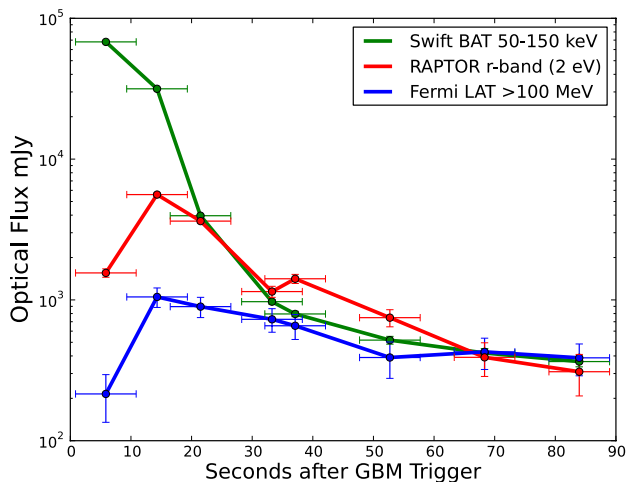

Figure 3. A comparison of the relative flux variations measured for GRB 130427A by the Fermi LAT (Large Area Telescope) at very high gamma-ray energies, RAPTOR in visible light, and the Swift BAT (Burst Alert Telescope) in low energy gamma-rays. The low

energy gamma-rays reach their peak brightness before both the visible and high-energy gamma-rays simultaneously reach their peaks.

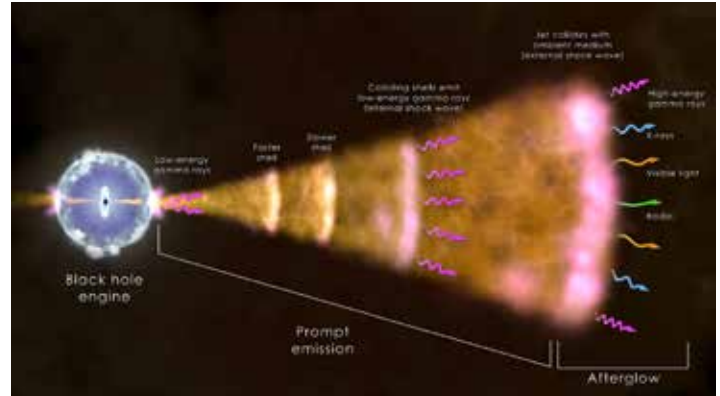

Figure 4. The components of the most common type of gamma-ray burst. The core of a massive star (left) has collapsed, forming a black hole and ejecting a jet of gas that is traveling at nearly the speed of light. The radiation we observe is generated both as clumps of material in the jet collide (internal shocks) and the jet sweeps up and interacts with its surroundings (external shocks). Our work showed a close link between the optical afterglow light and the highest energy gamma-rays and revealed that high-energy gamma-rays are generated by the external shocks that generate the afterglow emission.

References

1. Vestrand, W. T., J. A. Wren, A. Panaitescu, P. R. Woźniak, H. Davis, D. Palmer, G. Vianello, N. Omodei, S. Xiong, M. S. Briggs, M. Elphick, W. Paciesas, and W. Rosing. The bright optical flash and afterglow form the gamma-ray burst GRB 130427A. 2014. *Science*. 343 (6166): 38.
2. Ackermann, M., M. Ajello, K. Asano, and E. t. al. Fermi-LAT observations of the gamma-ray burst GRB 130427A. 2014. *Science*. 343 (6166): 42.
3. Vestrand, W. T., P. R. Woźniak, J. A. Wren, and E. t. AL. A link between prompt optical and prompt gamma-ray emission in gamma-ray bursts. 2005. *Nature*. 435 (7039): 178.
4. Akerlof, C., R. Balsano, S. Barthelmy, and E. T. AL.. Observation of contemporaneous optical radiation from a gamma-ray burst. 1999. *Nature*. 398 (6726): 400.
5. Panaitescu, A., W. T. Vestrand, and P. R. Woźniak. An external-shock model for gamma-ray burst afterglow 130427A. 2013. *Monthly Notices of the Royal Astronomical Society*. 436 (4): 3106.
6. Panaitescu, A., W. T. Vestrand, and P. R. Woźniak. Self-absorbed GeV light curves of gamma-ray burst after-

-
- glows. 2014. *Astrophysical Journal*. 788 (1): 1.
7. Panaitescu, A., and W. T. Vestrand. The possible ubiquity of energy injection in gamma-ray burst afterglows. 2012. *Monthly Notices of the Royal Astronomical Society*. 425 (3): 1669.
8. Panaitescu, A., W. T. Vestrand, and P. R. Wozniak. Peaks of optical and x-ray afterglow light curves . 2013. *Monthly Notices of the Royal Astronomical Society*. 433 (1): 759.
- Publications**
- Ackermann, M., R. Kiziah, P. Zimmer, J. D. Beason, E. Spillar, W. T. Vestrand, and M. Weeks. Alternatives for Ground-Based, Large-Aperture Optical Space Surveillance Systems. 2013. In 2013 AMOS Technical Conference. (Maui, 10-12 Sept. 2013). Vol. 1, p. 1. Maui: AMOS Maui Development Board.
- Bode, M., and W. T. Vestrand. Small and robotic telescopes in the era of massive time-domain surveys. 2012. In *New Horizons in Time-Domain Astronomy, International Astronomical Union Symposium 285*. (Oxford, England, 19-23 September 2011). Vol. 285, p. 235. Cambridge, England: Cambridge University Press.
- Filgas, R., J. Greiner, and P. Schady et al. GRB 091029: at the limit of the fireball scenario. 2012. *Astronomy and Astrophysics*. 546 (A101): 1.
- Jin, Z., S. Covino, and M. Della Valle et al. GRB 081007 and GRB 090424: The surrounding medium, outflows, and supernovae. 2013. *Astrophysical Journal*. 774 (2): 114.
- Panaitescu, A.. Synchrotron and inverse-Compton emissions from pairs formed in GRB afterglows (analytical treatment). To appear in *Astrophysical Journal*.
- Panaitescu, A., W. T. Vestrand, and P. R. Wozniak. Peaks of optical and X-ray afterglow light curves. 2013. *Monthly Notices Royal Astronomical Society*. 433: 759.
- Panaitescu, A., W. T. Vestrand, and P. Wozniak. Self-absorbed GeV light curves of gamma-ray burst afterglows. 2014. *Astrophysical Journal*. 788 (1): 1.
- Panaitescu, A., W. T. Vestrand, and P. Wozniak. An external-shock model for GRB afterglow 130427A. 2013. *Monthly Notices Royal Astronomical Society*. 436 (4): 3106.
- Panaitescu, A., and W. T. Vestrand. The possible ubiquity of energy injection in gamma-ray burst afterglows. 2012. *Monthly Notices of the Royal Astronomical Society*. 425 (3): 1669.
- Troja, E., T. Sakamoto, and C. Guidorzi et al. Broadband study of GRB 091127: a sub-energetic burst at higher redshift?. 2012. *Astrophysical Journal*. 761 (1): 1.
- Vestrand, W. T., J. Wren, A. Panaitescu, P. Wozniak, H. Davis, D. Palmer, G. Vianello, N. Omodei, S. Xiong, M. S. Briggs, M. Elphick, W. Paciesas, and W. Rosing. The bright optical flash and afterglow from the gamma-ray burst GRB130427A. 2014. *Science*. 343 (6166): 38.
- Vreeswijk, P., C. Ledoux, A. Raassen, A. Smette, P. Wozniak, W. T. Vestrand, and P. Jakobsson. Time-dependent excitation and ionization modelling of absorption-line variability due to GRB 080310. 2013. *Astronomy and Astrophysics*. 549: 22.

Nuclear and Particle Futures

Exploratory Research
Final Report

Transport by Thermodynamic Cross-terms in ICF Capsule Plasmas

Xianzhu Tang
20120395ER

Abstract

In inertially confined plasmas, plasma particle and energy transport can significantly modify the fusion yield compared with the prediction from standard radiation-hydrodynamics models. These include (1) the inter-species ion diffusion that can upset the initial optimal ratio of the two fuel ion species, the triton and the deuteron, or can atomically mix pusher ions into the fuel gas which can enhance radiative energy loss; (2) the tail ion transport that can degrade the fusion reactivity in the hot spot and recover portion of the reactivity at neighboring fuel ice layer; and (3) the hydrodynamic mix that can aggravate the aforementioned ion diffusion and free-streaming effects in thermonuclear burn, in addition to hot-spot cooling via enhanced thermal conduction energy loss. This ER project developed the fundamental theory for inter-species ion diffusion taking into account all the thermodynamic cross terms, which are baro-diffusion, electro-diffusion, electron and ion thermo-diffusion. It also advances a hybrid model that can rigorously couple tail ion transport calculation to radiation-hydrodynamics model. We have implemented this model and uncovered new physics of the so-called inverse Knudsen layer effect, in addition to a careful comparative study that places prior work in this area within our comprehensive theoretical framework and model hierarchy. Finally, we have carried out systematic studies on the detailed plasma transport physics by which hydrodynamic mix at the gas-ice interface impacts hot-spot fusion performance. A novel control approach based on external magnetic fields arises from these physics advances. It not only mitigates the adverse transport effect aggravated by the mix, but also provides a direct means to control mix in the first place.

Background and Research Objectives

The fact that NIF has not ignited to date inspires a thorough study into the fundamental physics that governs hot-spot assembly and thermonuclear burn. This ER project takes the most direct route of attack by focusing

on the fundamental physics underlying the fusion yield rate. In the most general form, the fusion yield rate is the triple product of the two reactant number densities, n_D and n_T , and the fusion reactivity $\langle\sigma v\rangle$. To maximize the product of n_D and n_T and hence the yield rate, one should prepare the target so $n_D=n_T$ everywhere. This can be easily accomplished via an equi-molar gas fill and D-T ice layer in the target preparation stage. During the hot-spot assembly in which spherical implosion increases the hot-spot density and temperature enormously, significant gradients of ion pressure, electric potential, and temperature inevitably appear in the capsule, and they can drive species separation that results in a reduced $n_D n_T$ product. A key objective of this ER is to develop a rigorous theory governing inter-species ion diffusion taking into account all the thermodynamic cross-terms including the baro-diffusion, electro-diffusion, and electron and ion thermo-diffusion.

The fusion reactivity between D and T in the multi-keV temperature range is the highest among all fusion reactions. In a plasma close to thermodynamic equilibrium, $\langle\sigma v\rangle$ is a function of ion temperature only, and scales as T^4 for $T_i=1-8$ keV, and T^2 for $T_i=8-25$ keV. To achieve better fusion performance, one needs to maximize T . For a given laser driver, the hot-spot peak pressure tends to be similar, but the temperature and hence density can vary. This can be the result of the ice ablated off into the hot spot via thermal conduction loss from the hot spot. In fact, the hot-spot mass-gain via ablating the ice provides most of the hot spot mass in the NIF point design. Hydrodynamic mix at the gas-ice interface can promote the thermal conduction energy loss from the hot spot and the mass gain, due to a drastically increased gas-ice interfacial area. Another key objective is to firmly establish the transport implication of hydrodynamic mix on hot-spot mass gain and temperature cooling, and the resulting adverse effect on fusion performance. This is to set up exploratory research that searches for mitigation strategies.

One additional subtlety concerns the fusion reactivity in an assembled target. This is fundamentally the result of the kinetic physics that ultimately determines the fusion reactivity in a plasma that deviates from a local Maxwellian, albeit only at high energy. It comes about because supra-thermal ions, usually with energy 3-4 times the thermal energy, dominate the contribution to the fusion reactivity, resulting in the so-called Gamow peak. Since fast ions have much longer collisional mean-free-path, streaming loss can be a significant concern in a hot spot that is enclosed by cold and dense fuel ice. The so-called Knudsen layer reduction of $\langle \sigma v \rangle$ can be a significant factor in small target or in large target undergoing significant hydrodynamic mix that enlarges the gas-ice interfacial area. The existing work made various heuristic assumptions to reach a simple model, some of which are in clear violation of the physical parameter ordering, for example, the pitch angle scattering should not be much faster than energy scattering, exactly the opposite of what the previous model assumed. A key objective of this project is to lay out the fundamental physical model for the tail ion transport, and derive rigorous reduced models using the correct ordering where applicable.

Scientific Approach and Accomplishments

On the inter-species ion diffusion problem, we have made two fundamental advances which give rise to a first-principle model for ion diffusion in collisional plasmas. The first is a rigorous derivation from species equation of motion of binary ion mixture, of a inter-species ion diffusion equation that captures all thermodynamic cross-terms including the baro-diffusion due to ion pressure gradient, the electro-diffusion due to the plasma ambipolar electric field, and the thermo-diffusion due to the temperature gradients of both electrons and ions [1,2,5]. We uncover the fundamental physics that baro-diffusion is the result of different ion masses, while the electron-diffusion is the result of different charge-mass ratio of the ion species [1]. Quite remarkably, we find that due to the long-range interaction of Coulomb collision, the thermo-diffusion in a plasma can be dominating, in sharp contrast with that of a neutral gas, which is usually negligible as pointed out by Landau and Lifshitz. In addition to lay out the exact formulae for the relative diffusion coefficients for baro- and electro-diffusion, which are thermodynamic quantities [2,5], we find explicit expression for the thermodiffusion coefficients in terms of the friction and thermo-force coefficients of ion-ion and ion-electron collisions [1].

The second fundamental advance is explicit calculation of the transport coefficients that enter the electron and ion thermo-diffusion coefficients [9]. This is a challenging problem since the well-known Braginskii transport equa-

tions only deal with a simple plasma of one ion species. To evaluate the transport coefficients, we need a closure calculation for two-ion-species plasmas. To this end, we follow the 21N moment method, which finds its origin in the celebrated 13N moment method of H. Grad. The result is an expression of the transport coefficients and hence thermo-diffusion coefficients for arbitrary ion mass-ratio and charge-ratio [9]. An important physics finding is that an ion mix with high-Z charge states, the thermo-diffusion dominates over baro- and electro-diffusion. Recent work by others following the Braginskii's perturbative approach recovers our prediction in the limit of large ion mass ratio. This advance in fundamental transport theory brings a new dimension in inertial confinement fusion plasma modeling.

In the area of understanding the transport implication of hydrodynamic mix, we have carried out a set of contrasting simulations that are specially designed to isolate the transport physics affected by hydrodynamic mix, namely hot-spot cooling and mass gain [11]. The primary physics subtlety is that ablation at the gas-ice interface, which is the inevitable result of thermal conduction energy loss from the hot spot, also has a stabilizing effect on the hydrodynamic instability. In other words, while mix enhances hot-spot energy loss, ablation as the result of this energy loss can substantially modify the mix. With a careful and deliberate set up, we were able to bring a resolution to this competition and find that for standard ICF shots, mix can drastically lower the fusion yield via hot-spot temperature cooling and mass gain. In contrast, for slower implosion or higher gas fill, which produces weaker drive for hydrodynamic instability, the impact of mix on fusion performance is much reduced [11].

One key advance from our research is that an external magnetic field can work in tandem with ablative stabilization and hot-spot ion viscosity to (1) not only drastically reduce hot spot thermal conduction loss via electron magnetization, (2) but also significantly reduce the level of mix at the gas-ice interface [3]. Here there is the subtle competition between magnetic insulation that reduces ablative stabilization, and need of relying on ablative stabilization of Rayleigh-Taylor modes in the direction perpendicular to the magnetic field. We resolve this competition via contrasting simulations, and find that an acceptable compromise can be reached in an intermediate field strength range, which is experimentally accessible [10]. This establishes a novel path toward mix control in ICF implosions.

In the area of kinetic modification of fusion reactivity, we performed a systematic analysis of the Fokker-Planck equation for tail ion transport, taking into account the plasma profile variation including the ambipolar electric field. This leads to a hierarchy of reduced models, of which the

simplest reproduces the previous model in the literature [7]. By contrasting the different levels of model approximation, we were able to precisely identify the cause for the failing of the current model in use, and demonstrated that a three-mode model, which takes into account the velocity space anisotropy in the tail ion distribution, is the most efficient while still reliable reduced model for fusion reactivity calculation [8,13].

On the physics front, we discovered the interesting physics of the so-called inverse Knudsen layer effect, in which the free-streaming of tail ions from the hot spot produces a surplus of fast ions in the neighboring cold and dense fuel layer, resulting in a locally enhanced fusion yield rate [4]. The spatial redistribution of fusion yield rate at the hot/cold front is of importance in setting the thermonuclear burn progression. Our extensive parameter scan establishes that in a robustly burning ICF target, the nonlocal yield recovery mostly compensates the yield rate loss from the hot spot. In a sub-ignition target, however, Knudsen layer reactivity reduction plays a dominant role [8].

The fact that the tail ion transport model must be coupled to radiation-hydrodynamics simulation to be useful brings a theoretical challenge on the self-consistency between the two. This has brought significant confusion in the interpretation of the previous heuristic model. We have taken a careful look at this and come up with a theoretical formulation that couples the tail ion kinetic equation to radiation-hydrodynamic models, via an innovative use of the Chapman-Enskog closure calculation [6]. The advance has implications beyond fusion applications in that it constitutes an alternative non-perturbation formulation for closure calculation in cases where the Knudsen number is not too small. This is a fundamental statistical physics problem, for which we have made a conceptual advance.

Impact on National Missions

The research performed under this ER brings fundamental changes in the way we compute fusion reactivity in an ICF plasma and to other inertially confined plasmas as well. Before our ER, the standard practice is to assume n_D/n_T having exactly the same ratio as the initial condition, and the fusion reactivity $\langle\sigma v\rangle$ is from tabulated data as a function of ion temperature, which is computed by integrating two Maxwellians for the reactants. After this ER, one now has the transport equation to evaluate the dynamic evolution of n_D/n_T , which can deviate strongly from its initial condition. For the fusion reactivity, one now has a hybrid model in which a non-perturbative tail ion kinetic equation is rigorously coupled to the radiation-hydrodynamic simulation. In summary, the impact of this ER manifests in a fundamental change in our evaluation of fusion yield rate

in an inertially confined plasma [12].

References

1. Kagan, , and Tang. Electro-diffusion in a plasma with two ion species. 2012. PHYSICS OF PLASMAS. 19 (8).
2. Kagan, , and X. Z. Tang. Comment on "Plasma Adiabatic Lapse Rate". 2012. PHYSICAL REVIEW LETTERS. 109 (26).
3. Srinivasan, , and Tang. The mitigating effect of magnetic fields on Rayleigh-Taylor unstable inertial confinement fusion plasmas. 2013. PHYSICS OF PLASMAS. 20 (5).
4. Tang, , C. J. McDevitt, Guo, and H. L. Berk. Fusion yield rate recovery by escaping hot-spot fast ions in the neighboring fuel layer. 2014. EPL. 105 (3).
5. Kagan, , and Tang. Thermodynamic evaluation of mass diffusion in ionic mixtures. 2014. PHYSICS OF PLASMAS. 21 (2).
6. Tang, , C. J. McDevitt, Guo, and H. L. Berk. A hybrid model for coupling kinetic corrections of fusion reactivity to hydrodynamic implosion simulations. 2014. PHYSICS OF PLASMAS. 21 (3).
7. Tang, , H. L. Berk, Guo, and C. J. McDevitt. Reduced Fokker-Planck models for fast particle distribution across a transition layer of disparate plasma temperatures. 2014. PHYSICS OF PLASMAS. 21 (3).
8. McDevitt, C. J., Tang, Guo, and H. L. Berk. A comparative study of the tail ion distribution with reduced Fokker-Planck models. 2014. PHYSICS OF PLASMAS. 21 (3).
9. Kagan, , and Tang. Thermo-diffusion in inertially confined plasmas. 2014. PHYSICS LETTERS A. 378 (21): 1531.
10. Srinivasan, B., and X. Z. Tang. Mitigating Rayleigh-Taylor mix at the gas-ice interface in inertial confinement fusion targets via a combination of magnetic, viscous, and ablative stabilization . 2014. EPL (Europhysics Letters). 107: 65001.
11. Srinivasan, B., and X. Z. Tang. Role of hydrodynamic instability growth in hot-spot mass gain and fusion performance of inertial confinement fusion implosions. 2014. Physics of Plasmas. 21 (10): 102704.
12. Tang, X. Z., Z. Guo, G. Kagan, C. J. McDevitt, and B. Srinivasan. Plasma effects on thermonuclear yield rate in the presence of hydrodynamic mix. Journal of Phys-

13. McDevitt, C. J., X. Z. Tang, Z. Guo, and H. L. Berk. Calculation of the tail ion distribution for a spherically symmetric hot spot. 2014. *Physics of Plasmas*. 21 (10): 102705.

Publications

- Kagan, , and Tang. Thermodynamic evaluation of mass diffusion in ionic mixtures. 2014. *PHYSICS OF PLASMAS*. 21 (2).
- Kagan, , and Tang. Thermo-diffusion in inertially confined plasmas. 2014. *PHYSICS LETTERS A*. 378 (21): 1531.
- Kagan, G., and X. Tang. Electro-diffusion in a plasma with two ion species. 2012. *Physics of Plasmas*. 19 (8): 082709.
- Kagan, G., and X. Z. Tang. Comment on "Plasma Adiabatic Lapse Rate". 2012. *Physical Review Letters*. 109: 269501.
- McDevitt, C. J., Tang, Guo, and H. L. Berk. A comparative study of the tail ion distribution with reduced Fokker-Planck models. 2014. *PHYSICS OF PLASMAS*. 21 (3).
- McDevitt, C. J., X. Z. Tang, Z. Guo, and H. L. Berk. Calculation of the tail ion distribution for a spherically symmetric hot spot. 2014. *Physics of Plasmas*. 21 (10): 102705.
- Srinivasan, , and Tang. The mitigating effect of magnetic fields on Rayleigh-Taylor unstable inertial confinement fusion plasmas. 2013. *PHYSICS OF PLASMAS*. 20 (5).
- Srinivasan, B., and X. Z. Tang. Mitigating Rayleigh-Taylor mix at the gas-ice interface in inertial confinement fusion targets via a combination of magnetic, viscous, and ablative stabilization . 2014. *EPL (Europhysics Letters)*. 107: 65001.
- Srinivasan, B., and X. Z. Tang. Role of hydrodynamic instability growth in hot-spot mass gain and fusion performance of inertial confinement fusion implosions. 2014. *Physics of Plasmas*. 21 (10): 102704.
- Tang, , C. J. McDevitt, Guo, and H. L. Berk. A hybrid model for coupling kinetic corrections of fusion reactivity to hydrodynamic implosion simulations. 2014. *PHYSICS OF PLASMAS*. 21 (3).
- Tang, , C. J. McDevitt, Guo, and H. L. Berk. Fusion yield rate recovery by escaping hot-spot fast ions in the neighboring fuel layer. 2014. *EPL*. 105 (3).
- Tang, , H. L. Berk, Guo, and C. J. McDevitt. Reduced Fokker-Planck models for fast particle distribution across a transition layer of disparate plasma temperatures.

Graphene Shield Enhanced Photocathodes

Nathan A. Moody
20140486ER

Abstract

This project has taken the first key steps toward the strategic integration of graphene in accelerator design and engineering. This report addresses why this is important and how these key steps were accomplished. Graphene is presently the world's most celebrated material and as a strictly 2D monolayer honeycomb of carbon atoms, it is the thinnest known material in the universe and the strongest ever measured [1]. Relevant to engineering are its outstanding properties: ultra-high electrical and thermal conductivity, optical transparency, impermeability to all molecular gases, high charge mobility, and ability to sustain extreme current densities. Each of these verified and accessible characteristics allow us to consider graphene as an engineering solution to some of the outstanding problems in accelerator design. The application we target in this project is in enhancing the lifetime of photoemissive surfaces by integrating graphene as a passivating, transparent layer onto electron sources. Electron accelerators require a source of electrons, a cathode, and in most applications cathode lifetime is a limiting factor due to surface contamination of background gases or other mechanisms that otherwise compromise the surface. We have developed an engineering path and several prototypes that demonstrate how graphene can be effective as a gas barrier to the chemically sensitive surface of photo-excited cathodes. Specifically, we have demonstrated the use of graphene as a monolayer shield applied to several metallic photocathodes.

Background and Research Objectives

Among the extraordinary properties of graphene, which have been extensively investigated and subsequently exploited across multiple disciplines, is its general capacity to form an ultra-thin hermetic barrier to gases [2]. Basic applications of this property at atmospheric pressure have been demonstrated in multiple ways, including prevention of oxide layers on metals and hermetic isolation of organic photocells [3]. LANL is the first to apply graphene's ultra-barrier properties to complex

vacuum environments encountered in accelerator design and engineering, which include extremes in temperature, dynamic partial pressure gas composition, electric field gradient, and incident drive laser optical intensity. Photoemission has become widely used and is conceptually convenient mechanism to launch a high quality electron beam with high brightness and pre-bunching [4,5], which is necessary in almost all next-generation accelerator-based light sources [6,7]. Progress in advanced accelerator engineering is so critically tied to advances in electron sources that the DOE has identified it as a top decadal priority in its strategic R&D road-map. Photocathodes are specially prepared metallic or semiconductor surfaces which emit an electron beam via the photoemission effect. The beam is photo-gated because emission is dictated by the pulse structure of the incident light.

The need in photocathode design is a realistic methodology for lifetime extension, without compromises in other performance metrics, including spectral response, quantum efficiency, and beam emittance [8]. Demonstrating such a methodology is the goal of this project and it has implications in terms of both design and operation of large user facilities (e.g., next generation light sources) utilizing high energy electron beams, as it would enable performance gain, reduction in operational costs, and simplification of design and construction. Graphene's ability to provide barrier isolation to molecular gases is fundamental to this application and our work suggests that under certain conditions, a few (3-5) monolayers graphene does not significantly alter substrate work function. Importantly, this means that its overlay on the cathode surface does not inhibit photoemission, since the few layers are evidently transparent to low energy electrons leaving the surface. Lastly, its optical transparency allows for the widest flexibility of cathode design by allowing for both reflection and transmission mode photoemission.

Scientific Approach and Accomplishments

Only recently has the capabilities emerged to grow and transfer large area monolayer films of sufficiently high quality for photocathode applications [9]. Large area coverage is required because most photocathode surfaces span multiple square millimeters or more, depending on laser spot size and other considerations. Some of the recent advances in large area graphene growth and transfer have occurred at LANL [3,10,11] and we have begun using an adaptation of a charged-particle beam angular scattering measurement to quantitatively interrogate the film quality (i.e., pinhole density) as part of a verification process.

Demonstration of cathode lifetime enhancement using graphene is a multi-step problem requiring stepwise techniques including growth, transfer, and characterization. Schematically, the integration of a graphene layer onto a transmission-mode photocathode is shown in Figure 1. Note that for almost all cathodes, the application of the graphene layer occurs in a vacuum environment. We have developed two engineering approaches in this regard: 1.) transfer of graphene onto a pre-grown cathode surface, and 2.) growth of the cathode surface onto a wire-mesh suspended graphene film. In either case, a key engineering step is the ability to grow and then transfer graphene reliably onto a target surface or wire-mesh scaffold.

Three graphene derivatives were studied, in order to minimize risk in the overall approach and to enable the most flexibility in addressing application-specific requirements of cathode lifetime enhancement. These include: graphene oxide (GO), reduced graphene oxide (rGO) and chemical vapor deposition grown graphene (CVD-Gr). For GO and rGO preparation, the first step is oxidation and chemical exfoliation of graphite powder using the modified Hummer's method [12,13] or Tour's method [14], both of which have led to the large-area growth capability needed for cathode gas barriers. GO consists of sheets of graphene that exhibit microscopic lateral dimension and are decorated with oxygen functional groups. Sonication of the GO suspension was not performed to prevent pinholes from forming which would undermine the film's hermeticity. Following suspension in aqueous solution, thin GO films of varying thickness were obtained by vacuum filtration of various solution volumes through a filtering membrane. At this point, the assembled thin films were either transferred from the membrane onto a substrate for immediate characterization or additional processing (annealing) was performed to reduce the thin films to rGO. The selection between GO, rGO, or pristine CVD-grown graphene depends largely upon details of the given application. For example, GO and rGO have (by definition) high defect densities which enable gas diffusion pathways (a trait we

wish to suppress in gas barrier applications). However, by adding one layer onto the next, the effect of any one defect is mitigated because defects do not coincide layer-to-layer. Furthermore, larger areal samples of GO and rGO can be grown and transferred as compared to CVD-grown samples. CVD yields fewer defects and also thinner films per unit layer. A comparison between graphene and GO was an outcome of this project and the results are summarized in Figure 2.

Successful transfer of graphene and graphene-derived films are obviously critical to their practical use in cathode lifetime enhancement. Prior to transfer onto surrogate cathode substrates, we first transferred GO and rGO onto nickel wire meshes with line densities ranging from 80 to 333 lines per inch. This study was undertaken in order to show how graphene can span an open area and also to utilize a beam-based measurement to estimate pinhole density. This latter technique allows for quantitative evaluation of defects as revealed by the angular scattering of an incident krypton ion beam at energies from 3-10 kilo electron volts. These measurements confirmed that rGO spanned the open area in the mesh with fewer pinholes than a much thicker control sample fabricated using thermally deposited amorphous carbon. Measurement of future samples using this technique could allow for detection of process-induced changes in film quality. Transfer of GO films onto the various wire meshes was successful, as shown in Figure 3. The goal of the wire-mesh transfer study was to determine the open area over which GO could span without delaminating or tearing. It was determined that for a 55nm thick graphene film, a hole diameter of up to 2mm could be spanned quite reliably. Mild heating (less than 100° C) was required in order to control the tension on the suspended graphene films as the aqueous solution evaporated during the transfer process.

In addition to transferring graphene to wire mesh scaffolds, we also developed and demonstrated procedures to transfer graphene onto metallic cathode substrates. The first cathode substrates to receive graphene deposition were gold (a), copper (b), and glass slide (c), as shown in Figure 4. Each of these examples illustrates successful transfer of single layer graphene with large area. Transfer of large area (~1 square centimeter) CVD graphene and rGO films was a major milestone in this effort and transfer quality (i.e., no tears or islands) was verified using optical and scanning electron microscopy. Photoemission from both un-coated and CVD graphene-coated copper was measured using a UV arc lamp and a 300 volt biased collector circuit using a calibrated ammeter. In each case, the arc lamp spot size remained the same as did all other experimental parameters, including pressure which was in

the nanoTorr range. When the UV spot was shown on each sample, the amount of photocurrent was roughly the same as shown in Figure 5. Because spot size and lamp intensity did not change, the fact that photoemission remained the same when graphene was added shows that the presence of graphene does not significantly alter the photoemission process (which we hypothesize is due to the work function and barrier width remaining the same). Intuitively, we expect this to become less and less valid as more layers of graphene are added. Such detailed investigations are suggested in follow-on efforts.

In summary, this project at LANL has introduced a new application for graphene ultra-barriers: lifetime extension of photoemission cathodes for advanced accelerator applications. The results obtained provide constitute key demonstrations showing feasibility of growth, transfer, and initial characterization of GO, rGO, and CVD-grown graphene. A summary list of accomplishments include:

- Development and demonstration of GO and rGO growth techniques
- Demonstration of single layer CVD graphene growth with low defects
- Ability to transfer GO and rGO films to wire meshes of various open areas ranging from 61 – 283 square microns.
- Determined the largest spanning area for various thicknesses of GO films
- For 5nm-thick films, the spanning area was 61 x 61 microns
- For 55nm-thick films, the spanning area was 3 square millimeters
- Performed feasibility study which compares the properties of CVD-grown graphene and GO (this study also shows where future work would be most effectively focused)
- Engineered two methods for integrating graphene barrier films into photocathode devices, including a potential approach to atmospherically stable photocathodes
- Successfully transferred multiple graphene and GO layers onto metallic photocathodes
- Successfully transferred single layer (1nm thick) graphene to a gold and copper photocathode
- Performed photoemission studies from graphene-coat-

ed copper cathode verifying that photoemission from copper persists even with graphene coating applied.

- Successfully transferred single layer (1nm thick) graphene to an alkali-based photocathode without any tears.
- Developed a procedure to control the tension in the transferred graphene films (via temperature control) which prevents both tearing and wrinkling in the resulting samples.

All the above techniques are compatible with known photocathode growth recipes and the general requirements of high vacuum systems. As part of this project, the concept and methods for protecting photocathodes using graphene barrier films was awarded a patent (US patent number 8,823,259) and the work was presented in a conference publication.

Impact on National Missions

The largest impact of this work is in potentially dramatic improvements to accelerator capability at LANL. Cathode improvements are particularly relevant in light of the signature science facility MaRIE and other programmatic accelerator needs at the Lab. The simplification of existing emission schemes translates directly to a reduction in size and complexity of accelerators, which is among the dominant needs in the field.

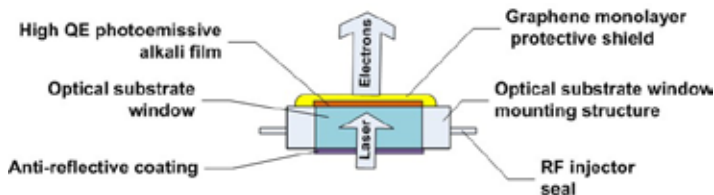

Figure 1. Overlayment of graphene or graphene-derived films on chemically sensitive photocathode surface.

	Graphene	GO
Adhesion to hydrophilic surfaces	X	○
Adhesion to hydrophobic surfaces	○	X
Ease of thicker/free-standing film prep (50nm)	X	○
Ease of single layer films prep (1nm)	○	X
Ease of few layer films prep (5nm)	△	○
Ease of chemical functionalizations to tune interlayer distance & chemical properties	X	○
Transfer using PMMA support	○	○
Gas barrier property proven at LANL	X	○
Solution processability	X	○
Ease of film morphology control	X	○
Defect-less atomic structure	○	X

Figure 2. Overview comparison chart of graphene and graphene-oxide shield film capabilities: X = not feasible; O = ready/demonstrated; triangle = possible/complex.

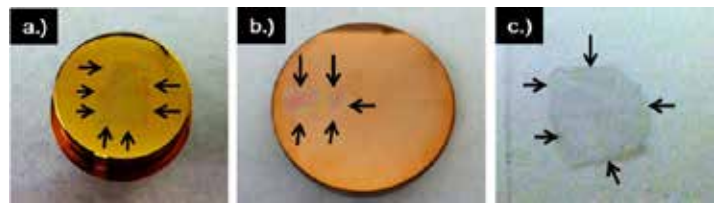

Figure 4. Cathode substrates a.) gold, b.) copper, and c.) glass showing successful single layer chemical vapor deposition (CVD) graphene transfer with no tears or wrinkles.

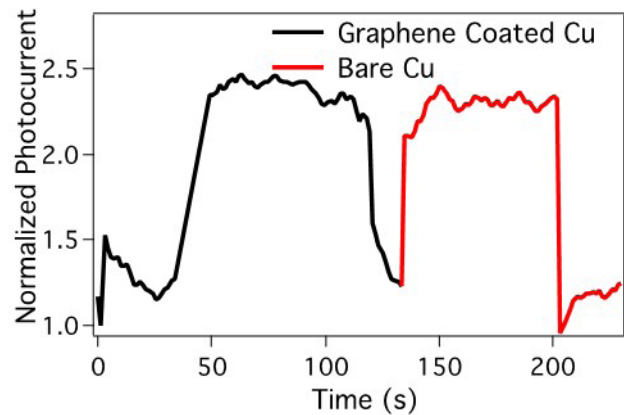

Figure 5. Preliminary photoemission results showing that few layer graphene films do not alter photoemission process, as evidenced by comparing ultra-violet emission from coated and un-coated copper sample.

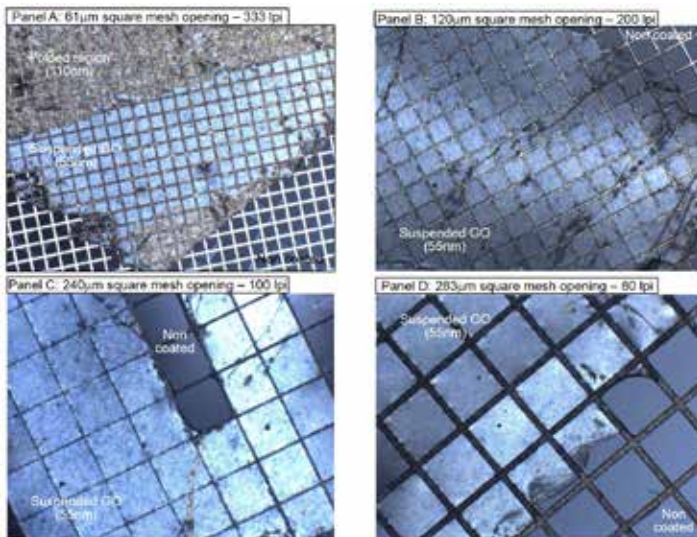

Figure 3. Suspended graphene oxide (GO) thin films, all 55nm thick, shown spanning various sizes of nickel electro-formed mesh grids: Panel A shows GO spanning a 61 square micron mesh opening, or a mesh density of 333 lines per inch (lpi); Panel B shows GO spanning a 120 square micron mesh opening, or a mesh density of 200 lpi; Panel C shows GO spanning a 240 square micron mesh opening, or a mesh density of 100 lpi; Panel D shows GO spanning a 283 square micron mesh opening, or a mesh density of 80 lpi. The conclusion from these panels is that GO films can span an open area of at least 283 square microns. The ability to suspend graphene on a wire mesh allows for growth of cathode films directly onto the graphene itself.

References

- Geim, A. K.. Graphene: status and prospects. 2009. Science. 324 (5934): 1530.
- Bunch, J. S.. Impermeable atomic membranes from graphene sheets. 2008. Nano Letters. 8 (8): 2458.
- Yamaguchi, H.. Reduced graphene oxide thin films as ultrabarrriers for organic electronics. 2014. Advanced Energy Materials. 4 (1300986): 1.
- Barletta, W. A.. Accelerator Physics for Future Light Sources . 2009. Report from BESAC: Department of Energy's Office of Science .
- Dowell, D. H.. Cathode R&D for future light sources. 2010. Nuclear Instruments and Methods in Physics Research Section A: Accelerators, Spectrometers, Detectors and Associated Equipment. 622 (3): 685.
- Carlsten, B. E.. New source technologies and their impact on future light sources. 2010. Nuclear Instruments and Methods in Physics Research Section A: Accelerators, Spectrometers, Detectors and Associated Equipment. 622 (3): 657.
- Katsouleas, T. C.. Scientific Assessment of High-Power

Free-Electron Laser Technology. 2009. The National Academies Press .

8. Buzulutskov, A.. The protection of KCsSb photocathodes with CsBr films. 1997. Nuclear Instruments and Methods in Physics Research Section A: Accelerators, Spectrometers, Detectors and Associated Equipment. 400 (1): 173.
9. Eda, G.. Large-area ultrathin films of reduced graphene oxide as a transparent and flexible electronic material. 2008. Nature Nano. 3 (5): 270.
10. Bansal, T.. New insights into the density of states of graphene oxide using capacitive photocurrent spectroscopy. 2012. Carbon. 50 (3): 808.
11. Galande, C.. Quasi-Molecular Fluorescence from Graphene Oxide. 2011. Nature Scientific Reports. 1 (85): 1.
12. Hummers, W. S.. Preparation of Graphitic Oxide. 1958. Journal of the American Chemical Society. 80 (6): 1339.
13. Kovtyukhova, N. I.. Layer-by-Layer Assembly of Ultrathin Composite Films from Micron-Sized Graphite Oxide Sheets and Polycations. 1999. Chemistry of Materials. 11 (3): 771.
14. Marcano, D. C.. Improved Synthesis of Graphene Oxide. 2010. ACS Nano. 4 (8): 4806.

Publications

Moody, N., H. Yamaguchi, G. Gupta, and A. Mohite. Graphene shield-enhancement of photosensitive surfaces and devices . 2014. In Micro- and Nanotechnology Sensors, Systems, and Applications VI, 908333 (June 25, 2014). (Baltimore, 5-9 May 2014). Vol. 9083, First Edition, p. 9083331. Bellingham, Washington: SPIE.

Nuclear and Particle Futures

Postdoctoral Research and Development
Continuing Project

3D Turbulent Magnetic Reconnection Experiments and Simulations

Scott C. Hsu
20120768PRD3

Introduction

Plasma fills most of the universe, including the interstellar medium and stellar interiors. Because plasmas are strongly affected by electric and magnetic fields, they exhibit quite complex behavior. While the particles in most plasmas have modest charges, dusty plasmas are composed of particles (the dust grains) that can have very large charges – perhaps as high as tens of thousands. For this reason, dusty plasmas have further exotic behavior; for example, they can crystallize and form matter more similar to liquids and solids. Not surprisingly then, the properties of such plasmas are currently not well understood. Here, we are interested in some basic properties of such plasmas and will focus primarily on diffusion and waves in these systems. We use specialized tools, such as molecular dynamics simulations, to analyze the physical properties. In particular, we plan to examine transport in magnetized dusty plasmas and the wave properties in dusty plasmas subjected to external force fields.

This work explores the cutting edge area of what is referred to as anomalous properties; that is, properties that are not well described by standard models. For example, standard model for diffusion is based on Fick's Law, which leads to the standard diffusion equation. However, it not clear today whether such a picture holds in two dimensional systems or with very strong magnetic fields. Understanding such novel transport processes is crucial for understanding diffusive mixing in a variety of applications, such as material mixing in experiments performed at a variety of Department of Energy facilities (e.g., Omega, Z, NIF, and LCLS).

Benefit to National Security Missions

One of the missions undertaken by DOE Office of Science is Fusion Energy Sciences. Plasma science forms the basis for research that is needed to establish our ability to harness the power of the stars in order to generate fusion energy on earth. The research required for fu-

sion energy's success is intimately tied to rich scientific questions about some of nature's most extreme environments, inside and outside of stars, and has practical implications to industry beyond energy as well. The impact of a fusion energy source will be huge, as energy drives much of our domestic and foreign policies. A major fusion energy scenario requires magnetized plasmas, and the situation in real life is fully 3D. Our proposed research speaks directly to the fundamental science of magnetized plasmas.

NASA also has a mission of Science, as we explore the Earth, solar system and universe beyond, to reap the benefits of Earth and space exploration for society. Our research project aims to unravel some fundamental questions about how magnetic structure "works" in three dimensions.

Progress

The RSX team executed experimental campaigns to characterize the evolution of flux ropes focusing on diagnostic measurements of electron temperature, plasma density, magnetic field, and ion flow velocity. The objective was to obtain a full 3D dataset, from which derived quantities could be inferred, such as electrical current density, electron flow velocity, and electron pressure. This full set of measured and inferred quantities allows the team to analyze the dynamics of flux ropes comprehensively and systematically. Nearly 3000 experimental shots were obtained to characterize the flux rope dynamics in four different planes. Improvements to the hardware systems were made and additional diagnostics were implemented during this period as well.

Future Work

We finished one manuscript on the diffusion of 2D dusty plasmas with perpendicular magnetic field, and the manuscript has been submitted to Phys. Rev. E for review. In this manuscript, we discovered that, with stronger magnetic field, the motion of dust particles tends to

be superdiffusive. This is a very surprising result, but we have not fully understood it, so that a clear explanation is still lacking. We will dig into our simulation data further, using more diagnostics such as velocity distribution function and probability distribution function, to understand superdiffusion better, enabling a clear explanation for the next manuscript. We also want to study the shear stress behavior of this system to see how shear viscosity changes as the external magnetic field changes.

Some preliminary results were competed on the diffusion of 2D dusty plasmas under 1D periodic substrates, using our adapted simulation codes. No one has done similar dusty plasma simulations. We will perform more systematic simulations with more data points. Besides diffusion, we will also calculate the phonon spectra of this system. We will study how the phonon spectra changes as the substrate width and strength change. We also generate a soliton in this system to observe how soliton propagates, and how the propagation is affected by the substrates.

We will collaborate with other group members, especially Dr. Mathieu Marciante, in the project of soliton propagation in 2D dusty plasma simulations. In this project, we will use our simulations to verify some conclusions predicted by theorists.

Conclusion

Results from molecular dynamical simulations will provide new fundamental insight into the behavior of dusty plasmas under the influence of a uniform magnetic field and in the presence of a 1D periodic electric field. Our simulation results will both help interpret new results from the “Magnetized Dusty Plasma Experiment” at Auburn University, and/or provide ideas for possible future dusty plasma experiments with electrical substrates. These results will have strong impact on soft condensed matter physics in the understanding of dynamics of colloids and granular materials.

Publications

Feng, Y. a. n., Goree, B. i. n. Liu, T. P. Intrator, and M. S. Murrillo. Superdiffusion of two-dimensional Yukawa liquids due to a perpendicular magnetic field. 2014. PHYSICAL REVIEW E. 90 (1).

Feng, Y., J. Goree, and B. Liu. Longitudinal viscosity of two-dimensional Yukawa liquids. 2013. PHYSICAL REVIEW E. 87 (1): -.

Goree, , B. i. n. Liu, and Y. a. n. Feng. Diagnostics for transport phenomena in strongly coupled dusty plasmas. 2013. PLASMA PHYSICS AND CONTROLLED FUSION. 55 (12).

Intrator, T. P., Dorf, Sun, Feng, Sears, and Weber. Laboratory observation of magnetic field growth driven by shear flow. 2014. PHYSICS OF PLASMAS. 21 (4).

Intrator, T. P., Sun, Dorf, J. A. Sears, Feng, T. E. Weber, and H. O. Swan. Flux ropes and 3D dynamics in the relaxation scaling experiment. 2013. PLASMA PHYSICS AND CONTROLLED FUSION. 55 (12).

Sears, J., Y. Feng, T. P. Intrator, T. E. Weber, and H. O. Swan. Flux rope dynamics in three dimensions. 2014. Plasma Physics and Controlled Fusion. 56: 095022.

Nuclear and Particle Futures

Postdoctoral Research and Development
Continuing Project

Theoretical Investigation of Nucleon and Nuclear Structure at Very High Energies

Ivan M. Vitev
20130783PRD2

Introduction

The theoretical study and experimental exploration of the internal structure of nucleons (protons and neutrons) and nuclei are of fundamental importance to science and have recently entered a new exciting phase. In the past decades an understanding of nucleons in terms of quarks and gluons (partons) has successfully emerged. Progress has been made in constructing a “one-dimensional” picture of the nucleon, in the sense that we “only” know about the longitudinal motion of partons in fast moving protons and neutrons. However, the parton’s motion that is perpendicular (transverse) to the proton momentum is still largely unknown and urgently needed in order to construct the 3-dimensional image of the proton. Since the transverse momentum component is usually much smaller than parton’s longitudinal component, it is critical to develop accurate theoretical tools to extract this information. We propose two unique ways to attack this problem. One is through the transverse spin dependence of experimental observables, as transverse spin can correlate with the parton transverse momentum. The other way is through a discovery of a novel nuclear dependence, as the small transverse motion can be amplified by the nuclear size. We will develop the first solid theoretical framework that can utilize both methods to pinpoint the partons’ transverse motion in both the proton and the big nucleus.

Benefit to National Security Missions

This project ties directly into the Laboratory mission in scientific innovation and discovery. Understanding the structure of the nucleon is central to the nuclear physics component of the National Science Foundation (NSF) and Department of Energy (DOE) Office of Science portfolios. Specifically, this project will provide new and unique 3 dimensional imaging information for the nucleon structure at the $\sim 20\%$ level. It will also give essential insights into how the quark and gluon dynamics are modified in a large nucleus. It will produce theoretical tools for the community to accurately and reliably

extract such information from data collected in the US and abroad. It also provides much-needed theoretical guidance for and interpretation of the experimental results from the flagship nuclear physics program in US and abroad. This project will also help firm the scientific case for a future Electron Ion Collider.

Progress

Since the beginning of fiscal year 2014, we have made significant progress toward the ultimate goal of this project – to understand the internal landscape of nucleons and nuclei at a fundamental level. We have written 4 papers and 3 of these works are published already in: Physical Review Letters, Physical Review D, and Journal of High Energy Physics. The last manuscript has been submitted to Physical Review Letters, and we expect it to be published soon. We also organized the QCD Evolution 2014 Workshop in Santa Fe, NM, and Kang was the co-chair of this prestigious meeting. Our research direction is one of the hot topics discussed there and the workshop was a success.

Two highlights of our work concern the transverse motion of quarks and gluons (collectively called partons) in nucleons and nuclei. In a recent paper published in Physical Review D, we studied the evolution of the Sivers effect (special asymmetric distribution of produced particles in reactions with a polarized target) in both semi-inclusive deep inelastic scattering (SIDIS) (electron proton scattering that produces a strongly-interacting particle in the final state) and Drell-Yan production (DY) (proton-proton scattering that produces a electron-positron pair in the final state). The relevant function – the so-called Sivers function - contains important information about the partons’ transverse momentum distribution inside a proton. For the first time, we found a suitable spin-independent representation of the non-perturbative Sudakov factor (a key ingredient in the energy evolution formalism for such reactions). Our new work gives a good description of the community’s ex-

perimental data on the transverse momentum distribution in SIDIS, DY production, and W/Z boson production. With this Sudakov factor at hand, we performed global fitting of all the experimental data on the Sivers asymmetry in SIDIS from HERMES, COMPASS and Jefferson Lab. We then made predictions for the Sivers asymmetry in DY lepton pair and W production that can be compared to the future experimental measurements to test the predicted sign change of the Sivers functions between SIDIS and DY processes and further constrain the Sivers functions in unexplored kinematic regions.

In another paper, published in Physical Review Letters, we computed to high accuracy (next-to-leading order) the transverse momentum broadening in semi-inclusive hadron production in deep inelastic electron-nucleus scattering. The complexity of this calculation arises from the large size of the nucleus. Such transverse momentum broadening is generated when a parton (quark or gluon) passes through the big nucleus and undergoes multiple scattering, and thus it reveals the characteristic size of the transverse momentum kick from the partons and, in turn, the parton's typical transverse momentum inside the large nucleus. Such information is contained in complex correlation functions. From our next-to-leading order calculation, we were able to extract the momentum scale evolution (energy dependence) of this four-parton correlation function. Thus our calculation also demonstrates for the first time how the strength of the multiple scattering inside large nuclei changes when one probes it at different momentum scales (different resolution).

Future Work

We have studied the energy evolution of the Sivers asymmetry measured at HERMES, COMPASS, and Jefferson Lab (the experimental facilities for polarized reactions physics). Our studies were based on semi-inclusive deep inelastic scattering (SIDIS) (the process of electron-proton scattering to produce a strongly-interacting particle in the final state).

To further test the QCD evolution and understand the spin correlation in the fragmentation process, we plan to perform the similar global analysis of Collins spin asymmetry measured in both SIDIS at HERMES, COMPASS, and Jefferson Lab, as well as the electron-positron annihilation experiments at BarBar and Belle (names of experiments). The advantages of this study are two-fold: (1) they are two different processes, thus we will be able to test the universality of the Collins fragmentation function (the function that describes how the fundamental constituents of the standard model, quarks and gluons, evolve into experimentally observable elementary particles such as pions and kaons) and the associated strong interaction dynamics. (2)

These reactions occur at very different center of mass energies and allow us to determine the energy dependence of the Collins function (its evolution).

Conclusion

We will develop a new consistent theoretical formalism for evaluating the cross sections in polarized reactions with protons and nuclei. We will also investigate the novel nuclear dependence of experimental spin observables in both electron-nucleus and proton-nucleus collisions. We will use these theoretical formalisms to interpret the experimental data collected at the major experimental facilities in the US and abroad and extract the valuable information on the parton's transverse motion. This will provide unique 3-dimensional imaging information for the proton and nuclear structure at high energies.

Publications

- Aschenauer, E. C., A. Bazilevsky, K. Boyle, R. Fatemi, C. Gagliardi, M. Grosse-Perdekamp, Z. B. Kang, Y. Kovchegov, and J. Lajoie. The RHIC Spin Program: Achievements and Future Opportunities. 2013. White Paper on RHIC spin physics to the Tribble Panel and Nuclear Science Advisory Committee.
- Dai, L. Y., Z. B. Kang, A. Prokudin, and I. Vitev.
- Echevarria, M. G., A. Idilbi, Z. B. Kang, and I. Vitev. QCD Evolution of the Sivers Asymmetry. 2014. PHYSICAL REVIEW D. 89: 074013.
- Gamberg, L., Z. B. Kang, A. Metz, D. Pitonyak, and A. Prokudin. Left-right spin asymmetry in $\ell N \uparrow \rightarrow h X$. To appear in PHYSICAL REVIEW D.
- Gamberg, L., Z. B. Kang, and A. Prokudin. Indication on the process-dependence of the Sivers effect. 2013. Physical Review Letters. 110 (23): 232301.
- Gamberg, L., and Z. B. Kang. Single transverse spin asymmetry of prompt photon production. 2012. Physics Letters B. 718 (1): 181.
- Huang, J., Z. B. Kang, and I. Vitev. Inclusive b-jet production in heavy ion collisions at the LHC. 2013. PHYSICS LETTERS B. 726: 251.
- Kang, Z. B.. QCD and RHIC spin physics. Invited presentation at 2012 Fall Meeting of the APS Division of Nuclear Physics. (Newport Beach, CA, 24-27 Oct. 2012).
- Kang, Z. B.. Polarized p+A, single spin asymmetries. Invited presentation at BNL-LANL-RBRC Joint Workshop on The Physics of p+A Collisions at RHIC. (Upton, NY, 7-9 Jan. 2013).
- Kang, Z. B.. Single transverse spin asymmetries in polarized SIDIS and pp scattering. Invited presentation at The 5th

- Workshop of the APS Topical Group on Hadronic Physics. (Denver, CO, 10-12 Apr. 2013).
- Kang, Z. B.. Forward physics from a theoretical perspective. Invited presentation at STAR Meeting on eSTAR Letter of Intent, Forward-Upgrades and Results from U+U Collisions. (Los Angeles, CA, 28-30 Aug. 2013).
- Kang, Z. B.. Double parton fragmentation function and its evolution in quarkonium production . 2014. In QCD Evolution 2013. (Newport News, VA, 6-10 May 2014). Vol. 25, p. 1460040 . Singapore: International Journal of Modern Physics.
- Kang, Z. B.. Unique opportunities in p+A collisions at RHIC and LHC. Invited presentation at APS Division of Nuclear Physics 2014 Long-range plan: Joint Town Meetings on QCD. (Philadelphia, PA, 13-15 Sept. 2014).
- Kang, Z. B.. Nucleon spin: longitudinal, transverse, and evolution. Invited presentation at 2014 RHIC and AGS Annual Users Meeting. (Upton, NY, 17-20 June 2014).
- Kang, Z. B.. TMD evolution of Sivers asymmetry. Invited presentation at Studies of 3D Structure of Nucleon. (Seattle, WA, 24-28 Feb. 2014).
- Kang, Z. B.. QCD evolution of TMDs: what works?. Invited presentation at Indiana-Illinois Workshop on Fragmentation Functions. (Bloomington, IN, 12-14 Dec. 2013).
- Kang, Z. B.. TMDs: Mechanisms/universality with ep and pp collisions. Invited presentation at QCD Frontier 2013. (Newport News, VA, 21-22 Oct. 2014).
- Kang, Z. B., E. Wang, X. N. Wang, and H. Xing. Next-to-Leading QCD Factorization for Semi-Inclusive Deep Inelastic Scattering at Twist-4 . 2014. Physical Review Letters. 112: 102001 .
- Kang, Z. B., E. Wang, X. N. Wang, and H. Xing. Transverse momentum broadening in semi-inclusive deep inelastic scattering at next-to-leading order . PHYSICAL REVIEW D.
- Kang, Z. B., I. Vitev, E. Wang, H. Xing, and C. Zhang. Multiple scattering effects on heavy meson production in p+A collisions at backward rapidity . PHYSICS LETTERS B.
- Kang, Z. B., I. Vitev, and H. Xing. Transverse momentum-weighted Sivers asymmetry in semi-inclusive deep inelastic scattering at next-to-leading order. 2013. Physical Review D. 87 (3): 034024.
- Kang, Z. B., I. Vitev, and H. Xing. Next-to-leading order forward hadron production in the small-x regime: the role of rapidity factorization . 2014. PHYSICAL REVIEW LETTERS. 113: 062002.
- Kang, Z. B., I. Vitev, and H. Xing. Multiple scattering effects on inclusive particle production in the large-x regime . 2013. PHYSICAL REVIEW D. 88: 054010.
- Kang, Z. B., R. Lashof-Regas, G. Ovanesyan, P. Saad, and I. Vitev. Jet quenching phenomenology from soft-collinear effective theory with Glauber gluons. PHYSICAL REVIEW LETTERS.
- Kang, Z. B., S. Mantry, and J. W. Qiu. Probing nuclear dynamics in jet production with a global event shape . 2013. Probing nuclear dynamics in jet production with a global event shape . 88: 074020.
- Kang, Z. B., X. Liu, and S. Mantry. The 1-Jettiness DIS event shape: NNLL + NLO results. 2014. PHYSICAL REVIEW D. 90: 014041.
- Kang, Z. B., Y. Q. Ma, J. W. Qiu, and G. Sterman. Heavy Quarkonium Production at Collider Energies (I): Factorization and Evolution. 2014. PHYSICAL REVIEW D. 90: 034006.
- Kang, Z. B., Y. Q. Ma, and R. Venugopalan. Quarkonium production in high energy proton-nucleus collisions: CGC meets NRQCD. 2014. Journal of High Energy Physics. 01: 056.
- Kang, Z. B., and B. Xiao. Sivers asymmetry of Drell-Yan production in the small-x regime. 2013. Physical Review D. 87 (3): 034038.
- Vitev, I.. Transv. Invited presentation at Transverse momentum-weighted Sivers asymmetry in semi-inclusive deep inelastic scattering at next-to-leading order. (Newport News, VA, 6-10 May 2013).

Nuclear and Particle Futures

Postdoctoral Research and Development
Continuing Project

Boosting New Physics Discoveries with Jet Substructure

Christopher Lee
20130794PRD2

Introduction

The Standard Model (SM) of particle physics is the most precise and successful theory in the history of science, but it still cannot explain dark matter or the huge hierarchy of energy scales (from nuclear forces to gravity) found in nature. Much excitement today comes from predictions of new models of elementary particles that could help solve these mysteries and be detected at the Large Hadron Collider (LHC).

The LHC collides protons at high energies and records the resulting particles that are produced. The most common type of SM final state contains collimated streams of hadrons called jets, produced by radiation from high-energy quarks or gluons. On occasion, new, non-SM particles may be produced and decay into jets. A very difficult needle-in-the-haystack problem is to distinguish jets produced by new particles from the vastly larger number of jets produced by ordinary SM processes. This makes high-precision predictions of the SM jet background essential. Unfortunately, jet cross sections are among the least precisely understood due to the often prohibitively difficult nature of the calculations.

This research aims to vastly increase the precision of theoretical jet cross section predictions. We will develop strategies to characterize and probe the substructure of jets, which can serve as a discriminant between signal and background jets. We will apply our expertise in theoretical methods to resum the effects of infinitely many quarks and gluons radiated from jets to predict jet cross sections to high precision and accuracy. We will develop new methods to predict cross sections dependent on subject measures. We will thereby improve the theoretical input into Monte Carlo event generators that simulate large numbers of particles in high-energy collisions. All of these tools together will greatly advance our ability to find evidence of new physics at the LHC inside hadronic jets.

Benefit to National Security Missions

Two key missions of the DOE Office of Science in High-Energy and Nuclear Physics are 1) to improve our understanding of Quantum Chromodynamics (QCD), the theory of the strong interactions between quarks and gluons, constituents of all ordinary matter; and 2) to search for new particles and forces beyond the Standard Model that will explain the origin of matter, dark matter, and masses of elementary particles.

Understanding properties of jets of hadrons produced by energetic quarks and gluons are key to achieving these objectives. They reveal the behavior of QCD itself and contain evidence of new particles that decay to jets.

This project tackles problems at the forefront of QCD perturbation theory and strategies to search for signatures of new physics in the substructure of jets. Physically accurate predictions of jet cross sections require resumming arbitrarily many soft and collinear quark and gluon emissions in and from jets. We will develop and apply tools for resummation to achieve unprecedented precision in predicting jet cross sections for probing QCD and new physics at the Large Hadron Collider (LHC). In concert we will invent and develop new strategies for finding and characterizing jet substructure and interpreting those characteristics as signatures for new physics.

Historically, individuals hired for their expertise in this area have gone on to address a range of Laboratory challenges, including bio and energy security, thanks to their broad analytical skills.

Progress

Dr. Hornig has made progress on several topics of research under this PRD proposal in the past fiscal year.

Qjets ("Quantum" Jets)

Dr. Hornig has been developing a method that is designed to optimize the information one obtains when

making jet measurements at particle colliders such as the Large Hadron Collider (LHC). Traditional methods rely on a single interpretation of how quarks and gluons shower from one to many particles (and eventually hadrons) to form the jets we measure. By utilizing the fundamentally quantum mechanical nature of this process and allowing for multiple such interpretations, much can be gained. For one, the spread in the masses one obtains, a measure of the ambiguity of a jet's mass (dubbed the Qjet "volatility"), can be used to distinguish background Quantum Chromodynamics (QCD) jets from Standard Model and Beyond the Standard Model signal jets. In addition, the statistical nature of signal searches can be enhanced. Hornig's most recent work has been to understand the latter effect, which arises since assigning multiple interpretations to a jet done in a particular matter moves the QCD background to smaller mass, while only slightly distorting the signal distribution (negligible on the scale of a jet mass window typically used in experimental searches). A paper on this topic is currently being prepared for publication.

Qthrust

Thrust is an observable traditionally used to measure the degree of collimation of hadrons into jets in the final state of a collision. Recently Dr. Hornig has proposed a generalized version of thrust called "Qthrust," which incorporates the effect of a probabilistic assignment of particles to jets, reminiscent of the multiple interpretation algorithms associated with Qjet analyses. By understanding the differences between thrust and Qthrust analytically, one can hope to understand the ways in which probabilistic observables and deterministic (single interpretation) observables differ. In particular, Qthrust can be generalized to a jet and sub-jet observable in a way completely analogous to the way in which thrust has been generalized to N-jettiness and N-subjettiness, and the differences studied above can be directly applied to the corresponding (sub)-jet observables. Qthrust also provides an excellent arena to explore the structure of non-global logs with the hope of using probabilistic weighting to reduce their coefficients, allowing the precision community to begin to make strides in the difficult task of performing calculations relevant to field of jet substructure. Dr. Hornig has performed preliminary calculations in QCD perturbation theory to predict Qthrust cross sections and is on track to complete these calculations and report them in a publication in the coming fiscal year.

Future Work

- Complete perturbative calculations for "Qthrust" and evaluate its power as a prototype measure of subjet structure that can distinguish between Standard Model and new physics jets.

- Extend the tools of Soft Collinear Effective Theory (SCET) to make higher precision predictions for jet and subjet cross sections, especially their dependence on jet algorithm parameters such as jet size/radii R .

Conclusion

In this new, exciting era in particle physics, this project will play a crucial role in guiding what observables to measure at the Large Hadron Collider and how to interpret measurements for signals of new physics. We focus on probing the substructure of jets of hadrons to which new physics particles decay and which can be used to distinguish jets produced by known and by new physics. We will make simultaneous advances in search algorithms, theoretical predictions, and computational programs for jet cross sections that are all part of a comprehensive strategy for finding new physics using hadronic jets.

Publications

Ellis, S. D., A. Hornig, D. Krohn, and T. S. Roy. On Statistical Aspects of Qjets. *Journal of High-Energy Physics*.

Nuclear and Particle Futures

Postdoctoral Research and Development
Continuing Project

Investigating Properties of Quark-Gluon Plasma using Jets and Heavy Quark Production at RHIC

Xiaodong Jiang
20140665PRD2

Introduction

Jets measurements feature prominently in the current set of Large Hadron Collider (LHC) results. Measurements at Relativistic Heavy Ion Collider (RHIC) will provide insight into properties of the Quark Gluon Plasma (QGP) under different physical conditions than can be explored with the LHC alone. The 400 person PHENIX collaboration is planning to propose the construction of a new \$30M detector, sPHENIX, to DOE to provide a comprehensive set of jet measurements at RHIC and to prepare for the construction of an electron-ion collider (EIC). These physics goals are much beyond the original design capabilities of the PHENIX experiment which was designed two decades earlier. To achieve these measurements, this LDRD-PRD project proposes to spearhead the development and construction of a new RHIC detector needed to bring a world-class experimental jet physics program to LANL. The new detector is crucial to the full exploration and understanding of the Quark Gluon Plasma.

This LDRD-PRD project, aiming at a new research area of Heavy Ion Physics, namely using particle jet production as a probe to study the properties of Quark Gluon Plasma and leading the development of the future upgrade of the PHENIX detector, opens up a new research direction for LANL Nuclear Physics Program, which is very much beyond the capabilities of the current DOE-funded program. The current DOE funded Heavy Ion Physics program of P25 group has been focusing on higher energy muon detection through a magnetic spectrometer at the forward angle, and using a silicon vertex detector to separate primary muon from secondary decays. Our work in this project will go beyond this limitation by initiating a new set of detector system (sPHENIX) which is designed specifically for high energy jet measurement. Therefore, technical schemes and scientific goals of this LDRD-PRD project are beyond existing DOE funded non-LDRD projects.

Benefit to National Security Missions

This project is highly relevant LANL's Scientific Discovery and Innovation mission, in the area of Nuclear, Particle, Cosmology, and Astrophysics. Quantum Chromodynamics (QCD), the Standard Model theory governing the behavior of quarks and gluons, predicts that a new phase of matter is present in the relativistic collisions of large nuclei. Matter generated by these collisions is at such high temperature and density that quarks and gluons are no longer imprisoned in hadronic states, but are instead free to interact with one another directly, a state of matter known as Quark Gluon Plasma (QGP). The new phase of matter is being actively studied at hadron collider facilities such as the Relativistic Heavy Ion Collider (RHIC) at Brookhaven National Laboratory and the Large Hadron Collider (LHC) at CERN. Research work on the understanding of properties of Quark-Gluon Plasma will also contribute and lead to new resources of nuclear energy in the next generations.

Progress

This LDRD-PRD project, aiming at a new research area of Heavy Ion Physics, namely using particle jet production as a probe to study the properties of Quark Gluon Plasma and leading the development of the future upgrade of the PHENIX detector, opens up a new research direction for LANL Nuclear Physics Program, which is very much beyond the capabilities of the current DOE-funded program. Whereas, the current DOE funded Heavy Ion Physics program of P25 group has been focusing on higher energy muon detection through a magnetic spectrometer at the forward angle, and using a silicon vertex detector to separate primary muon from secondary decayed muons. Our work in this project will go beyond this limitation by initiating a new set of detector system (sPHENIX) which is designed specifically for high energy jet measurement. Therefore, technical schemes and scientific goals of this LDRD-PRD project are beyond existing DOE funded non-LDRD projects.

During the past six months, Mike has developed a jet simulation package based on PYTHIA event generator and anti-KT jet algorithm to study the jet sensitivity to the QGP properties, and further developed a direct-photon and jet separation method to improve the event kinematic reconstruction.

Mike presented his study at various working group meetings in PHENIX and also at major international conferences. Representing the PHENIX collaboration, Mike successfully defended the sPHENIX proposal at various review, including the latest BNL Directors Review. He has presented the jet physics study at the DOE sPHENIX Science Review that is scheduled July 1-2, 2014.

In addition, Mike also led the efforts in establishing the physics program in Forward sPHENIX jet production for future p+p and p+A collisions. A white-paper of Forward sPHENIX, with many major contributions from Mike, has been submitted to BNL's management in May 2014.

Future Work

This LDRD-PRD project, aiming at a new research area of Heavy Ion Physics, namely using particle jet production as a probe to study the properties of Quark-Gluon Plasma and leading the development of the future upgrade of the PHENIX detector, opens up a new research direction for LANL Nuclear Physics Program, which is very much beyond the capabilities of the current DOE-funded program. Whereas, the current DOE funded Heavy Ion Physics program of P25 group has been focusing on higher energy muon detection through a magnetic spectrometer at the forward angle, and using a silicon vertex detector to separate primary muon from secondary decayed muons. Our work in this project will go beyond this limitation by initiating a new set of detector system (sPHENIX) which is designed specifically for high energy jet measurement. Therefore, technical schemes and scientific goals of this LDRD-PRD project are beyond existing DOE funded non-LDRD projects.

At the same time, during the development of the sPHENIX design, PHENIX experiment will continue to take interesting data in 2014 and 2015. As a physics working group convener in PHENIX for hard scattering physics, Mike will also direct ongoing analysis and publication in the new directions on the topics such as modified jet fragmentation, heavy quark energy loss, and quarkonia production. This part of the research effort is not on the original PHENIX experiment's physics plan approved by DOE, therefore, Mike's research work will push the physics frontier of PHENIX experiment much beyond the DOE funded projects.

sPHENIX detector at RHIC: leadership of the detector

research and development needed for the construction of a jet-focused experiment at Relativistic Heavy Ion Collider (RHIC) covering both mid and forward rapidity in preparation for an Electron-Ion Collider (EIC) detector.

Conclusion

A key piece of physics to obtain in this data is the energy loss of massive quarks in the Quark Gluon Plasma (QGP) and so Mike will take a leadership role in the first direct analysis of heavy quarks at forward rapidity using the Forward Vertex (FVTX) detector, a LANL led DOE project, from the heavy ion data to be collected in 2014. This work presents a pivotal test of the models describing the interaction of fast moving quarks with the QGP so will prepare the field for the suite of measurements to come with the sPHENIX detector.

Publications

Adare, , Afanasiev, Aidala, N. N. Ajitanand, Akiba, Akimoto, Al-Bataineh, Al-Ta'ani, Alexander, Angerami, Aoki, Apadula, Aphecetche, Aramaki, Armendariz, S. H. Aronson, Asai, Asano, E. C. Aschenauer, E. T. Atomssa, et.al. Medium Modification of Jet Fragmentation in Au plus Au Collisions at $\sqrt{s_{NN}}=200$ GeV Measured in Direct Photon-Hadron Correlations. 2013. PHYSICAL REVIEW LETTERS. 111 (3).

Adare, , Afanasiev, Aidala, N. N. Ajitanand, Akiba, Akimoto, Al-Bataineh, Al-Ta'ani, Alexander, K. R. Andrews, et.al. Gamma ($1S+2S+3S$) production in d plus Au and p plus p collisions at $\sqrt{s_{NN}}=200$ GeV and cold-nuclear-matter effects. 2013. PHYSICAL REVIEW C. 87 (4).

Adare, , Afanasiev, Aidala, N. N. Ajitanand, Akiba, Akimoto, Al-Ta'ani, Alexander, Angerami, Aoki, Apadula, Aramaki, Asano, E. C. Aschenauer, et.al. Evolution of $\pi(0)$ Suppression in Au plus Au Collisions from $\sqrt{s_{NN}}=39$ to 200 GeV. 2012. PHYSICAL REVIEW LETTERS. 109 (15).

Adare, , Afanasiev, Aidala, N. N. Ajitanand, Akiba, Al-Bataineh, Alexander, Al-Jamel, Angerami, Aoki, Apadula, Aphecetche, Aramaki, Armendariz, S. H. Aronson, et.al. Nuclear modification factors of ϕ mesons in d plus Au, Cu plus Cu, and Au plus Au collisions at $\sqrt{s_{NN}}=200$ GeV. 2011. PHYSICAL REVIEW C. 83 (2).

Adare, , Afanasiev, Aidala, N. N. Ajitanand, Akiba, Al-Bataineh, Alexander, Al-Jamel, Aoki, Aphecetche, Armendariz, S. H. Aronson, Asai, E. T. Atomssa, Averbeck, T. C. Awes, et.al. Enhanced Production of Direct Photons in Au plus Au Collisions at $\sqrt{s_{NN}}=200$ GeV and Implications for the Initial Temperature. 2010. PHYSICAL REVIEW LETTERS. 104 (13).

Adare, , Afanasiev, Aidala, N. N. Ajitanand, Akiba, Al-Bataineh, Alexander, Al-Ta'ani, Angerami, Aoki, Apadula,

- Aphécetche, Aramaki, Asai, E. T. Atomssa, et.al. Measurement of transverse single-spin asymmetries for J/ψ production in polarized p plus p collisions at root $s=200$ GeV. 2010. PHYSICAL REVIEW D. 82 (11).
- Adare, , Afanasiev, Aidala, N. N. Ajitanand, Akiba, Al-Bataineh, Alexander, Angerami, Aoki, Apadula, Aphécetche, Aramaki, Asai, E. T. Atomssa, Averbeck, T. C. Awes, et.al. Heavy-flavor electron-muon correlations in p plus p and d plus Au collisions at root $s(\text{NN})=200$ GeV. 2014. PHYSICAL REVIEW C. 89 (3).
- Adare, , Afanasiev, Aidala, N. N. Ajitanand, Akiba, Al-Bataineh, Alexander, Angerami, Aoki, Apadula, Aphécetche, Aramaki, Asai, E. T. Atomssa, Averbeck, T. C. Awes, et.al. Measurement of transverse-single-spin asymmetries for midrapidity and forward-rapidity production of hadrons in polarized p plus p collisions at root $s=200$ and 62.4 GeV. 2014. PHYSICAL REVIEW D. 90 (1).
- Adare, , Afanasiev, Aidala, N. N. Ajitanand, Akiba, Al-Bataineh, Alexander, Angerami, Aoki, Apadula, Aramaki, E. T. Atomssa, Averbeck, T. C. Awes, et.al. Spectra and ratios of identified particles in Au plus Au and d plus Au collisions at root $s(\text{NN})=200$ GeV. 2013. PHYSICAL REVIEW C. 88 (2).
- Adare, , Afanasiev, Aidala, N. N. Ajitanand, Akiba, Al-Bataineh, Alexander, Aoki, Apadula, Aphécetche, Armendariz, S. H. Aronson, Asai, E. T. Atomssa, Averbeck, T. C. Awes, et.al. System-size dependence of open-heavy-flavor production in nucleus-nucleus collisions at root $s(\text{NN})=200$ GeV. 2014. PHYSICAL REVIEW C. 90 (3).
- Adare, , Afanasiev, Aidala, N. N. Ajitanand, Akiba, Al-Bataineh, Alexander, Aoki, Aphécetche, Aramaki, Asai, E. T. Atomssa, Averbeck, T. C. Awes, et.al. Transverse momentum dependence of eta meson suppression in Au plus Au collisions at root $s(\text{NN})=200$ GeV. 2010. PHYSICAL REVIEW C. 82 (1).
- Adare, , Afanasiev, Aidala, N. N. Ajitanand, Akiba, Al-Bataineh, Alexander, Aoki, Aphécetche, Armendariz, S. H. Aronson, Asai, E. T. Atomssa, Averbeck, T. C. Awes, et.al. Nuclear-modification factor for open-heavy-flavor production at forward rapidity in Cu plus Cu collisions at root $s(\text{NN})=200$ GeV. 2012. PHYSICAL REVIEW C. 86 (2).
- Adare, , Afanasiev, Aidala, N. N. Ajitanand, Akiba, Al-Bataineh, Alexander, Aoki, Aramaki, E. T. Atomssa, Averbeck, T. C. Awes, et.al. Azimuthal Anisotropy of $\pi(0)$ Production in Au plus Au Collisions at root $s(\text{NN})=200$ GeV: Path-Length Dependence of Jet Quenching and the Role of Initial Geometry. 2010. PHYSICAL REVIEW LETTERS. 105 (14).
- Adare, , Afanasiev, Aidala, N. N. Ajitanand, Akiba, Al-Bataineh, Alexander, Aoki, Aramaki, E. T. Atomssa, Averbeck, T. C. Awes, et.al. Azimuthal anisotropy of $\pi(0)$ and eta mesons in Au plus Au collisions at root $s(\text{NN})=200$ GeV. 2013. PHYSICAL REVIEW C. 88 (6).
- Adare, , Afanasiev, Aidala, N. N. Ajitanand, Akiba, Al-Bataineh, Alexander, Aoki, Aramaki, E. T. Atomssa, Averbeck, T. C. Awes, et.al. Observation of Direct-Photon Collective Flow in Au plus Au Collisions at root $s(\text{NN})=200$ GeV. 2012. PHYSICAL REVIEW LETTERS. 109 (12).
- Adare, , Afanasiev, Aidala, N. N. Ajitanand, Akiba, Al-Bataineh, Alexander, Aoki, Aramaki, E. T. Atomssa, Averbeck, T. C. Awes, et.al. Neutral pion production with respect to centrality and reaction plane in Au plus Au collisions at root $s(\text{NN})=200$ GeV. 2013. PHYSICAL REVIEW C. 87 (3).
- Adare, , Aidala, N. N. Ajitanand, Akiba, Akimoto, Al-Bataineh, Al-Ta'ani, Alexander, K. R. Andrews, Angerami, Aoki, Apadula, Appelt, Aramaki, Armendariz, E. C. Aschenauer, E. T. Atomssa, Averbeck, T. C. Awes, et.al. Cold-Nuclear-Matter Effects on Heavy-Quark Production at Forward and Backward Rapidity in d + Au Collisions at root $s(\text{NN}) = \text{GeV}$. 2014. PHYSICAL REVIEW LETTERS. 112 (25).
- Adare, , Aidala, N. N. Ajitanand, Akiba, Akimoto, Al-Ta'ani, Alexander, Alfred, K. R. Andrews, Angerami, Aoki, Apadula, Appelt, Aramaki, Armendariz, Asano, E. C. Aschenauer, E. T. Atomssa, T. C. Awes, et.al. Low-mass vector-meson production at forward rapidity in p plus p collisions at root $s=200$ GeV. 2014. PHYSICAL REVIEW D. 90 (5).
- Adare, , Aidala, N. N. Ajitanand, Akiba, Akimoto, Al-Ta'ani, Alexander, K. R. Andrews, Angerami, Aoki, Apadula, Appelt, Aramaki, Armendariz, E. C. Aschenauer, T. C. Awes, et.al. Inclusive double-helicity asymmetries in neutral-pion and eta-meson production in $\langle(p)$ over right arrow $\rangle + \langle(p)$ over right arrow \rangle collisions at root $s=200$ GeV. 2014. PHYSICAL REVIEW D. 90 (1).
- Adare, , Aidala, N. N. Ajitanand, Akiba, Al-Bataineh, Alexander, Angerami, Aoki, Apadula, Aramaki, E. T. Atomssa, Averbeck, T. C. Awes, et.al. Centrality categorization $R_p(d)+A$ in high-energy collisions. 2014. PHYSICAL REVIEW C. 90 (3).
- Adare, , Aidala, N. N. Ajitanand, Akiba, Al-Bataineh, Alexander, Angerami, Aoki, Apadula, Aramaki, E. T. Atomssa, Averbeck, T. C. Awes, et.al. Nuclear Modification of ψ' , $\chi(c)$, and J/ψ Production in d plus Au Collisions at root $s(\text{NN})=200$ GeV. 2013. PHYSICAL REVIEW LETTERS. 111 (20).
- Adare, , Aidala, N. N. Ajitanand, Akiba, Al-Bataineh, Alexander, Angerami, Aoki, Apadula, Aramaki, E. T. Atomssa,

Averbeck, T. C. Awes, et.al. Quadrupole Anisotropy in Dihadron Azimuthal Correlations in Central d plus Au Collisions at root $s(NN)=200$ GeV. 2013. PHYSICAL REVIEW LETTERS. 111 (21).

Adare, , S. S. Adler, Afanasiev, Aidala, N. N. Ajitanand, Aki-ba, Al-Bataineh, Al-Jamel, Alexander, Angerami, Aoki, Apadula, Aphecetche, Aramaki, Armendariz, S. H. Aronson, Asai, E. T. Atomssa, Averbeck, T. C. Awes, et.al. Direct photon production in d+Au collisions at root $s(NN)=200$ GeV. 2013. PHYSICAL REVIEW C. 87 (5).

Adare, , S. S. Adler, Afanasiev, Aidala, N. N. Ajitanand, Aki-ba, Al-Bataineh, Alexander, Al-Jamel, Aoki, Aphecetche, Armendariz, S. H. Aronson, Asai, E. T. Atomssa, Averbeck, T. C. Awes, et.al. Cold nuclear matter effects on J/psi production as constrained by deuteron-gold measurements at root $s(NN) = 200$ GeV (vol 77, 024912, 2008). 2009. PHYSICAL REVIEW C. 79 (5).

Adare, , S. S. Adler, Afanasiev, Aidala, N. N. Ajitanand, Aki-ba, Al-Bataineh, Alexander, Al-Jamel, Aoki, Aphecetche, Armendariz, S. H. Aronson, Asai, E. T. Atomssa, Averbeck, T. C. Awes, et.al. Charged hadron multiplicity fluctuations in Au+Au and Cu+Cu collisions from root $S-NN = 22.5$ to 200 GeV. 2008. PHYSICAL REVIEW C. 78 (4).

McCumber, M. P.. Back-to-back pair suppression at large transverse momentum in root $s(NN)=200$ GeV Au + Au collisions at PHENIX. 2011. NUCLEAR PHYSICS A. 855 (1): 408.

McCumber, M. P.. High $p(T)$: Energy Loss Physics at PHENIX. 2013. NUCLEAR PHYSICS A. 904: 154C.

Nuclear and Particle Futures

Postdoctoral Research and Development
Continuing Project

New Tools to Probe Matter with an Electron-Ion Collider

Christopher Lee
20140671PRD2

Introduction

High-energy collisions are a powerful tool to discover fundamental particles and laws of nature. The focus of US nuclear physics is now turning to a new Electron Ion Collider (EIC), where nuclei are to be probed more extensively than ever. Crucial measurements there will include precision determination of the strong coupling α_s and nuclear parton distributions that affect nearly all predictions at other colliders. Many final states in such colliders include collimated bunches of strongly interacting particles, called jets. Predicting precisely the properties of jets is indispensable to search for fingerprints of new physics or to probe the structure of nuclei. In the last decade, soft-collinear effective theory (SCET) has become a powerful theoretical tool for precise predictions for jet production. Successful applications of SCET include α_s determination to incredible precision $< 1\%$ using data from $e+e-$ collisions. However, this value is in tension with numerical lattice results by more than 3 standard deviations, threatening the predictive power of the Standard Model and urgently demands resolution.

Our research will develop the tools of SCET to push the frontier of precision jet physics at the future EIC. Currently theory uncertainties in jet production remain well behind experimental uncertainties. In order to maximize the potential of the new EIC, a concomitant effort to improve accuracy of theoretical predictions is essential. Our preliminary work on 2-jet production in deep inelastic scattering (DIS) has opened a new avenue in this direction, leading to factorization theorems for DIS jet cross sections valid to all orders in α_s which can be systematically computed to any desired accuracy. We will use this theoretical power to compute EIC jet cross sections to the highest precision to date, allowing us to use future EIC data to resolve the existing discrepancies in determining α_s .

Benefit to National Security Missions

The proposed research is directly aligned with LANL and national priorities in physics at a future electron-ion collider (EIC), a machine that would probe the structure of the proton and the nature of the strong interaction in unprecedented detail. The proton is a ubiquitous component of all ordinary matter in the universe, and the strong interaction is what binds the constituents of the proton (quarks and gluons) together and protons and neutrons to each other in nuclei. Understanding protons and the strong interaction is key to our fundamental understanding of Nature. Central to this proposal are development and application of Soft Collinear Effective Theory (SCET) to provide the high precision predictions necessary to interpret the unprecedentedly detailed data on nucleon structure that will come from EIC. The proposed calculations will allow us to use EIC data to resolve current disagreements in measurements of the strong coupling, a fundamental constant affecting all studies of nuclear matter (e.g. LHC, RHIC). EIC physics and SCET are high priorities under the LANL Nuclear & Particle Futures Pillar, under the research thrust "Advancing our understanding of QCD and the fundamental properties of nuclear matter." The 2007 NSAC Long-Range Plan for DOE identifies this research as highest priority: "The EIC embodies the vision of our field for reaching the next QCD frontier," further emphasizing, "It is essential that theoretical support for EIC-related physics is maintained at a healthy level." The proposed research will strengthen LANL and US leadership in this exciting international endeavor.

Progress

As of this report, the postdoc is awaiting to be hired.

Future Work

We plan to predict cross sections in Deep Inelastic Scattering (DIS) of electrons and protons, differential in one of several event shape variables known as "N-jettiness."

These measure the degree of collimation of final state hadrons into N energetic “jets” in addition to radiation along the beam direction.

In the next fiscal year, we will predict DIS 1-jettiness cross sections to unprecedented next-to-next-to-next-to-leading logarithmic (NNLL) accuracy in resummed perturbation theory in Quantum Chromodynamics (QCD).

We will establish the factorization theorem for multi-jet cross sections with $N > 1$. We will compute the first set of fixed-order perturbative corrections and resum the first sets of large logarithms that affect these cross sections in resummed perturbation theory.

We will explore the degree of universality of the leading nonperturbative corrections to 1-jettiness cross sections. We will explore the nonperturbative corrections to multi-jet cross sections.

We will begin to determine the best strategy to apply these theoretical predictions to the extraction of the strong coupling at an Electron Ion Collider (EIC).

Conclusion

The goals of this project include predicting 2-jet cross sections at EIC to the highest precision to date, and so reduce theoretical uncertainty by up to an order of magnitude, and then to predict multi-jet production in EIC collisions, which exhibit even greater sensitivity to α_s . These results will make possible the most precise extractions of α_s from DIS data and shed light on the current tension among different methods of extraction. α_s is a fundamental constant of nature and affects all predictions at colliders involving the strong interaction.

Publications

Kang, D., C. Lee, and I. W. Stewart. Analytic Calculation of 1-Jettiness in DIS at $O(\alpha_s)$. To appear in Journal of High-Energy Physics.

Nuclear and Particle Futures

Postdoctoral Research and Development
Continuing Project

Electric Dipole Moments of Hadrons from Lattice Quantum ChromoDynamics

Vincenzo Cirigliano

20140673PRD2

Introduction

The observation of an Electric Dipole Moment (EDM) in the next generation of experiments will be a clear signal of new physics. However, interpreting the results of EDM experiments to identify the mechanism of CP-violation is a non-trivial task (CP = charge conjugation and parity is the symmetry that relates matter to antimatter). The mechanism of CP-violation is best formulated at the level of elementary constituents, such as quarks and gluons. Relating these CP-violating interactions of quarks and gluons to the CP-violating couplings of their bound states such as pions and neutrons, and to the observable EDMs requires dealing with the strong interaction (described by Quantum ChromoDynamics, QCD) in the non-perturbative regime.

We will determine pion-nucleon CP-violating couplings originating from new physics using lattice QCD, the only first-principle and improvable approach to QCD in the low-energy regime. These couplings are particularly important because, besides giving sizable contributions to the neutron EDM, they mediate long range CP-violating interactions between neutrons and protons and dominate the EDMs of light nuclei. A direct calculation of the CP-violating couplings is computationally very demanding. The key observation at the basis of this project is that the symmetries of QCD simplify the task of calculating these couplings by relating them to CP-conserving corrections to pion, neutron, and proton masses.

One can thus use lattice QCD to compute masses in presence of new physics perturbations, and then rely on chiral symmetry to determine CP-violating couplings. Specifically, we will compute the shift in the pion and neutron mass and mass splittings induced by the dominant CP-conserving quark-gluon operators induced by physics beyond the Standard Model. Our calculation will reach a precision of 20-30%, a considerable improvement compared to the current order-of-magnitude uncertainties.

Benefit to National Security Missions

The experimental search for Electric Dipole Moments of the neutron and light nuclei is a recognized priority of the DOE/SC Office of Nuclear Physics. This theoretical project will elucidate the relationship between the experimental findings and the underlying interactions that break the so-called CP-symmetry, i.e. the symmetry that interchanges matter and antimatter. The relation between experimental results and underlying sources of CP-violation is characterized by a handful of coefficients (matrix elements), that are currently uncertain at the order-of magnitude level. Our theoretical calculations will reduce the current uncertainty to the level of 20-30%, thus greatly sharpening the interpretation of current experimental searches, in which DOE/SC is making considerable investments.

Progress

As of this report, the postdoc is awaiting to be hired.

Future Work

In this project we will focus on the two dominant quark-level sources of CP violation (CP = charge conjugation and parity is the symmetry that relates matter to antimatter) beyond the Standard Model, namely the so-called quark electric dipole moment, the quark chromo-electric dipole moment operators, and the gluon chromo-electric dipole moment. We expect to achieve the following results:

- On the analytic side, we will perform the chiral symmetry transformation that relates these sources of CP-violation to corrections to the pion, neutron, and proton mass. This task will serve as a basis for all future computational efforts.
- On the computational side of the project, in the first year we will compute the correction to masses induced by one of the three dominant sources of CP-violation, namely the quark electric dipole moment

operator. The technical challenge here involves extracting a non-zero signal from the neutron and proton correlation functions. This requires not only accumulating high statistics in the numerical Monte Carlo sampling, but also addressing all the systematics related to discretizing space-time on a finite lattice.

Conclusion

In the next few years, several experiments with strong LANL involvement will significantly improve the sensitivity to Electric Dipole Moments (EDM) of the neutron and nuclei, and, hopefully, discover new physics. Our results will be essential in order to relate the experimental results to the underlying sources of charge conjugation and parity (CP) symmetry breaking (CP is the symmetry that relates matter and antimatter). This will allow a more robust interpretation of EDM signals, and a more direct connection to BSM models, with impacts in the fields of nuclear physics, particle physics, and cosmology.

Nuclear and Particle Futures

Postdoctoral Research and Development
Continuing Project

Multi-wavelength Studies of Explosive Astrophysical Transients

Przemyslaw R. Wozniak
20140674PRD3

Introduction

High energy transients producing photons in the GeV-TeV energy range represent a largely unexplored phase space in transient phenomena. To study these extreme phenomena one needs a sensitive (large) detector, wide field-of-view and near continuous operations such as the High Altitude Water Cherenkov (HAWC) observatory. Astrophysical transients such as gamma-ray Bursts (GRBs), Active Galactic Nuclei (AGN), or high-mass X-ray binaries can emit across the entire electromagnetic spectrum from radio to high-energy gamma rays. Rapid multi-wavelength observations are key to understanding the underlying mechanisms of particle acceleration and localizing emission regions. Swift is the only X-ray observatory that can respond quickly enough to HAWC transients and cover the HAWC error box (1 deg) to observe any contemporaneous lower-energy counterparts before they fade away. RAPTOR telescopes at LANL are uniquely equipped to rapidly (< 6 sec) cover the HAWC error box in the optical (2 eV) and catch the associated afterglow emission. Our approach is to automatically alert the most significant transients detected by RAPTOR, Swift, or HAWC, and immediately follow them up. For this purpose we will utilize our approved Swift Guest Investigator Target of Opportunity program and the RAPTOR network. The fast slewing capability of RAPTOR will enable follow-up of sub-threshold triggers from HAWC. In the case of a detection, we will use Swift to perform additional observations in X-rays. To accomplish these goals we will develop new software and the instrument networking framework for real-time correlations of data arriving simultaneously from multiple instruments. Another important advance will be new transient search and classification algorithms for massive time-domain sky surveys such as the Palomar Transient Factory (PTF) and the Large Synoptic Survey Telescope (LSST). In the future, this technology will enable similar studies on much larger data sets.

Benefit to National Security Missions

Tilan Ukwatta will perform research to establish the origin of very high-energy photons in γ -ray bursts and explain the broad-band spectra of explosive astrophysical transients. To accomplish these goals, he will cross-correlate real-time data streams from the RAPTOR telescopes at LANL with data from the Swift satellite and HAWC (High Altitude Water Cherenkov) detector. For this purpose Tilan will utilize and extend LANL's unique capabilities in the area of telescope networking and continuous sky monitoring. He will also develop new transient search and classification algorithms and software for massive time-domain sky surveys.

This research is well aligned with the long-term vision for Global Security and Threat Identification and Response to develop cutting edge Information Science and Technology capability for national security. The proposed work benefits two out of six focus areas of the Strategic Outcomes Office within PADGS: Large Data to Decisions and Persistent Surveillance.

Progress

As of this report, the postdoc is awaiting to be hired.

Future Work

The main first year goal for the project is to develop a preliminary version of the framework to cross-correlate transient events from RAPTOR, Swift, and HAWC. Triggering criteria for Target of Opportunity (ToO) observations of HAWC events must be designed, coded, and integrated with event messaging and database systems. New data ingest and event translation routines must be developed for anticipated transient events from all three instruments. In the first year we plan to begin initial cross-correlations of data streams from RAPTOR, Swift, and HAWC to provide enough triggers for executing 6 ToO Swift observations.

Another first year goal is to begin the work on iterative

probabilistic classification of transients based on heterogeneous data such as time-resolved multi-color photometry, spectra, and possible X-ray/gamma-ray detections. We will develop a mathematical toolbox based on Bayesian networks that can go beyond classification problems constrained to a major class of transients such as Supernovae and instead handle a diverse set of transients. This effort will span multiple years.

Finally, we will model and interpret interesting transients observed over the course of the year. We will fit the observed light curves and time-resolved spectra with blast wave models to identify the relevant emission components and constrain their parameters. Using the relative strength and timing of those components we will constrain possible emission sites and shock propagation scenarios.

We will also study HAWC's sensitivity to hypothetical TeV transients caused by Primordial Black Holes (PBH) that evaporate by Hawking radiation. Once we have a firm handle on the predicted signature, we will develop the selection and follow-up triggering criteria to include PBH events in future searches.

Conclusion

The overarching goal of this project is to perform state of the art real-time searches and joined follow-up campaigns of flaring GeV-TeV emitters using RAPTOR, Swift and HAWC instruments. For this purpose we must develop new software tools and the instrument networking framework for real-time cross-correlations of heterogeneous data streams. Our joined RAPTOR/Swift transient localizations and HAWC observations are likely to deliver the first ground based detection of a GRB. Combined with follow-up studies and distance measurements, these observations will cover photon energies from eV to TeV, providing strong constraints on emission mechanisms that power these extraordinary objects.

CP Violation in Scenarios Beyond the Standard Model

Vincenzo Cirigliano
20110583PRD2

Abstract

In this project we have explored the role of tau-lepton decays into hadrons (=strongly interacting particles) in probing physics beyond the Standard Model of elementary particles and interactions. Technical highlights of our analysis include: (i) A more precise extraction of the quark-mixing angle V_{us} from tau decays, which in time will lead to more stringent tests of the Standard Model using weak interactions. (ii) A study of non-standard flavor-violating interactions of the newly discovered Higgs particle, comparing the physics reach of hadronic tau decays versus the Large Hadron Collider.

Background and Research Objectives

While extremely successful, the Standard Model (SM) of elementary particles is incomplete. New phenomena are expected to emerge both at high energy colliders and in decays of relatively light particles produced at low-energy colliders, such as the tau lepton (with mass less than twice the proton mass). Among tau decays, the decays into strongly interacting particles (such as pions and kaon mesons) offer a rich playground to probe non-standard interactions arising from physics beyond the Standard Model (BSM). When dealing with strongly-interacting decay products, the primary task is to obtain reliable calculations of the energy spectra and total decay rates. This problem cannot be solved by making an expansion in small coupling constants or other parameters, but requires non-perturbative quantum field theory techniques, known technically as “dispersion relations”. In this project we have set up the tools to use hadronic tau decays as a reliable probe of new physics, and with these tools in hand have explored a few classes of new physics models, with emphasis on (i) non-standard couplings of the newly discovered Higgs boson; (ii) constraints on the masses and couplings of new hypothetical particles called Leptoquarks, that mediate new interactions between the known building blocks of matter, leptons and quarks.

Scientific Approach and Accomplishments

A tau lepton is essentially a heavier brother of the familiar electron encountered in all atoms. The tau is however quite heavy (~ 1.8 times heavier than the proton), and so it can disintegrate into a neutrino and strongly interacting particles such as 2 (or 3) pions, 2 (or 3) kaons, or a pion and a kaon, etc. Within the SM a well defined pattern of decay rates arises, since the particle that mediates the decay is the known W meson. Beyond the SM, a host of new particles can mediate tau decays. However, despite the multiplicity of possible mediators, only a finite number of non-perturbative decay amplitudes, called form factors, need to be computed. When studying disintegrations with two mesons in the final state, one needs to compute the “vector” form factor and a number of “scalar” form factors associated to the coupling of light and heavy quarks to the new mediators such as the Higgs particle, see Figure 1 for an illustration.

In this project we have computed state-of-the-art vector form factors for the kaon-pion [1] and pion-pion [2] final states using rigorous techniques that rely on dispersion relations. Moreover, we have for the first time computed the complete set of scalar form factors to both pion-pion and kaon-kaon final states [2]. These advances in the computation of the form factors have enabled us to enhance the role of tau decays as probes of new physics. The main highlights are:

- We have improved the prediction for the decay $\tau \rightarrow \text{pion kaon neutrino}$, thus enhancing the precision with which one extracts the quark mixing angle V_{us} , [1].
- We have studied in detail the implications of Higgs-mediated rare tau decays [2]. This allows us to put constraints on non-standard couplings of the recently discovered Higgs boson and a class of other Higgs bosons arising in many extensions of the SM (including the non-standard Higgs bosons that are “odd”

under CP symmetry, where C is charge conjugation and P is the space reflection transformation). As an example, we are able to precisely predict the spectrum for the rare decay $\tau \rightarrow \mu \pi \pi$ induced by non-standard interactions of the Higgs (Figure 2).

- We have set up the analysis of leptoquark-mediated tau decays, which we are finalizing and should lead to a publication in the next few months.

Impact on National Missions

Probing physics beyond the SM is one of the declared mission goals for DOE Office of Nuclear Physics and Office of High Energy Physics. Our research has contributed to advance the interpretation of experiments such as BaBar at SLAC (Stanford) and Belle at KEK (Japan), both funded by the US DOE.

Figure 1. Feynman diagram showing the Higgs-mediated rare decay $\tau \rightarrow \mu$ quark-antiquark. The quark-antiquark pair converts in to a pair of pion mesons through the so-called scalar form factor, a non-perturbative amplitude that we have compute using dispersion relations.

Figure 2. Predicted distribution of events for the rare decay $\tau \rightarrow \mu$ pion-pion, versus the energy of the di-pion final state. The two peaks are associated with low-energy resonances that have the same quantum numbers of the photon and the Higgs.

References

1. Antonelli, M., V. Cirigliano, A. Lusiani, and E. Passemar. Predicting the tau strange branching ratios and implications for V_{us} . To appear in JHEP (Journal of High Energy Physics).
2. Celis, A., V. Cirigliano, and E. Passemar. Lepton flavor violation in the Higgs sector and the role of hadronic tau-lepton decays. To appear in Physical Review D.

Publications

Antonelli, M., V. Cirigliano, A. Lusiani, and E. Passemar. Predicting the tau strange branching ratios and implications for V_{us} . To appear in JHEP (Journal of High Energy Physics), 2013 .

Celis, A., V. Cirigliano, and E. Passemar. Lepton flavor violation in the Higgs sector and the role of hadronic tau-lepton decays. To appear in Physical Review D .

Colangelo, G., E. Passemar, and P. Stoffer. A Dispersive Treatment of K_{l4} Decays. 2013. In MESON2012 - 12th International Workshop on Meson Production, Properties and Interaction . (Krakow, Poland, 31 May - 5 June 2012). , p. 1. Les Ulis: EPJ Web of Conferences.

Colangelo, G., S. Lanz, H. Leutwyler, and E. Passemar. Determination of the light quark masses from $\eta \rightarrow 3\pi$.

2011. In The 2011 Europhysics Conference on High Energy Physics-HEP 2011. (Grenoble, Rhone-Alpes France, 21-27 July 2011). , p. 304. Sissa: Proceedings of Science.

Nuclear and Particle Futures

Postdoctoral Research and Development
Final Report

Influence of Velocity Shear on Turbulent Magnetic Reconnection at the Earth's Magnetopause

William S. Daughton
20110750PRD3

Abstract

The solar wind is a hot ionized gas (or plasma) that is continually streaming outward from the Sun. When this stream of charged particles interacts with the magnetic field of the Earth, it produces the magnetosphere – a protective magnetic bubble that partially shields our planet from energetic particles. The dynamics of the magnetosphere has long been of interest both scientifically and for practical impacts to modern infrastructure, including damage to satellites, interruption of GPS service, and power grid failures. The focus of this Director's fellowship project was to examine the natural processes that can give rise to leaks in this shield using large-scale computer simulations. To accomplish this objective, this project employed a LANL developed computer code that treats the physics at the most basic level. Using some of the largest supercomputers in the country, we performed the first three-dimensional simulations to study the plasma physics of these processes, and to predict the mixing of energetic particles into the magnetosphere. These efforts lead to a number of new scientific discoveries that have been compared against spacecraft observations and documented in scientific journal articles, as well as a follow-on project funded by NASA.

Background and Research Objectives

The penetration of energetic solar wind plasma into the Earth's magnetosphere depends critically on a thin boundary layer around the protective bubble called the magnetopause. Instabilities and turbulence can develop in this layer due to rapid changes in both the magnetic field and plasma velocity. The rapid change in the magnetic field drives a process known as magnetic reconnection, which can change how field lines are connected in the plasma and release energy stored in these fields. On the other hand, the strong velocity shear in these boundary layers can drive an instability known as Kelvin-Helmholtz (KH), which leads to swirls and vortices in the flow. Both of these processes give rise to "leaks" in the protective bubble, allowing energetic particles to

enter the magnetosphere. While both of these processes are interesting and important, they are usually studied separately. However, in the real magnetosphere they may often occur together and influence each other in complex ways. For example, as the vortices rotate in a plasma they produce intense layers of electrical current around their perimeter which maybe unstable to magnetic reconnection. This so-called vortex-induced reconnection has been studied previously using approximate two-dimensional models [1], but many uncertainties remained. The full nature of this complex coupling can only be described using three-dimensional computer simulations that use the most basic "kinetic" description of the physics. Until recently, this was simply too difficult for any computer simulation. The main research objective of this project was to exploit the newest generation of petascale computers to perform the first three-dimensional simulations of these boundary layers and to quantify the complex coupling between magnetic reconnection and the Kelvin-Helmholtz instability. Furthermore, our secondary objective was to look for observational signatures of these physical processes that can be tested with spacecraft measurements.

Scientific Approach and Accomplishments

This project performed the first 3D kinetic simulations of vortex-induced reconnection for initial conditions relevant to the Earth's magnetopause boundary layer. The preliminary simulations were performed with the LANL developed VPIC code using the Mustang computer at Los Alamos. Our largest three-dimensional simulations were performed using 100,000 cores of the Jaguar computer at Oak Ridge National Laboratory. In current layers with strong Alfvénic velocity shear, the generation of vortices from the Kelvin-Helmholtz instability can drive magnetic reconnection even in broader current sheets by locally compressing these layers as the vortices develop. Previous two-dimensional (2D) fully kinetic simulations of this vortex-induced reconnection process has demonstrated the copious formation of magnetic islands in regions of

strongly compressed current between the vortices [1]. Our new three-dimensional (3D) kinetic simulations demonstrate that the compressed current sheets give rise to magnetic flux ropes over a range of oblique angles and along the entire extent of the compressed current layer around the periphery of the vortex [2]. The formation of these 3D flux ropes gives rise to chaotic mixing of field lines and particles across the layer as illustrated in Figure 1. As the dynamics proceed further, these flux ropes propagate with the shear flow and eventually merge with the vortex. Over longer time scales, this basic scenario is repeated as the vortices drive new compressed current sheets and additional particle mixing. In the final stage, the vortices undergo a merging process that drives new compressed current sheets and flux ropes. Based on these simulations, a simple model was developed that predicts the size of these flux ropes relative to their parent vortex [2]. Furthermore, we were able to demonstrate that the relative sizes as well as the structure of the profiles across the vortex are in reasonable agreement with THEMIS observations at the Earth's low-latitude magnetopause as illustrated in Figure 2. To proceed further, a series of simulations were performed over a range of parameters relevant to the magnetopause. In a follow-up project funded by NASA's Geospace Science Program, we will build upon these initial results and further compare with THEMIS observations to quantify the rate of transport of solar wind plasma into the magnetosphere.

Impact on National Missions

This research exploited the newest generation of petascale supercomputers using a kinetic simulation code (VPIC) specially optimized for these machines. Some of these calculations were performed locally at Los Alamos using NNSA computers, while other calculations were performed on flagship DOE supercomputers such as Jaguar at Oak Ridge National Laboratory. These efforts are at the very forefront of high performance computing, both in terms of scaling the calculations to large numbers of cores (~100,000) and in remote visualization and analysis of the results. Our new predictions from this research will benefit current and upcoming NASA missions focused on understanding the near-Earth space environment. In particular, the upcoming Magnetospheric MultiScale (MMS) mission will focus on the kinetic physics of magnetic reconnection within the Earth's magnetosphere and will provide high-fidelity measurements that are directly relevant to our large-scale simulations. We anticipate our research will have a significant impact on the scientific understanding of this data.

Flux rope development and mixing

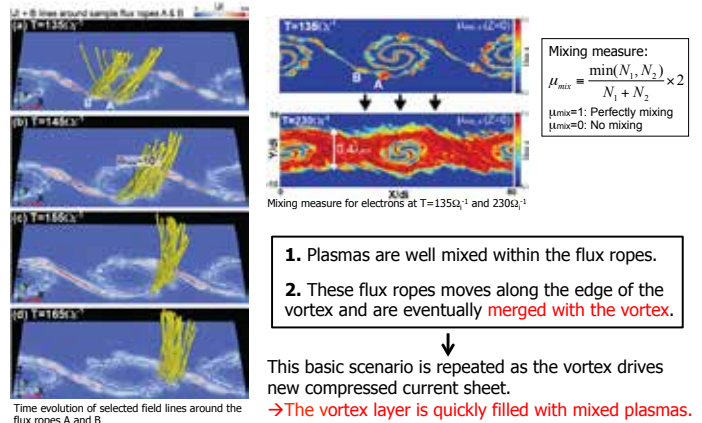

Figure 1. Left panels show the time evolution of the current density (red) from a 3D simulation of vortex-induced reconnection along with sample magnetic field lines (yellow). The development of 3D flux ropes gives rise to the chaotic mixing of magnetic field lines across the vortices and rapid mixing of particles along the field lines as shown in the right panels. For further details see Ref. [2].

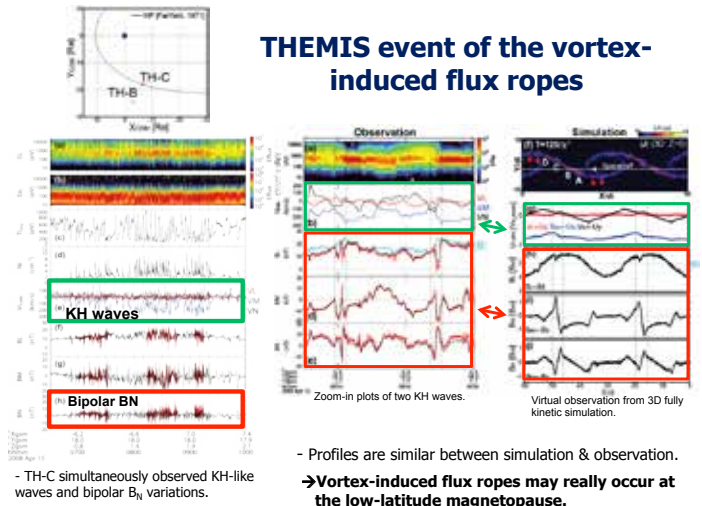

Figure 2. Comparison of THEMIS spacecraft observations (left panels) with 3D VPIC simulations (right panels). For further details, see Ref [2].

References

1. Nakamura, T., M. Fujimoto, and A. Otto. Magnetic reconnection induced by weak Kelvin-Helmholtz instability and the formation of the low-latitude boundary layer. 2006. Geophysical Research Letter. 33: 1.
2. Nakamura, T. K. M., W. Daughton, H. Karimabadi, and S. Eriksson. Three-dimensional dynamics of vortex-induced reconnection and comparison with THEMIS observations. 2013. JOURNAL OF GEOPHYSICAL RESEARCH-SPACE PHYSICS. 118 (9): 5742.

Publications

Karimabadi, H., V. Roytershteyn, M. Wan, W. H. Matthaeus, W. Daughton, P. Wu, M. Shay, B. Loring, J. Borovsky, E. Leonardis, S. C. Chapman, and T. K. M. Nakamura. Coherent structures, intermittent turbulence, and dissipation in high-temperature plasmas. 2013. PHYSICS OF PLASMAS. 20 (1): -.

Nakamura, T. K. M., R. Nakamura, A. Alexandrova, Y. Kubota, and T. Nagai. Hall magnetohydrodynamic effects for three-dimensional magnetic reconnection with finite width along the direction of the current. 2012. JOURNAL OF GEOPHYSICAL RESEARCH-SPACE PHYSICS. 117: -.

Nakamura, T., W. Daughton, H. Karimabadi, and S. Eriksson. Three-Dimensional Dynamics of Vortex-Induced Reconnection and Comparison with THEMIS Observations. 2013. Journal of Geophysical Research. 118: doi:10.1002/jgra.50547.

Nuclear and Particle Futures

Postdoctoral Research and Development
Final Report

Atomic Coherence with X-Ray Free-Electron Lasers

Bruce E. Carlsten
20120754PRD2

Abstract

This project was aimed at extending atomic coherence phenomena to the X-ray regime by exploring novel designs for future X-ray lasers that provide X-ray radiation with high spectral brightness. Two designs were considered. We first examined a free electron laser operating in self-amplified spontaneous emission mode driven by a bi-energetic electron beam. This original design required efficient parametric interaction between low- and high-energy portions of the beam in order to be deemed practical. Our model showed that efficient parametric interaction requires very high current for the low-energy portion of the beam. Hence, we switched our efforts to studying a known design that is based on enhanced self-amplified spontaneous emission (ESASE). The obtained X-ray radiation consists of trains of ultra-short pulses and can be used to excite atomic coherence resonant with the train frequency. The parameter optimization of the ESASE mode of operation of the LANL MaRIE facility showed that optical combs with high degree of correlation can be generated and that they are sufficient to excite a zero order resonance. We see future improvements to the current results in combining ESASE mode of operation with the purified self-amplified spontaneous emission (pSASE) scheme in order to further increase spectral brightness of the radiation. We also recommend future exploration of the use of atomic coherence for spectral cleaning of the radiation due to mechanism of self-matching.

Background and Research Objectives

Atomic coherence with intense visible and infrared lasers is an exciting emerging field that allows exploration of novel atomic behavior through controlling recombination rates, suppressing absorption and modifying dispersion, which leads to slowing down or speeding up the propagation of the light. These effects are being actively exploited in contexts of quantum heat engines; quantum information storage and processing; atomic traps, clocks, magnetometers and interferometers; novel laser

systems and have already become important for material science and technology. As the laser wavelength often determines size and resolution of possible applications, using intense X-ray lasers opens up possibilities for additional new applications and phenomena. Thus, the purpose of this theory and modeling project was to extend the emerging field of atomic coherence to the X-ray regime.

The best X-ray lasers currently available are free electron lasers (FELs) that operate in self-amplified spontaneous emission (SASE) mode. The Linac Coherent Light Source (LCLS) was the first X-ray FEL built here in the United States (at the SLAC National Accelerator Laboratory), where several recent experiments have shown that, although it is possible to excite atomic coherence in order to modify the transition rates of Neon, available X-ray radiation is not coherent enough to provide noticeable effects. Thus novel designs for future X-ray FELs are required in order to make them suitable for fundamental atomic and quantum research.

The first research objective was to investigate a novel X-ray FEL design based on a bi-energetic electron beam. This novel design relies on the parametric interaction of a fundamental harmonic generated by the high energy portion of electron beam with its sub-harmonic that is resonant with low energy portion of electron beam. We investigated the efficiency of this interaction and expect that via this interaction the longitudinal coherence of the sub-harmonic can be imprinted onto the fundamental harmonic thus boosting spectral brightness of SASE X-ray FEL.

Our second research objective for FY14 was to examine operation of the LANL MaRIE facility in enhanced self-amplified spontaneous emission (ESASE) mode. This approach was originally proposed by A. Zholents to mitigate poor electron beam quality by periodic current modulation in order to achieve higher peak currents and

provided favorable conditions for SASE generation. We saw an additional benefit that ESASE mode of operation has over traditional SASE mode – it generates a periodic train of atto-second pulses. The usefulness of periodic trains of pulses of light has been already shown. It has become a valuable tool for atomic and molecular sciences with visible and infrared light. Thus, we focused on studying the possibility of using ESASE X-ray FELs as a tool for excitation of atomic coherence with X-ray light.

In the course of our work, we formed additional future objectives. The first one was to combine ESASE mode of operation that produces partially correlated periodic trains of pulses with purified self-amplified spontaneous emission (pSASE) approach that improves the phase properties of X-ray radiation. The combination of these two approaches should further improve the spectral brightness of X-ray FELs and increase pulse correlations in a train. The second objective was to explore the propagation of the train of pulses in atomic medium under the conditions that efficiently excite atomic coherence. We expect self-matching of the pulses to occur thus boosting the spectral brightness of the radiation and the quality of exited atomic coherence.

The overall focus of this project was to investigate novel designs of X-ray free electron lasers that offer X-ray radiation with increased spectral brightness needed to excite atomic coherence. The expected results were: parametric X-ray generation in bi-energetic electron beam; X-ray optical combs generation corresponding to the train of optical pulses produced by the LANL MaRIE X-ray FEL operating in ESASE mode.

Scientific Approach and Accomplishments

The one dimensional (1D) theory of FEL operation has been sufficient to describe all aspects of conventional SASE FELs. In order to achieve the first research objective, we generalized the 1D theory of FEL operation in order to account for bi-energetic electron beams. Retaining the necessary harmonics, we provided a self-consistent description of electron beam interaction with X-ray radiation.

Using a quiet start approach with shot-noise initiation of the phase distribution, we numerically modeled SASE operation of this bi-energetic X-ray FEL. The simulation has shown that the low energy portion of the electron distribution has to have currents ten to a hundred times higher in order to provide significant parametric interaction of the fundamental harmonic from the high energy portion of the beam with its sub-harmonic that is a fundamental harmonic for the low energy portion of the beam. Thus we have concluded that this mode of operation is not practical as the most energy is coming from the low energy portion

of the electron beam.

In order to achieve the second research objective, we modeled ESASE mode of operation of the LANL MaRIE facility using three dimensional X-ray FEL code GENESIS. Since ESASE approach requires current modulation with high intensity infrared or visible laser that is not a part of a GENESIS code base, we developed a simulation code that computes electron distributions after the beam after has interacted with laser radiation and propagated through a chicane. We have used these electron distributions in the GENESIS based simulations of the ESASE mode of operation of the LANL MaRIE facility.

The current modulation depends on three parameters – laser wavelength, λ ; dimensionless electric field of the laser, A ; and dimensionless magnetic field of a chicane, B . The choice of these parameters affects the intensity of X-ray radiation, its periodicity and the bunch width. We have studied how the peak current, bunch width, and compressed fraction depend on all three parameters. As we discuss below, the optimum set has $\lambda = 1$ micrometer; $A=6.88$ and $B=0.21$.

We started by looking at the maximum laser power that one can use. High power lasers introduce substantial energy modulation that results in significant energy spread of the electron distribution after it propagates through a chicane. Increased energy spread affects X-ray FEL operation significantly. We therefore required that the laser modulation of the current increases the energy spread of the electron distribution by no more than factor of two above the intrinsic level determined by energy spread at the cathode, inter beam scattering (IBS) and necessary compression to achieve average current.

Starting with average current of 600 A, we used current modulation from an induced energy modulation through an interaction with an external laser in order to achieve peak currents as high as 3000 A, which is the operational peak current proposed for the LANL MaRIE facility. The intrinsic energy spread due to the cathode dynamic and current compression to 600 A was 100 keV. The inter beam scattering added an additional 110 keV to the energy spread of the electron distribution that affects current modulation significantly (Figure 1). By choosing the laser power such that dimensional laser field is $A=6.88$, we guaranteed that the additional energy spread was no more than 300 keV.

Figure 1 shows our analysis of the dependence of current modulation on the chicane strength with and without IBS included for a laser with 1 micrometer wavelength and $A=6.88$. This analysis shows significant influence of the IBS,

which lowered peak current by about 30%, broadening the width of current bunches and slightly affecting the compressed fraction.

Using the X-ray FEL code GENESIS, we compared FEL operation with four current bunches for different chicane strength in the presence of the IBS. Although having a high peak current is preferred from a design prospective as it increases the gain, the compressed fraction and the width of the bunch are the governing factors here. For example, the compressed fraction defined the amount of electrons in the high current region and directly determined the total photon flux achievable for a given charge. The efficiency of the generation, however, depends even stronger on the ratio of the current bunch width to the slippage length. The bunch length scales linearly with the choice of radiation wavelength, λ , given that all other conditions are equal. The slippage length is defined by the distance radiation slips ahead of the bunch due to propagation in an undulator and depends on the peak current very slowly. For current bunches much shorter than the slippage length, efficiency drops significantly due to short interaction distance between radiation and the electrons. This also leads to increased bandwidth as the coherence length is now determined by the current bunch width instead of the slippage length. We have chosen $\lambda = 1$ micrometer as the optimum choice. Figure 2 shows results of the Genesis 1.3 simulations. One can see that the chicane strength, $B=0.21$, provides the highest photon flux at saturation with relatively low bandwidth. Operation beyond the saturation requires increased chicane strength to $B=0.27$, which leads to higher bunch width, in order to accommodate for increased slippage length.

Our final optical comb generation was performed with 45 current bunches in the case of a chicane with $B=0.21$. Figure 3 shows the optical spectrum at the saturation distance of 62 meters together with its autocorrelation function. It clearly demonstrates the presence of optical comb that maintains its correlation for about 5 periods. Working at a shorter distance of 47 meters increase the correlation to about 7 periods.

We used the best optical clomb generated with 45 current bunches in order to test its ability to excite an atomic coherence. To this end, we developed a closed three level model that describes an interaction of such radiation with a test atom. Our numerical simulations have shown that the excitation of atomic coherence is possible at zero order resonance (see the blue line in Figure 4).

In Figure 4, we show normalized time along the duration of the electron beam. In this unit of time, low frequency coherence has been assumed to decay at 10^{-3} rate while

the high frequency coherence decays at 10^3 rate. We have optimized the strength of atom-field interaction, described by the Rabi frequency and equal to 2×10^3 , in order to observe coherence excitation in the case when level splitting is equal to zero.

We expected that atomic coherence with similar efficiency could be excited at 1st order resonance where level splitting is equal to the repetition frequency. The fact this has not happened indicates that we did not have sufficient phase correlation between optical pulses. Therefore, we decided to combine the pSASE approach with the ESASE mode of operation in order to increase the spectral correlations in future work.

Although excited atomic coherence at the 1st order resonance does not reach its maximum value, it is not zero and thus demonstrates that ESASE based optical combs can excite atomic coherence. In this regard, we are now developing numerical tools in order to study propagation of X-ray radiation in atomic medium with excited coherence. We are expecting to see self-matching of the pulses in a train due to excited atomic coherence. This self-matching should lead to cleaning of the spectrum and facilitate a higher efficiency for the atomic coherence excitation.

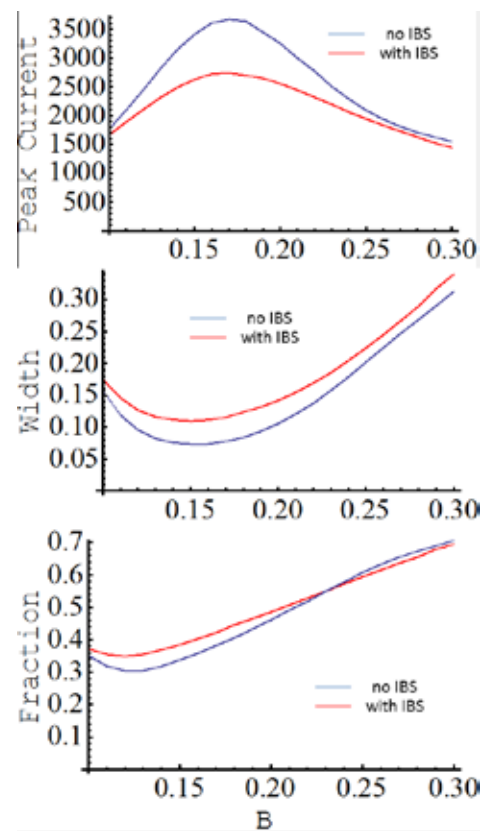

Figure 1. Current modulation parameters with laser vs. chicane strength for $l=1$ micrometer and $A=6.88$. The blue lines are for the case without inter beam scattering and the red lines are for the case with inter beam scattering.

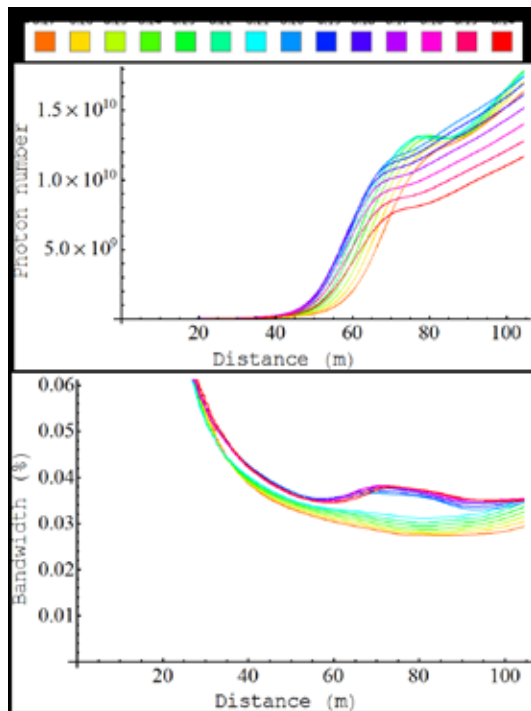

Figure 2. GENESIS 1.3 simulation of ESASE operation mode for the LANL facility MaRIE.

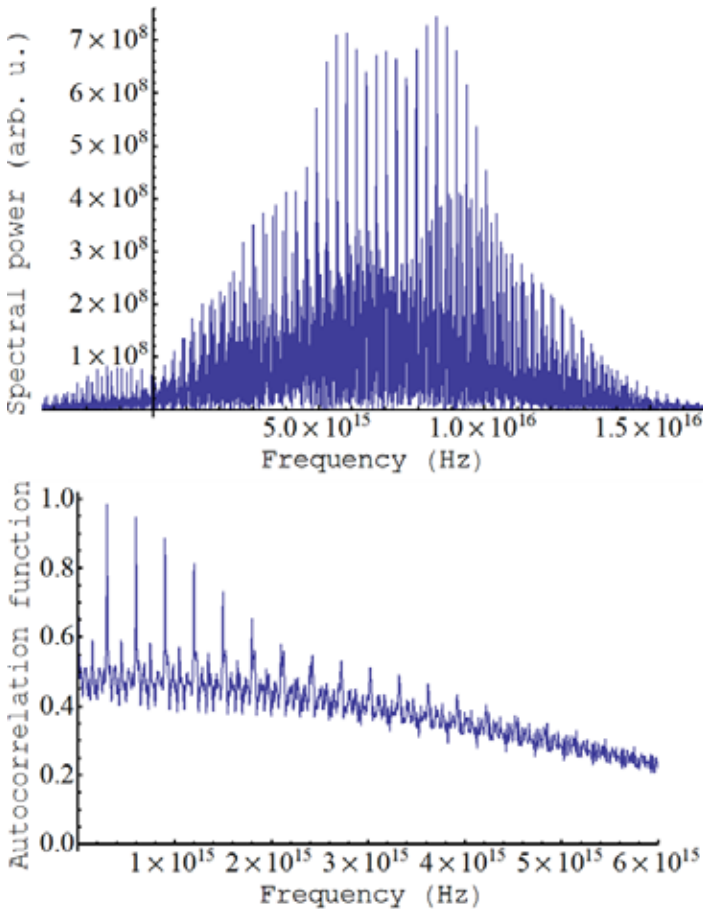

Figure 3. Optical comb produce in ESASE mode of X-ray FEL operation at the saturation distance of 62 meters with its autocorrelation function provided below.

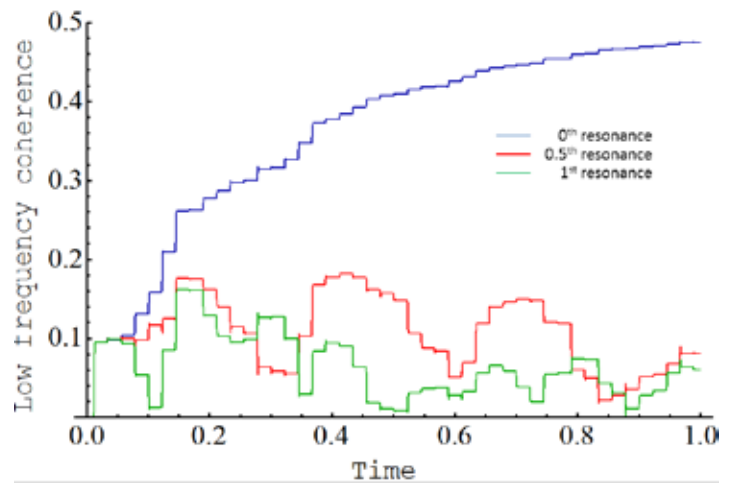

Figure 4. Atomic coherence at the low frequency transition in a three-level atom. Blue line provides evidence of efficient excitation for a zero splitting of the levels; green line is for a splitting equal to the repetition frequency.

Impact on National Missions

This fundamental research may lead to enhanced materials performance and devices relying on atomic technologies, such as x-ray spectroscopy and high precision magnetometers with angstrom resolution. It can open the possibility on optical storage of quantum information at a high density due to reduced radiation wavelength.

Publications

Anisimov, P. M., and N. A. Yampolsky. Response function description of the space-charge fields in azimuthally symmetric relativistic beams. Physical Review Special Topics - Accelerators and Beams.

Precision Fission Cross Section Measurements with a Time Projection Chamber (TPC)

Fredrik Tovesson
20120755PRD2

Abstract

The fission cross sections of major actinides are being measured at LANSCE with a Time Projection Chamber (TPC). Dr. Rhiannon Meharchand was funded by the LDRD program to work on research with the TPC. Rhiannon supported several beam experiments with the TPC and completed the analysis of the U-238/U-235 fission cross section ratio. This was the first fission cross section measured by the new instrument, and the analysis was essential for benchmarking its performance. Rhiannon developed procedures for using the particle tracking capability of the TPC to reduce systematic uncertainties in the cross section normalization, and quantified beam-related background levels in the experiment.

The work that Rhiannon performed in preparing, setting up and maintaining beam experiments at LANSCE directly contributed to the first publication on the full TPC instrument [4], and her cross section analysis results have resulted in several reports and publications [1,2,3,5,6].

Background and Research Objectives

In a nuclear fission reaction the atomic nucleus splits into two or more light nuclei (fission fragments), releasing energy and several neutrons. Nuclei that undergo fission after capturing a neutron are referred to as fissionable isotopes - examples include Uranium-238 (U-238), Uranium-235 (U-235) and Plutonium-239 (Pu-239). The goal of this work was to study the neutron-induced fission of fissionable isotopes by measuring the reaction probability, known as the cross-section, as a function of the energy of the incident neutron.

Fission cross sections have traditionally been measured with ionization chambers (also known as fission chambers). These measurements are typically accurate to 3-5%, limited by systematic uncertainties such as particle identification (distinguishing fission fragments from other charged-particle events) and non-uniformities in

the fissionable sample and neutron beam. To achieve the accuracy levels required for applications a new approach is needed; to this end, the Neutron Induced Fission Fragment Tracking Experiment (NIFFTE) collaboration is currently developing a Time Projection Chamber (TPC) for fission research. The TPC has several advantages over standard ionization chambers, most notably when it comes to providing insight into sources of systematic error.

The principle of operation of the TPC is shown in Figure 1. Charged particles passing through the detector fill gas produce ionization electrons, which drift through a uniform electric field towards a highly segmented readout plane. The segmented readout allows one to reconstruct a two-dimensional projection of the particle's path through the detector. This is then combined with the drift time of the electron to yield a complete, three-dimensional picture of the particle trajectory. This tracking information can help measure sample uniformity, beam profile, particle identification, and other factors that had to be estimated in previous ionization chamber measurements.

The primary TPC deliverable – the Pu-239 neutron-induced fission cross section – is scheduled to be delivered to the sponsors in FY17. Building towards that deliverable, however, it is crucial that TPC performance be benchmarked, opening the possibility for independent research like our postdoc's. U-238 and U-235 are considered to be cross section standards, meaning that the cross-section is known with high accuracy. For U-235, many measurements have been made over a wide range of incident neutron energies. For U-238, many measurements exist up to approximately 20 MeV, but the data at higher energies are scarce and far more discrepant. Comparing the U-238/U-235 cross-section ratio obtained with the TPC to previous measurements should therefore achieve two goals: (1) for neutron energies below 20 MeV, this measurement will provide confirmation

that the project is on-track to obtain the required accuracy for the Pu-239 measurement; (2) for neutron energies above 20 MeV, the U-238 measurement provides a valuable piece of nuclear data to the community and could significantly impact the current U-238 standard. The research objectives of this work were to facilitate and coordinate TPC experiments and to analyze U-238/U-235 cross-section ratio data collected during the 2012 experimental run. This particular cross-section measurement, despite being crucial for the credibility of the NIFFTE project, is completely outside the programmatic scope (which only includes Pu-239 measurements) and fulfills an important nuclear data need, making it well-suited for LDRD funding.

TPC experiments take place at the Los Alamos Neutron Science Center (LANSCE) Weapons Neutron Research (WNR) facility. The experimental run cycles last for 4-6 months, and each month typically contains three weeks of running with one week maintenance period. NIFFTE collaborators come to LANSCE to assist with sample changes and experimental setup, and many take online “shifts” in which they monitor the experiment remotely. The local Los Alamos NIFFTE team maintains the experimental equipment throughout the run cycle and provides all on-site support.

The Director’s funded postdoc set up the experimental area for each run cycle: installing equipment, electronics, auxiliary systems, etc. and helping to assemble and install the TPC detector itself. During this process, she drafted guides and manuals to streamline the process for bringing outside users into LANL, documented detector assembly procedures, and instructed on-site and remote shifters on how to monitor data quality and troubleshoot problems. She also developed and tested procedures for safely loading radioactive samples into the TPC using a glovebox, procedures which resulted in the first-ever successful loading of a Pu-239 sample into the TPC. Throughout each run cycle she provided on-call support and maintenance, facilitated data-collection with U-238, U-235, and Pu-239 targets. Although each run was different, the detector was typically taking high-quality “production” data ~70% of the available beam time, a remarkable accomplishment considering that until the 2013 run cycle the project was still in the detector development/prototyping stage.

In addition to facilitating and coordinating TPC experimental efforts she was also responsible for analyzing the U-238/U-235 ratio data collected during the 2012 experimental campaign. This analysis is nearing completion, and at this point a preliminary cross section has been deduced and efforts are focused on the quantification and minimization of uncertainties.

Additional objectives developed during the course of this project include a successful proposal funded by C-1 to study the feasibility of measuring fission fragment yields with the TPC, and a new experimental effort to measure the total kinetic energy (TKE) release in fission of U-235 and Pu-239. These new experimental efforts, combined with the TPC measurements, should contribute to a much more complete understanding of the nuclear fission process.

Scientific Approach and Accomplishments

TPCs have been used in high-energy physics research for decades – the NIFFTE TPC, however, marks the first application of TPC technology to fission research. This is a formidable task, involving many complex systems and state-of-the-art technology. A schematic of the TPC is shown in Figure 2. The sample to be studied sits at the center of the detector, located in the central plane of a uniform electric field. The detector volume is encased inside an aluminum pressure vessel, which can hold pressures up to 5 bar. The gas handling system is capable of mixing and supplying three different gases to the chamber. At each end of the chamber there is a readout (“pad”) plane made up of 2796 individual readout channels. MICROMEGAS detectors are used to amplify and read out the drifted charge on each pad. A complete description of the TPC design will be available in a forthcoming publication. Figure 2

To date, the most significant technical accomplishments have been the construction of the TPC detector and successful execution of experimental campaigns studying neutron-induced fission cross sections of U-238, U-235, and Pu-239. During the 2010 LANSCE run cycle, the first for the NIFFTE TPC, data were collected using a prototype detector with 64, then 192 channels instrumented. In 2011, 496 channels (1/12 of the full detector) were instrumented, and many new hardware systems were implemented as the detector transitioned from prototype to production. 2012 saw 2976 (1/2 the full detector) instrumented and for the first time in the history of the project, timing information was available that allowed one to deduce the incident neutron time-of-flight (energy). Most recently, the 2013 run cycle was the first in which the fully instrumented detector was in use.

The analysis of these data is ongoing. Analysis topic leaders have been assigned to coordinate the efforts for each isotope, and preliminary results have been reported at several conferences and meetings. Project overviews and results from the U-238/U-235 cross-section campaign have been presented at:

- Invited seminars at Roosevelt University, University of Notre Dame, University of Massachusetts Lowell,

Massachusetts Institute of Technology, and Bucknell University (2014)

- The American Physical Society (APS) Division of Nuclear Physics (DNP) Fall Meeting, Newport News, VA (2013)
- The Gordon Research Conference (GRC) on Nuclear Chemistry, New London, NH (2013). Winner: Best Poster Award
- The International Conference on Nuclear Data and Technology, New York, NY (2013). Refereed conference proceedings to be published in Nuclear Data Sheets (2014).
- The Cross Section Evaluation Working Group Meeting, Brookhaven, NY (2012)
- The Nuclear Physics Working Group Meeting, Las Vegas, NV (2012)

Publications on the TPC design (lead author: M. Heffner, LLNL) and U-238/U-235 cross-section ratio are in preparation.

Impact on National Missions

This work strengthens LANL's position as a premier laboratory for nuclear science in support of national security and energy research. Neutron-induced fission cross-sections are fundamental to the understanding of nuclear weapons and nuclear reactors. Due in part to international testing restrictions, the readiness of our nuclear deterrence depends largely on simulation tools, which are only as reliable as their nuclear data input. Sensitivity studies on nuclear technologies indicate a more precise determination of the Pu-239 fission cross section is needed, and to that end the weapons program is currently funding high-precision (sub-1%) measurements. The design of next-generation nuclear reactors also relies on advanced simulation tools, and sensitivity studies have also shown that for some key fission cross sections improved measurement accuracy will significantly impact system calculations and predictions.

The project has helped develop a new capability for high precision nuclear data measurements that benefits several laboratory programs. It will provide valuable data on the neutron-induced fission cross section of U-238 to the nuclear data community. It has also brought a talented early career researcher (Rhiannon Meharchand) to LANL, and she will likely be offered a staff member position in LANSCE-NS at the end of her term as a postdoctoral researcher.

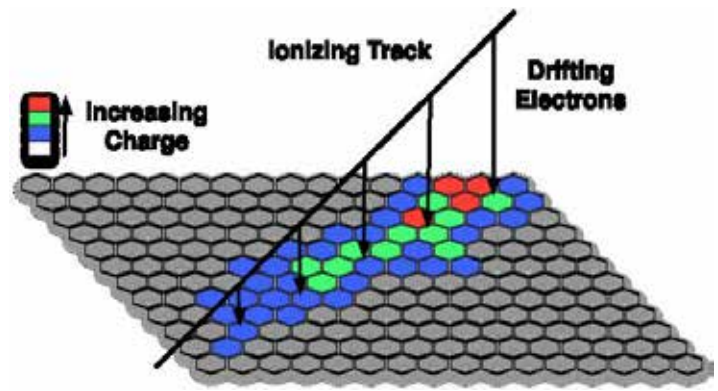

Figure 1. Basic illustration of TPC measurement concept.

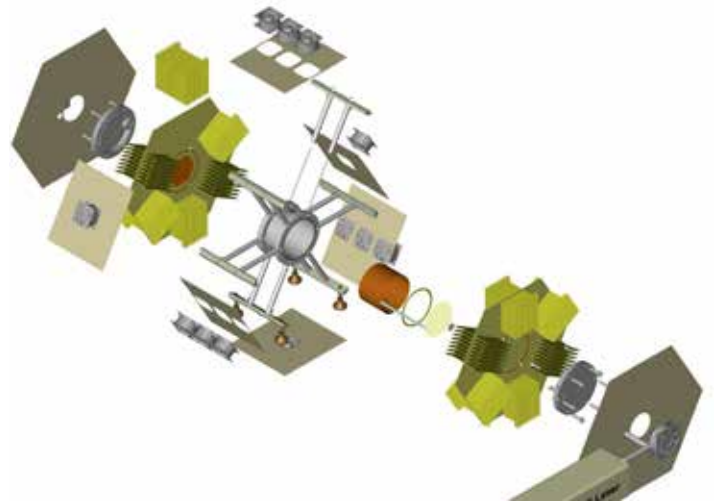

Figure 2. Expanded view of the TPC.

Publications

Heffner, , D. M. Asner, R. G. Baker, Baker, Barrett, Brune, Bundgaard, Burgett, Carter, Cunningham, Deaven, D. L. Duke, Greife, Grimes, Hager, Hertel, Hill, Isenhower, Jewell, King, J. L. Klay, Kleinrath, Kornilov, Kudo, A. B. Laptev, Leonard, Loveland, T. N. Massey, McGrath, Meharchand, Montoya, Pickle, Qu, Riot, Ruz, Sangiorgio, Seilhan, Sharma, Snyder, Stave, Tatishvili, R. T. Thornton, Tovesson, Towell, R. S. Towell, Watson, Wendt, Wood, and Yao. A time projection chamber for high accuracy and precision fission cross-section measurements. 2014. NUCLEAR INSTRUMENTS & METHODS IN PHYSICS RESEARCH SECTION A-ACCELERATORS SPECTROMETERS DETECTORS AND ASSOCIATED EQUIPMENT. 759: 50.

Meharchand, , D. M. Asner, R. G. Baker, Bundgaard, Burgett, Cunningham, Deaven, D. L. Duke, Greife, Grimes, Heffner, Hill, Isenhower, J. L. Klay, Kleinrath, Kornilov, A. B. Laptev, Loveland, T. N. Massey, Qu, Ruz, Sangiorgio, Seilhan, Snyder, Stave, Tatishvili, R. T. Thornton, Tovesson, Towell, R. S. Towell, Watson, Wendt, and Wood. Commissioning the NIFFTE Time Projection Chamber: Towards the U-238/U-235 (n,f) Cross-section Ratio.

2014. NUCLEAR DATA SHEETS. 119: 373.

Meharchand, R., F. Tovesson, A. B. Laptev, and K. Meierbachtol. TPC measurement support. 2012. LANL internal report LA-UR-12-25409.

Meharchand, R., T. Hill, and L. Snyder. Analysis of TPC Single Sextant U-238/U-235 Engineering In-Beam Data. 2012. LANL Internal Report LA-UR-12-25452.

Snyder, , D. M. Asner, R. G. Baker, Bundgaard, Burgett, Cunningham, Deaven, D. L. Duke, Greife, Grimes, Hefner, Hill, Isenhower, J. L. Klay, Kleinrath, Kornilov, A. B. Laptev, Loveland, T. N. Massey, Meharchand, Qu, Ruz, Sangiorgio, Seilhan, Stave, Tatishvili, R. T. Thornton, Tovesson, Towell, R. S. Towell, Watson, Wendt, and Wood. Measuring the alpha/SF Branching Ratio of Cf-252 with the NIFFTE TPC. 2014. NUCLEAR DATA SHEETS. 119: E386.

Snyder, , D. M. Asner, R. G. Baker, Bundgaard, Burgett, Cunningham, Deaven, D. L. Duke, Greife, Grimes, Hefner, Hill, Isenhower, J. L. Klay, Kleinrath, Kornilov, A. B. Laptev, Loveland, T. N. Massey, Meharchand, Qu, Ruz, Sangiorgio, Seilhan, Stave, Tatishvili, R. T. Thornton, Tovesson, Towell, R. S. Towell, Watson, Wendt, and Wood. Measuring the alpha/SF Branching Ratio of Cf-252 with the NIFFTE TPC. 2014. NUCLEAR DATA SHEETS. 119: 386.

Nuclear and Particle Futures

Postdoctoral Research and Development
Final Report

The Assembly of Primeval Galaxies and the Birth of the First Quasars

Hui Li

20120756PRD2

Abstract

Primordial supernova explosions are catalysts for the formation of the first galaxies in the universe because they chemically enrich their surroundings with heavier elements that trigger second-generation star formation. They are also important for finding the earliest galaxies at all, since some of these primitive structures are otherwise too dim to be detected in wide-field surveys. During my Fellowship we have modeled the light curves and spectra of the first SNe in the universe with the radiation hydrodynamics code RAGE including core-collapse, pair-instability, Type II_n, and supermassive thermonuclear events. We have characterized their observational profiles and have shown that these ancient explosions will be detectable by the James Webb Space Telescope (JWST) and the Wide-Field Infrared Survey Telescope (WFIRST) at the earliest epochs in the universe. Both JWST and WFIRST are future flagship, spaceborne observatories for NASA, and our results provide some important predictions about the possible science that they will carry out.

Background and Research Objectives

The light emission from Population III (Pop III) stars was believed to be one of main processes that ended the cosmological dark ages and made the Universe transparent to light. This is often referred to as reionization. While these objects produced enormous amount of ionizing photons, they also created the first elements heavier than lithium, making it possible for later stars and planets to could form. The main mechanism by which these Pop III stars enriched their surroundings is through core-collapse supernova blasts (CCSN). These CCSN are events where the gravitational pressure overcomes the thermal pressure and a massive implosion occurs. During this implosion, a tremendous amount of energy, often on the order of 10^{51} erg, is released in the form of neutrino creation. These neutrinos then power a strong shock that gives rise to a supernova blast. It is during this blast that the heavier elements found in the

centers of the Pop III stars are released.

Pop III CCSN blasts are also important because they might be the only observable objects from the high-redshift universe around the time of reionization. Thus these events provide a unique window on the Universe in the first few hundred million years after the big bang. It is hoped that future surveys such as JWST and WFIRST will be able to directly detect these objects and observe their light curve features. If that is the case, we would be able to quantify things such as their mass, energy, chemical make-up, and other things that will help us constrain the physics of the early universe, such as the initial star formation rate.

Scientific Approach and Accomplishments

To study CCSN, we need to model a range of physical processes, including massive implosions, radiation hydrodynamics, nuclear physics, and production of light. To this end, we have utilized the lab's Eulerian radiation-hydrodynamics code known as RAGE. Since it is still uncertain how massive these Pop III stars can be (and the implosion and explosion processes are functions of the stellar masses), our basic approach included several stages: 1) we study the stellar evolution and its final implosion+explosion dynamics; 2) we study the shock generated by explosion and its evolution in different stages; 3) we study the light signals from such powerful expansions. The images and light-curves from these simulations will then serve as predicted templates for future observations.

We first obtained initial Pop III stellar profiles for a variety of masses, energies and explosion types. (For example, pair-instability explosions versus hypernova.) We then evolved these blasts in RAGE for the first $1e8$ seconds after the initial explosion. We were able to simulate the shock breakout generated by the explosions, as well as the early, intermediate and late time stages of the fireball. From the outputs corresponding

to the different stages of evolution, we post processed the data using a lab code called SPECTRUM. SPECTRUM measures the spectra of the CCSN throughout each stage of the blast, allowing us to obtain light curves – the changing light of the supernova as the explosion progresses. From these light curves, we are able to predict what future surveys will see in each waveband.

This effort has resulted in 10 publications that built up a lightcurve database that future surveys will be able to use. These publications are listed in the publication section. We have published the observation details for many different classes of supernova. Furthermore, our “biggest explosions in the universe” research made it’s way into a TEDx Talk given at LANL this summer.

Impact on National Missions

These simulations are having a real science impact on the astronomy community. David Spergel and Jason Kaliari from Princeton and STScI have consulted us on filter designs for WFIRST (which is now in its planning stages) to detect these ancient events in the near infrared (NIR) and have solicited contributions from LANL on the science case for WFIRST to be submitted to NASA. Steve Rodney of the CLASH Survey has contacted us regarding a new proposal to use HST data to detect the candidates we modeled. Claes-Erik Rydberg has contacted us similarly regarding Frontier fields and John Mather of JWST has also reached out to build the science case for JWST. Reporters have also contacted us about our work, which now appears in the June 12, 2013 issue of *New Scientist* (The Supernova that Blew up a Galaxy). Our numerical models have culminated in the publication of 10 *Astrophysical Journal* publications.

In carrying out this fundamental research, we build capability for hydrodynamical simulation that can be brought to a range of applied national security challenges, foremost the weapons program. This was amply demonstrated when postdoc Smidt was recruited into a staff position in X-Theoretical Design, a weapons design division.

References

1. Johnson, Jarrett L., Daniel J. Whalen, Chris L. Fryer, Wesley P. Even, A. Heger, J. Smidt, and K. Chen. The Biggest Explosions in the Universe. 2013. *The Astrophysical Journal*. 775 (2): 8.

Publications

Johnson, J., D. Whalen, W. Even, C. Fryer, A. Heger, J. Smidt, and K. Chen. The biggest explosions in the universe. 2013. *The Astrophysical Journal*. 775 (2): 8.

Smidt, J., D. Whalen, J. Johnson, D. Holz, and C. Fryer. Detecting Ancient Supernovae at $z \sim 5 - 12$ with CLASH.

The Astrophysical Journal Letters.

Smidt, J., D. Whalen, W. Even, B. Wiggins, J. Johnson, and C. Fryer. Population III Hypernovae. *The Astrophysical Journal*.

Whalen, D., A. Heger, K. Chen, W. Even, J. Smidt, C. Fryer, M. Stiavelli, and H. Xu. Supermassive population III supernovae and the birth of the first quasars. 2013. *The Astrophysical Journal*. 778 (1): 12.

Whalen, D., J. Johnson, J. Smidt, A. Heger, W. Even, and C. Fryer. The supernova that destroyed a protogalaxy: prompt chemical enrichment and supermassive black hole growth. 2013. *The Astrophysical Journal*. 774 (1): 10.

Whalen, D., J. Johnson, W. Even, C. Fryer, A. Heger, J. Smidt, and K. Chen. The biggest explosions in the universe. II. 2013. *The Astrophysical Journal*. 777 (2): 9.

Whalen, D., J. Smidt, A. Heger, and R. Hirschi. Pair-Instability Supernovae in the Local Universe. *The Astrophysical Journal*.

Whalen, D., J. Smidt, W. Even, S. Woosley, A. Heger, M. Stiavelli, and C. Fryer. Finding the First Cosmic Explosions. III. Pulsational Pair-Instability Supernovae. To appear in *To Appear in the Astrophysical Journal*.

Whalen, D., L. Frey, W. Even, J. Smidt, C. Fryer, M. Stiavelli, D. Holz, A. Heger, S. Woosley, C. Lovekin, and A. Hungerford. Finding the first cosmic explosions I: pair-instability supernovae. 2014. *The Astrophysical Journal*. 781 (2): 8.

Nuclear and Particle Futures

Postdoctoral Research and Development
Final Report

Searching for Sterile Neutrinos with MicroBooNE

Richard G. Van De Water
20120757PRD2

Abstract

MicroBooNE is a liquid argon time projection chamber (LArTPC) that will detect neutrinos from Fermilab's Booster Neutrino Beamline. From the large sample of neutrino interactions that will be collected, MicroBooNE will perform short-baseline neutrino oscillation searches, will resolve the source of the MiniBooNE "low-energy excess," and will measure cross sections and properties of ~ 1 GeV neutrino interactions in liquid argon. Using LArTPC detection technology, MicroBooNE aims to see neutrino interactions in "high-definition," with event reconstruction and particle identification, critical for achieving its physics goals.

Background and Research Objectives

Neutrinos – the nearly massless, almost entirely invisible elementary particles – "oscillate" their flavor as they travel through space. Neutrinos are produced in three distinct flavors, each partnered with a charged lepton under the weak nuclear force, but surprisingly may appear as a different flavor some distance away, visible only with a very rare interaction with matter. While we still work to understand why this happens, it seems unrelated to any of the previously known laws of physics, leading us to wonder: can neutrinos oscillate into even more flavors, that have nothing to do with the weak nuclear force and don't interact in any known way? Searches for these "sterile" neutrinos have become an important part of the study of neutrino oscillations. If these particles are found, they would be the first new particles discovered that stand outside the current Standard Model of particle physics, and could be a fundamental tool in increasing our understanding of the world around us.

One of the most interesting experiments to have searched for sterile neutrinos was MiniBooNE. The MiniBooNE detector was a large sphere filled with mineral oil and surrounded by light detectors. The detector was located on the Booster Neutrino Beamline (BNB)

at Fermilab, where 8 GeV protons were fired at a beryllium target, producing an energetic spray of hadrons that decayed and produced a beam of mostly muon or anti-muon neutrinos (depending on a magnetic horn). MiniBooNE extensively studied muon neutrino interactions, but also searched for oscillations by looking for the appearance of electron neutrinos in this predominantly muon neutrino beam. The experiment found a strange excess of electron neutrino-like events at lower energies (below 450 MeV), that when combined with other hints of neutrino oscillations, could be explained by the existence of one or more sterile neutrinos.

But, MiniBooNE's "low-energy excess" might not be due to electron neutrinos at all. There are a number of other backgrounds in this low energy region. Most of them involve the production of a single energetic photon (or two photons where one photon is just not seen), instead of the electron neutrino interaction product: a single electron. In MiniBooNE, which identifies particles produced in neutrino interactions based on the shape of the Cerenkov light produced as they travel through the detector, electrons and photons look very similar, and are hard to disentangle. In order to resolve the source of the low-energy excess, we need a type of detector that can tell the difference between electrons and photons, looking in sharper detail at the neutrino interaction.

Thus, MicroBooNE, a large liquid argon time projection chamber (LArTPC), is being built and placed at near the same location on the BNB, to study the same neutrinos and look for the same low-energy excess. LArTPCs are large volumes of liquid argon placed under a high electric field. When charged particles travel through the detector, they ionize the argon, liberating electrons that will then drift with constant velocity from the cathode to the anode due to that electric field. At the anode, three planes of wires –each in a different orientation– read the signal of those electrons passing by. By looking at the time electrons arrive at the wires, and which

wires saw signals, we can reconstruct the position of the charged particles produced in neutrino interactions in 3D and with great spatial resolution due to a very fine, 3-mm wire pitch. The number of electrons we see at the wires can also tell us about the types of particles produced. This, in fact, is the way we can discriminate between electrons and photons: while both will create messy-looking electromagnetic showers in the detector, the amount of ionization at the beginning of those showers is smaller for electrons than for photons. With a detailed view of the very beginning of the electromagnetic shower, MicroBooNE will tell the difference between electrons and photons, and solve a crucial piece of the puzzle on MiniBooNE's results, and possibly the existence of sterile neutrinos.

Scientific Approach and Accomplishments

While the detection technology is promising for our physics goals, LArTPCs are certainly not without their challenges. The detector must maintain a very high electric field, very pure argon, and read out a large amount of data with very little noise. If any one of those requirements is not met, the ionization signals from neutrino interactions can be diluted, and the ability to tell the difference between electrons and photons may be lost. While working on the detector, I have focused on the testing of the readout electronics and the development of the data acquisition system. A block diagram of this system is shown in Figure 1.

MicroBooNE's front-end readout electronics start with CMOS ASICs mounted on motherboards that attach to the wires, inside the liquid argon. These cold electronics amplify and shape the signal from the TPC, which is then transported by cold cables through liquid and gaseous argon to a feedthrough on the cryostat holding the detector. While designing and operating electronics in liquid argon temperatures (87 K) is difficult, it leads to signals with very low noise. Intermediate amplifiers sit on the warm side of the feedthroughs and drive the signal across long, warm cables to the TPC readout crates, where the signal is digitized and prepared for transmission into the DAQ.

Tests of each element of these electronics were performed after production, after installation on the detector, and before and after each stage the detector or cryostat has moved. It is important to perform these checks to not only verify the readout channels are working properly, but a careful characterization of the electronics will be important to calibrating the ionization signals we see from the detector. I have helped develop, run, and analyze these tests using a full "vertical slice" of the readout and data acquisition system. These tests are the groundwork for detailed calibration studies we will conduct once the cryostat is

filled with liquid argon.

Once the data is processed by the electronics, it must be collected by PCs and stored for later analysis. This is the job of the data acquisition system. Data from the back-end readout electronics, which are combined into 10 readout crates, are sent to a PC (called a sub-event buffer, or SEB). There is one SEB dedicated to each readout crate. The SEBs perform some low-level checks on the quality of the data before sending it to an event-builder PC, which combines the data from each subsystem of the detector and writes the completed event to disk. Additional processes in the DAQ are responsible for the run control, configuration databases, slow-controls, and monitoring.

I have been a key contributor to the development and testing of the DAQ processes that directly handle the data: from collection on the SEBs to being written to disk on the event-builder. This involves many different pieces: collection of data from the TPC readout crates in both a triggered and continuous (untriggered) readout mode; packaging that data and transmitting it to the event-builder; building events using data from multiple SEBs; control of processes, via a message-passing system; the writing and reading of a serialized, versioned output data format; and, much else.

Alongside work on the detector, there is a large amount of work to be done on the reconstruction of the data to properly interpret. The basic reconstruction chain begins by calibrating the data directly from the detector to model the shape of the ionization pulse, and then finding regions on wires where there were significant amounts of ionization. These "hits" in the TPC then can be clustered together on each plane of wires independently, where we try to combine hits that likely originate from the same charged particle from the neutrino interaction. We then try to match these clusters, and other features of the event, across the three wire planes, and using the different orientations of the planes, construct a 3D image of the original ionization. We construct 3D tracks for line-like objects (e.g., muons, protons, and charged pions), while we try to combine the ionization from electrons or photons into 3D electromagnetic showers. We can then perform particle identification by looking at the ionization and how it changes along the path of the particle. An example of the wire plane information available from a typical event is shown in Figure 2.

A major challenge of this process is that it must be fully-automated. MicroBooNE will see over 100,000 neutrino interactions during its run, orders of magnitude more than any other LArTPC in a neutrino beam has ever seen. While previous experiments have benefitted from "hand-scans", where trained analysts look at displays of the data and

guide the reconstruction using their experience at pattern recognition, MicroBooNE will have far too many events to be able to use such methods. I have been a leader in the reconstruction effort, and helped form an automated reconstruction chain that can accomplish our main physics goals, and develop the tools necessary for benchmarking performance of our reconstruction algorithms. While much work is underway, MicroBooNE is well on the path to having a fully-automated reconstruction chain from the first day of data-taking.

A crucial part of this is the removal of cosmic rays from the event. MicroBooNE is a surface detector with limited overburden, and will see a significant amount of cosmic rays. During each readout window of the detector – defined by the 1.6 ms it takes for electrons to drift from the cathode to anode – we will see a number of cosmic rays punch into the detector and leave ionization tracks. A first step for any analysis will be to “tag” and remove those cosmic ray tracks, and then focus on the remaining neutrino interaction.

Cosmic-ray removal is done in two ways: by looking at cosmic ray tracks’ geometry, and by matching tracks in the TPC to flashes of light seen in MicroBooNE’s light collection system. For the former, tracks that clearly pierce through two boundaries of the detector, or that come from regions of drift that are inconsistent with the timing of the neutrino beam, can be tagged as cosmic rays and rejected (Figure 3). For the remaining tracks, we can compare them to “flashes” seen in MicroBooNE’s light collection system – an array of 32 photo-multiplier tubes that sit behind the wire plane. Flashes of scintillation light are produced alongside the ionization, and can be seen by the light collection system to give a time at which the ionization occurred. By comparing the predicted flashes that tracks in the TPC should leave to the observed ones, we can determine the time at which those tracks were created in the detector, and see if they are consistent with the timing of the neutrino beam. Those that are not can be tagged as cosmic rays and rejected.

I have been a leading member of the analysis team that is developing and benchmarking our cosmic-tagging algorithms. Preliminary results show ~90% of charge associated with cosmic rays being tagged as such, and a number of improvements are under development to push that higher. An early result from MicroBooNE will be to show our ability to isolate the neutrino interaction and perform basic cross section measurements for neutrino interactions on argon. Additionally, the rejection of non-track-like cosmic rays will be important for studies of the low-energy excess, and this work will stand as the foundation for handling these more difficult cosmic ray interactions.

Impact on National Missions

The work described here is part of the HEP (High Energy Physics) program to study fundamental particles and forces of nature. This program lays the foundation of knowledge and technologies for the basic mission of the lab. Furthermore, particle physics discoveries can have a profound impact on our understanding of the basic laws of physics, which can result in new and diverse technologies that can have a huge, and unpredictable, impact on the national mission. The skills developed in basic nuclear and particle work, like this, carry over to applied programs in nuclear security.

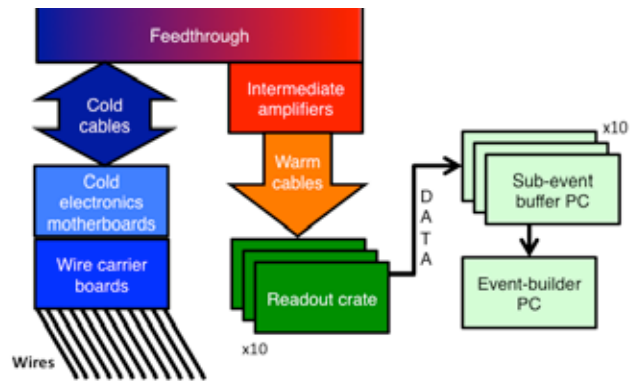

Figure 1. A diagram showing the flow of data from the detector, through the front-end and back-end electronics, and into the data acquisition system. The cold electronics sit on the top of the TPC inside the liquid argon. Signals from those electronics go over cables in the cryostat to a feed-through, where additional amplification on the warm side pushes the data into the readout crates. Each readout crate sends its data to a dedicated sub-event buffer (SEB) PC via an optical fiber, and then each SEB sends its data to a single event-builder over a 10 Gb Ethernet connection, where the event-builder then writes the event to disk.

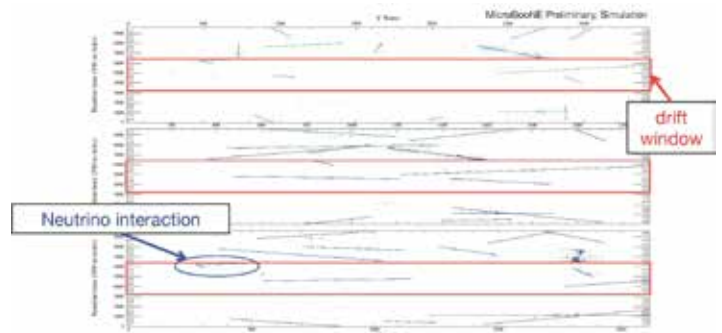

Figure 2. A simulated neutrino interaction event in MicroBooNE, showing the data collected on the wires in each of the three planes: the two induction planes (bottom two panels) and the collection anode plane (top panel). For each panel, the wire number (position in space) is shown on the horizontal axis, and the collection time is shown on the vertical axis. Highlighted in red is the drift window in each plane, showing the region corresponding to the neutrino interaction.

responding to where a neutrino interaction could occur, based on the timing of the neutrino beam arrival. Highlighted in blue is the neutrino interaction, which is surrounded by a number of cosmic rays that will need to be removed prior to analysis.

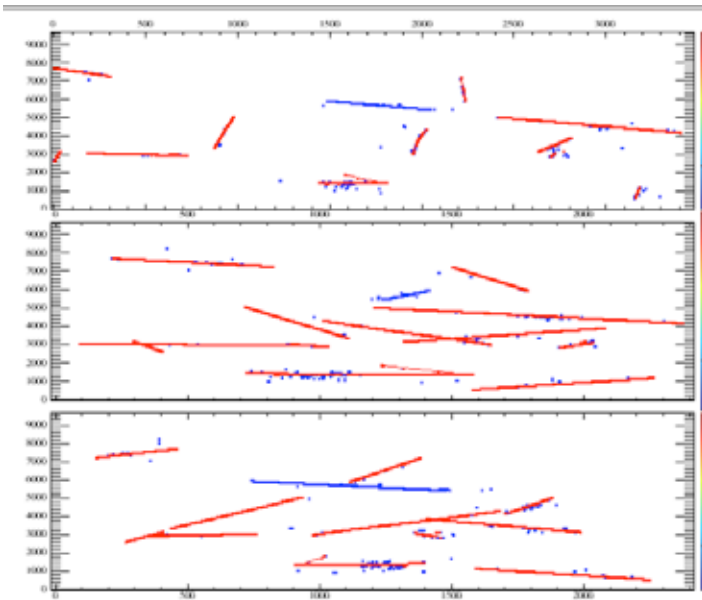

Figure 3. A simulated cosmic ray event in MicroBooNE, where we show all hits in each plane tagged as coming from cosmic rays in red, and those not tagged in blue. The tagging shown here is done strictly by looking at the geometry of the reconstructed charged particle tracks, looking for tracks that enter and exit the detector, or those that come from drift times inconsistent with the neutrino beam. Most tracks are positively tagged as cosmic rays, with the remaining tracks to be analyzed by comparing the track to flashes in the light collection system.

References

1. Ketchum, W.. "Short-baseline neutrino physics at Fermilab". To appear in Proceedings of the 37th international conference on high energy physics. (Valencia, Spain, 2014).

Nuclear and Particle Futures

Postdoctoral Research and Development
Final Report

Using Jet Production to Investigate quark-Gluon Plasma at RHIC

Xiaodong Jiang
20120775PRD4

Abstract

This is a progress report of project 20120775PRD4, for Dr. Michael McCumber's performance from Jan 2013 to March 2014, as a LANL Director's Fellow working in the Physics Division's P25 group, in the field of experimental high energy nuclear physics.

Background and Research Objectives

Dr. Michael McCumber joined the Los Alamos P-25 PHENIX team on January 14th 2013. On March 31st, 2014, Mike began a new position as a Frederick Reines Distinguished Postdoctoral Fellow and has since been very active in the field of experimental high energy nuclear physics. He pursued several new directions in the research of High Energy Heavy Ion Physics, taking initiatives in the new direction of detector upgrades and new physics program for the "planned-future upgrade" of the sPHENIX experiment at the Brookhaven National Laboratory's Relativistic Heavy Ion Collider (RHIC). This report is a summary of his activities during his time as a Director's Post-doc Fellow.

Scientific Approach and Accomplishments

Mike has been a leading physicist taking new initiatives and expanding the physics case for an upgraded detector program, sPHENIX, at RHIC prior to the planned future construction of an Electron Ion Collider (EIC). Through a very careful study, Mike has demonstrated the capabilities of forward jet reconstruction and an "effective method" of quark flavor tagging in p+p and Heavy Ion Collisions as a powerful tool to help to resolve the behavior of different flavored valence quark's transverse motion inside the nucleon and nucleus, an outstanding open question in our current understanding of nucleon's structure. Mike has been an influential member of the conceptual detector design team of sPHENIX, contributed to many details of the new detector's design and simulations, defining the entire scope of sPHENIX upgrade based on physics requirements of jet production in

p+p and Heavy Ion collisions. Mike assisted in organizing a productive forward sPHENIX workshop in Santa Fe this year. The efforts made during this time period have since resulted in large contributions to the sPHENIX MIE proposal (arXiv:1207.6378, and updated document as arXiv:1501.06197), forward physics white paper, and a very favorable DOE science review conducted in the summer of 2014. The above mentioned efforts of new sPHENIX physics design studies and new detector designs were not part of the baseline program, and would not have happened without the support of the LDRD-PRD project. Since the sPHENIX concept is a "possible-upgrade" in its initial proposal and planning stage, it is explicitly outside the regular scope of DOE Office of Science support.

In addition, Mike served as the senior member of three physics working group conveners for the PHENIX collaboration in the subject area of hard scattering with heavy ion collisions. In his role as convener he has organized weekly physics working group meetings, prepared new physics results for presentation at APS, JPS, DNP, Hard Probes, and Quark Matter conferences, shepherded analysis into 9 publications on hard physics during this time. At the end of this period, preparations for the Quark Matter 2014 conference would later lead to an additional 3 publications. For one of these papers (Published as Phys. Rev. Lett. 111, 212301 (2013)), he provided analysis, cross-checks, and was an important contributing author on the manuscript. He presented this work at the Denver APS meeting in April 2013, Recontres de Moriond, an important international QCD conference, in 2014, and the manuscript has now been published in PRL.

Outside of his immediate PHENIX duties, Mike has been investigating heavy quark flow and energy loss in a Langevin framework. This work, in collaboration with three others, has resulted in a manuscript published in PRC (Phys. Rev. C 90, 024911 (2014)) which offers insight into how to extract information about the time evolution

of heavy quarks in a flowing hydrodynamic system from experimental data. The tools and insights generated by this effort will be valuable to the PHENIX effort to measure these quantities with the VTX and FVTX.

Using the same hydrodynamic framework developed for this work, Mike and others argued in arXiv:1312.4565 and published in PRL (Phys. Rev. Lett. 113, 112301 (2014)) that He-3+Au collisions could be made at RHIC to robustly test the efficacy of hydrodynamics for describing multi-particle correlations in small collisions systems. Based on Mike's new initiatives, RHIC would later devote two weeks of beam time to this program at the end of Run 2014 during which Mike was serving as PHENIX's data taking period coordinator.

In recognition of his broad activities in the physics of hard processes in heavy ion collisions, Mike gave a summary of this subject at the Physics in Collision 2013 conference held in Beijing, China at the invitation of the conference organizers. The PIC conference series is a well-known popular venue in particle physics and organizers have in the past chosen a select few heavy ion speakers to relate new discoveries to this outside audience.

As a minor addition to these efforts made on his own behalf, this year Mike has served as referee for three articles and one letter for Physics Review.

Impact on National Missions

Mike's scientific research efforts at LANL's P25 group have put LANL in the forefront as one of the world's leading group in the field of Experimental High Energy Nuclear Physics. The research direction, especially the future sPHENIX studies that Mike is currently leading, clearly open up several new fronts, and new opportunities for US's Nuclear Physics program of DOE's Office of Science, and especially for LANL to play leading roles in nuclear physics for many years to come.

Publications

- Adare, A. M., M. P. McCumber, J. L. Nagle, and P. Romatschke. Examination whether heavy quarks carry information on the early-time coupling of the quark-gluon plasma. 2014. Phys. Rev. C. 90: 024911.
- Adare, A., C. Aidala, N. N. Ajitanand, Y. Akiba, H. Al-Bataineh, J. Alexander, A. Angerami, et.al. Cold-Nuclear-Matter Effects on Heavy-Quark Production in d+Au Collisions at root S -NN=200 GeV. 2012. PHYSICAL REVIEW LETTERS. 109 (24): -.
- Adare, A., C. Aidala, N. N. Ajitanand, Y. Akiba, R. Akimoto, H. Al-Ta'ani, J. Alexander, A. Angerami, K. Aoki, N. Apadula, Y. Aramaki, et.al. J/psi suppression at forward

rapidity in Au plus Au collisions at root s (NN)=39 and 62.4 GeV. 2012. PHYSICAL REVIEW C. 86 (6): -.

- Adare, A., S. Afanasiev, C. Aidala, N. N. Ajitanand, Y. Akiba, H. Al-Bataineh, J. Alexander, A. Angerami, et.al. Spectra and ratios of identified particles in Au plus Au and d plus Au collisions at root s (NN)=200 GeV. 2013. PHYSICAL REVIEW C. 88 (2): -.
- Adare, A., S. Afanasiev, C. Aidala, N. N. Ajitanand, Y. Akiba, H. Al-Bataineh, J. Alexander, A. Angerami, et.al. Transverse-momentum dependence of the J/psi nuclear modification in d+Au collisions at root s (NN)=200 GeV. 2013. PHYSICAL REVIEW C. 87 (3): -.
- Adare, A., S. Afanasiev, C. Aidala, N. N. Ajitanand, Y. Akiba, H. Al-Bataineh, J. Alexander, et.al. Measurement of transverse single-spin asymmetries for J/psi production in polarized p + p collisions at root s = 200 GeV (vol 82, 112008, 2010). 2012. PHYSICAL REVIEW D. 86 (9): -.
- Adare, A., S. Afanasiev, C. Aidala, N. N. Ajitanand, Y. Akiba, H. Al-Bataineh, J. Alexander, K. Aoki, et.al. Inclusive cross section and single transverse spin asymmetry for very forward neutron production in polarized p plus p collisions at root s =200 GeV. 2013. PHYSICAL REVIEW D. 88 (3): -.
- Adare, A., S. Afanasiev, C. Aidala, N. N. Ajitanand, Y. Akiba, H. Al-Bataineh, J. Alexander, et.al. Neutral pion production with respect to centrality and reaction plane in Au plus Au collisions at root S -NN=200 GeV. 2013. PHYSICAL REVIEW C. 87 (3): -.
- Adare, A., S. Afanasiev, C. Aidala, N. N. Ajitanand, Y. Akiba, R. Akimoto, H. Al-Bataineh, H. Al-Ta'ani, J. Alexander, A. Angerami, et.al. Medium Modification of Jet Fragmentation in Au plus Au Collisions at root S -NN=200 GeV Measured in Direct Photon-Hadron Correlations. 2013. PHYSICAL REVIEW LETTERS. 111 (3): -.
- Adare, A., S. Afanasiev, C. Aidala, N. N. Ajitanand, Y. Akiba, R. Akimoto, H. Al-Bataineh, H. Al-Ta'ani, J. Alexander, et.al. gamma (1S+2S+3S) production in d plus Au and p plus p collisions at root s (NN)=200 GeV and cold-nuclear-matter effects. 2013. PHYSICAL REVIEW C. 87 (4): -.
- Adare, A., S. Afanasiev, C. Aidala, N. N. Ajitanand, Y. Akiba, R. Akimoto, H. Al-Ta'ani, J. Alexander, et.al. Double-spin asymmetry of electrons from heavy-flavor decays in p plus p collisions at root s =200 GeV. 2013. PHYSICAL REVIEW D. 87 (1): -.
- Nagle, J. L., A. Adare, S. Beckman, T. Koblesky, J. O. Koop, D. McGlinchey, P. Romatschke, J. Carlson, Lynn, J., E., and M. McCumber. Exploiting Intrinsic Triangular Geometry in Relativistic $^3\text{He} + \text{Au}$ Collisions to Disentangle Medium Properties. 2014. Phys. Rev. Lett. 113: 112301.

Nuclear and Particle Futures

Postdoctoral Research and Development
Final Report

The Intersection of the Energy, the Intensity, and the Cosmic Frontiers in the Era of the Large Hadron Collider and XENON Experiments

Michael L. Graesser
20130789PRD2

Abstract

The project developed new theories for dark matter and the Higgs boson, and new algorithms to improve the experimental searches for new particles at the Large Hadron Collider. The project area is theoretical elementary particle physics.

The overall goal was to advance our understanding of particle physics at distances much smaller than a proton and during epochs in the early universe.

New methods are needed to improve the potential for the Large Hadron Collider (LHC) to discover new particles and to improve accuracy. The results of this project may be quite rewarding, since, for example, they may enable the LHC to discover and measure various decay modes of the Higgs boson.

Formulating new interactions between dark matter and the Higgs boson may lead to a new understanding for why the universe has more particles than anti-particles.

Background and Research Objectives

The overall goal of the project was to develop new methods and theories that may deepen our understanding of particle physics in two areas. One area is at distances 100-1000 times smaller than a proton, where we think the physics “responsible” for giving mass to fundamental particles is occurring. The other is during the epoch of the very early universe, when the abundance of dark matter was being set and when the excess of matter over anti-matter occurred.

To do that, the project developed new models for dark matter interacting with the Higgs boson, and simultaneously developed new experimental tools that will improve the ongoing searches at the Large Hadron Collider (LHC) for new particles. The research to look for connections between dark matter and the Higgs boson may provide us with a new framework for understanding

why the Universe has more particles than anti-particles. The work will either discover such a new framework, or provide us with a deeper understanding of the limitations of new interactions between the Higgs boson and dark matter.

An important research tool for understanding the implications of particle theories in a collider environment is the use of jets. Jets are energetic sprays of particles that are detected at collider experiments. Jet substructure refers to the physical properties of the particles inside the jet. The substructure of a jet depends on the physics that produced it.

The research in jet substructure physics will generate important tools that will: improve the potential for the LHC to discover new particles; and improve the ability of the LHC to perform more accurate measurements. Applied to the Higgs boson, these methods may be quite rewarding, since they may enable experimentalists at the LHC to discover and measure various decay modes of this particle.

Scientific Approach and Accomplishments

A significant part of Tuhin’s current research contributes to critical attempts being made by the contemporary particle physics community to come up with more refined tools for unraveling new physics information at the Large Hadron Collider (LHC).

Tuhin focused in particular on disentangling information stored in the particle physics objects that are referred to as “jets”. Jets are the output of jet-clustering algorithms that cluster the energy deposits observed in the LHC detector and, are thus, intrinsically dependent on the algorithm itself. Tuhin attempted to understand this dependence and apply this understanding to designing better tools for detecting and isolating various physics scenarios observed at the LHC. Broadly speaking, one sub-project has been published on the arXiv and submit-

ted to a journal for peer-review, and a second sub-project is in the final phase of completion on this topic.

The first is a paper titled "On Statistical Aspects of QJets," with Stephen D. Ellis (University of Washington), Andrew Hornig (LANL), and David Krohn, <http://arxiv.org/abs/arXiv:1409.6785>. This work analyzes and lays down a framework (namely, QJets), which maps a jet to many clustering histories. They show a way to calculate history-weighted-jet-observables, which are found to be more robust statistically.

Finally, a second sub-project is nearly completely, titled "QNsubjettiness -- how to 'Q' Nsubjettiness." This proposes a new technique in the spirit of 'using clustering histories' in order to construct a more efficient tagger for massive particles using conventional observables such as Nsubjettiness. The findings so far show moderate gains in tagging (identifying) massive particles in a detector. However, since improvements are below original expectation, more work is currently being put into modifying the original proposal.

A second thrust area of Tuhin's current research is to re-examine the 'naturalness principle' in the context of weak scale supersymmetry, which dictated theoretical work for the last few decades of theoretical particle physics. The well-studied Minimal Supersymmetric Standard Model (or MSSM), is generally considered to be the best framework for weak scale supersymmetry. It is, however, heavily constrained since it predicts a barrage of new particles (superpartners) at the electroweak scale, which have not shown up at the LHC yet. Along with Ann E. Nelson from University of Washington, Tuhin constructs an alternative framework where the superpartners are heavy, yet, electroweak physics is natural because of the presence of richer structure of supersymmetry (namely, $N=2$) at the weak scale. A draft of the proposal titled "Generalized Supersoft Supersymmetry" is currently being finalized for submission.

Impact on National Missions

One of the central goals of particle physics and the DOE Office of Science High Energy Physics is to understand the physics of matter at very short distances - 1000 times smaller than the size of a proton - and at energies 100-1000 times higher than the energy in a proton. The recent 2014 P5 report in High Energy Physics recommends that the Office of Science HEP continue to make this effort one of its highest priorities.

Currently the main experimental facility to achieve that goal is the Large Hadron Collider (LHC) located outside of Geneva, Switzerland. This experiment recently discovered a new particle that has the physical features of the so-

called "Higgs boson".

The LHC will begin operations again in 2015, when it will collide protons together at nearly 14000 times higher than the energy in a proton. The ideas developed and published during the course of this project will influence the design of new methods to search for new particles during this upcoming run at the LHC experiment. This project has contributed and will have an impact on this national and international effort to understand Nature at the distance scales being probed by the LHC experiment. Despite its fundamental nature, particle and nuclear science like this project draws talent and develops new approaches to applied nuclear security problems.

Publications

Ellis, Stephen D., A. Hornig, D. Krohn, and Tuhin S. Roy. On Statistical Aspects of Qjets . arXiv:1409.6785, submitted to journal .



Science of Signatures

High Performance Atom-Based Sensors for Fields and Rotations

Malcolm G. Boshier
20130058DR

Introduction

The National Security community needs improved sensors for fields and rotations that advance the state of the art in performance, size/weight/power requirements, and ruggedness. We will respond to this challenge by developing new atom-based sensors for magnetic fields, for gravity, and for rotations. Our approach harnesses unique LANL atomic physics capabilities - the "Painted Potential" for arbitrary manipulation of Bose-Einstein condensate (BEC) matter waves, and high sensitivity atomic magnetometers - in conjunction with the Laboratory's world-class quantum science expertise and its engineering capabilities. We will use the Painted Potential system to create a trapped BEC atom interferometer to measure gravity and (with different programming and detection) a rotation sensor based on an "Atom-SQUID". This new device is a matter wave analog of the well-known superconducting SQUID used for magnetic field sensing. We will also advance the state of the art in magnetometry by pushing atomic magnetometers to their fundamental limits and by combining an atomic magnetometer with the Painted Potential to form a high resolution high sensitivity magnetic microscope. We will develop the theoretical description of these devices and also explore possibilities for quantum enhanced measurement, using quantum correlations to obtain measurement precision which beats the standard quantum limit (shot noise). Most of the size/weight/power requirements in these atom-based sensors are associated with optics and electronics, and so we will engineer those components to minimize their impact on the total sensor package. We will build a prototype atom magnetometer which can operate outside of the laboratory and beat the performance of the best commercial magnetometers by at least an order of magnitude. The outcome of this project will be a new capability which can help meet Intelligence and Defense community needs for improved sensors.

Benefit to National Security Missions

Improved rotation sensors, gravity sensors and magnetometers are of broad interest to many agencies in the Intelligence and Defense Communities. Device applications include respectively inertial navigation, detection of underground structures and of oil or mineral deposits, and the use of power lines for communication and for characterization of activities in inaccessible facilities. The devices based on quantum technologies that are the focus of this project offer potential gains in Size, Weight, and Power (SWaP) and in sensor performance. Theory predicts that the Atom-SQUID we will build should have state of the art rotation sensitivity, in a physics package which is much smaller than the Sagnac atom interferometers which currently have the best performance. A BEC waveguide atom interferometer would measure gravity precisely with a compact device that has no moving parts subject to wear. We will engineer atomic magnetometer technology into a portable device, taking atomic magnetometry from the laboratory to the field.

Finally, while our focus in this project is on applications to sensing, the BEC technologies that we are developing are also very relevant to quantum information processing and hence the Information Science and Technology Mission.

Progress

Boshier and Ryu completed the analysis of our realization of an Atom-SQUID, an analog of the standard superconducting SQUID, that we created by imposing two thin potential barriers on a toroidal trap containing a Bose-Einstein condensate (BEC). We performed extensive computer simulations to confirm that our barriers behaved as ideal Josephson Junctions, which has delivers the advantage that all of the knowledge developed over many years for the superconducting device is can be applied to our superfluid atomic device. This work was published in Physical Review Letters. We also

published a paper showing how the free expansion of a rotating toroidal BEC can be used to create so-called Bessel Beams of matter waves. The Bessel Beam is a particular kind of plane wave, with an amplitude distribution having the form of a Bessel function, that propagates without change in form. In that sense it is diffraction free. One reason why we are developing the Atom SQUID is because of its potential as a compact rotation sensor. We have now performed numerical simulations to design an experiment to show that a property of the Atom SQUID (the so-called critical current, the maximum current that will flow without friction) is a sensitive measure of rotation.

On the BEC theory side, Timmermans has been considering the Atom-SQUID as one of the first quantum devices to be simulated 'from the bottom up'. As a cold-atom architecture, the Atom-SQUID is constructed from superfluid matter of extraordinary delicacy, here a BEC. As an emulation, the experimental conditions have to satisfy physical similarity constraints. He developed a Buckingham-Pi description (involving maximally reduced dimensionless equations) of the system of a single potential induced SQUID-like Josephson junction moving at constant velocity in one-dimensional BEC-circuit. He then worked out the thin-potential limit and developed a Thomas-Fermi description for a slowly varying Josephson potential that allows a direct evaluation of the experimental sensitivity windows. The description reveals that the critical Josephson current is an instability and, therefore, inherently sensitivity.

In the past year Zurek has explored the theory of quantum measurement, and, especially, on the role quantum phase plays in the states of composite quantum systems. His contribution to the 25th Solvay Conference on Physics (W. H. Zurek, pp 54-57, in *The Theory of the Quantum World*, D. Gross et al., eds., World Scientific, Singapore, 2013) is a brief summary of the ongoing project. It discusses the interplay between discreteness and probabilities on one hand, and quantum phases on the other.

The other major component of the the project is the thread on atomic magnetometers. Savukov designed and demonstrated a high-performance compact atomic magnetometer. Light from the two lasers needed to operate the magnetometer was coupled into the sensor head by optical fibers, which allows us to position the lasers far enough from the sensor that magnetic noise from them does not limit the performance of the sensor. This work was published in *Applied Physics Letters*. The magnetometer head was then incorporated into the engineered system being developed by Kwiatkowski and Lindsay. That work has almost reached the point where will have a

portable instrument that can be taken out into the field. In particular a custom electronic control and measurement module has been built, and work has started on developing the software to control the instrument and process the measurements.

Future Work

The project is developing three types of sensor, all based on atomic physics technologies.

In the coming year we will demonstrate that the Atom-SQUID (a BEC in a toroidal trap with two thin potential barriers positioned diametrically opposite each other) can be used as a rotation sensor. Specifically, we will characterize how the so-called critical current (the maximum atom velocity that can flow without friction) depends on rotation of the device, so that we can make predictions about the performance of the device as a rotation sensor. We will extend our quantum theory for the Atom-SQUID.

We will complete construction of a new BEC machine which uses the 39K isotope of potassium. This atom has the useful property that the interactions between atoms can be tuned to zero with an external magnetic field, which is useful for atom interferometry. We will use this system to implement an atom interferometer to measure gravity. A single BEC will be divided into two pieces which sit at slightly different heights above the Earth. Releasing the two pieces of BEC allows them to overlap and form matter wave interference fringes which can be used to measure gravity. We will also perform related theoretical investigations.

Third, we will continue development of atom magnetometers. The engineered atomic magnetometer instrument will be tested in the field, outside of the laboratory. We will continue to study the performance of laboratory atomic magnetometers with the goal of improving their performance towards the fundamental limits set by the laws of physics.

Conclusion

The overall goal of this project is to develop new atom-based sensors for magnetic fields, for gravity, and for rotations that advance the state of the art in performance, size/weight/power requirements, and ruggedness. We will move atomic magnetometers from the laboratory to the field, where they will advance applications ranging from to facility characterization via power line forensics to biophysics. We will start developing cold atom-based rotation sensors that would ultimately realize compact high-performance inertial navigation systems. We will also build gravity sensors with the potential to out-perform current

gravimeters, particularly in applications such as underground structure detection.

Publications

Blinova, A. A., M. G. Boshier, and E. Timmermans. Two polaron flavors of the Bose-Einstein condensate impurity. 2013. *Physical Review A*. 88: 053610.

Campo, A. del. Shortcuts to adiabaticity by counter-diabatic driving. 2013. *Physical Review Letters*. 111: 100502.

Campo, A. del, I. L. Egusquiza, M. B. Plenio, and S. F. Huelga. Quantum Speed Limits in Open System Dynamics. 2013. *Physical Review Letters*. 110: 050403.

Ryu, C., K. C. Henderson, and M. G. Boshier. Creation of matter wave Bessel beams and observation of quantized circulation in a Bose-Einstein condensate. 2014. *New Journal of Physics*. 16: 103406.

Ryu, C., P. W. Blackburn, A. A. Blinova, and M. G. Boshier. Experimental realization of Josephson junctions for an atom SQUID. 2013. *Physical Review Letters*. 111: 205301.

Savukov, I., T. Karaulanov, and M. G. Boshier. Ultra-sensitive high-density Rb-87 radio-frequency magnetometer. 2014. *Applied Physics Letters*. 104: 023504.

Torrontegui, E., S. Ibanez, S. Martinez-Garaot, M. Modugno, A. del Campo, D. Guery-Odelin, A. Ruschhaupt, X. Chen, and J. G. Muga. Shortcuts to Adiabaticity. 2013. *ADVANCES IN ATOMIC, MOLECULAR, AND OPTICAL PHYSICS, VOL 62*. 62: 117.

Zurek, W. H.. Quantum Darwinism, classical reality, and the randomness of quantum jumps. 2014. *Physics Today*. 67 (10): 44.

Zurek, W. H.. Probabilities from entanglement and the origin of quantum jumps. 2013. In *25th Solvay Conference on Physics*. (Brussels, October 2011). , p. 54. Singapore: World Scientific.

Battlefield MRI

Michelle A. Espy
20130121DR

Introduction

We propose to develop a portable “Battlefield” MRI (magnetic resonance imaging) machine based on SQUID (superconducting quantum interference device) sensor technology and ultra-low field MRI techniques developed at LANL. The device will provide a diagnostic quality image in a field deployable package, and use a novel “adaptive” open-coil shield to replace the tons of metal typically required in conventional MRI. The imager will employ very low magnetic fields, which can be completely turned off during transport or when not in use. Most importantly, because the device operates in a fundamentally different regime than a high field MRI machine, it will be able to perform unique imaging tasks that traditional MRI cannot, such as imaging in the emergency room or in the presence of metal. Battlefield MRI will bring the power of MRI to settings where it is presently not possible.

High field (HF) MRI, typically at high magnetic fields > 1.5 T, is the gold standard for diagnosis of mild to moderate brain injury. However, HF MRI is generally not used in emergency situations (emergency rooms or disaster relief), or the battlefield hospital because of the issues of cost and safety associated with high magnetic fields. LANL is a world-leader in the technique of ultra-low field (ULF) MRI for imaging the human brain, ULF MRI operates at pulsed magnetic fields from 100 mT down to 10 microT. Because fields are very low, and can be completely removed, the system is safe to use in the presence of metal, without heating or movement; safe for surgical theaters or emergency situations where the presence of metal nearby or in the subject cannot be precluded.

Benefit to National Security Missions

This effort represents a critical and timely “next step” in LANL’s development of a world-leading capability in ULFMRI and applications. Customers from DHS, DARPA,

and ONR have explicitly issued calls grounded in this capability. This work will provide a rapid medical diagnostic tool for to serve these agencies e.g. disaster/terrorist event response, non-invasive screening. We anticipate a broad range of applications for NIH, e.g. ULFMRI combined with functional methods, fundamental understanding of brain, novel contrast at ULF for new diagnostics and basic biomedical research. We also anticipate significant potential for transition to industry partners. Outside of the battlefield application, the most compelling need for this technology is in developing countries. Sharing our prosperity in health care with the world is a national security interest as well as a humanitarian imperative. NIH may also have interest in MRI for more rural or underserved populations within the US. The technological advances of ULF MRI made here also serve other applications that would benefit from low-cost MRI or novel contrast instrumentation e.g. environmental monitoring (e.g. water or nutrient transport in trees); non-proliferation (non-invasive inspection of materials through pipes or in packaging). The unique contrast of ULF MRI has already served in materials studies including polymer science, and the detection of liquid explosives.

Progress

Progress is described against the tasks and goals for the second year. 1) Sensor array development: Our goal was to upgrade the sensor system to include additional channels required for noise cancellation. This task was completed with the successful implementation of 2nd feedback - a low noise feedback system which keeps the SQUID sensors within their dynamic range and mitigates the effect of pulsed field transients even after 100mT pulsing. The main outcome of our success here is that we are now able to image using the full dynamic polarization capability of our pre-polarization coil. 2) Pulse sequence development: Our objective in year 2 was to demonstrate accelerated imaging via projection imag-

ing and compressed sensing methods. We have developed a compressed sensing algorithm. We are using the multiple channels of the array for image acceleration. We will implement projection imaging outside the magnetically shielded room, as we have experimentally determined that the transients caused by rapid field switching near the magnetically shielded room are quite large and can distort our images. 3) Field Coils and Adaptive Shielding: Our goal in the second year was to test and optimize the measurement and adaptive shielding coils constructed in Year 1 on the V1 system. This has been completed for the coils using a set-up consisting of test cryostats and gradiometers. We will begin optimization with the actual V1 system later this FY (Sept). 4) Version 1 system: A milestone at the Year 1 to Year 2 transition is demonstration of an image from the V1 system. This milestone was completed this June. Results are to be published in two articles appearing in IEEE Transactions on Applied Superconductivity (August 2014) and presented as both an oral and poster contribution at the upcoming Applied Superconductivity Conference. 5) Low temperature Bp development: In year two we have down-selected materials and developed a preliminary design of the V2 Bp coil, achieving our Milestone for the magnet design we plan to move forward with in the V2 (final) system. 6) V2 system: In the second year of the project we also designed and fabricated all upgraded magnetic field generation hardware. A previous task to develop cryocooling has been set aside per mid-year review, so we can focus on the other goals listed above.

Future Work

Year two tasks and goals are: 1) Sensor array development: We will upgrade the sensor system to include additional channels required for noise cancellation 2) Pulse sequence development: We will demonstrate projection imaging and compressed sensing methods that will enable faster data acquisition than our previous linear approaches. 3) Field Coils and Adaptive Shielding: We will test and optimize the measurement and adaptive shielding coils constructed in Year 1 on the V1 system. Based on our results, we will iterate and upgrade the coil design. 4) Version 1 system: A milestone at the Year 1 to Year 2 transition is demonstration of an image from the V1 system. 5) Low temperature Bp development: In year two we will will down-select materials and develop (as required) a bench-scale coil for evaluation. A Milestone in Year 2 is a critical design review of the magnet design we plan to move forward with in the V2 (final) system. 6) V2 system: In the second year of the project we will begin design and fabrication of all upgraded magnetic field generation hardware. A previous task to develop cryocooling has been set aside per mid-year review, so we can focus on the other goals listed above.

Conclusion

The design goals for our proposed system are: 1) a diagnostic quality image as defined by image SNR > 20 and voxel size 2x2x4 mm³; 2) compact system footprint 2x2x2 m³ with open design; 3) infrequent cryogen replenishment, e.g. maintenance interval at >6 months; 4) 20 minute scan time; and 5) production cost of ~\$ 500 k, 10X less than a HFMRI. Key innovations are the use of ultra-sensivite SQUID detection, pulsed-magnet technology, low-noise cryorefrigeration, and an adaptive noise cancellation approach. This approach will enable field-deployable MRI that is presently is not available.

Publications

- Espy, M.. Applications of SQUID Detected MRI. Invited presentation at International Society for Magnetic Resonance in Medicine. (Salt Lake City, Utah, 4-7 April, 2013).
- Espy, M. A., P. E. Magnelind, A. N. Matlashov, S. G. Newman, H. J. Sandin, L. J. Schultz, R. Sedillo, A. V. Urbaitis, and P. L. Volegov. Progress toward a deployable SQUID-based ultra-low field MRI system for anatomical imaging. To appear in IEEE Transactions on Applied Superconductivity.
- Espy, M., P. Volegov, and I. Savukov. Chapter 8 - Hardware Developments: Detection using Squids and Atomic Magnetometers. To appear in Mobile NMR and MRI . Edited by Johns, M..
- Kraus, R. H., M. Espy, P. Magnelind, and P. Volegov. Ultra-Low Field Nuclear Magnetic Resonance: A New MRI Regime . 2014.
- Volegov, P. L., L. J. Schultz, and M. A. Espy. On a ghost artefact in ultra low field magnetic resonance relaxation imaging. 2014. Journal of Magnetic Resonance. 243: 98.

Optical and Laser Spectroscopy of Th-229 Electronic and Nuclear Transitions for the Development of Solid State Nuclear Quantum Sensors

Xinxin Zhao
20140011DR

Introduction

Laser spectroscopy and atomic clocks are at the heart of several very important applications. For example, remote sensing and measurement techniques rely on converting an observable, such as the composition of a Martian rock or the position of a missile or smart phone, into frequency or time signatures that can be measured with the utmost precision and/or accuracy. All atomic clocks have a high quality atomic oscillator, but they differ in the type of oscillator that is used, how the atoms (ions) are isolated from the environment, and the way electronic transition frequencies are detected. Atomic clocks have led to many scientific and technological advances including the Global Positioning System (GPS) for navigation.

The Th-229 nucleus holds the promise of similarly profound impact by using nuclear rather than atomic states. Achieving laser interaction with a nucleus for the first time would dramatically advance the field of “nuclear quantum science and technology” and have transformational impact on fundamental science and sensing. This project builds on our recent breakthrough in Th-229 isomer research and aims for the first-ever demonstration of direct laser excitation of the nucleus. This project is high risk, but the potential payoff is very high because the demonstration of nuclear laser spectroscopy would literally be a “quantum” leap over Mössbauer spectroscopy and enable the realization of a nuclear clock with unmatched precision. If successful, this project would usher in a new era of nuclear quantum science with broad implications from fundamental science to important new applications. Scientists from four divisions (C, P, MST, and T) will contribute their diverse expertise and collaborate on these experiments.

Benefit to National Security Missions

This project lays the foundation for nuclear clock and nuclear quantum technology with transformational

impact in navigation, quantum information, and threat reduction. It addresses LANL Science of Signatures goals: to revolutionize measurement and discovery signatures. It also supports the LANL Materials for the Future Science Pillar by creating novel materials with controlled functionality that advance our knowledge in intrinsic and engineered defects and enable observation of the emergent phenomena of laser-nuclear interactions. A global network of nuclear clocks and the related gravity sensors will be a powerful system for fundamental science, national defense, and threat reduction. LANL is one of only a few institutions worldwide that can assemble a tightly coupled effort combining experimental capabilities in actinides nuclear chemistry (relevant to the weapons program), precision laser spectroscopy, atomic, nuclear and material sciences. LANL has an opportunity to be a world leader in this groundbreaking field. Besides the advanced scientific applications mentioned above, thorium isotopes are also a nuclear “timer” for special nuclear materials. The ultra-sensitive detection of thorium isotopes developed under this DR will have important impact in nuclear forensic applications.

Progress

We have made exciting progresses in all research areas as summarized below:

An accurate wavelength for thorium-229 isomeric transition is required as a first step toward the construction of a nuclear clock or other sensors. We have searched for the transition by collecting thorium-229 recoils following the alpha decay of uranium-233 into MgF₂ plate, and measuring the subsequent light emission using a monochromator. Initial results are very encouraging with 99.9% confidence that we have found the transition. Once confirmed, this advance clears the path for laser spectroscopy of thorium-229 nucleus, and development of a nuclear clock. A paper has been prepared and will be resubmitted to Physical Review Letters.

To understand whether thorium-229 isomer decays via a photon emission or internal electron conversion, we calculated the electronic structures for thorium doped in MgF₂ using hybrid density functional theory and the results show that Th⁴⁺ oxidation state is favored with an electronic bandgap of 9.6 eV. This is ~ 2 eV higher than the energy of the nuclear isomer and greatly suppresses the internal electron conversion de-excitation channel. These calculations also yield the results of electronic transitions of Th³⁺ which we are searching for experimentally. In addition, we have calculated the bandgaps for ThF₄ and Na₂ThF₆, both have large bandgaps that are potential host crystal for thorium-229 nuclear oscillator. A paper was accepted by Inorganic Chemistry.

To achieve laser excitation of thorium-229 nuclear transition, we have constructed and characterized prototypes of the most promising routes to generating the light at the wavelength required to excite the isomeric transition. One promising laser scheme involves 5th harmonic generation of a Ti:Sapphire laser by mixing the 4th harmonic of a Ti:Sapphire laser with a 2nd Ti:Sapphire laser at the fundamental wavelength. This approach will allow us to scan the laser frequency over a broad enough range to search for the nuclear isomeric transition. We have completed the frequency doubling stage with an expected output of 100-300 mW which is sufficient for the 5th harmonic generation. The 5th harmonic generation needs a new crystal either RBBF or KBBF. We have setup a CRADA with Advanced Photonic Crystal (APC). APC will provide the RBBF crystal and we will do the testing and measurement. We are also exploring the possibility of using an LBO crystal to generate a small amount of light for calibrating the monochromator. Laser calibration could reduce the systematic uncertainty of our nuclear optical spectroscopy experiment by a factor of 100.

The laser will be used to excite an ensemble of thorium-229 ions into the isomeric state embedded in a crystal. Most materials however absorb strongly at the expected wavelength of the isomeric transition with the exception of fluoride crystals. Furthermore, the laser excitation will be most effective if a high density of thorium-229 ions is present in the laser focal volume. Thus we will grow small high-quality fluoride crystals that maximize the thorium-229 ion density while making optimum use of the small quantity of thorium-229. Such a crystal growth system is not commercially available. We have partnered with the University of Pisa (Italy) who are leading experts in micro-pulling-down fluoride crystal growth. They have agreed to fabricate an exact copy of their high-performance growth furnace for delivery to LANL in early FY15. The respective contractual framework is currently being put in place. We have

already secured 0.8 mCi ultra-pure thorium-229 for the crystal growth.

We performed absorption and laser induced fluorescence spectroscopy on MgF₂ samples irradiated by thorium-229 and/or alpha particles. Experimental results support the theoretical prediction that the Th⁴⁺ are the most abundant in the crystal. We are currently performing additional measurements to study weak spectral features that might originate from Th³⁺.

Finally, we started theoretical/experimental research on how the oxidation state and/or thorium-229 density affect the isomer lifetime/decay channel. This work will help us to understand the super-radiance effect and the precision of the thorium-229 nuclear oscillator. Better understanding of super-radiance effect would guide the experiment to optimize the parameters for the laser search.

Future Work

- Calculate the charge state and the electronic transitions energies of thorium ions doped in LiCaAlF₆.
- Test laser crystal for 5th harmonic generation. Building the lasers needed to drive thorium-229 nuclear isomeric transition.
- Setup and optimize crystal growth system with thorium-232, and prepare crystal growth apparatus for doping thorium-229.
- Perform theoretical/experimental research on how the oxidation state and/or Th density affect the isomer lifetime/decay channel to get a better understanding of nuclear super-radiance effect.
- Finish the ongoing nuclear optical spectroscopy measurement of thorium-229 isomeric transition and publish the result. Make improved measurement at high resolution and accuracy.
- Finish optical absorption and laser induced fluorescence measurements of thorium electronic transitions and publish the results.

Conclusion

We expect following results with the ultimate goal of achieving direct laser excitation of the nuclear transition.

- Improved accuracy of direct optical spectroscopic measurements to within 0.01 nm or better. This is a prerequisite for the subsequent laser search to succeed.
- Identification of the electronic transitions of the Th ions in the host crystal. This is an unexplored area of

research and will require close collaboration between theory and experiment.

- Preparation of high-quality single crystals doped with Th-229.
- Develop a vacuum ultraviolet laser and demonstrating direct excitation of the Th-229 nuclear transition.

Publications

Ellis, J. K., Wen, and R. L. Martin. Investigation of Thorium Salts As Candidate Materials for Direct Observation of the Th-229m Nuclear Transition. 2014. INORGANIC CHEMISTRY. 53 (13): 6769.

Remote Raman-LIBS Spectroscopy (RLS) Signature Integration

Samuel M. Clegg
20140033DR

Introduction

Distinguishing man-made and natural sources of materials such as actinides can be accomplished from the detection of the molecular and elemental compositions. However, the detection of both molecular and elemental composition is a challenge for any analytical method and it is rarely possible remotely. An integrated Raman and Laser-Induced Breakdown Spectrometer (LIBS) instrument is uniquely capable of remote molecular and elemental quantitative analysis. This proposal will complete the fundamental physical studies required to realize the full potential of this novel integrated approach. The most significant scientific challenge of this project is the development of first principal molecular spectroscopy and plasma physics theoretical models to accurately assess and predict Raman and LIBS spectra, respectively. We will also integrate these theoretical and experimental spectra into a single multivariate matrix from which a self-consistent molecular and elemental quantitative description will be developed. In order to fully realize the potential of this integrated technique, we will prototype the first integrated Raman-LIBS remote sensing instrument capable of detecting actinides such as uranium. Finally, the theoretical models and integrated analysis methods will be validated against carefully designed remote sensing experiments under the most challenging environmental conditions. Consequently, this Science of Signatures project will satisfy all three themes: new signature detection, revolutionize measurement, and forward deployment.

Benefit to National Security Missions

This LDRD DR Science of Signatures project will focus on the detection of actinides which is an element of LANL's core mission. The team will use Raman and LIBS spectroscopy (RLS) to distinguish anthropogenic and natural actinides within complex geological materials as well as the advanced theoretical methods developed in this project. While the strategic focus of this proposal is to

detect actinides, similar RLS instruments and theoretical methods could be used to remotely detect chemical and biological weapons as well as high explosives. RLS can be also used as an in situ analytical geochemical instrument to identify source of soil contamination (i.e. harmful metals) and terrestrially sequestered carbon. Finally, this RLS instrument will be the foundation for future planetary science mission. For the weapons program, we anticipate a new analytical tool for materials inspection.

Progress

Theoretical Calculations

We completed an ab-initio study of the emission spectra from a LIBS-generated Fe plasma. Using modern atomic structure codes and the ATOMIC kinetics modeling code, we have demonstrated reasonable agreement with the measured emission from a sample of iron oxide. This work was recently published in *Spectrochimica Acta B* [Colgan et al, *Spectrochimica Acta B* 97, 65-73 (2014)].

We explored the matrix effects that have often been observed in the emission from LIBS samples of mixed materials. Theoretical modeling has demonstrated that the enhancement of the line intensity observed in a mixed sample is due to the larger electron density found when multiple elements are partially ionized, compared to the electron density generated by a single elemental sample. Our calculations are in good agreement with previously published measurements and we are currently conducting in-house LANL measurements to confirm these findings.

We are also investigating the effect of radiation transport on the observed emission from a LIBS plasma, by numerically transporting the radiation through a number of plasma zones of differing temperature and density conditions.

Development of a F statistical method for detecting and

identifying weak or unresolved LIBS spectra is underway.

We initiated implementation of a highly structured, statistically motivated model for LIBS data that's intended to estimate emission lines in the presence of the Bremsstrahlung continuum, background contamination, absorption due to matrix effects, and data distortion due to the lower resolution of the sensor.

A library of essential Raman spectra has been compiled, and we started preliminary theoretical investigations of Raman spectra.

Clegg gave an invited talk at the 2014 GeoRaman conference on Raman-LIBS Spectroscopy. Clegg and Wiens have been invited to give a talk at the 2014 SCIX conference.

Instrument Development

Developed end-to-end photon budget for three-channel Raman-LIBS spectrometer instrument. We completed the optical and mechanical designs of the transmission spectrometer capable of recording both LIBS and Raman spectra. The commercial parts required for the spectrometer such as the gratings have been ordered. The optical mounts for the spectrometer have been machined.

We completed optical and mechanical design of a custom ICCD detector for the transmission spectrometer and ordered the intensifier and CCD detector. We also completed the TEC cooler integration of the CCD.

Laboratory Investigations

We started preliminary experiments into the remote detection of uranium. This involved the modification, review and approval of an existing IWD. We also completed some preliminary remote Raman experiments using a prototype spectrometer.

Future Work

The project involves three elements that will all continue in FY15 including the Raman theoretical calculations, the LIBS plasma spectroscopy theoretical calculations, and completion of the state-of-the-art RLS instrument. In the second year of this project, the Raman analysis will develop a Raman spectroscopy theoretical library that will focus on naturally occurring uranium minerals. The LIBS plasma spectroscopy will focus on "medium" Z (such as transition metals) elements and continue to develop actinide (high Z) theoretical methods. The team will also complete the construction, integration and testing of the state-of-the-art Raman-LIBS spectrometer suite. This will involve construction of the UV and VIS spectrometers along with the custom built intensified charge coupled device (ICCD)

detectors. Once assembled, a detailed laboratory characterization of the suite will be completed and the end-to-end photon budget developed in the first year will be updated with the as-built values. The combination of the Raman and LIBS theoretical spectra along with the end-to-end photon budget will enable one to simulate the expected experimental observations. We have already initiated experiments on complex actinide containing samples using standard laboratory hardware as an initial validation of the theoretical calculations. These experiments will continue in the second year until the new spectrometer suite is complete.

Conclusion

The overall goal of this project is to develop the theoretical foundations that are capable of predicting and quantitative interpretation of Raman and LIBS spectra. These theoretical models will be tested and validated with the first fully integrated remote Raman – LIBS instrument used to probe actinides doped in complex geological samples. The theoretical methods will revolutionize the analysis of Raman and LIBS spectra within these communities and the instrument demonstration will lead to novel national security and planetary science capabilities.

Publications

Clegg, S. M., Wiens, A. K. Misra, S. K. Sharma, Lambert, Bender, Newell, Nowak-Lovato, S. u. e. Smrekar, M. D. Dyar, and Maurice. Planetary Geochemical Investigations Using Raman and Laser-Induced Breakdown Spectroscopy. 2014. APPLIED SPECTROSCOPY. 68 (9): 925.

Colgan, , E. J. Judge, D. P. Kilcrease, and J. E. Barefield II. Ab-initio modeling of an iron laser-induced plasma: Comparison between theoretical and experimental atomic emission spectra. 2014. SPECTROCHIMICA ACTA PART B-ATOMIC SPECTROSCOPY. 97: 65.

Explosives Signatures for Detection: Nonlinear GHz to THz Responses

David S. Moore
20140049DR

Introduction

This project aims to fill a major gap in our improvised explosive device (IED) detection arsenal, by detecting the explosive itself using penetrating but non-ionizing electromagnetic radiation. This project will develop new experimental and theoretical capabilities to exploit newly-discovered nonlinear coupling of GHz-to-THz electromagnetic radiation to bulk explosives and the detection of the alternative signatures that are generated. The characteristic that we exploit is the intrinsic property that defines an explosive - its metastable chemical energy that can be quickly released on command (by shock, friction, or spark). We will model the expected signatures across relevant length scales from molecular to bulk levels, quantify the complex permittivity versus temperature and amplitude, demonstrate piezoelectric and pyroelectric coupling to convert electromagnetic to ultrasonic energy in situ, and evaluate electro-mechano-chemistry effects. The measurements will be guided and interpreted using electromagnetic theory coupled to strain and heat diffusion, with the ultimate goal to develop fundamental principles that define the processes and signatures, leading the design of a prototype detection system with area-scanning capability from safe stand-off distances. The capability is not intended to be used in isolation, but rather as a tool in the toolset – a tool with drastically improved detection capabilities, viz. penetration through clothing, camouflage, or packaging by using GHz-to-THz frequency radiation, which is a unique electromagnetic spectral region with sparse application to explosives detection.

Benefit to National Security Missions

This project represents a transformational approach to uncovering the direct explosive signal type applicable to the Discover Signatures and Revolutionize Measurement components of the LANL Science of Signatures pillar. The overarching goal of the project directly supports LANL's long-term objective of discovery of the next generation

of materials signatures of explosives within its global security mission. The deep fundamental understanding of energy absorption and subsequent responses are applicable to MaRIE's "Decadal Challenges for Predicting and Controlling Materials Performance in Extremes" for the design and control of energy release in explosives. Work under this proposal will develop a new framework for a unified description of explosives' hot spots coupled to the local mechanical, thermal and electromagnetic signatures. Understanding and controlling the material functionality of defects and crystalline interfaces is important for hot spots and their signatures and underpins the Materials for the Future pillar with the focus area Defects and Interfaces, as well as the priority area 2 for advanced (THz) spectroscopies. The explosive expertise developed in this project is of course highly relevant to the weapons program.

Progress

We have let a subcontract with NIST-Boulder for the measurement of complex permittivity from 20 to 500 GHz. Samples have been sent to our collaborators, including ammonium nitrate and the homemade explosives precursors potassium nitrate, potassium chlorate, potassium perchlorate and ammonium perchlorate. NIST-Boulder added explosives storage and handling capabilities and is now prepared to perform complex permittivity measurements from 20 to 500 GHz on explosives samples, which will be shipped before the end of FY14.

Safety basis and documents to handle explosives were completed and approved for the MPA-CINT THz laboratories at TA-35. Samples of TNT, HMX, PETN, RDX, and CompB were shipped from TA-40 to TA-35 and the THz measurements will be complete by the end of FY14. The samples are also being micro-CT scanned. Samples of AN as well as HME precursors listed above were shipped and the micro-CT scans and THz measurements will be

complete by the end of FY14.

While awaiting the safety paperwork, the explosives simulants 1,3-dinitrobenzene and 1,4-dinitrobenzene were examined by micro-CT and THz spectra were obtained. Theory and modeling have been extended to calculate THz spectra of 1,3- and 1,4-dinitrobenzene to compare to the experimental THz spectra. A paper on this work is in preparation.

The theory and modeling methods used above will be used to calculate THz spectra of the explosives and HME precursors, and compared to the experimental THz spectra obtained. These models are being extended to include the nonlocal temperature fields caused by chemical energy release.

Methodology was established to input micro-CT image-derived FEA models into Abaqus and are working methods for CST and COMSOL. Code was developed to simulate RF electromagnetic field effects on the FEA models of PBX9501 and we have quantified the heterogeneous dissipation of energy. Coding is being developed to extract the corresponding heterogeneous temperature fields.

A waveguide based system was constructed to measure upconverted non-harmonic RF emissions under RF stimulation. The first embodiment utilizes 2.45 GHz sources and waveguides as well as a taper to eliminate the drive frequency, followed by a spectrum analyzer to measure frequency and amplitude of the emissions. The samples listed in the first paragraph are being interrogated.

A Raman spectroscopy system was also constructed to measure the change in Raman spectrum induced by RF stimulation. The first application is using the 2.45 GHz waveguide described above, with stimulation via the network vector analyzer (good to ca. 10 W/cm²). A higher power 2.45 GHz source is available for extension to larger RF fields.

We are also using the Raman spectroscopy system to measure changes in Raman spectrum with static electric fields, wherein the samples are held in a planar geometry double plate capacitor (1 mm sample thickness), capable of electric fields up to 1 MV/m. The static electric field system will be used at the NSLS (Brookhaven) in July to measure changes in the low frequency IR spectrum, as well as at the MPA-CINT THz laboratories.

Future Work

- Task 1: Complete measurement of the complex permittivity of bulk explosives versus temperature and

amplitude from 1 to 100 GHz for the explosives HMX, RDX, PETN, TNT, and ammonium nitrate. Extend to the near-THz regime using open Fabry-Perot resonator methods via collaboration with NIST Boulder (subcontract let June 30, 2014 for two years)

- Extend task 1 to explosives precursors including potassium nitrate, potassium chlorate, potassium perchlorate and ammonium perchlorate.
- Task 2: Complete calculation of constituent effective permittivity tensors for the explosives in task 1 and precursors in task 1a, which will be used to model the frequency and temperature dependent responses of explosives to electromagnetic radiation in the GHz-to-THz frequency regime.
- Task 3: Calculate heterogeneous dissipation of energy and conversion to heterogeneous thermal distributions using Abaqus and/or COMSOL through input of micro-CT derived FEA models of the explosives in task 1 and precursors in task 1a.
- Task 4: Measure Raman and/or far IR (THz) spectral changes with static and RF electric fields and correlate with molecular or crystal structure modifications. Derive mechanistic understanding of the piezo- and/or pyro-electric effects.
- Task 5: Measure upconverted RF emissions from the materials in tasks 1 and 1a using waveguide taper or interference filter methods at 2.45 GHz. Design experiments to do similar measurements at 35 GHz and 95 GHz, pending collaboration or purchase of the high power sources.

Conclusion

The approach described in this project utilizes technologies in frequency regimes capable of penetrating non-metallic packaging, clothing, or camouflage to interrogate bulk explosives, filling a capability gap in the current suite of counter-IED technologies, which includes X-ray imaging, metal detection, trace analysis, intelligence, and persistent surveillance. It will jump-start new modeling capabilities at LANL enabling theory of elasto-electric coupling with chemical energy release at hot spots in explosives. The model development at multiple scales with the combination of coupled matter-energy interactions ranging from the nano to meso scale brings a fresh and new approach to this long-standing problem.

F-Element Nitrides: New Synthetic Methodologies and Signatures for the Preparation of Advanced Nuclear Materials (U)

Jacqueline M. Veauthier
20140066DR

Abstract

Actinide nitrides are becoming increasingly important materials within the intertwined landscape of global energy and security. Historically, these materials have been challenging to prepare pure in bulk quantities. A major impediment to the use of actinide nitride fuels is their synthesis which typically requires temperatures in excess of 1000 °C resulting in carbon and oxygen impurities which changes important properties such as thermal conductivity. This project unites LANL core capabilities in actinide and energetic materials chemistry to investigate innovative synthetic routes to high purity actinide nitrides and to investigate the signatures of materials implemented in these processes.

Background and Research Objectives

Expanding the use of nuclear power is a key component to a successful strategy for a carbon neutral fuel cycle. The 2011 Fukushima nuclear reactor incident corroborates the need for continued innovation in nuclear fuel technologies. Fuel concepts for advanced nuclear reactors include actinide-metals, -nitrides, -carbides, and -oxides. Refractory materials such as actinide nitrides are good nuclear fuel candidates for fast spectrum and accelerator driven reactors, and for transmutation of minor actinides. Indeed, the Japan Atomic Energy Research Institute (JAERI) list nitrides as top fuel-material contenders for its accelerator-driven systems for minor actinide transmutations.[1] Actinide nitrides are ideal materials for advanced nuclear fuels due to their high fissile metal density (approaching that of metallic fuels), high melting points (approaching that of oxide fuels), thermal stabilities, actinide miscibility, and high thermal conductivities (Figure 1).[2] The current synthetic route to nitrides is carbothermic reduction and nitridation (CTRN) from the actinide oxide which requires high temperatures and results in actinide nitride products that contain carbon and oxygen impurities which are known to change important properties including thermal and electrical conductivity.

[3] We have investigated the impact of these impurities on product stability by monitoring the growth of uranium oxide (UO₂) into uranium nitride (UN) prepared by CTRN. Additionally, we have investigated production of nanocrystalline UO₂ foam as a new precursor in the CTRN process to yield high purity UN.

Scientific Approach and Accomplishments

We have prepared three samples of UN using CTRN that have been analyzed for oxygen content in the range of 460ppm to 3200 ppm O. An initial X-ray powder diffraction (XRD) pattern for each sample was collected before the samples were exposed to ambient air and are shown in Figure 2. These XRD patterns show that the samples containing 1200ppm and 3200 ppm O also exhibit signals for UO₂ while the XRD spectrum for the sample with only 460ppm O did not contain XRD peaks associated with UO₂. Next, the 460 ppm O content UN sample was exposed to ambient air and its XRD pattern monitored for the presence of UO₂ and the results are shown in Figure 2. We found that even after exposure to ambient air over a period of 3 months, the XRD pattern of the UN sample did not change - no UO₂ appeared. This indicates that high purity UN samples (460 ppm O or less), prepared by CTRN may be stable to air and moisture for an extended period of time though more experiments are necessary to verify this hypothesis.

We also investigated the production of nanocrystalline high surface area UO₂ (to facilitate production of UN by CTRN). In previous work, we have demonstrated that nitrogen-rich bitetrazolateamine (BTA²⁻) complexes of lanthanides (Figure 3) undergo self-sustained combustion to high surface area lanthanide nitride foams.[4] Thus, we investigated the synthesis of BTA complexes of uranyl (UO₂²⁺). We have found that, indeed, uranyl does coordinate BTA in a ratio of one BTA²⁻ ligand to one uranyl moiety as shown in Figure 4. Next, we found that this uranyl BTA complex also undergoes self-sustained combustion to yield high purity high surface area

nanocrystalline UO₂ foam (Figure 5). Follow-on work will include investigation of the use of this UO₂ foam in CTRN production of UN.

Impact on National Missions

This proposed work has brought together LANL expertise in actinide and energetic materials science, including chemists, theorists, and materials scientists. This work offers new ways to revolutionize production of advanced nuclear fuel materials.

	Oxide (U,Pu)O ₂	Metallic U-Pu-Zr	Nitride (U,Pu)N
Fuel			
Theoretical Density (gcm ⁻³)	11.1	15.9	14.3
Metallic Density (gcm ⁻³)	9.75	14.3	13.5
Thermal Conductivity (Wm ⁻¹ K ⁻²), 773K	4.1	18	15
Melting T(K)	3083	1330	3053

Figure 1. Comparison of nuclear fuel forms.

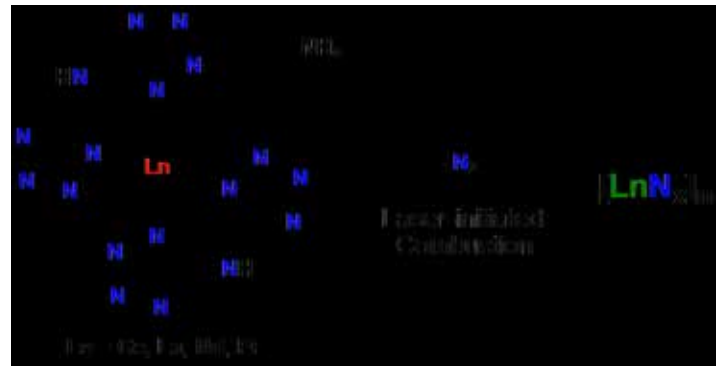

Figure 3. Combustion of nitrogen-rich lanthanide complexes.

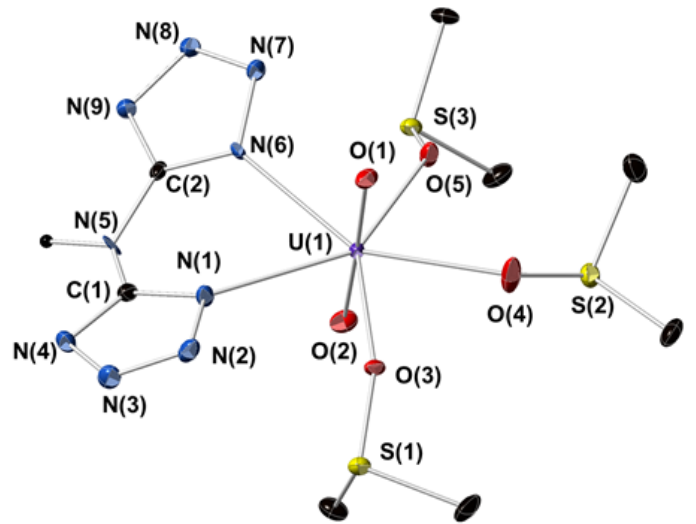

Figure 4. Uranylbitetrazolate amine complex.

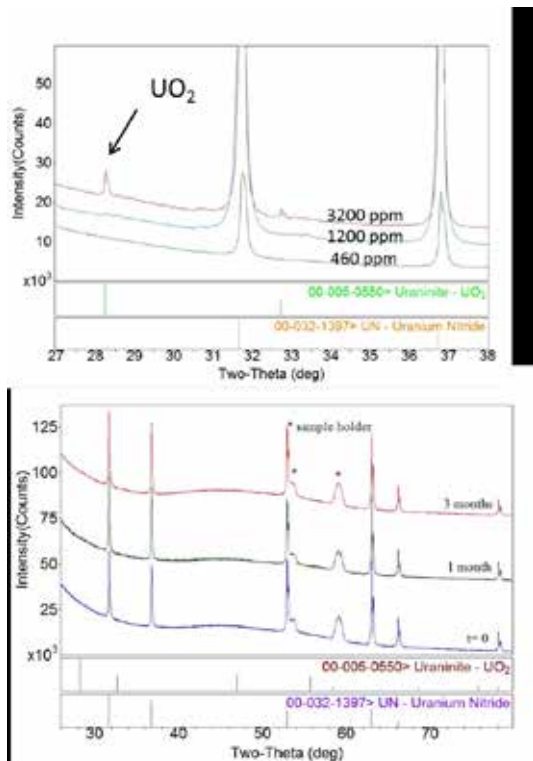

Figure 2. XRD patterns for UN samples with variable O content (top) and for 460 ppm O over three months (bottom).

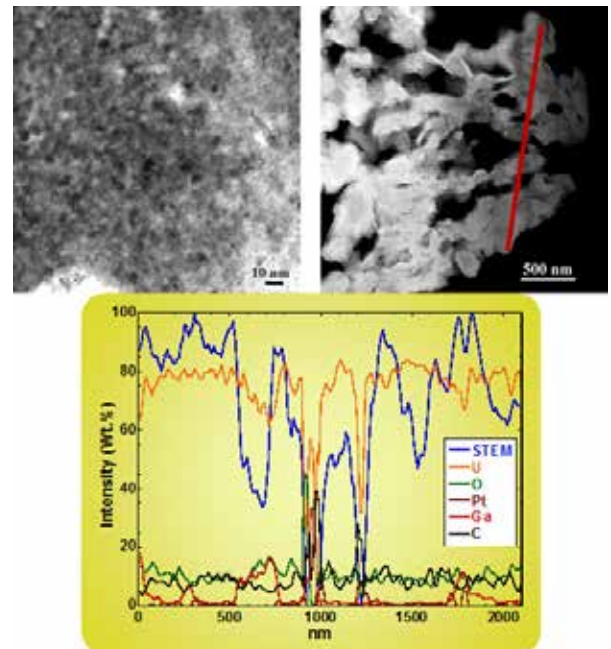

Figure 5. UO foam.

References

1. Arai, Y., and K. Minato. Fabrication and electrochemical behavior of nitride fuel for future applications. 2005. *Journal of Nuclear Material.* : 180.
2. Arai, Y.. Nitride fuels. 2012. *Comprehensive Nuclear Materials.* : 3.
3. Arai, Y., K. Nakajima, and Y. Suzuki. Thermal conductivity of actinide mononitride solid solutions. 1998. *Journal of Alloys and Compounds.* : 602.
4. Veauthier, J. M., B. C. Tappan, A. H. Mueller, and D. E. Chavez. High-nitrogen polydentate ligands for lanthanide/actinide separations. 2009. LDRD report 20090490ER.

Laser-Driven Neutron Source for Detection of Nuclear Material

Andrea Favalli
20140580ECR

Introduction

Los Alamos National Laboratory has pioneered a new short duration yet extremely intense source of neutrons using laser driven targets, with world record beating flux. This offers the potential for an entirely new way of nondestructively assaying (NDA) nuclear materials for safeguards and other purposes. Potential advantages of this neutron source include the tailoring of the neutron energy and angular distribution for particular applications.

The ultimate goal is to develop and optimize the process of neutron production for safeguards and homeland security applications. Pursuant to that goal, this project will perform the measurements needed to establish yield, temporal and energetic characteristics of the neutron beam for different configurations of target/converter (by changing converter/target distance as well different materials): this information is needed for Monte Carlo simulations of future instruments, and is required to address the detection of nuclear material by a laser-driven neutron source. Initially using depleted uranium (DU) this work will use induced fission signatures: specifically neutrons following neutron fission will be detected in a high efficiency neutron counter.

Benefit to National Security Missions

This research directly supports the nuclear security mission. The demonstration of this novel technology and capability will make Los Alamos a world leader in the active interrogation of nuclear materials using laser driven neutron sources. The existence and demonstration of this type of capability is expected to lead to work for existing and new sponsors in safeguards and homeland security. The assay of fuel debris following an accident, such as that at Fukushima, is one example where a bright source of this type combined with the measurement methods discussed might have important practical advantages. Another example could be a very high

throughput interrogation of transporters at ports, as well as in treaty verification. Many more applications and extension to other signatures can be expected, for example the replacement of nuclear reactors used for neutron production at universities.

Progress

Task 1: The first task of the project is to have an experimental campaign at Trident laser facility by the first year of the project. So we have been working in the preparation of the first experimental campaign. We obtained a time at the facility from the last week of August 2014 for three weeks of experiment, and we are working on the process to have permission to move nuclear materials at the facility during the experiments, as well as to prepare detectors and to have our external collaborator, Prof.M.Roth, from Germany, here at Los Alamos at the experiment.

Task 2: Target/convert study. We have been using data from the previous preliminary experiments to extract information on neutron production in the Be ion-to-neutron converter. Although the data set is not extensive, because we had detectors and diagnostics (neutron time-of-flight and ^3He based detector), we are obtaining key information. In addition to delayed neutrons from uranium, the data analysis showed an unexpected delayed neutron tail following neutron peak in the ^3He based detectors. The half-life extracted is found to correspond to delayed neutron production of ^9Li , due to $^9\text{Be}(d,2p)^9\text{Li}$ and $^9\text{Be}(n,p)^9\text{Li}$ nuclear reactions which energy thresholds are 18.42-MeV and 14.26-MeV, respectively. ^9Li subsequently decays, producing delayed neutrons with half-life 178.3 ms. Both the reactions have energy thresholds which indicated that only the high-energy portion of the deuteron ion spectrum impinging on the Be ion-to-neutron converter contributed to the production, consequently we have seen that by monitor the delayed neutron production

from ^9Li we have access to information about the deuteron spectrum and neutron production.

Future Work

Goal: The expected results are the better knowledge of the key parameters for the performance of active neutron interrogation based on short-pulse-laser-driven neutron sources, as well as a better understanding of the physics of all the process from neutron production to interrogation.

Task 1: data analysis/Monte Carlo modeling of the first experimental campaign to identify the key parameters to design the second experimental campaign, both for the set up of the experiment, and for the understanding of detector behavior in a short-pulse laser neutron source.

Task 2: Second Trident Experimental Campaign of active interrogation of nuclear materials by short-pulse laser in Trident.

Conclusion

The expected results are the knowledge of the key parameters for the performance of active neutron interrogation based on short-pulse-laser-driven neutron sources. A better understanding of the physics of all the processes from neutron production to interrogation will be a key benefit of the project. The results will be disseminated by presentations at international conferences and through peer-reviewed papers. The know-how developed will be the guidelines for the engineering of the approach proposed and will be used to write proposals to sponsors such as NA-22, NA-24, DHS and DoD for field applications.

Publications

Goodell, J. J., A. Favalli, M. T. Swinhoe, and J. S. Hendricks. Initial MCNP Simulations of Neutron Production at the Laser-Driven Neutron Source. 2014. Poster Presentation, LANL Student Symposium, 2014-08-05/2014-08-06, Los Alamos (NM, US).

Deployment and Installation Technologies for Distributed Measurement Systems in Inconvenient/Hazardous Environments

David D. Mascarenas
20140629ECR

Introduction

This research aims to develop modular, scalable technologies/capabilities that allow us to deploy and install large-scale, distributed measurement systems in an automated, precise, reliable, cost effective manner while minimizing intrusion into the environment. This capability will be easy to employ from a variety of platforms including commonly available aerial robotics. Emplacing measurement systems in the appropriate environment is generally one of the most challenging and costly aspects of any experimental or field research program, but to date this aspect of technology development has been widely ignored. Manual installation of sensors is still the most common technique to deploy distributed measurement systems. This is particularly problematic when sensors must be located in inconvenient environments such as at heights, in rivers, or in Chem/Bio/Rad hazard areas. The reason for the lack of work in this area is that the development of a lightweight, intelligent remote sensor placement capability that can place sensor nodes accurately and reliably without damaging them in the process is a challenging multi-disciplinary, cyber-physical system research effort. It requires taking into account dynamics, sensor measurement uncertainty, computer vision, projectile dynamics, and embedded systems. This research effort intends to make LANL a technology leader in this largely unexplored field by developing new engineering tools and capabilities that facilitate the large-scale deployment of wireless sensor networks in inconvenient environments. These techniques will be designed with discreetness in mind so that they minimally disturb the environment and avoid influencing the subjects we are trying to study as little as possible. We will develop the high-finesse engineering tools to enable a capability to intelligently, remotely deploy sensor nodes in such a way that when they arrive at their installation site they have enough energy to be installed correctly, but they have a low-enough energy to ensure the sensor itself is not damaged.

Benefit to National Security Missions

This work will strongly support LANL's mission in Global Security, Nonproliferation, and Environmental monitoring. It directly address the Science of Signatures pillar with respect to Forward deployment and it supports the IS&T pillar by providing new data streams for model validation and uncertainty quantification for global climate modeling and energy security. It is inspired by a crosscutting approach to global security mission needs. The work focuses on capability development for environmental sensing and nonproliferation. This work is in particular meant to address needs concerning the loose nuke problem. The team recognize that in order for this effort to have a high impact we must engage with both the LANL community/customers and the broader sensor community to build useful deployment techniques. We will hold a mid-project workshop to get feedback from LANL sensor community and global security program managers on how the work can interface with customer-driven sensor projects. The goal is that this will lead to follow-on collaborations and customer-driven work.

Progress

Since March of 2014, the remote sensor placement project has been brought back online. In June of 2014 we successfully performed a demo of the remote sensor placement system at the Mobisys conference. This is a single-track conference on mobile computing technologies. The demo was well-received. In addition to being accepted to present a demo at this conference, we were also accepted to present a video demo of the presentation. A number of researchers at the conference from academia as well as industry (Microsoft Research) expressed interest in the technology as well as its predecessors. We hope to follow-up with these researchers to look for follow-on projects.

We have also built additional testing apparatus to continue collecting data for this work. We have an addition-

al testing chamber for performing tests to launch sensor nodes in the lab. We also have recently finished building a turret testing fixture test to enable precise testing of the remote sensor placement device in the field. This device allows us to precisely fix the yaw and pitch of the remote sensor placement device during testing.

In addition to this work we also have begun the design of equipment for testing the quadrotor control indoors. The engineering considerations for this experimental apparatus are nearly complete. We are almost ready to show this design to the safety officers for iteration.

Future Work

The main technical milestones for the 2015 fiscal year are as follows:

- Develop control system required to accurately deploy sensor nodes from the aerial robotic vehicle
- Make the second iteration of the multi-shot remote sensor placement device.
- Develop second iteration of the sensor packages and associated attachment mechanisms.
- Perform deployment tests of the newly developed remote sensors. Quantify the accuracy of the sensor deployment.
- Document the work and write it up for peer-reviewed journals. We will also present our work at applicable robotics/wireless sensor networking conferences.

Conclusion

A successful completion of this project will result in solid first step towards a modular remote sensor deployment and installation capability that can be used by the wider sensor networking community. The most important output will be an intelligent, multi-shot, remote sensor placement device capable of being employed from commonly available aerial robotic platforms. We will work toward developing modular deployment packages and characterize a wide array of sensor package attachment mechanisms that can be used to connect sensor packages to a wide variety of materials. Finally, multiple demonstrations of the uses of this capability will be executed.

Publications

Mascareñas, D., L. Ott, A. Curtis, S. Brambilla, A. Larson, S. Brumby, and C. Farrar. Video: remote sensor placement. 2014. In *MobiSys '14- Proceedings of the 12th annual international conference on Mobile systems, applications, and services*. (Bretton Woods, NH, 16-19 June 2014). , p. NA. Bretton Woods, New Hampshire: ACM.

Mascareñas, D., L. Ott, A. Curtis, S. Brambilla, A. Larson, S. Brumby, and C. Farrar. Demo: A remote sensor placement device for scalable and precise deployment of sensor networks . 2014. In *MobiSys '14- Proceedings of the 12th annual international conference on Mobile systems, applications, and services*. (Bretton Woods, NH, 16-19 June 2014). , p. NA. Bretton Woods, New Hampshire: NA.

Next Generation Earth Models

Monica Maceira
20120047ER

Introduction

The main goal of this project is to develop a fast and robust method to derive pictures of the Earth's structure from a combination of four geophysical data sets. Our multi-parameter inversion will produce more accurate Earth models than currently available and will form the basis for the next generation of Earth models. The specific elements of the proposal are to 1) develop an efficient and robust multi-parameter inversion scheme, 2) develop the methodology for pre-processing and weighting the data sets to produce the best image, and 3) develop a detailed, validated model of the Earth's crust beneath the western United States. This project addresses the fundamental problem of creating an accurate image of the Earth, currently a barrier to deeper understanding of the Earth's current state and evolution.

Benefit to National Security Missions

The research will create unique expertise at the Laboratory and will enhance the Laboratory's capability to address core missions in Ground-based Nuclear Detonation Detection within Nuclear Nonproliferation, as well as missions in geothermal energy, geological carbon sequestration, used fuel disposition, and repository science under Applied Energy Programs, Fossil Energy, and Civilian Nuclear Programs. All of these efforts rely on accurate determination and monitoring of Earth structure for success. We also foresee a follow-on LDRD DR aimed at extending this modeling to the global scale using High Performance Computing. The end result would be a world-wide map of strain perturbations for the purpose of earthquake prediction.

Progress

The key accomplishments this year have been:

- Gathering and processing and incorporation of all receiver function data into the inversion. We have also tested the prospect of low pass filtering of the

receiver functions to eliminate excessive noise in some of the receiver functions. While this helps, and allows for inclusion of some additional data constraints, the bulk of the noisy receiver functions are not improved through this approach. This suggests that these data are intrinsically bad and should not be used in the inversion.

- Thorough implementation and testing of the gravity element of our tripartite inversion for crust and upper mantle structure of the western US. I have implemented two types of filtering for the gravity partials, and tested three different velocity/density relationships. So far, shear velocity results from these efforts are very similar, indicating that the inversion scheme is robust and not sensitive to starting models or velocity/density relationships.
- Presentation of our latest results at the American Geophysical Union meeting, 12/2012, in San Francisco.
- Preparation of a journal article showing our joint inversion results using two data types: surface waves and receiver functions.

Future Work

The rest of this fiscal year and the next fiscal year will be spent acquiring and processing the body wave data (the last of the four data types), and performing inversions of all combinations of data types. For the body wave data we will draw on data holdings from our LANL seismic research database. Results will be presented at the annual meeting of the American Geophysical Union and/or the Seismological Society of America meeting. We anticipate finishing and submitting our first paper on joint inversion of surface waves and receiver functions by the end of this fiscal year. We then will write and submit a manuscript on the joint inversion of gravity, receiver functions and surface wave data for the western United States. Following the incorporation of body wave data into the inversion, we will write and submit a paper

on that topic. All papers will be submitted to high profile earth science journals.

Conclusion

The expected results include a fast multi-parameter inversion code for determining high resolution Earth models, a detailed model of the crust and upper mantle of the western US available, and several publications in high impact Earth science journals. The code will be state of the art for several years and will be used throughout the scientific community for understanding the structure of the Earth's crust and mantle. These models will reveal insights into how the Earth's lithosphere is formed and how it evolves over time, with impacts on geothermal resources, disposition of nuclear waste, and global nuclear explosion monitoring.

Publications

Chai, C., C. Ammon, M. Maceira, and R. Herrmann. Inverting interpolated receiver functions with surface-wave dispersion and gravity - Application to the western US and adjacent Canada and Mexico. To appear in *Geophysical Research Letters*.

Lin, Y., E. Syracuse, M. Maceira, C. Larmat, and H. Zhang. Joint inversion for Kilauea volcano with an edge-preserving constraint. 2014. In *Seismological Society of America Annual Meeting*. (Anchorage, 30 April - 2 May, 2014). Vol. 85, p. 502. El Cerrito, California: SSA.

Lin, Y., E. Syracuse, M. Maceira, H. Zhang, and C. Larmat. Double-difference travel-time tomography with edge-preserving regularization and interface prior. To appear in *Geophysical Journal International*.

Maceira, M., C. Ammon, C. Chai, and R. B. Herrmann. Application of advanced multivariate inversion techniques to the western U.S. 2014. In *Seismological Society of America Annual Meeting*. (Anchorage, 30 April - 2 May, 2014). Vol. 85, p. 502. El Cerrito, California: SSA.

Steck, L., M. Begnaud, S. Phillips, and R. Stead. Tomography of crustal P and S travel times across the western United States. 2011. *Journal of Geophysical Research*. 116 (B11304): doi:10.1029/2011JB008260.

Steck, L., M. Maceira, R. B. Herrmann, and C. Ammon. Structure of the lithosphere and asthenosphere beneath the western US from simultaneous multi-parameter inversion. Presented at American Geophysical Union Fall Meeting. (San Francisco, 9-13 December, 2013).

Steck, L., M. Maceira, R. Herrmann, C. Ammon, and R. Stead. Crust and upper mantle structure of the western US from simultaneous inversion of surface wave dispersion, gravity, and receiver functions. 2012. In

Seismological Society of America Annual Meeting. (San Diego, 17-19 April, 2012). Vol. 83, p. 380. El Cerrito, California: BSSA.

Steck, L., M. Maceira, R. Herrmann, and C. Ammon. Structure of the lithosphere and asthenosphere beneath the western US from simultaneous multi-parameter inversion. Presented at American Geophysical Union Fall Meeting. (San Francisco, 3 - 7 December, 2012).

Syracuse, E., M. Maceira, H. Zhang, and C. Thurber. Seismicity and structure of Akutan and Makushin Volcanoes, Alaska, using joint body- and surface-wave tomography. To appear in *Journal of Geophysical Research*.

Syracuse, E., M. Maceira, and H. Zhang. Joint inversion of seismic and gravity data for velocity structure and hypocentral locations at Akutan and Makushin volcanoes. 2014. In *Seismological Society of America Annual Meeting*. (Anchorage, 30 April - 2 May, 2014). Vol. 85, p. 500. El Cerrito, California: SSA.

Zhang, H., C. Thurber, M. Maceira, and P. Roux. Joint inversion of body-wave arrival times and surface-wave dispersion data for three-dimensional seismic velocity structure around SAFOD. Presented at American Geophysical Union Fall Meeting. (San Francisco, 9 -13, December, 2013).

Zhang, H., M. Maceira, P. Roux, and C. Thurber. Joint inversion of body-wave arrival times and surface-wave dispersion for three-dimensional seismic structure around SAFOD. 2014. *Pure and Applied Geophysics*. : DOI:10.1007/s00024.

Wide Field-of-View Plasma Spectrometer

Ruth M. Skoug
20130564ER

Introduction

Through this LDRD-ER project, we will develop and demonstrate a fundamentally new type of space plasma spectrometer (named the “2PS” Spectrometer for 2π -sr) whose field-of-view is nearly 2π -sr using fewer resources than traditional methods. The enabling component is analogous to a pinhole camera having an electrostatic energy-angle filter at the image plane. At the end of this project, we will have an optimized design and thorough understanding of the measurement concept as well as demonstration of the electrostatic energy-angle filter and its performance. The 2PS Spectrometer represents a revolutionary advance for measurement of space plasmas and will realize improved performance with a reduction in required size, mass, and power resources. The concept and operation are intrinsically simple, and enable ultrafast (<0.1 s) measurement of plasma distribution functions to understand, for the first time, the physical processes that drive the complex plasma dynamics of the solar wind and the terrestrial magnetosphere. This breakthrough additionally enables robust plasma measurements on 3-axis stabilized spacecraft and smallsats, which is critical for the Lab’s future national security payloads as well as future scientific missions.

For 50 years, Los Alamos has flown plasma spectrometers for national security payloads as well as NASA scientific missions to study solar wind and planetary magnetospheres such as Earth and Saturn. The Lab has expanded its national security mission into space situational awareness, which entails understanding and predicting the space environment and its impact on the national space infrastructure. The 2PS Spectrometer will enable Los Alamos to continue to lead studies of space plasmas and the space environment, and will position the Lab as an even stronger “go-to” institution for such measurements. We anticipate that this concept may also be the foundation for future generations of national security payloads.

Benefit to National Security Missions

The 2PS Spectrometer represents a revolutionary advance for measurement of space plasmas and will realize improved performance with a reduction in required size, mass, and power resources. It will also, for the first time, enable ultra-fast measurements of plasmas to discover and test hypotheses about physical processes that induce dynamic plasma variations on short time scales. By allowing investigation of processes at short time scales (<0.1 s) this work is thus directly relevant to a number of NASA space science goals, including studies of turbulence and reconnection in space plasmas. For 50 years, Los Alamos has flown plasma spectrometers for national security payloads as well as NASA scientific missions to study solar wind and planetary magnetospheres such as Earth and Saturn. Monitoring and understanding of the space plasma environment is a critical component of the LANL nuclear detonation detection nonproliferation mission. LANL has expanded its national security mission into space situational awareness, which entails understanding and predicting the space environment and its impact on the national space infrastructure. We anticipate that the 2PS instrument concept may also form the foundation for future generations of national security payloads.

The low-resource 2PS spectrometer could also form the basis of a solar wind monitoring instrument for space weather forecasting purposes. While space weather monitoring falls under the purview of NOAA, it is of interest to many agencies (e.g. DOC, NASA, NSF, DoD, DOE, etc.) who together have formed the National Space Weather Program (NSWP) to coordinate efforts in this area.

Progress

Work on the 2-pi Plasma Spectrometer (2PS) project in FY2014 again involved two components: simulation of the instrument concept, and development and testing of

prototype hardware in the laboratory.

Experimental work began with design and construction of a second generation prototype filter plate. This filter plate included cylindrically symmetric slits, a more realistic configuration than the holes used in the first prototype. This second prototype demonstrated the feasibility of manufacturing such slits using wire electric discharge machining (EDM) in a single piece of metal. The relative ease and low cost of the EDM process have greatly facilitated the prototype process. EDM may also provide a way of fabricating a flight instrument, although it is possible that coatings or a return to stacked plates may be required to reduce scattering in the filter plate.

Extensive testing of the second generation prototype was performed this year. This prototype included 4 slots, for detection of particles at 4 different entrance angles. The prototype was installed in a vacuum chamber for testing with an ion beam source. The ion beam source can generate particles from ~ 1 -60 keV, an appropriate range for this instrument. Tests included measurement of the energy and angle response of each slot, and the size and shape of the distribution coming through each slot. Measurements were made using two pinhole plates, first the existing 0.4 mm thick plate, and then with a thinner, 0.1 mm thick pinhole plate. Various measurements of normalizing measurements from the various slots, energies, and angles were investigated.

All laboratory measurements were made using the existing imaging microchannel plate (MCP) system in our test laboratory. While this MCP is too small for a full 2PS instrument, it is suitable for the initial prototype testing. No further investigation of detectors was undertaken, due to budget cuts to this project. The goals of this LDRD project can be fulfilled with existing laboratory detectors. In particular, MCPs and mounting hardware from a previous project are available through our collaborator at the University of New Hampshire (UNH).

In addition to the laboratory measurements, we ran numerous simulations of the instrument. Comparisons between the measurements and simulation results were used to validate the model for use in optimizing the instrument design. Simulation of the slot-based instrument allowed use of 2.5D SIMION, greatly simplifying the model development. With appropriate normalization, the comparison between the model and the prototype measurements does indeed validate the model for further use. The model is able to reproduce the measured energy and angle response to within $\sim 10\%$, good agreement based on the uncertainties in both the measured and simulated data.

Simulation work then proceeded to optimization of the instrument. These studies were performed both at LANL and by our collaborators at UNH. This work is intended to lead to development of a working instrument that can be tuned for a specific application. We investigated modification of the pinhole plate and filter plate thicknesses, and of the distance between the two plates. Reduced pinhole size and pinhole plate thickness lead to better instrument resolution, as does an increase in the thickness of the filter plate. However, in all cases this improved energy and angle resolution comes at the cost of lower count rates. We studied variation of the filter plate slot widths, and determined appropriate widths to give nearly even response across angular range of the instrument. In addition, we found that introducing a conic structure in the center of the filter plate adds a radial component to the deflecting electric field that improves the energy resolution for particles at angles near the center of the instrument. In addition, the increased electric deflection is expected to lead to a reduction in the required deflection voltage, and thus to a reduction in the size, weight, and complexity of the instrument electronics. We continue to study the effects of each optimization, and will use these results to design a final prototype instrument.

Future Work

We will continue testing using existing laboratory position-sensitive microchannel plate (MCP) detectors, rather than the originally proposed crossed-delay-line (XDL) sensors. This change does not affect our ability to optimize the instrument design and prove the instrument concept.

Work during the second year has validated the SIMION model of the 2-pi Plasma Spectrometer, and allowed use of this model in optimizing the instrument design. During the final year of this three-year project we will evaluate the optimizations studied during year two, and will examine the effects of combining various optimized parameters, including plate and slot dimensions and additional structures such as the cone identified in simulations this year. We will continue optimization simulation work to provide the widest possible angular range and the best angle and energy resolution based on geometric factor requirements in various regions of space. The results of these simulations will inform development of a full prototype 2PS instrument. We will design and fabricate a final prototype instrument. This instrument will likely use existing MCP detectors provided by our University of New Hampshire collaborator. We will determine whether wire electric discharge machining (EDM) or stacked plates provide a more suitable filter plate design, and will fabricate a filter plate using the appropriate technology. We will test this prototype instrument in our calibration laboratory using existing

ion and electron beam sources. Assuming optimization and instrument testing continue to be successful, we will explore future flight opportunities for the 2PS instrument.

Conclusion

The 2PS plasma spectrometer acquires a complete measurement with a single high voltage sweep, allowing measurement of a complete distribution function in less than 0.1 sec. These fast measurements will enable study of ultrafast dynamic processes in the solar wind and magneto-spheric plasma environments. The unique design enables a dramatic reduction of resources (mass, power, size, and cost) compared to existing designs. We expect that the mass and power resources will be less than 1 kg and 2 W for one instrument, suitable for use in either cubesat or traditional satellite applications, as well as on 3-axis stabilized spacecraft.

Phase Transitions at Extremes: Emergence of Topological Defects

Vivien Zapf
20130601ER

Introduction

Ever since an early metal worker plunged hot iron into water and discovered quench-induced hardening, the importance of speed in phase transitions was clear. A phase transition is e.g. the process of transforming from solid to liquid or from a non-magnetic to a magnetic state. Phase transitions traversed at extreme speeds are central to many LANL missions. 1st order transitions (which are abrupt and have latent heat,) are well understood and phenomena such as nucleation and annealing are the basis of vast industries. 2nd order phase transitions at extreme speeds (which are continuous and have no latent heat) can also produce profound effects on materials. However, our understanding of 2nd order transitions is incomplete. The Kibble-Zurek Mechanism (KZM) was developed starting in 1985, largely at LANL, and describes how rapid quenching can “freeze in” fluctuations in 2nd order phase transitions, creating defects such as domain walls, vortices, etc. These defects are long-lived fossils of transition dynamics, revealing nature of the fluctuations and the symmetry breaking process. KZM applies to 2nd order phase transitions of interest to LANL and DOE from cosmology to magnets to superconductors.

Recent breakthroughs allow us to test KZM in materials with practical importance. We will study KZM in magnets for the first time in theory and experiment. We innovate by using magnetic fields to induce phase transitions with up to eleven orders of magnitude of quench rate. Thus, for the first time, we can test key quantitative prediction of KZM: the dependence of defect density on quench rate. We build on our expertise in a new class of magnets that have the right symmetry to allow spin vortices and other topological defects, testing KZM in both thermal and quantum phase transitions.

Benefit to National Security Missions

This project seeks to understand the formation of vortices

and other defects in phase transitions out of equilibrium. This is known as the Kibble Zurek mechanism. We will focus specifically on magnetism, thus enhancing fundamental understanding of materials. These topics fall directly within the purview of the DOE Office of Science. However this theory applies to all phase transitions that are traversed rapidly and out of equilibrium. We will be testing the central quantitative prediction of the Kibble Zurek mechanism, and thus we will be making contributions to other fields in which out-of-equilibrium phase transitions are studied including ferroelectrics, charge-density waves, superconductors, cold atoms, and even cosmology. The Kibble Zurek Mechanism was first proposed in cosmology to explain the formation of the early universe. It applies to information science and technology because topological defects are a new frontier for quantum computing, and even in a classical context can be used to store and manipulate data. Understanding how to create and manipulate vortices, both wanted and unwanted, is thus important for fields directly impacting information technology including spintronics, quantum computing, and computer memories.

Progress

We have made significant progress in understanding the dynamics of magnetic and ferroelectric phase transitions.

For ferroelectrics, we have verified the Kibble-Zurek Mechanism (KZM) in the first ferroelectric material to exhibit this effect. The family of materials $REMnO_3$ ($RE = Y$ and rare-earths), synthesized by our collaborators Sang-Wook Cheong et. al at Rutgers University, exhibits the remarkable formation of vortices that vary with quench rate across the thermal phase transition. We have written a paper (under consideration by Nature Physics) in collaboration with Cheong as well as C. D. Batista in T-4 that explains the experimental results.

We have also theoretically explored KZM in the context of correlations between pairs of topological defects. Recent advances on a simple model (developed by Zurek in an article, *J. Phys. Cond. Mat.* vol. 25 (40) 404209, 2013) to account for the winding number in two-dimensional systems through the correlations between pairs of topological defects appears to be fully confirmed by recent experimental data. This justifies re-interpretations of the data of the experiments on tunnel Josephson junctions that are now brought into agreement with KZM.

In magnetic phase transitions, we studied the dynamics of field-induced phase transitions in $\text{NiCl}_2\text{-4SC}(\text{NH}_2)_2$, Ni_3TeO_6 , $\text{Ca}_3\text{CoMnO}_6$, $\text{Ca}_3\text{Co}_2\text{O}_6$, $\text{Sr}_3\text{NiIrO}_6$, $\text{Eu}_2\text{CuIrO}_6$ and CuCrO_2 . Exploiting the unique capabilities of the National High Magnetic Field Lab in MPA-CMMS group, we studied a wide range of magnetic field sweep rates. Using magnetostriction and electric polarization measurements we have ruled out a measurable KZM effect to 10^{-6} precision in $\text{NiCl}_2\text{-4SC}(\text{NH}_2)_2$ and Ni_3TeO_6 . We do, however, observe a colossal magnetoelectric effect in Ni_3TeO_6 , which is published in *Nature Communications*, with a second article in progress.

In $\text{Ca}_3\text{CoMnO}_6$ and $\text{Ca}_3\text{Co}_2\text{O}_6$ we have found exciting dynamic metastable steps in the physical properties that span seven orders of magnitude of sweep rate. The origin of these effects is likely the presence of a large manifold of near-degenerate states due to the frustration in this triangular-lattice compound. The extraordinarily broad range of sweep rates spanning 1 Oe/s to 107 Oe/s allows us to understand the time scales involved for relaxation into and out of these magnetic steps. This is being written up for *Phys. Rev. Letters*. For $\text{Sr}_3\text{NiIrO}_6$ and $\text{Eu}_2\text{CuIrO}_6$, qualitatively similar behavior is observed, however the metastability is strong enough to produce a magnetic hysteresis with record large coercive magnetic field that persists for hours in some samples. This result is being written up for *Nature* and has important implications for the field of hard magnetism.

In the material CuCrO_2 we have explored a cascade of dynamic phase transitions in high magnetic fields between different spiral and other complex magnetic states. Significant dynamics are observed in an oscillating electric polarization, and this metastability is understood through Monte Carlo simulations of equilibrium and non-equilibrium states. This work generated two publications in *Phys. Rev. B* and *Phys. Rev. B Rapid Communications*, as an Editor's Suggestion.

The results have been reported by our team in numerous invited talks - in particular Zurek gave an invited open-

ing lecture (Y32.00001: Universality of Phase Transition Dynamics: Topological Defects from Symmetry Breaking) in the session (Recent Developments in the Kibble-Zurek Problem) at the 2014 March meeting in Denver.

Finally, we have published three significant review articles relevant to this ER in the past fiscal year, on the subjects of the KZM [in proceedings "Symmetry and Fundamental Physics: Tom Kibble at 80", edited by J. Gauntlett (World Scientific, 2014)]; KZM in inhomogeneous settings [*J. Phys. Cond. Mat.* vol. 25 (40), 404210, 2013,]; and Bose-Einstein Condensation in quantum magnets like $\text{NiCl}_2\text{-4SC}(\text{NH}_2)$ [*Rev. Mod. Phys.* 86, 563 (2014)]. The last article appeared on the cover of *Rev. Mod. Phys.*, and is currently the feature article for the American Physical Society webpage (<http://publish.aps.org>).

Future Work

An important goal of FY 2015 is to complete and publish the important work completed so far, including the dynamic magnetic phase transitions, the understanding of KZM in ferroelectrics, and the record hard magnetism in iridate-based materials.

We will also continue to explore the dynamics of phase transitions in experiments and theory building on current discoveries. Of particular interest will be the interplay between spontaneous symmetry breaking and its breaking in presence of finite external bias. We would also like to better understand the extent of the universality of time dependence after the symmetry breaking phase transition.

Conclusion

We expect to test the central prediction of the Kibble Zurek Mechanism that topological defects, like vortices, can be induced by rapidly quenching through 2nd order phase transitions. We will study magnetism and perform the first detailed quantitative test of the power-law scaling of vortex density with quench speed. We will develop the theory for magnets and quantum magnets, and perform experiments in the unprecedented range of magnetic field quench speeds at the National High Magnetic Field Laboratory.

Publications

Campo, A. Del, and W. Zurek. Universality of phase transition dynamics: topological defects from symmetry breaking. 2014. In *Symmetry and fundamental physics: Tom Kibble at 80.*, p. 31. Singapore: World Scientific.

Campo, A. del, T. Kibble, and W. Zurek. Causality and non-equilibrium second-order phase transitions in inhomogeneous systems. 2013. *J. Phys. Condensed Matter.* 25:

404210 .

- Kim, J. W., E. D. Mun, M. Jaime, N. Harrison, J. D. Thompson, H. T. Yi, Y. S. Oh, S. W. Cheong, and V. S. Zapf. Metastable steps in the magnetic, electric and structural properties of a frustrated spin chain compound $\text{Ca}_3\text{Co}_2\text{-xMn}_x\text{O}_6$. *Physical Review Letters* imminent.
- Lin, S. Z., X. Wang, Y. Kamiya, G. W. Chern, G. Fan, D. Fan, B. Casas, V. Kiryukhin, W. H. Zurek, and C. Batista, S. W. Cheong. Topological defects as relics of emergent continuous symmetry and Higgs condensation of disorder in ferroelectrics. To appear in *Nature Physics*.
- Pyka, K., J. Keller, H. L. Partner, R. Nigmatullin, T. Burgermeister, D. M. Meier, K. Kuhlmann, A. Retzker, M. B. Plenio, W. H. Zurek, A. del Campo, and T. E. Mehlstaubler. Topological defect formation and spontaneous symmetry breaking in ion Coulomb crystals. 2013. *Nature Communications*. 4: -.
- Singleton, J., J. W. Kim, C. Topping, A. Hansen, E. D. Mun, S. Ghannadzadeh, P. Goddard, X. Luo, Y. S. Oh, S. W. Cheong, and V. S. Zapf. 55 Tesla coercive magnetic field in frustrated $\text{Sr}_3\text{NiIrO}_6$. *Nature Materials*.
- Torrontegui, E., S. Ibanez, S. Martinez-Garaot, M. Modugno, A. del Campo, D. Guery-Odelin, A. Ruschhaupt, X. Chen, and J. G. Muga. Shortcuts to Adiabaticity. 2013. *Advances in Atomic, Molecular and Optical Physics*. 62: 117.
- Tsyrlin, N., C. D. Batista, V. S. Zapf, M. Jaime, B. R. Hansen, C. Niedermayer, K. C. Rule, K. Habicht, K. Prokes, K. Kiefer, E. Ressouche, A. Paduan, and M. Kenzelmann. Neutron study of the magnetism in $\text{NiCl}_2\text{SC}(\text{NH}_2)_2$. 2013. *Journal of Physics - Condensed Matter*. 25 (21): -.
- Wulf, E., D. Huvonen, J. W. Kim, A. Paduan-Filho, E. Ressouche, S. Gvasaliya, V. S. Zapf, and A. Zheludev. Criticality in a disordered quantum antiferromagnet by neutron diffraction. 2013. *Physical Review B*. 88: 174418.
- Zapf, V. S., B. G. Ueland, M. Laver, M. Lonsky, M. Pohlitz, J. Muller, J. Mira, S. Yanez-Vilar, and M. A. Senaris-Rodriguez. Coupled magnetic and electric hysteresis in the multiferroic double perovskite $\text{Lu}_2\text{MnCoO}_6$. *Physical Review Letters*.
- Zurek, W. H.. Topological relics of symmetry breaking: winding numbers and scaling tilts from random vortex-antivortex pairs. 2013. *J. Phys.: Condens. Matter*. 25: 404209.

Magnetic Nanomarker Detection and Imaging with SQUIDS

Andrei N. Matlashov
20130624ER

Introduction

We propose a revolutionary new technology and instruments for ultra-sensitive magnetic detection and imaging of tissue cells with a detection limit of below 10^4 . By comparison, conventional x-ray mammography requires over 10^8 cancerous cells for detection. Our method will consist of targeting cells using antibody labeled single-core superparamagnetic nanoparticles, followed by detection and imaging of the targeted area using high-resolution Superconducting Quantum Interference Device (SQUID) gradiometers. Superparamagnetic relaxometry (SPMR) is used for detection of targeted cells with very high specificity: Only bonded (immobilized) nanoparticles will be detected via their Néel relaxation. The bonding will occur only with cancer cells because of specific antibodies conjugated to the nanoparticle surface. Unbound nanoparticles will not contribute in the SPMR decay signal. By combining SPMR with ultra-low field magnetic resonance imaging (ULF MRI), using the same instrument, the targeted area will be imaged to provide anatomical information. The same magnetic particles will also work as MRI contrast agents, as they can be detected due to their influence on the relaxation rates of $1H$ nuclear spins, which are an abundant signal source due to the high water content of soft tissue. The combination of ULF MRI and SPMR will provide both accurate localization and cell count of the targeted tissue. SQUIDs enable detection via gradiometers with unprecedented sensitivity. This approach will provide a robust diagnostic tool for detection and localization of diseased (e.g., cancerous) tissue targeted with magnetic markers at a very early disease stage. This technique can be used as an in vivo (inside body) diagnostic. ULF MRI and SPMR measurements have never before been combined in a single device.

Benefit to National Security Missions

We propose here a revolutionary advance in the ability to detect and image very small numbers of labeled cells

or other microscopic objects, with the resolution at least one order of magnitude better than any presently available methods suitable for routine and/or repetitive use. This project illustrates LANL's unique inter-disciplinary ability to develop new instrumentation and measurement technologies.

Two key components are present at LANL – 1) Ultra-high resolution SQUID instrumentation; and 2) Magnetic nanoparticle synthesis and purification, surface modification, and specific bioconjugation.

The combination with imaging provides a truly unique approach to address both the presence and location of labels. The long-term relevance to national security science is both in global health (as an early cancer diagnostic), but also global security (the ability to rapidly detect exposure to pathogens for example, or small quantities of molecules in the environment) and in the capability to provide rare-molecule detection. Success of this project will lead to further development of the method using funds from different agencies such as NIH or, for instance, from DoD Congressionally Directed Medical Research Programs such as Breast Cancer Research Program.

Progress

We significantly improved performances of the seven-channel system that can record ultra-low field magnetic resonance images (ULF MRI) and super-paramagnetic relaxation (SPMR) curves inside magnetically shielded room (MSR). New system configuration includes compensation coils for transients cancellation that significantly improved quality of SPMR signals. Magnetic resonance images can be recorded with 2 mm resolution and 160 mm field of view.

The second seven-channel system has been built that can perform SPMR measurements in unshielded en-

environment outside MSR. This system was tested using phantoms as well as using mice models in cooperation with Senior Scientific LLC (Albuquerque). This new system demonstrates about 10 times better signal-to-noise ratio (SNR) than previously developed systems in unshielded conditions.

A few different phantoms with single and multiple magnetic dipoles have been made in cooperation with Senior Scientific LLC using their new immobilized nano-particles. The phantoms have been tested using two our systems at LANL and one old-generation system at SS LLC. The results is used to investigate accuracy and agreement in magnetic dipole moments recorded by three different systems in different locations and conditions. We are in process of development of new algorithms and computer simulations for inverse problem solution based on SPMR data and using ULF MR images.

Our results will be reported at the International Conference on Biomagnetism, August 2014, Halifax, as an invited oral presentation. Two our posters have been accepted at the Applied Superconductivity Conference, August 2014, Charlotte, and will be published in IEEE Trans. on Applied Superconductivity.

Future Work

During the second year of the project we continued development and improvement of the seven-channel SQUID gradiometer system for interleaved ultra-low field magnetic resonance imaging (ULF MRI) and super-paramagnetic relaxation (SPMR). The system has about 2 mm spatial resolution with 160 mm field of view for MRI. The system is working inside two-layer magnetically shielded room (MSR).

The second seven-channel system was built that can operate in unshielded environment outside MSR. This system was used for SPMR measurements. We are in process of its calibration and data comparison recorded in shielded and unshielded conditions using phantoms. This system has been tested for SPMR measurements in unshielded environment using mice models in cooperation with Senior Scientific LLC in Albuquerque.

We developed a few phantoms with one, two, three and four magnetic dipoles placed in Petri dishes with agarose. The dipoles have been made using immobilized nano-particles manufactured by Senior Scientific LLC in cooperation with the CINT. We are investigating localization accuracy using such phantoms for both SPMR and ULF MRI measurements. New localization algorithms and computer simulations have been performed using phantom data.

Conclusion

We will build instruments and demonstrate a proof of principle that magnetic nanomarker detection and imaging with SQUID-based gradiometers can lead to a creation of revolutionary new cancer diagnostic methods at a very early disease stage. We will 1) demonstrate interleaved ULF MRI and SPMR measurements using a single device; 2) reach $2 \times 2 \times 4$ mm³ ULF MRI system spatial resolution; 3) reach SPMR detection limit of below 10,000 cells; 4) design and build a multichannel system capable of doing measurements in unshielded environment; 5) develop desired optimized superparamagnetic nano-markers; and 6) experimentally demonstrate performance of the method using phantoms and mice.

Publications

Magnelind, P. E., Y. J. Kim,, A. N. Matlashov, , S. G. Newman, , P. L. Volegov,, and M. A. Espy. Toward early cancer detection using superparamagnetic relaxometry in a SQUID-based ULF-MRI system. 2014. Superconductor Science & Technology. Vol. 27: 044031.

Magnelind, P., A. Matlashov, , Y. J. Kim, S. Newman, P. Volegov, and M. Espy. Combining superparamagnetic relaxometry with ultra-low field MRI for early cancer detection. To appear in 19th International conference on Biomagnetism . (Halifax, Canada, 24 - 28 August, 2014).

Matlashov, A., P. Magnelind , H. Sandin, M. Espy , A. Anderson , and H. Mukundan. SQUID instrumentation for early cancer diagnostics: combining SQUID-based ultra-low field MRI and superparamagnetic relaxation . 2013. In Fourteenth International Superconducting Electronics Conference . (Cambridge, 7 - 11 July 2013). , p. 231 . Cambridge: IEEE Xplore.

Matlashov, A., P. Magnelind, Y. J. Kim, H. Sandin, M. Espy, A. Anderson , and H. Mukundan. SQUID-based ULF MRI and superparamagnetic relaxometry for early cancer diagnostics. 2013. Superconductivity News Forum (Global Edition). (25): ST 342.

Electron Capture Spectroscopy for Neutrino Mass: Isotopes, Science, and Technology Development

Michael W. Rabin
20130679ER

Introduction

Measuring neutrino mass is an extremely challenging major science goal with intense current interest. Laboratory measurements of the electron energy spectrum from tritium beta decay set an upper bound for the electron antineutrino mass of ~ 2.2 eV (95% CL), which is only about four parts-per-million of the electron mass. This conventional measurement method will soon reach its technological zenith in the enormous KATRIN experiment with a mass sensitivity of ~ 0.2 eV (by about 2019), but with no hope of significant improvement. Alternative methods are therefore necessary to confirm, refute, refine, or surpass the expected results of this ultimate Goliath of electromagnetic spectrometers. But no known method can do the job today; there are no other sufficiently sensitive, technologically mature methods for laboratory-based, model-independent neutrino mass measurement. Our goal is to develop specific, key science capabilities central and necessary for one of the proposed methods: electron capture spectroscopy (ECS) of the unusual, rare and low decay-energy isotope ^{163}Ho . To determine the neutrino mass, the ECS method requires rare isotope production, radiochemical purification, encapsulation of the Ho inside ultra high resolution cryogenic microcalorimeters (with $\Delta(E) \sim 1-2$ eV at $E \sim 3$ keV), and spectral analysis near the reaction endpoint. To achieve ~ 0.1 eV mass sensitivity, a large-scale, highly demanding ECS experiment will need significant method development, sensor arrays with $\sim 10,000$ pixels, array-compatible readout, and years of operation. Though ~ 0.1 eV mass sensitivity is our long-term ambition, it is well beyond the scope of the present project, and we will limit ourselves to developing key methods necessary for ECS success.

Benefit to National Security Missions

The development of these techniques is directly applicable to basic nuclear physics and nuclear forensics. For basic nuclear physics, the key goal will be to build

consensus within DOE Office of Science for this work using the electron capture spectroscopy technique as a route to determining neutrino mass. As the techniques and capabilities improve, we anticipate this effort will be highly competitive for a major initiative for a large scale experiment for neutrino mass measurement. For nuclear forensics, we are already fully engaged with the US government and the international community. The encapsulation of radionuclides directly into our sensors is a potential new technique for these nuclear materials analysis with special advantages.

Progress

The central long-term challenges of the ^{163}Ho ECS method for neutrino mass measurement are isotope production (nuclear transmutation through purification at scale), high resolution spectroscopy of radioactive decays inside sensors, scaling up to large array-based systems, and complete understanding the nuclear-atomic physics to determine neutrino kinematic mass. There are several common features shared by the worldwide effort to develop the ^{163}Ho -based electron-capture spectroscopy (ECS) method for determination of neutrino kinematic mass. These include ^{163}Ho isotope production, subsequent incorporation of ^{163}Ho into sensors that capture and sum all the decay energy except that of the escaping neutrino, and high-resolution spectroscopy of the summed energy. Scaling up to large array-based systems requires scalable methods and complete understanding of the nuclear-atomic physics to determine the neutrino kinematic mass. Our approach has features that distinguishes it from other efforts pursuing the ECS-based measurement of neutrino mass (ECHO led from U. Hiedelberg and HOLMES led from U. Milan). We are making ^{163}Ho by proton irradiation of natural Dy instead of neutron irradiation of enriched Er. Our method is expected to have a high ^{163}Ho production rate using high-current LANL proton accelerator. The proton-based approach has a predicted factor of 104-

107 lower co-production rate of deleterious interfering isotope (^{166}mHo). Recent measurements by colleagues at U. Heidelberg support this prediction. We are using microcalorimeters whose thermometers are transition-edge sensors (TESs). ECHO is using metallic magnetic microcalorimeters (MMCs). TES multiplexing is significantly more developed. We are experimenting with multiple methods of incorporating Ho into sensors.

By leveraging key LANL capabilities we have made important progress in the past year. We have made, purified and concentrated $\sim 24.75 \pm 1.32$ ng of ^{163}Ho , completely demonstrating an essential and chemically challenging isotope production process. This is a very important result, establishing a pathway based on proton irradiation of natural dysprosium and chemical purification based on high-performance liquid chromatography. We have completed the high-yield microfabrication our first ECS microcalorimeter sensors, with a more robust design for superior embedding of radionuclides. A set of redesigned sensors is under test now to assess performance focusing on improved sensor resolution. All-silicon-body sensors have been tested with a surrogate isotope, ^{55}Fe , demonstrating the most sensitive calorimetric spectrum of this or any electron-capture isotope. These recent experiment show have shown energy resolution of 7.5 eV full-width at half-maximum) FWHM for ^{55}Fe ECS. A second round of proton irradiation underway now using much higher purity Dy target and longer irradiation to improve isotopic purity by factor of >100 . In our most recent experiments, we have seen our first confirmation of ^{163}Ho electron capture decay and initial calorimetric measurement of the decay.

Future Work

We plan to produce high specific activity ^{163}Ho utilizing the IPF at LANSCE. The Ho will be chemically recovered from the target material matrix, leveraging the extensive team expertise at the TA-48 hot cell facility. Purified Ho product will subsequently be converted into aqueous samples suitable for incorporation into microcalorimeters. Detector design, fabrication and testing will begin with our successful TESs, but with intent to optimize for the encapsulation of radioactive materials into very low heat capacity structures. For detector development in year 1, objectives will be demonstrate that we can achieve high resolution spectra and develop the chemical purification process under cold (nonradioactive) conditions. This will allow us to confidently execute a single proton irradiation and a single round of hot cell chemistry in year two.

Having accomplished these objectives, we will work on improving the isotopic purity of the ^{163}Ho , which will be based on improved elemental purity of target (isotopically

natural dysprosium). A primary aim of research during year three will be the continued development of techniques for incorporation of Ho into microcalorimeter absorbers. This is currently the most critical technical challenge. The issues of isotopic purity (residual ^{165}Ho), incorporation of Ho into absorbers, and sensor performance are linked. This linkage was not fully appreciated at the start of this project. We anticipate these issues will be dealt with through a new round of cyclogron-based irradiation (already completed) on higher elemental purity target materials and chemical reduction (to metallic oxidation state) of Ho as part of the absorber fabrication process. Research is active on two general avenues to address oxidation state of the Ho inside microcalorimeter absorbers.

Conclusion

We have three specific project goals. Make ^{163}Ho at high rate with high isotopic and chemical purity. Encapsulate radionuclides, measure ECS with $\Delta(E) \sim 1-2$ eV, at target rate 1000 cps. Use high resolution ECS to measure ^{163}Ho decay energy (Q). An important feature of each of these goals is method scalability, which is what makes sub-eV mass sensitivity possible. A definitive measurement of Q directly addresses ultimate scale required. Combining these results creates an integrated ^{163}Ho ECS capability directly useable with any thermal-type cryogenic detector, independent of thermometer choice, readout method, or multiplexing scheme.

Publications

- Croce, M. P., E. M. Bond, A. S. Hoover, G. J. Kunde, W. A. Moody, M. W. Rabin, D. A. Bennett, Hayes-Wehle, Kotsubo, D. R. Schmidt, and J. N. Ullom. Integration of Radioactive Material with Microcalorimeter Detectors. 2014. JOURNAL OF LOW TEMPERATURE PHYSICS. 176 (5-6): 1009.
- Croce, M. P., K. E. Koehler, G. J. Kunde, M. W. Rabin, E. M. Bond, W. A. Moody, D. R. Schmidt, L. R. Vale, R. D. Horansky, Kotsubo, and J. N. Ullom. Eight-Channel TES Microcalorimeter System for Detector and Source Development. 2013. IEEE TRANSACTIONS ON APPLIED SUPERCONDUCTIVITY. 23 (3).
- Engle, J. W., E. R. Birnbaum, et.al. Evaluation of Ho- 163 production options for neutrino mass measurements with microcalorimeter detectors. 2013. NUCLEAR INSTRUMENTS & METHODS IN PHYSICS RESEARCH SECTION B-BEAM INTERACTIONS WITH MATERIALS AND ATOMS. 311: 131.
- Koehler, K. E., D. A. Bennett, E. M. Bond, et.al. Q Spectroscopy With Superconducting Sensor Microcalorimeters. 2013. IEEE TRANSACTIONS ON NUCLEAR SCIENCE. 60 (2): 624.

Micro-Mirror Full-Frame Programmable Spectral Filters for the Long-wave Infrared

Steven P. Love
20140143ER

Introduction

This project seeks to dramatically improve the speed of infrared spectral imaging. Spectral imaging offers powerful capabilities for detecting and quantifying specific chemicals and materials, with applications from medical imaging to proliferation detection. But traditional hyperspectral imaging (HSI) is intrinsically slow, typically involving “push-broom scanning” a line imager to build up a 2D image, a process that takes several seconds. It also generates huge data sets and requires computationally intensive post-processing to generate a useful final result. These issues limit HSI’s usefulness for fast phenomena, broad-area searches, and wherever bandwidth and data volume are major concerns (e.g. UAVs, satellites). The overarching goal here is to produce a high-specificity spectral imaging capability having drastically (100x or more) reduced acquisition time and data volume, and no need for post-processing.

Over the past two years we have developed a revolutionary new spectral imaging technology based on programmable micro-mirror arrays (MMAs), in which spectral processing takes place directly in the optical hardware. Now proven with working prototypes in the Visible/Near-IR spectral region, it implements background-suppressing matched-filter processing to pull out faint spectral signatures from complex backgrounds, and displays the already-processed results as real-time video-rate imagery. These prototypes, however, have thus far relied on commercial MMAs optimized for high-definition display applications, not spectroscopy. These MMAs are plagued by diffraction effects arising from the small size and tilted configurations of their micro-mirrors. This project seeks to dramatically improve the performance and extend the range of applications of our invention by developing much simpler but spectroscopy-specific 1D “meso-mirror” arrays with two goals in mind: (1) To eliminate, at all wavelengths, the high-loss grating-like diffraction caused by the COTS MMAs’ always-tilted micro-mirrors, and (2) to extend the spectral range to

the application-rich long-wave infrared (LWIR, 8-12 micron) “chemical fingerprint” region.

Benefit to National Security Missions

A fast, low data volume, immediate-answer long-wave infrared spectral imaging capability is of interest to DOE Proliferation Detection, space applications, the intelligence community and DoD. Traditional spectral imaging’s ability to address mission-relevant problems, particularly the detection, identification, and quantification of telltale gases and solids, has been convincingly demonstrated, but its long-standing problems of large data volumes, slow acquisition rates, and slow processing turn-around continue to limit its use in real-world situations. Our new technology addresses these limitations, and its improvements in acquisition speed and data volume, and its near-instantaneous processing turn-around, will enable long-sought capabilities for real-time monitoring of rapidly-changing targets and efficient broad-area searches for hidden targets. Potential targets range from proliferation telltales, to military targets including chemical weapons, to natural gas leaks, to minerals and gases on other planets.

Progress

Progress has occurred along two tracks. First, we have designed and are in the process of assembling and testing a macro mirror array featuring 20 mirrors in a “piano key” arrangement. These mirrors will be used to test the operating principles in the Long-Wave InfraRed (LWIR) and provide proof of principle demonstrations using a LANL-owned LWIR camera. Second, we have designed and fabricated a number of candidate MEMS micro-mirrors for testing and evaluation purposes using the Memscap, Inc. PolyMUMPs process. These are individual mirrors which will be tested and evaluated for suitability in an full-up micro mirror array sized appropriately for LWIR operation. We have also identified a potential commercial partner for producing “piano-key” style MEMS

micro mirror devices that will meet our needs. These commercially available products are very close to what we might want, and we are looking to leverage our in-house expertise to adapt their process to better suit our application.

Future Work

Fabrication of LWIR mirror arrays will proceed on two parallel tracks. First, for proof-of-principle purposes and as a surefire backup, we will build macroscopic versions, with ten to twenty mirrors 2-5 mm wide and about an inch long, driven by conventional electro-mechanical actuators. The primary focus, however, will be on fabricating true MEMS devices, with the individual “piano key” mirrors on the order of 100-500 μ m wide and a few mm long. Initial designs are preceding on both tracks, and we have test devices in hand for development. The macroscopic mirrors are in the final stages of construction and will be ready for table top testing in early FY15. Optical designs for LWIR optics will begin and we plan on utilizing a LANL-owned LWIR camera for prototyping. On the MEMS track, individual micro mirrors have been fabricated for evaluation using a wafer sharing process available from Memscap Corp., known as PolyMUMPs. Based on the results of the individual mirrors, micro-mirror arrays will be designed and submitted for fabrication. We will also be in contact with a vendor of commercial MEMS micro-mirror arrays to determine the potential for sharing wafers during their process, as they appear to be better suited for our needs. Approximate schedule of milestones: Early FY15: 2nd iteration of PolyMUMPs MEMS array tested; mid-FY15: LWIR optical system operational; end-FY-15: spectral selection w/ macro array achieved.

Conclusion

The goal of this work is to produce a high-specificity spectral imaging capability in the long-wave infrared, capable of real-time gas and solid target identification, having drastically (100x or more) reduced acquisition time and data volume compared to traditional hyperspectral imaging, and no need for post-processing. This will be accomplished by means of infrared-optimized micro-mirror arrays that serve as rapidly programmable spectral selectors that perform spectral processing directly in the optical hardware.

Time Resolved Phonon Spectroscopy for Cryogenic Bolometer Readout

Steven R. Elliott
20140200ER

Introduction

As the focus of experimental research moves to rare events beyond the scope of the standard model, it has become increasingly apparent that new technologies with improved background discrimination and reconstruction capabilities are needed to advance the field. Here we outline the first steps of an aggressive push into detector development that seeks to fill the gap that has left particle instrumentation largely divorced from advances in materials science and chemistry. Though bolometers have been successfully operated as sensitive thermometers, the physical phenomena underlying their effectiveness is heat propagation via phonon interactions within the bulk of the absorbing crystal. The details of phonon propagation have not been exploited in bolometric techniques. This proposal details the prerequisites for a program in phonon spectroscopy in radiation detectors with a fast readout device. Demonstrating our ability to measure these underlying processes will open the doors to a precision era in low-energy nuclear physics. In particular, as DOE-NP determines the best approach for a large-scale, double-beta decay experiment, the development of this technology will increase the LANL portfolio of capabilities applicable to that program.

Benefit to National Security Missions

A high resolution calorimeter with good discriminating ability and high throughput has applications that extend beyond a fundamental physics program. By constructing a well counter from high purity macro-bolometers with phonon readout one could perform non-destructive assay of materials extending beyond gamma spectroscopy. At present, a comprehensive assay of a material requires choosing between time consuming counting with a variety of techniques ranging from high purity germanium detectors and barrier silicon detectors which force a compromise between either small active area/long count times or high background; or destructive methods such as mass spectroscopy, neutron activation analysis

or more comprehensive radio-chemical techniques. Developing the capability to monitor materials for all decay products in a single setup will streamline procedures for researchers working in environmental science and the non-proliferation/ treaty verification fields. Perhaps the greatest relevance to non-proliferation programs will lie in the separation of alpha peaks without resort to destructive assay. The detectors might also have higher efficiency but maintain the excellent low-energy x-ray resolution of smaller bolometers.

Progress

Because the focusing effect produces different heat pulse patterns and timing signatures in different materials, detailed simulations are needed to determine optimal sensor placement on crystal surfaces. Many simulation frameworks for particle physics are used, but all focus on scintillation and ionization based detectors. In order to model our detector performance we needed to produce custom routines that would model energy transport in the crystal in the form of phonons, with particular emphasis on the details of their dynamics. Initial efforts have focused on building a software framework to support this simulation campaign. We have made significant progress in reproducing focusing patterns from classic experiments on Germanium using this framework, and are currently gathering data to carry this to other materials, including our favorite, TeO₂. With this new capability, we are in a position to optimize our experimental program and minimize turnaround from measurement to measurement.

The proposed measurement campaign is ambitious and requires us to make a number of innovations as prerequisites. First, we will be pushing the limits of timing resolution in thermal sensor readout using superconducting electronics, and second, we are exploring new territory in fixing transition edge sensors directly to the bulk of materials other than Silicon. In parallel with the simula-

tion efforts, we have been gathering the expertise and developing the collaborations necessary for us to proceed.

Since we plan to test a number of materials with different properties, we need to select a versatile class of heat sensors that are tunable in a wide parameter space. Because we expect the optimal temperature and bias to vary the most from material to material, we have identified AlMn transition edge sensors (TES) as the best choice for our work, and have established a relationship with the developers of this technology at NIST Boulder.

The electronics needed for our studies must interface well with our sensors and greatly influence stray inductance and bandwidth requirements for meeting our timing and energy resolution goals. After consultations with colleagues here at LANL and NIST Boulder, we made contact with an electronics manufacturer (Magnicon) with a product capable of meeting our requirements. These have been ordered and should be arriving in early fall 2014.

Many of the materials we would like to study as detectors require special preparation to avoid impurities, which will affect performance. Some materials, such as TeO₂, enriched with the isotope ¹³⁰Te, can only be obtained from a single producer, and must be procured with care. We have been fortunate enough to develop relationships with collaborators, ex Frank Avignone of USC and Claudia Rusconi of the University of Insubria, who have agreed to get these materials for us. In anticipation of the full TeO₂ crystals, we have obtained some sample wafers, which we have used to investigate surface preparation.

In order to couple the TESs directly to the crystal bulk, the surfaces must be prepared to minimize the separation of the highest peaks and lowest valleys to distances on the order of several nanometers. For semiconductor industry materials such as Germanium and Silicon, this is old-hat and not difficult to achieve. For materials such as TeO₃ however, which do not see regular applications with these standards, some work was required. We contracted a domestic firm Valley Design Corp. to experiment for us, and they were able, with some trial and error, to obtain surfaces that exceed our requirements.

Future Work

The work is planned to take place over three years. During year 1, we plan to complete simulations of the phonon propagation and planning for the major purchases of an initial crystal, transition edge sensors and electronics. Toward the end of the first year and into year 2, we will assemble and begin cryogenic operations.

In year two of our ER, funds will be allocated between an initial measurement campaign and continued development and validation of the simulation framework. Once the dilution unit is in a working capacity and we can reliably cool to working temperature, Johnny Goett and Mark Croce will begin the process of commissioning the electronics that were spec'd out and purchased in year one. Concurrently, Gerd Kunde will liaison with collaborators at NIST to fabricate transition edge sensors and mount them on the surface of Ge and TeO₂ sample crystals. With these two efforts in parallel we should be on track to have functional bolometers mid-year to provide data for the purposes of demonstrating the focusing phenomenon and validating the simulation code. Towards the end of the year, we expect to have gained enough knowledge to prepare multi-sensor TeO₂ crystals to begin assessing the use of the focusing phenomenon as a background rejection technique for low threshold searches.

Conclusion

During the three-year span of this proposed effort, we plan to determine the effectiveness of using multiple sensor readout of a bolometer for energy deposit localization and assess its utility for background reduction.

Measuring Winds in the Stratosphere using Passive Acoustic Sensors

Stephen J. Arrowsmith
20140237ER

Introduction

The fundamental goal of this project is to test the hypothesis that measurements of low-frequency sound from ocean surface wave collisions (microbaroms) recorded by ground sensors at distances of several thousands of kilometers can be used to accurately measure winds in the stratosphere. In a pilot study we have already demonstrated that our methodology can estimate winds in the stratosphere using discrete sources. Following these results we have identified a fundamental opportunity: to apply this inversion methodology to the continuous and ubiquitous acoustic background noise would allow us to measure the evolution of stratospheric winds everywhere without the need of an active source. Three fundamental aspects are required to migrate from a discrete to a continuous source for the inversion: (1) infrasound noise from microbaroms is smaller in amplitude and peaks at lower frequencies than signals from discrete explosive sources; we need to refine our data analysis, (2) we need to validate our inversion results using an independent technique, and (3) we currently have no way to formally quantify uncertainty in our measurements. This project will develop and validate a stochastic method based on inverting low frequency acoustic signals from microbaroms, recorded on ground sensors, to continuously track wind in the stratosphere. We will validate our technique by co-locating a specially-designed infrasound network with a LIDAR system capable of reliably recovering wind and temperature from the stratosphere and mesosphere, which is located in Northern Norway.

Benefit to National Security Missions

The anticipated result from this project is a method, and validation, for measuring winds in the stratosphere using low frequency sound from ocean storms. If successful, we could measure the winds in the stratosphere anywhere over land at low cost with implications for a number of existing programs at LANL. The joint DOE/NSF

Community Earth System Model (CESM) is one of three US IPCC-class climate models in which LANL personnel in T-3 and CCS-2 currently play an active research role. The CESM model includes a whole atmosphere configuration that goes up to the thermosphere. Of particular interest for the stratosphere dynamics are effects on the ozone layer, which plays a key role in radiative interactions as well as gravity wave drag (a sub-grid scale phenomena that plays an important role in atmospheric dynamics). Furthermore, the opportunity of direct wind measurements in the tropics may be particularly important, where the thermal wind equation is known to work poorly. Our results also have implications for the NASA program and warfighter support and have potential implication for improving GPS accuracy through improved correction for stratospheric effects. Improved specification of atmospheric winds also has an important implication for Global Security: since knowledge of stratospheric winds affects the propagation of infrasound signals our results can improve infrasonic location and yield estimation of nuclear tests and improve the prediction of dispersion of radioactive aerosols, which can reach the stratosphere.

Progress

We have made significant progress in the last nine months since this project began. These are summarized below.

Three infrasound arrays were deployed in central New Mexico between December 2013 and April 2014. The arrays were deployed in a line to include an array operated at Sandia and the network of arrays was designed to enable us to explore the optimum inter-array distance for measuring the correlation of ocean-generated infrasound.

We performed extensive analysis of the data retrieved from the New Mexico deployment. Our analysis is

ongoing but has found that there are periods of strong microbarom (ocean infrasound) signals at all arrays, that we can observe correlations up to at least ~35 km, and that we observe highly-correlated wind farm signals at at least three arrays. Our findings suggest that wind farms may also be utilized to probe the atmosphere and we are currently writing a short article on the preliminary findings from this experiment.

To supplement the data analysis performed using New Mexico arrays, we are beginning to analyze microbarom signals in Southern California, using arrays operated by colleagues at UCSD, and to analyze microbaroms in Norway in preparation for our proposed field deployment there next winter. Understanding the global variability of microbarom signals and the spatial-temporal variability in proposed experimental regions is important to the success of this project.

To complement the experimental research we are also modeling the propagation of infrasound over long distances from microbarom sources using both geometric and full-wave methods. This task is providing important synthetic data to complement the experimental data as it enables us to explore the effects of array offset on inversion performance and to validate our inverse methodology.

We have begun to explore the mathematical development of improvements to our inversion methodology (developed under an early-career LDRD project) to enable us to use a Bayesian formulation. This refined approach will enable more detailed estimation of the uncertainty in our upper-atmosphere wind measurements.

Future Work

In Year 2 of this project we will complete the analysis of existing experimental data from New Mexico deployments and data from existing arrays in Southern California and Norway. We anticipate an additional small sensor collect to optimize our design based on these analyses in October, November 2014.

We also plan to complete a modeling study of the propagation of infrasound over long distances from microbarom sources, using both geometric and full-wave methods, that was begun in Year 1.

The major effort in Year 2 will be the preparation and deployment of an extensive network of infrasound arrays, with associated data analysis and application of our inversion methods, currently planned for deployment in Norway during the wintertime. We have begun preparing for this work and plan to collaborate with Gerd Baumgarten (IAP),

Steven Gibbons (NORSAR) and Roger Waxler (University of Mississippi) as discussed in the proposal.

Further developments on the inversion methodology developed under this effort will continue to be made as data are analyzed and processed.

It is anticipated that two peer-reviewed journal articles will be submitted on this work during Year 2.

Conclusion

The main expected result is a validated and operational ground-based technique that is capable of providing measurements of wind in the stratosphere from measurements of the continuous and ubiquitous acoustic background noise. This technique can be exported anywhere on Earth and does not require a known source, enabling us to track the wind continuously. We envisage this research to provide material for several peer-reviewed publications. As our main research result will be truly innovative and transformational, we expect our research to be suitable for a high-profile broad-audience journal, i.e., Nature or Science.

Cryogenic Laser Refrigerator for Infrared Imaging

Markus P. Hehlen
20140275ER

Introduction

Airborne and space-based infrared (IR) imaging is a critical technology that delivers essential information to important fields as diverse as agriculture, climatology, and treaty verification. InSb or HgCdTe are common IR sensor materials for the mid- (3-5 μm) or long-wave (8-12 μm) atmospheric windows. These detectors have to be cooled to cryogenic temperatures (near 77 K) to sufficiently reduce thermal noise. Currently, the only available options for cooling are mechanical (Stirling, pulse tube, reverse Brayton), thermo-electric (TEC), or liquid cryogenes. Practical TECs only cool to 175 K, and liquid cryogenes are unsuited for long-duration and space missions, making mechanical coolers the current technology of choice. Despite significant progress in damping compressor vibrations, mechanical coolers impart microphonic noise to the detector by exciting lightly damped resonant modes in the sensor assembly being cooled. This causes the image to blur. Microphonics is the major factor limiting image resolution. In fact, the mechanical cooler is turned off during image acquisition in some satellite IR imaging systems, which is a highly undesired mode of operation because it carries significant risk of system failure during repowering. Microphonics also substantially limits the energy resolution of cooled high-purity germanium (HPGe) radiation detectors. Laser refrigeration of solids is the only cryogenic cooling technology that is inherently vibration free because it is based on the all-optical process of anti-Stokes fluorescence. Our goal is to design, build, and test – for the first time – an infrared detector that is cooled to 80 K by a vibration-free laser refrigerator. If successful, this would represent a critical engineering milestone and open the door for application of this technology to a wide range of mission-relevant problems.

Benefit to National Security Missions

Laser refrigeration of an infrared detector to 80 K would constitute a major breakthrough in cryogenics. It will

have far-reaching implications for remote sensing in a wide range of mission-critical applications. By eliminating vibrations, infrared systems will be able to achieve their full image and spectral resolution. This will significantly enhance the information quality in hyperspectral, astronomical, and planetary missions. Furthermore, removing vibrations in the infrared camera payload will make it more likely for infrared technologies to be selected to share a satellite and will thus advance the overall capabilities of remote sensing platforms. These benefits are of immediate interest to a range of mission-critical programs in proliferation detection (DOE NA-22), space situational awareness, reconnaissance applications (DoD, IC), and earth, planetary, and astronomy missions (NASA). LANL Program Managers for DOE Proliferation Detection Programs, Emerging Threats, and NASA Programs are aware of our efforts and will be involved as the technology matures and reaches a level for involvement of customers.

Progress

The lowest temperatures and/or the heat lifts that can be achieved with a solid-state laser refrigerator are currently limited by the chemical purity of the laser-cooling crystal. Previous studies suggest that transition-metal impurities such as Fe, Co, Cu, Ni, V, Cr, etc. are primarily responsible for the undesired internal heating that limits the performance. Therefore, the focus of the first 8 months of the project has been on developing the process for purifying the precursor chemicals (YF₃, LiF, YbF₃) that are used for the subsequent growth of a YLiF₄:Yb laser-cooling crystal. We have completed a first purification series for each of the three precursors using a chelate-assisted solvent extraction process that was carried out in the tightly controlled environment of a Class 100 clean room. It involved dissolving the respective commercial high-purity metal carbonate, ultra-filtration of the solution, addition of a chelating agent that preferentially binds to transition-metal im-

purities, and extraction of the respective impurity-chelate complexes from the aqueous into an organic phase. The process was repeated five times followed by the final precipitation of the respective metal fluoride. Two types of chelating agents were tested. The impurity concentrations were then measured at each step along the process using inductively-coupled plasma mass spectrometry (ICP-MS). We found that the levels of the most problematic impurities (Fe, Co, Cu) could indeed be reduced to below 1 part-per-million for the yttrium and lithium precursor using an ammonium-pyrrolidine-dithiocarbamate (APDC) chelate, while the purification of the ytterbium precursor was less effective. In parallel, we have made rapid progress in developing an alternative purification technique that is potentially much simpler and more scalable than the labor-intensive chelate-assisted solvent extraction process. It involves reducing transition-metal impurities in aqueous solutions by electrochemically plating them onto a glassy carbon electrode. First ICP-MS results from this electrochemical purification method are expected by the end of June. This will be followed by purification of sufficiently large amounts of YF₃ (160 g), LiF (40 g), and YbF₃ (30 g) precursors that will be used for the subsequent Czochralski growth of a YLiF₄:Yb laser-cooling crystal by the commercial vendor AC Materials in July/August. In parallel, we are preparing a set of precursors that have not undergone the purification process and that will be grown into a YLiF₄:Yb reference crystal. This will allow us to quantitatively assess the effect of precursor purification on the laser-cooling performance. Our collaborators at the University of New Mexico will test both crystals by the end of this FY to meet our Year 1 milestone.

During this reporting period we have also made substantial progress in developing a comprehensive engineering model for an optical refrigerator device. The model includes the properties of the laser-cooling crystal, the optical parameters of the cavity, and the geometry and thermal properties of all components. The model then predicts the laser-cooling power of the crystal as well as the various heat loads from the surroundings, and it allows calculation of the heat lift that is available to cool a payload. This model is a first step towards designing a laser-cooled detector device in Year 2 of the project.

We have also presented our results at conferences and in the literature. This included invited oral presentations by the Principal Investigator (PI) at the Laser Refrigeration of Solids conference at SPIE Photonics West as well as the Emerging Cryogenic Coolers session at the SPIE Defense Sciences Symposium (DSS). Both presentations were accompanied by papers in the SPIE Proceedings. The DSS presentation was a particularly successful as the conference

organizers have decided to initiate a new session dedicated to laser cooling in upcoming DSS meetings, which will be a prime venue to interface with potential customers of this new technology. The PI has also written an invited 85-page chapter entitled Solid-State Optical Refrigeration for the prestigious Handbook on the Physics and Chemistry of Rare Earths (Vol 45, Ch 265, in press). Another paper co-authored by the PI has been published in the IEEE Photonics Society News. Our work has also attracted substantial interest by the National Reconnaissance Office (NRO) during their multiple visits to LANL this fiscal year. NRO may be an early customer of the technology that is being developed in this project.

Future Work

The work in Year 2 of the project (FY15) will focus on designing, constructing, and testing a laser-cooling device that utilizes a high-purity YLiF₄:Yb laser-cooling crystal produced in Year 1. Some material development, potentially including another crystal-growth run, will take place in parallel during the first half of FY15.

The main tasks will include (1) completion of the device model, (2) selection of an IR detector chip (payload to be cooled), (3) mechanical, optical, and thermal design of the laser-cooling module, and (4) fabrication and testing of the integrated laser-cooling module. The goal is to cool the semiconductor payload (IR detector) to 80 K with a heat lift of 5-10 mW. The lowest temperature and the available heat lift can be traded off against each other, and the best operating point for the chosen detector chip will be found based on the model and experimentation.

We will present the results at conferences and in the peer-reviewed literature. We will also continue and strengthen our interactions with potential customers in order to ensure continuation of the development and to explore commercialization opportunities.

Conclusion

We expect to fabricate a high purity ytterbium-doped yttrium lithium fluoride (YLF:Yb) crystal to enable laser cooling of a commercial infrared sensor chip to 80 K with a cooling power of 5-10 mW. The level of purity will be assessed by measuring the crystal's absorption coefficient, with the goal of reaching a value of $2 \times 10^{-5} \text{ cm}^{-1}$ or below. The crystal will be integrated into a custom-built cryogenic IR detector prototype. The project deliverables are (1) a laser-cooled infrared detector prototype and (2) quantitative assessments of the YLF:Yb crystal performance, the minimum detector temperature, and the IR detector thermal noise.

Publications

Epstein, R. I., M. P. Hehlen, M. Sheik-Bahae, and S. D. Melgaard. Optical cryocoolers for sensors and electronics. 2014. Proceedings of SPIE. 9070: 90702K.

Epstein, R. I., M. Sheik-Bahae, and M. P. Hehlen. Optical refrigerators outshine thermoelectric coolers. 2014. IEEE Photonics Society News. 28: 9.

Hehlen, M. P., M. Sheik-Bahae, R. I. Epstein, S. D. Melgaard, and D. V. Seletskiy. Materials for optical cryocoolers. 2013. Journal of Materials Chemistry C. 1 (45): 7471.

Hehlen, M. P., M. Sheik-Bahae, and R. I. Epstein. Solid-state optical refrigeration. 2014. In The Handbook on the Physics and Chemistry of Rare Earths. Edited by Buzzi, J. C.. Vol. 45, p. 179. Waltham, MA: Elsevier.

Hehlen, M. P., W. L. Boncher, S. D. Melgaard, M. W. Blair, R. A. Jackson, T. E. Littlewood, and S. P. Love. Preparation of high-purity LiF, YF₃, and YbF₃ for laser refrigeration. 2014. Proceedings of SPIE. 9000: 9000.

Matter Wave Circuits

Changhyun Ryu
20140362ER

Introduction

The goal of this project is to create the de Broglie wave analog of an integrated optical circuit, a device that might be called a matter wave circuit. In this technology, coherent atomic matter waves from an integrated source are guided and manipulated in confining potentials in much the same way that laser light propagation is controlled in a waveguide photonic circuit. The push to develop matter wave circuits is motivated by several important differences between matter waves and light waves: atomic velocities can be controlled over a wide range; atoms can be brought to rest and trapped; atoms feel gravity and electromagnetic fields; atoms can interact strongly with each other; and atoms can be imaged with high efficiency. These characteristics enable matter wave circuit applications to sensing (particularly interferometry) as well as to quantum information processing, quantum atom optics, and emulation of transport problems in condensed matter systems. This promise motivates our proposal to realize the first matter wave circuit. We will confine de Broglie waves from a Bose-Einstein condensate (BEC) in waveguides and manipulate them with optical elements, all created using LANL's unique "Painted Potential" capability. This technique creates arbitrary and dynamic time-averaged optical dipole potentials compatible with the very low energy of a BEC.

Benefit to National Security Missions

Atoms lie at the heart of some of the best technologies for measuring time, detecting rotations, and processing information on quantum computers. The atom optical technology developed in this project supports Laboratory missions in Sensing, because the atom circuit technology is relevant to rotation sensing, and in Information Science and Technology, because matter wave technology in general is relevant to quantum information processing. These applications in sensing and quantum information processing are of interest to external sponsors in the intelligence and defense communities.

Progress

In the first year of the project we demonstrated all of the key elements of a matter wave circuit by using our Painted Potential technology to create patterns of overlapping laser beams that realize waveguides which can confine atoms moving inside them.

First, we created an analogy of the tunable laser source in an optical circuit by launching a Bose-Einstein condensate (BEC) into a waveguide circuit. The BEC was initially created in a short section of straight waveguide. By altering the intensity of the laser creating the waveguide trap as it scanned back and forth, we caused the bottom of the trap to slope downwards. The BEC accelerated down this slope until it reached a desired velocity, launching the matter waves into the circuit, analogous to the launching of light from a laser into an optical fiber. Second, we propagated the matter waves around a waveguide containing a 90 degree bend, the first time this has ever been accomplished. Here the main issue is to avoid coupling energy into higher transverse modes as the potential curves. By measuring the increase in the width of the BEC as it passed around the bend we were able to determine that the occupation of the ground state in the guide was about 92%, meaning that we demonstrated almost single mode propagation around a bend. We then combined four 90 degree bends to realize a square closed waveguide with curved bends and launched the BEC around it so it made a complete circuit.

Third, we sent the BEC through a Y-junction, demonstrating that it could be split into two parts. By altering the intensity ratios in the two arms we could control the BEC fraction sent down each arm. By switching the intensity ratio as the BEC propagated through the junction we created a switch, sending the front of the BEC down one arm and the back of the BEC down the other. After the BEC had been split, we turned off the trapping potentials, which allowed the two parts of the BEC to expand, overlap, and form matter wave interference fringes.

From the position of the central fringe we were able to determine that the splitting was phase coherent. The fluctuations in the relative phase had a standard deviation of about 30 degrees. This experiment was the first demonstration of any kind of division of a guided BEC

guides for matter-waves: supersymmetric potentials and reflectionless geometries. 2014. Scientific Reports. 4: 5274.

Ryu, C., and M. G. Boshier. Integrated matter wave circuits. Physical Review X.

Future Work

In the first year of the project we have demonstrated the launching of Bose-Einstein condensates (BECs) into straight, curved, and closed loop waveguides. We have also demonstrated phase coherent splitting of the guided BEC. One task for the second year will be to improve the performance of these circuit elements. We will investigate both theoretically and experimentally non-circular bends as a strategy for reducing transverse excitations of BECs negotiating bends. We will also seek to understand the source of the observed phase fluctuations between the two arms of the Y-junction and then look for ways to reduce them.

Next we plan to develop mirrors for matter waves. One can use a simple potential barrier with appropriate height to reflect (or transmit) matter waves. However this form of mirror/beamsplitter is not very useful because its reflectance and transmittance vary rapidly with de Broglie wave-length. The solution to this problem is well-known from traditional optics: replace the single potential barrier by a periodic array of weaker potentials. This is the basic principle of multi-layer optical coatings and of distributed Bragg reflectors. We plan to realize this type of mirror by including a modulation on the painted waveguide potential. We can tune the wavelength of the matter wave to map out the reflection/transmission properties of such a device using the usual atom imaging diagnostics. An obvious next step is combining two such reflectors on the same guide to realize a matter wave cavity.

Conclusion

The overall goal is to demonstrate for the first time analogs of optical fibers and integrated laser sources with cold atoms. Specific technical goals include: (1) launching coherent matter waves into a single mode of a non-trivial waveguide geometry at controllable speed, (2) demonstrating the matter wave analog of a distributed Bragg reflector, and using two such optics to create a matter wave resonator, (3) demonstrating a “Y” beamsplitter by adiabatically deforming a single waveguide into two guides. Success will deliver new levels of control over atoms to important applications in sensing and information processing.

Publications

Campo, A. del, M. G. Boshier, and A. Saxena. Bent wave-

Chemical Shift Signatures of Nuclear Material: ^{235}U and ^{239}Pu NMR Spectroscopy

Michael T. Janicke
20140396ER

Introduction

The crux of this research is the development of low frequency Dynamic Nuclear Polarization Enhanced Nuclear Magnetic Resonance spectroscopy (DNP-NMR, imagine a MRI instrument for chemistry studies with 1000 times increase in signal to noise). DNP-NMR spectroscopy will be a tool for detection of ^{235}U and ^{239}Pu chemical shift signatures, monitoring the origin, fate and transport of these contaminants, and the bioavailability of such species in the environments. Much of this project will focus on ^{239}Pu but work will be easily extended to the more challenging ^{235}U in relation to using NMR as the most steadfast method for differentiating and quantifying molecular species.

This proposed research project will demonstrate that we can increase the sensitivity without increasing the sample size or experiment time and get the equivalent sensitivity to a commercial multi-million dollar instrument for a fraction of the cost. We will accomplish this by using DNP-NMR. At LANL we have demonstrated use of DNP at very low magnetic fields (10 mT) without cooling the samples to liquid helium temperatures via the Overhauser effect. In this approach, electrons spin transfer to nuclei is enhanced by microwave irradiation. Using this method we achieved ~ 100 -fold polarization enhancement, followed by NMR signal readout at very low frequencies. A published system also based on relatively low magnetic field and without cooling the samples to liquid helium temperatures has been demonstrated for the relatively easy ^1H isotope for roughly \$100,000. However this system cannot measure low frequency nuclei such as ^{235}U and ^{239}Pu . With this low-cost instrument, the research group is achieving ^1H enhancements of greater than ~ 100 , as well. Combining the DNP with our demonstrated expertise at ultra-low field we anticipate for ^{235}U and ^{239}Pu the signal improvement will be >1000 -fold compared to routine NMR techniques.

Benefit to National Security Missions

Plutonium has one of the most complex chemistries of any element. The sheer diversity and unique chemical properties that Pu exhibits are ideally suited for Nuclear Magnetic Resonance (NMR) and for this reason this project aims to develop a new chemical signature, the ^{239}Pu NMR chemical shift. Chemical shift is the change in NMR signal frequency from a known standard set at 0 ppm arising from local magnetic fields produced by the electron distribution. In effect it is a direct measure of the bonding environment around specific nuclei and gives rise to the sensitivity of NMR chemical shift spectroscopy to chemical species. Analytical methods such as elemental analysis or detection of fission products (neutron, gamma, or beta) do not reveal the chemical species or its origin. Complex samples with multiple species cannot be analyzed using traditional methods such as Extended X-ray Absorption Fine Structure analysis, as they will inevitably have overlapping results that require precise use of model compounds and accurate computational methods for deconvolution. NMR presents us with the most accurate and quantitative method where differences in species will result in distinct chemical shifts. But due to the complexity of ^{239}Pu NMR and plutonium chemistry, the NMR signature of ^{239}Pu was only published in May of last year. This same basic technique can be expanded to include additional chemical, nuclear, and environmental threats that have chemical signatures and NMR active elements including ^{13}C , ^{15}N , ^{19}F , and ^{31}P and numerous heavy metals.

Progress

- Assembled a low field nuclear magnetic resonance spectrometer (NMR) as a demonstration, proof of principle, and feasibility study. This low field instrument is currently operating and measuring the magnetic resonance signal for ^1H from water. Dynamic nuclear polarization (DNP) capability is about to be installed at which point we will shift gears and begin

nuclear polarization from the free radical TEMPO. Upon demonstration of the 1H capabilities, the instrument will be tuned to lower frequencies to analyze environmentally important isotopes such as 19F, 31P, 35Cl, and 14N.

- Recognizing the need for a higher field instrument than our low field spectrometer that is currently running, the team has acquired a NMR spectrometer from B Division and the property has been transferred. This acquisition has saved the team some capital expense and given us access to commercial instrumentation and software that is currently supported.
- The need exists for standard samples with which to test and benchmark our DNP-NMR. Our project is geared towards analyzing low frequency isotopes such as 239Pu and 235U. Within this range, we have found 89Y to be a suitable surrogate and high field NMR (9.4 T) measurements have been conducted to support this project.
- As mentioned, 239Pu is the ultimate chemical signature for which the team is aiming. But as proof of principle, the team is joining with the Seaborg Institute in using standard 239Pu solutions in high field NMR experiments as validation of future DNP-NMR chemical shift signatures. As the final spin 1/2 isotope on the periodic table for which a NMR signal has been measured, this task has been very challenging and still ongoing. Challenges have been with the limited work available for plutonium under the current work pause and instrument issues associated with low frequencies.
- The project is also being solicited to other funding opportunities for postdoctoral support to build a larger team with varying expertise to be successful.

Visiting Task 1: Build platform for detecting Nuclear Magnet Resonance (NMR) signature of chemical species (non-radioactive surrogates) with similar properties to 239Pu. These can include 41K, 75As, 107Ag, 197Au and 207Pb, decisions will be made based on NMR frequency and solubility. This system would leverage extensively from existing hardware (magnets, coils, Apollo console, etc.) and could be used to baseline sensitivity of the approach. Design and construction months: 1-6; testing and validation months: 6-12.

Focusing on 1H for demonstration, we are on schedule at month 8 with system testing currently underway.

Visiting Task 2. Test and optimize NMR instrument for 239Pu using known PuO2 sample. Validate and extend results with conventional high-field NMR (LANL or PNNL) and

new system (i.e. methods for handling short T1; methods for increasing temperature from 4K to room temperature). The advantage of this approach is significant reduction in magnet cost, complexity, and expense. Further, the compatibility with microfluidics means sample preparation and delivery can be done “on board” and without significant handling and sample minimization. High field NMR validation months: 1-6; Signature extension/ measurements in new system Months: 12-24.

There has been a bit of delay with the availability of a 239Pu sample and high field validation studies began at month 6. Due to budget restraints, microfluidic demonstration will probably be dropped from the project as other groups at the Laboratory have interest and funding for that addition.

Future Work

In the first year we will have completed our first task, construction of our platform for detecting Nuclear Magnet Resonance (NMR) signature of chemical species (non-radioactive surrogates) with similar properties to 239Pu. We are on track for this.

In the second year of the project we will focus on Tasks 2 and 3 defined in the proposal. Task 3 will extend into the third year of the project.

Task 2: Test and optimize our NMR instrument for 239Pu using a known PuO2 sample. We will validate and extend results with conventional high-field NMR (available at LANL or PNNL) and our new system (i.e. methods for handling short T1; methods for increasing temperature from 4K to room temperature). The advantage of this approach is significant reduction in magnet cost, complexity, and expense. Further, the compatibility with microfluidics means sample preparation and delivery can be done “on board” and without significant handling and sample minimization. High field NMR validation months: 1-6; Signature extension/ measurements in new system Months: 12-24.

Task 3: Develop protocol for dynamic nuclear polarization enhanced NMR (DNP-NMR) for sensitivity increase. This task includes instrument development and identification of free radical species for polarization transfer (ie. 2,2,6,6-Tetramethylpiperidin-1-yl)oxyl referred to as TEMPO, a water soluble, stable free radical benchmarked in many DNP-NMR studies) Months: 18-30.

Conclusion

The lower bounds of the frequency range for metals might not be reached; however, there are other organic com-

pounds containing ^{13}C , ^{15}N , ^{19}F , and ^{31}P that will be made accessible for DNP-NMR analysis that do not have these complications and have equal if not greater need for detection and forensics for chemical and biological agents. In other words, if we are not successful in analyzing metal speciation, the instrument will already have succeeded in measuring important organic compounds. Additionally, if we meet the challenges above, we will have an R&D 100 candidate, commercialization and licensing possibilities, and a portable instrument.

Solid-State Gamma-Ray Detectors Based on Quantum Dots

Jeffrey M. Pietryga
20140406ER

Introduction

The threat posed by the proliferation of illicit Special Nuclear Materials (SNM) is especially grave as they carry the potential for disaster in dangerously small packages. Hidden SNM can be found and identified by detection of the characteristic gamma radiation it emits, but this type of screening becomes quite complicated in real scenarios. Detectors at high-traffic border crossings, for example, must be able to distinguish SNM from a range of benign gamma-ray sources that are a part of ordinary commerce by determining the energy of gamma-rays with high precision, while sampling a large area at a very high rate of throughput. Unfortunately, current technologies cannot meet this need. We propose to develop a new class of solid-state gamma-ray detectors based on cheap, solution-synthesized semiconductor nanocrystals that will offer a new standard in combined performance, low-cost and adaptability.

In this project, we will fabricate gamma-sensitive diodes based on semiconductor nanocrystals synthesized by low-cost, scalable chemical methods. Although these nanometer-sized bits of semiconductor materials exhibit extremely useful size-tunable electronic and optical properties, for most of their history nanocrystals had been considered ill-suited to applications in electronic devices (like diodes) because of the difficulty in achieving high electrical conductivity when they are assembled into thin films. Recent developments have cast that perception aside, and there are now numerous ways to make device-ready conductive films of nanocrystals that exploit their unique properties without sacrificing their advantages in cost and scalability.

We propose to extrapolate this recent progress to an unprecedented degree to enable a new class of gamma-ray detectors. We will then probe their response to high-energy radiation, and optimize both the nanocrystals and the architecture to maximize energy resolution, with the ultimate goal of realizing performance on a par with

current, much more expensive and less scalable technologies such as single-crystal gamma scintillators.

Benefit to National Security Missions

The guiding goal we have chosen for this work is to make gamma-radiation detectors that are comparable to gamma scintillators in energy-resolving performance, but much cheaper and easy to scale to portal-relevant detector sizes. The tie to nonproliferation-involved agencies, as well as to any other agencies (Defense or Intelligence) interested in detecting the presence of nuclear materials, is clear. The flexibility of our new detector class would easily make them adaptable to needs in nuclear reactor/facility monitoring, and radioactivity-related environmental remediation efforts. It is quite likely that specific needs of space science (gamma spectroscopy) and satellite surveillance could ultimately be met by the proposed class of detectors. Such sensors could also be of interest to materials scientists for use in various types of radiography, and to the medical field as cheap, superior replacements for current detectors used in x-ray, nuclear, and positron emission tomography (PET) imaging techniques. Finally, because this research will advance the understanding of achieving high conductivity in nanocrystal films, it will also likely have incidental benefits to current efforts in high-efficiency solar cells and solid-state lighting based on nanocrystals.

Progress

Our three-year goal is to create a new class of gamma-ray detectors based on colloidal semiconductor nanocrystals, or quantum dots (QDs). These chemically synthesized materials feature a unique hybrid inorganic-core/organic-shell structure that, for the first ~20 years of their study, was considered to be a serious barrier to their use in electronic devices. The underlying contention of this project is that recent and ongoing advances in the fabrication of highly conductive films based on colloidal QDs (through which carrier mobilities have

increased by over 6 orders of magnitude) have made the concept of a solid-state QD-based gamma-ray detector feasible. However, because the majority of research into conductive QD films has been motivated by solar photovoltaics (for which film sub-micron film thicknesses are fully adequate for photon collection), there are no known examples of attempts to produce and study films capable of stopping gamma rays (at energies of 100's of keV, which can require millimeters of material). Because stopping gamma rays is the first necessary step of detecting them, pushing the limits of film thickness is one of the biggest fundamental steps of this project. Accordingly, in our original plan for the first year, our intention was to investigate the amenability of a range of current film preparation techniques (such as sequential dip- or spin-coating, or electrophoretic deposition) to production of films 2-3 orders of magnitude thicker than previously reported.

While such efforts have begun and continue, discussions among researchers with expertise in QDs and gamma-ray detectors, respectively, led to a slightly modified approach that would make better use of the full diversity of the team while still addressing issues of fundamental importance to the operation of QD-based detectors. It was fully realized at the beginning of the project that developing increasingly thick conductive films without engagement of members of the team who were expert in gamma-ray detector design would be a mistake, so before new films were even prepared, the QD researchers provided the detector team typical QD devices made for other purposes, even though they were much too thin for practical use as gamma detectors. These were used to construct a basic apparatus for measuring response to radiation. Indeed, once a method for contacting these devices was determined, it was verified that no measurable response was observed to a low-activity americium source. However, an x-ray tube used as a source of a much higher flux of lower-energy photons did result in a measurable photocurrent. This was an important outcome, as it proved that, as expected, there are no physical barriers to the transduction of high energy photons into conductive carriers that produce a signal. Even so, when discussing these results, and how they informed our next steps, it was quickly realized that a better course of action would be to maintain a focus on studying device response under conditions that will produce single capture events. This would not only allow us to derive a better understanding of the fundamental energy conversion process (i.e. how many electron-hole pairs are created per unit of photon energy, and how long does it take to collect the charges), but would also be much truer to the ultimate application for these devices, which ultimately will need to operate in single-event counting mode. In order to mitigate the problem of the low gamma stopping power of the

currently achievable films, we would employ sources of charged particle radiation (e.g. alpha particles, beta particles) instead of gamma sources. Such particles are much less penetrating than gamma rays, but can deposit similar amounts of energy in single capture events, allowing us to probe device operation principles in parallel with our ongoing efforts in thick-film preparation.

For such studies, it was decided to use a quasi-hemispherical device geometry, which features a laterally large bottom contact (millimeters to centimeters) coated with the QD active layer, and a top contact as small as possible (~50-100 microns). This device should produce the simplest possible collection signatures (which will be observed with a fast oscilloscope). Currently, several 1 micron-thick devices are being prepared by conventional dip- and spin-coating for these studies, and we are determining the suitability of ultrasonic wire-bonding for preparing the top contact.

Future Work

As described in the progress summary, in the first year, the decision was made to apply a parallel approach that will allow film-preparation efforts to proceed alongside studies of the fundamentals of device operation. Thus, the next fiscal year will still include continuing efforts toward producing conductive quantum-dot (QD) films with thicknesses up to 10's and 100's of microns. Increasingly, we will need to diverge from current methods that iterate QD deposition with treatment with conductivity-enhancing chemicals (such as 1,2-ethanedithiol or hydrazine). While repetitive approaches are suitable for solar cells, for which the number of iterations is on the order of 20, they are not really feasible for going 2-3 orders of magnitude thicker. Thus, we will increasingly focus on conductivity treatments that are performed completely before deposition, such as the use of inorganic ligands, combined with fast deposition methods like electrophoretic deposition.

At the same time, we will expand upon the soon-to-be started device studies using charged particle radiation as a stand-in for gamma radiation. By varying the radiation source, we will still be able to not only establish the efficiency of collection under varied biases and detector geometries, but will also be able to assess whether we can discern information about the total energy deposited in each capture event. This is important, as we ultimately envision our detectors being used in energy-resolving applications. Because these two efforts are proceeding in parallel, we anticipate that the quality of data produced by device studies will continuously improve as we continue to produce thicker and more conductive films as active layers. In turn, the device data will inform each successive generation of films, allowing us to efficiently discard the least

promising film fabrication methods.

Conclusion

In order to create the first gamma-sensing diodes based on nanocrystals, we will need to make very thick conductive nanocrystal films in order to capture radiation effectively. Then, we will extensively characterize how simple devices based on these films respond to radiation of a range of energies, which would be a seminal accomplishment for this completely new category of sensing technology in itself. Finally, we will optimize the nanocrystals and the device structure with the goal of achieving performance comparable to common gamma scintillators, and potentially to other types of radiation detectors used in medical imaging or materials science.

Agile Persistent SSA Surveillance Networks Using Mobile Platforms

W. T. Vestrand
20140425ER

Introduction

In the 21st Century, with nearly 40 nations operating space missions, Space has become, in the words of former Deputy Defense Secretary William J. Lynn III, “congested, contested, and competitive”. This fact is forcing significant re-evaluation of the military Space Situational Awareness (SSA) community’s practices. We are developing a new approach that employs persistent surveillance to recognize SSA threats and opportunities as they emerge and marshals real-time interrogating observations with autonomous robotic follow-up instruments. The central focus of our research is answering the question---“How do we achieve effective full sky persistent surveillance when faced with the reality of highly cost constrained budgets?”

The existing SSA persistent monitors are located at a few, land-based, fixed locations that are highly constrained by geopolitics. As a result, most satellites are not monitored most of the time. To fill this gap, we will engineer inexpensive full-sky persistent SSA surveillance systems that can operate autonomously from moving platforms like ocean-going ships and allow agile deployment in an integrated global network. Each system will collect space object track information, share observations to facilitate anomaly detection, and accept tasking for specific objects of interest. Global distribution provides favorable illumination conditions, timely access to space objects, redundancy to weather outages, and fault tolerance. Our approach has the potential to cost only a few percent of traditional radar-based space fence systems and provide global passive persistent surveillance of the entire sky.

Benefit to National Security Missions

The congested, contested, and competitive nature of Space in near earth orbit is driving an urgent National Security need for persistent surveillance of the full night sky. But the existing Space Situational Awareness (SSA) monitors capable of persistent surveillance are located

at only a few, land-based, fixed locations in the Northern Hemisphere that are highly constrained by Geopolitics. As a result, most of the night sky is not monitored most of the time. We will develop an innovative approach that could fill this SSA knowledge gap through the use of an integrated, global, persistent surveillance network employing small, full-sky, optical/IR monitors deployed on mobile platforms. Our effort aims to solve three salient engineering challenges that pose a barrier to practical application of this approach: (1) Development and demonstration of hardware and software modifications to LANL designs for stationary SSA monitors to enable accurate geo-registration and real-time onboard analysis on moving platforms; (2) Development of robust persistent monitor hardware that can be deployed in harsh conditions like those present on Ocean-going ships; and (3) Development of tools for determining optimal sensor placement to augment the existing Space Surveillance Network.

Progress

Last year we completed the construction of a single imager test-bed with tilt sensors and Global Positioning Sensors (GPS) for deployment and testing on moving platforms. Prototype software was integrated with the imager test-bed platform and mounted in the bed of a government pick-up truck. Night time testing was then conducted to explore the operation and the accuracy of derived star position during moving operation. This study helped clearly define the requirements for imager stability and real-time geo-location and is guiding the design of the full instrument stabilization platform. While ocean deployment is beyond the cost scope of our current program, our testing will be designed to mimic the motion and vibration challenges that would be posed by deployment aboard a ship.

The one minute response time for effective LEO SSA, large data rate for the surveillance imagery (1 TByte/

sensor/night), and very limited communication bandwidth (< 2 Mbit/sec) forces most of the processing to be done at the sensors in real-time. To meet this requirement on the moving platform, we started modifying our analysis pipelines to ingest continuous updates of the sensor location. This new software combines real-time GPS measurements with a real-time astrometric pipeline code that achieves spatial registration through a triangle matching scheme which compares observed stars to a reference star catalog.

We also completed the engineering of a new sensor enclosure that is designed to protect the hardware in a marine environment. Our previous designs had been optimized for high altitude dry environments—good astronomical sites. For the challenges posed by the corrosive marine environment, this year we developed sealed optical windows for the telescopes, new robust enclosure hatches, and a new design for a closed circuit temperature regulation system. The new sensor enclosure prototype was milled, assembled, and tested. G-code for Computer Numerical Control (CNC) milling was developed and a set of final production units were fabricated.

The third major accomplishment of our effort this year was the development of new software to help quantitatively assess the utility of persistent surveillance locations. The new software allows the geographic locations of the sensors to trace the paths of mobile platforms. The new tools also allow simulation of site uptime, viewing frustum, and limiting magnitude for each sensor in a distributed network. We also developed tools that will allow the optimization simulations to incorporate the actual orbits, illumination geometry, and the measured brightness of known satellites. When complete, this simulation suite will enable optimal deployment of assets within a global network, especially as an enhancement to the Space Surveillance Network of the United States.

Future Work

In this final year of our effort, we will construct and test the full monitor prototype. Our focus will be on the integration of the new software with the new stabilized platform to demonstrate the feasibility of conducting real-time persistent surveillance from moving platforms. Night time testing will be conducted to establish mobile operation and the accuracy of the SSA spatial and photometric measurements. Our testing will be designed to mimic the motion and vibration challenges that would be posed by deployment aboard a ship.

We will also complete the simulation suite and conduct simulations that will allow us to quantitatively assess the utility of persistent surveillance from moving platforms.

Our work will incorporate the properties of real satellites from spacetrack.org to simulate the effectiveness of global deployment of our persistent monitoring platforms. Our goal is to explore the trade space associated with the number of sensors and global spatial distribution of sensing platforms. We also plan to work closely with collaborators at AGI (a leading commercial provider of SSA solutions for the US Government) to explore how moving sensors can enable new approaches to cost effective Space Situational Awareness.

Conclusion

We will solve three salient engineering challenges that pose a barrier to practical deployment of sky-full persistent monitors on moving platforms: Development of hardware and software modifications to enable accurate geo-registration and real-time onboard analysis; Construction of environmentally hardened persistent SSA surveillance monitors that can be deployed in harsh conditions like those present on ships; and Development of tools for determining optimal sensor placement to augment the existing SSN (Space Surveillance Network). Our success with optical monitors on moving platforms will demonstrate the feasibility of continuous surveillance of essentially all operating satellites in LEO—the most rapidly changing orbital regime.

Signatures of Reactor Operations from Plutonium Production Samples (U)

Anna C. Hayes-Sterbenz
20140433ER

Introduction

This project is to quantify a novel scheme for using fission product ratios to determine detailed reactor operations used to irradiate nuclear material. We are proposing to analyze a very unique set of irradiated reactor samples and to use our measured fission product ratios to validate the scheme. The samples in question were part of a plutonium production-testing program. Our goal is to show how fission product ratios can be used to determine the reactor flux, the irradiation time, as well as the number of times the reactor was shut off during irradiation. As detailed below, the key ratios of interest are the xenon isotopes and their decay products, $^{135}\text{Cs}/^{137}\text{Cs}$, $^{103}\text{Ru}/^{106}\text{Ru}$ (and their decay products $^{103}\text{Rh}/^{106}\text{Pd}$), and $^{85}\text{Kr}/^{84}\text{Kr}$. The project is a joint experimental and theoretical one. The experiments will concentrate on measuring the relevant fission product ratios using analytic chemical techniques and mass spectroscopy. The theoretical program will derive semi-analytic prescriptions for extracting the signatures for the reactor operation parameters. The results will be compared with the reactor operations declared by the facility that provided the samples. The coupling of the two components (experimental and theoretical) of the project will provide the necessary quantitative validation that is needed for practical use of the scheme in scenarios ranging from pre-detonation forensics to monitoring of reprocessing facilities.

The ability to extract reactor flux, irradiation times, and shut downs from fission products would

- Greatly narrow the possible reactors used to irradiated fuel, in the case of seized nuclear material.
- Determine the grade of plutonium and identify undeclared nuclear blankets, in the case that fission products were released in fuel reprocessing.
- Provide new signatures for verifying reactor operations, in the case of nuclear safeguards.

Benefit to National Security Missions

Nuclear non-proliferation represents a major component of LANL's mission, and is aimed at reducing the threat posed by nuclear weapons proliferation or the illicit trafficking of nuclear materials through the long-term development of new and novel technology. The new diagnostic signatures for reactor operations proposed here directly address several components of this mission. This work is of potential interest to non-proliferation programs.

Progress

We have reanalyzed the plutonium and uranium isotopes from three of the samples, as well as the fission product data for ^{137}Cs , ^{85}Kr , ^{155}Eu , ^{154}Eu and ^{152}Eu . In addition, we have expanded our reactor burn code to include all of these isotopes, and to allow for shutdown of the reactor after 5 hours of running each day. Our analysis shows that the total mass of plutonium produced in any sample is only dependent on the total neutron fluence (neutron/area) that the sample was exposed to, and so we can use the mass spectroscopy results for the percentage weight of Pu in each sample to determine the neutron fluence it experienced. Once the fluence is determined, we can use the measured $^{240}\text{Pu}/^{239}\text{Pu}$ ratio to deduce the neutron flux (neutron/area/time). The flux varies across the reactor core, and some of the samples were declared to be outside the core, where the flux is lower than at any position in the core.

We found that the flux for the samples analyzed was not consistent with the declarations made by the nation who supplied Los Alamos with the samples through the IAEA. In addition, we deduced that the irradiation times were off by +/-10 hours (two days, when running for 5 hours/day). However, the deduced fluxes were consistent with other irradiation positions in the reactor, with longer irradiation times. Thus, it would appear that the

irradiation details for the samples were most likely simply recorded incorrectly.

Given a deduced flux, fluence, irradiation time and cooling time, all fission products production yields should be uniquely determined. For ^{137}Cs , we found that the calculations agreed with the values determined from gamma-ray spectroscopy measurements. For ^{155}Eu the calculations over estimated the measured yield by about 30%, which may be due to an overestimate of the cumulative fission field in the ENDFB/V-II database. For both ^{152}Eu and ^{154}Eu , the simulations fail to reproduce the measured yields. The production of both of these isotopes is quite complicated because neither is produced directly in fission. Instead they are produced by neutron capture on ^{151}Eu and ^{153}Eu , respectively, and their yield is only $\sim 10^{-5}$ micrograms. Thus, it is important that all paths leading to these isotopes be included. We are currently upgrading our reactor burn codes to address these needs.

For the experimental analysis of the other fission products of interest, such as Ru, Cs and the noble gases, we are developing new techniques to ensure that (1) in heating samples we retain these very volatile products within the measuring system, (2) we accurately account for isobaric interference, and (3) we account for isotopes that have decayed away (i.e., those with half-lives of 1 year or more), and track their daughters. The latter issues arises because the samples in question were discharged from the reactor almost 30 years ago. For the Ru and Cs isotope measurements, we plan to dissolve samples in HNO_3 , and to remove the actinides and barium using resins. The separated Ru and Cs isotopes of interest can then be assayed by gamma-ray spectroscopy. We are also developing fission product gas handling.

Future Work

The goal of the project is to measure the ratios of fission products, as well as the uranium and plutonium content, of a number of reactor-irradiated samples that were part of a plutonium production program. In FY14 we analyzed 3 of the available samples, and found that all ratios that depend on the total neutron fluence agreed well with experiment. However, for those observables that are dependent on both the fluence and flux there was poor agreement between experiment and theory. To address this problem in FY15 we plan to extend our reactor burn code to include neutron production and depletion of all isotopes of interest and their precursors.

On the experimental side of the project we propose to develop a gas handling system that will allow us to measure the Kr and Xe fission fragment products in several samples.

The system for this is designed to prevent (or at least minimize) noble gas losses. In addition, we plan to measure the daughters of the ruthenium isotopes, the rhodium and palladium isotopes. Analysis of the Rh and Pd isotopes will require correcting the measured yields in the samples for the direct fission yield of these, as well as their production via the beta decay of the Ru isotopes.

In FY15, we also plan to finalize and publish our analysis of the first three samples studied to date.

Conclusion

We will analyze 15 reactor-irradiated samples that are representative of a range of reactor fluxes, irradiation times, and shutdown times. The grade of plutonium will be determined for each sample and the relationship between the fluence and the Pu grade mapped out. We will expand on our theoretical methods for deducing reactor fluxes from the $^{136}/^{134}\text{Xe}$ and $^{135}/^{137}\text{Cs}$ ratios to include burn scenarios in which isotopic ratios have not necessarily reached equilibrium because of frequent reactor shutdowns. We will develop new techniques for extracting irradiation times from the xenon, krypton and ruthenium ratios, and derive the necessary inversion algorithms.

Publications

Hayes, A. C., and G. Jungman. Detection of Reprocessing of Weapons Grade Plutonium. To appear in *Plutonium Futures 2014*. (Las Vegas, 7-12 Sept. 2014).

Ultrafast Nanocomposite Scintillators: Decay Rate Enhancement by Electromagnetic Coupling to Plasmon Resonances

Richard C. Schirato
20140655ER

Introduction

Scintillators are materials which emit light when they absorb ionizing radiation, and enable a wide variety of radiation detection applications in basic science, medicine, and industry. How fast the light is emitted is dependent upon the material and the lifetime of its excited states. In certain applications, e.g. dynamic experimentation associated with Matter in Extremes, positron emission tomography (PET) neurological imaging, and X-ray Free Electron Laser (XFEL) diagnostics, researchers require light emission times on the order of or less than a nanosecond, one billionth of a second. Most bright scintillators with good absorption properties do not emit light this fast. The goal of this project is to produce scintillation materials with reduced emission lifetimes as compared to their unmodified form. This goal will be accomplished by fabricating nanocomposite structures which combine scintillation crystals with noble metal nanoparticles. The metal nanoparticles will couple electromagnetically to the excited states in the scintillator. If the plasmon (charge density quantized state) frequency of the nanoparticles equals that of the emitted light, then it is anticipated that the resulting resonant system will decay with a significantly higher light emission rate. Challenges in this work will include development of the nanocomposite scintillator fabrication process; tuning of the metal nanoparticles by shape, size, and material; and production of resultant macroscopic scintillators with good light transport properties. As a specific application goal, X-ray image conversion screens will be fabricated.

Benefit to National Security Missions

Matter in Extremes and stockpile stewardship dynamic experimentation imaging based upon X-ray Free Electron Laser or other accelerator fast pulse sources require faster scintillator light emission speeds than are achievable now. The goal of this project is to produce X-ray image conversion screens with significantly increased light emission rates. Other applications which may benefit

from increased scintillator decay rates include Positron Emission Tomography, positron annihilation diagnostics for defects in materials, basic nuclear and high energy physics science, accelerator diagnostics, and X-ray/Gamma imaging in Homeland Security.

Progress

Project Start-up

The project described here did not start on the fiscal year boundary, but was in response to a special call. The proposal was submitted in October 2013; and after a delay due to funding uncertainties, the project was started in March 2014. As of this date in June, the project has been proceeding for less than four months. Since the funding delay caused two postdoc researchers to be unavailable and some staff to reduce their commitments, staffing and planning are ongoing efforts. Despite delays, short project duration, and start-up issues, significant progress on multiple fronts has been made.

Proof of Principle Experiments

An experiment to demonstrate decay rate enhancement by coupling excited states to noble metal nanoparticle (NP) plasmon states has been designed. It involves measuring the fluorescence decay rate of molecules imbedded in an silica shell surrounding a silver NP as compared to the nominal rate. A “buy” versus make decision was made; and samples from a small business named nano-Composix were ordered. Delivery of said layered NP’s is expected soon. Measurement of decay rates at TA-35 are soon to follow.

A second set of experiments to measure the 1-d distance scale factors for short range quenching and longer range decay rate enhancement have been designed. The concept is based upon nanofabrication of silver disks with a range of diameters and pitches on sapphire wafers. Inert layers of varying thicknesses will separate the nano-disks from a fluorescent/scintillator layer. E-beam pattern and

nanofab techniques are being designed. Fabrication time at the Center for Nano Technology (CINT) has been secured with the first e-beam runs scheduled for next week.

Nanocomposite Scintillator Fabrication

Lutetium Aluminum Garnet activated with Cerium (LuAG:Ce⁺⁺) nanoparticles have been synthesized at TA-35. This rare earth oxide scintillator has been chosen as our first scintillator material test case. The LuAG:Ce⁺⁺ NP's were further encased in a thin silica shell. The silica cladding will allow for functionalization to permit nanocomposite fabrication without unwanted aggregation. In preparation for initial nanocomposite scintillator fabrication, a range of silver NP's were identified, then purchased and received from nanoComposix.

Plasmon/Photon Coupling Simulation

A Discrete Dipole Approximation software package was acquired, Additional software is being written to define dipole locations representing the scintillator and noble metal NP's configurations and shapes, and the surrounding matrix material. When complete, utilization of the simulation tools will inform scintillator NP design and will aid in experimental result analysis.

Imaging Instrumentation for Optical Characterization

The ultimate goal of the project is to develop technology applicable to fast X-ray image conversion screens appropriate for Matter In Extremes dynamic experiments. In order to characterize the screens for uniformity, X-ray efficiency, light output, spatial resolution, etc, an optical image measurement system is under development. A gated, intensified CCD camera has been acquired (borrowed) for that purpose, and is being integrated with a lab data acquisition computer. A Linear Systems Theory approach utilizing cascaded Modulation Transfer Functions has been adopted.

Future Work

Year One Tasks/Goals: (1) Work toward determining concept feasibility by production of small-scale nanocomposite scintillator samples with selected metallic nanoparticles. The goal is a measurable enhancement of decay rate as compared to the scintillator material without the noble metal nanoparticles. (2) Development of a semi-analytical computational tool to calculate the resonance properties of prolate, oblate, and spherical particles. Application of discrete dipole approximation simulation techniques to the calculation of resonance properties of non-spheroidal particles.

Conclusion

The goal is to fabricate nanocomposite scintillators en-

hanced with the addition of metallic nanoparticles which will emit light at a significantly increased rate. We expect to produce efficient X-ray image conversion screens with faster light emission rates than would be possible otherwise. These screens would enable X-ray imaging of Matter in Extremes dynamic experiments at faster frame rates than currently achievable. Other applications could include more efficient positron emission tomography scanners and improved accelerator diagnostics.

A Time Reversal Non Contact Acoustical Source for NEWS (Nonlinear Elastic Wave Spectroscopy)

Pierre-Yves Le Bas
20120116ER

Abstract

Nonlinear acoustic methods are the most sensitive in existence for application to nondestructive evaluation (NDE) of materials. These methods, broadly termed Nonlinear Elastic Wave Spectroscopy (NEWS), rely on acoustical wave distortion in the presence of cracks or other damage. One of the main obstacles to a broader use of NEWS in industry is the complexity of their implementation. To obtain a nonlinear signature, the amplitude of the signal generated in the object under test must be sufficiently large. To achieve such amplitude, a common technique is to glue transducers to the sample. This is not feasible for inline inspections. Common noncontact transducers are too weak for nonlinear measurements. In this project a novel acoustic source that can generate high amplitude waves without contact was developed. It is based on the principles of time reversal, a technique to focus wave energy in space and time.

The proof of concept prototype at the beginning of this project was promising yet required significant development. First, the strong coupling between the sample and the source required the source to be recalibrated at each step of a scan. Second, due to amplitude limitations, it was restricted to a stand of distance of a couple millimeters at most. Finally, the amplitude was not large enough for nonlinear measurements. Within the course of this project we optimized the coupling between the active elements and the air, which helped dramatically increase the standoff distance. This has resulted in a stand-off distance that can now be on the order of a few centimeters. The number of vibrating elements was also increased, which improved the maximum amplitude achievable. Finally a better enclosure that suppresses the coupling with the sample was designed, removing the need to continually recalibrate the source.

With our final prototype, we were able to detect a delamination in a composite plate. Potential future applications include detection of bad tracks in circuit boards be-

fore integration into satellites or study of the mechanical properties of mission related materials. Additionally this device can be used in any application that would benefit from, or currently utilizes air-coupled acoustic excitation.

Background and Research Objectives

Every day, critical mechanical parts are replaced according to lifetime estimates based on statistical measurements and safety margin calculations. A reliable means of detecting micro-fractures at the very beginning of formation would result in timely replacement of prematurely weakened components, thus avoiding catastrophic failure incidents. Reliable micro-fracture detection also offers the potential to mitigate catastrophic ignition events in rockets caused by the delamination between rocket fuel and outer casings, as well as detection of faulty satellite circuit boards that would likely not survive the launch.

Nonlinear Elastic Wave Spectroscopy (NEWS) has the potential to detect micro-fractures at their initiation, however, because current NEWS technology can be cumbersome to use, the economic benefits of these techniques has only been demonstrated to a limited extent. The technology developed in this project makes NEWS easier to implement and should help marketing those techniques to a wide range of industries. Indeed, NEWS techniques are based on quantifying the distortion of acoustic waves propagating into an object, especially the dependence of this distortion with the amplitude of the wave. To do this, one needs to generate high amplitude (though still nondestructive) waves in a solid. This is a challenge usually overcome in research labs by physically bonding transducers to the sample, often using epoxy, which renders the task of removing them quite difficult if not impossible without damaging the sample. Indeed, common non-contact sources are too weak or can only generate impulses which are not suitable to look at nonlinear components [1].

The objective of this project was to develop a system able to generate the high amplitude waves needed into a sample without contact. Before the start of this project, a proof-of-concept prototype [2] [3] that showed promise existed but it was too weak to be used with more than a couple millimeters standoff distance and had a strong dependence on the geometry of the sample to be excited. To be successful we had to overcome those limitations, thus creating a source that is powerful enough for non-contact nonlinear measurements.

Scientific Approach and Accomplishments

To create an acoustic source that fulfils our need, several aspects must be studied. First, it has to generate a vibration in air efficiently over the frequency range of interest. Second, this energy needs to be focused at a given point on the sample with a good signal to noise ratio. Finally, the source should be as independent of the sample as possible to limit the need for recalibration. We tackled most of those problems simultaneously during the project but for the sake of simplicity they are presented sequentially in the following sections.

Coupling to air

As stated above, nonlinear measurements require a large amplitude wave on the sample. To reach such amplitudes, one way is to increase the number of vibrating elements. The final design utilizes 32 elements. This final number is an optimization between transducer size and the size of the air cavity. The transmission of energy from the transducers into the air also needed to be optimized. Piezoelectric elements were used for their efficiency in the desired bandwidth (20 kHz– 100 kHz.), yet they do not transmit energy efficiently into air because of the large impedance contrast between the two media. This issue was addressed by bonding the piezoelectric elements to a plate with a specific profile that provides a smooth impedance-matching transition and thus maximizes the transfer of energy to the air. After numerical and experimental investigation, it was determined that a plate with a thickness decreasing as a cubic power law was the optimal design [4]. The design follows the idea of acoustic black holes used in some industrial applications to mitigate plate vibration, but exploits the previously unexplored acoustic radiation effect. In brief, as the elastic waves travel down a wedge with a power-law profile and approach the wedge tip the wave speed slows down. Practically, this means that a significant portion of the elastic energy is not reflected by the wedge tip and is trapped in the thinnest portion of the wedge, where the impedance match with air is the best.

Figure 1 depicts the acoustic radiation from a thin plate of constant thickness compared to that of a thick plate with a

power-law profile, when excited by a piezoelectric element (the white rectangle).

Improving signal quality

Once the vibration is transmitted into the air, it has to focus onto a specific point on the sample. One common way to accomplish this is to phase the signal of each emitter so that all the waves reach the specified point at the same time (phased array). This works if the geometries of the source and sample are known as well as their relative position. A more efficient strategy to achieve the focus of energy uses the principle of time reversal, which can be described briefly as follows. In a first step, referred to as the calibration, a wave is propagated from point A (source) to a point B on the sample. The second step is to time reverse (flip in time) the signal received in B and send it from the source point A. Due to the reciprocity principle and the invariance in time of the wave equation, this process creates an image of the signal first generated from A but at point B. If several transducers are used, i.e., several points A's and keeping the same point B, then when all the time reversed signals are sent simultaneously, they add up at the focal point B, thus creating at B an image of the source signal but at a much larger amplitude that can be achieved otherwise.

Although time reversal is a great technique to obtain large amplitudes using the above methodology, it also creates some artifacts, often called side lobes, in the signal generated at the focal point. For nonlinear applications, this is generally not important, as the only concern is that the frequency content remains the same (which is the case in this process). However, to broaden the field of application of this source, signal processing techniques were developed to improve the fidelity of the signal generated at the focal point with the original signal. The best technique developed so far is deconvolution [5] [1] [6] [2]. It is a signal processing operator that is applied to the signal before the time reversing step. The purpose of this operator is to account for the finite bandwidth of the transducer and propagating medium and also to generate additional signals that will cancel the side lobes. Figure 2 shows an example of the improvement in signal quality using deconvolution. This does come at a cost which is a reduction in amplitude of the signal at the focal point. Depending on application, the software written to control this new source has a built-in option to either use the standard time reversal process for maximum amplitude or to use deconvolution for maximum signal quality.

Decoupling from the sample

One of the other problems of the proof of concept prototype at the beginning of the project was the interactions between the sample and the source during the calibration

step, which resulted in a poor focalization of the signal if the sample was moved relative to the source after calibration [7] [3]. As a result, to scan an area for defect, the system had to be recalibrated at each point of the scan; a process that can be time consuming. To reduce the interaction between the source and the sample during the calibration phase, the geometry of the source was designed to be such that any wave reflecting from the sample to the source would be deflected away from the system. The enclosure of the source was constructed from 5mm thick aluminum to prevent sound from escaping at any other point than the designed opening [8].

Final design and results

Unifying all of the above considerations yield to the following design: 32 piezoelectric elements are placed on individual couplers (stainless steel plates of thickness varying according to a cubic power law). Those active elements are then placed in a non-symmetric distribution inside an enclosure made of 5mm thick aluminum. This enclosure has a parallelepiped shape at the bottom up to the height of the active elements and then funnels up to direct the wave out to the sample via an opening at the apex of the funnel. A tube penetrating through the bottom of the source up to the funnel opening allows a laser beam (used to detect vibration on the sample, if needed) to reach the sample surface without interacting with the wave field inside the source. An illustration of this final design and a photograph of the final prototype with one of the walls and the funnel removed are shown Figure 3.

The generation of the signal is done via arbitrary waveform generators controlled by an FPGA and routed through a set of amplifiers. All signals, either for calibration or actual measurements, are acquired via a laser Doppler vibrometer to facilitate both non-contact excitation and detection. A software element was also created to make the control and customization of this source easy and accessible to end-users. This software allows choosing the signal to be generated, whether to use basic time reversal or the deconvolution version, and also for nonlinear analysis of the signals on the sample.

To test the final prototype, experiments were conducted on a plate made of composite material (carbon fiber reinforced plastic, CFRP) with a delamination inside. This sample was well characterized in previous studies and was thus a perfect candidate for testing our final prototype. The CFRP sample was held above the source and moved horizontally in order to scan a particular region of interest. Figure 4 shows a picture of the setup with a standoff distance of 2 cm. The sample was measured using a scan grid of 60 by 40 mm every millimeter. At each point the nonlinear signal is measured and quantified. Two scans

were done. In the first one the source was recalibrated at each point while in the second scan the source was calibrated only once at an arbitrary location. For each case, the nonlinear signature was characterized at all scanning points. Figure 4 shows the map of the nonlinearity for both scans. As it can be seen, both look similar and both identify a zone of high nonlinearity where the delamination is located.

The results in Figure 4 demonstrate the success of the project, i.e., we created a noncontact source that can 1) generate vibration with enough energy that it can be used for nonlinear studies such as the detection of small cracks or delamination, 2) remove the need to recalibrate at each point of a scan making this inspection process up to 10 times faster, and 3) provide a completely non-contact solution that can be used in many applications.

Impact on National Missions

Although no follow-up project has been started yet because the demonstration of the final prototype is too recent, several program managers expressed interest in using the prototype developed within this project. Some examples include: touchless inspection of irradiated or radioactive materials; detection of delamination between fuel and casing on rockets or tanks and substrate on satellite circuit boards. In addition, this project recruited a research scientist doing experimental acoustics to LANL as well as a post-doc doing numerical simulations of experiments to help optimize the experimental device. Due to the great value of the work from this post-doc, we intend to try to convert him as a research scientist at the end of his contract. Both of those hires strengthen our team and bring new capabilities to LANL.

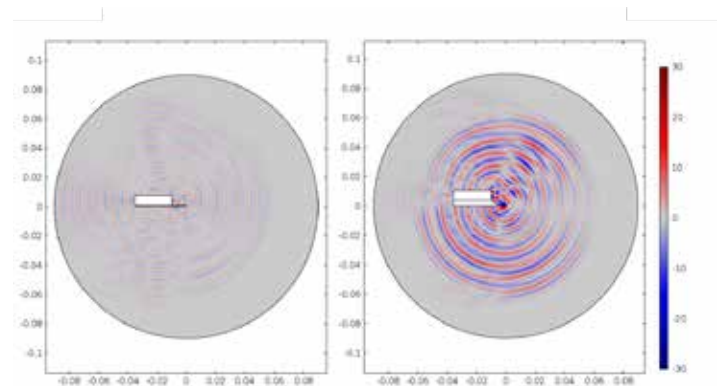

Figure 1. Improving the transmission of elastic energy to air using a plate of variable thickness. Left: acoustic pressure radiated by a piezoelectric element affixed to a plate with a constant thickness of 0.6 mm. Right: the piezoelectric element affixed to a plate with a cubic profile.

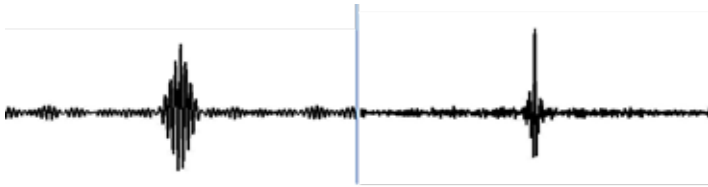

Figure 2. Improvement of the quality of the focused signal using deconvolution. Signal generated with standard time reversal on the left, using deconvolution on the right.



Figure 3. Final design illustration and photo

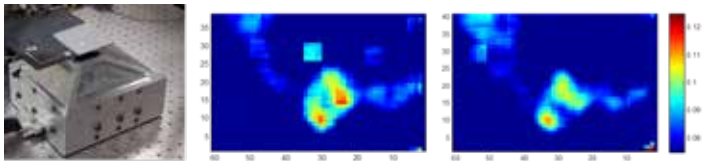

Figure 4. Detection of a delamination left, setup; middle, result with recalibration at each step of the scan; right, calibrating only once.

References

1. Remillieux, M. C., B. E. Anderson, T. J. Ulrich, P.-Y. D. Le Bas, M. R. Haberman, and J. Zhu. Review of air-coupled transduction for nondestructive testing and evaluation. 2014. *Acoustics Today*. 10 (3): 36.
2. Bas, P.-Y. D. Le, T. J. Ulrich, B. E. Anderson, and J. J. Esplin. A high amplitude, time reversal acoustic non-contact excitation (trance). 2013. *The Journal of the Acoustical Society of America*. 134 (1): EL52.
3. Bas, P.-Y. D. Le, T. J. Ulrich, B. E. Anderson, and J. J. Esplin. Toward a high power non-contact acoustic source using time reversal. 2012. *Echoes*, newsletter of the Acoustical Society of America. 22 (3): 7.
4. Remillieux, M. C., B. E. Anderson, P.-Y. D. Le Bas, and T. J. Ulrich. Improving the air coupling of bulk piezoelectric transducers with wedges of power-law profiles: a numerical study. 2014. *Ultrasonics*. 54 (5): 1409.
5. Anderson, B. E., J. Douma, T. J. Ulrich, and R. Snieder. Optimization of time reversal focusing and source reconstruction through deconvolution. To appear in *Wave Motion*.
6. Anderson, B. E., T. J. Ulrich, and P.-Y. D. Le Bas. Comparison and visualization of the focusing wave fields of various time reversal techniques in elastic media. 2013. *The Journal of the Acoustical Society of America*. 134 (6): EL527.
7. Delrue, S., K. A. Van Den Abeele, P.-Y. D. Le Bas, T. J. Ulrich, and B. E. Anderson. Simulations of a high amplitude air coupled source based on time reversal. 2013. In *International Congress on Ultrasonics*. (Singapore, 2-5 May 2013). , p. 591. Singapore: Research Publishing.
8. Remillieux, M. C., B. E. Anderson, P.-Y. D. Le Bas, and T. J. Ulrich. A high amplitude time reversal acoustic non-contact excitation (TRANSE): From a proof of concept to the understanding of the mechanisms involved. *Journal of Mechanical Systems and Signal Processing*.

Publications

- Anderson, B. E., J. Douma, T. J. Ulrich, and R. Snieder. Optimization of time reversal focusing and source reconstruction through deconvolution. To appear in *Wave Motion*.
- Anderson, B. E., T. J. Ulrich, and P. -Y. Le Bas. Improving the focal quality of the time reversal acoustic noncontact source using a deconvolution operation . 2013. In *International Conference on Acoustics*. (Montreal, Canada, 2-7 June 2013). Vol. 19, POMA Edition, p. 030080. Montreal: Acoustical Society if America.
- Anderson, B. E., T. J. Ulrich, and P. -Y. Le Bas. Comparison and visualization of the focusing wave fields of various time reversal techniques in elastic media. 2013. *Journal of the Acoustical Society of America*. 134 (6): EL.
- Bas, P. Y. Le, T. J. Ulrich, B. E. Anderson, and J. J. Esplin. Toward a high power non-contact acoustic source using time reversal. 2012. In *163rd Meeting of the Acoustical Society of America*. (Hong-Kong, Hong-Kong, 13-18 May, 2012). Vol. 131, p. 3461. N.A: Journal of the Acoustical Society of America.
- Bas, P. Y. Le, T. J. Ulrich, B. E. Anderson, and J. J. Esplin. Toward a high power non-contact acoustic source using time reversal. 2012. *Echoes*, Newsletter of the Acoustical Society of America.
- Bas, P. Y. Le, T. J. Ulrich, B. E. Anderson, and J. J. Esplin. A high amplitude, time reversal acoustic non-contact excitation (trance). 2013. *JOURNAL OF THE ACOUSTICAL SOCIETY OF AMERICA*. 134 (1): EL52.
- Delrue, S., K. A. Van Den Abeele, P.-Y. D. Le Bas, T. J. Ulrich, and B. E. Anderson. Simulations of a high amplitude air coupled source based on time reversal. 2013. In *International Congress on Ultrasonics*. (Singapore, 2-5 May

2013). , p. 591. Singapore: Research Publishing.

Remillieux, M. C., B. E. Anderson, P.-Y. D. Le Bas, and T. J. Ulrich. A high amplitude time reversal acoustic non-contact excitation (TRANCE): from a proof of concept to the understanding of the mechanisms involved,. *Journal of Mechanical Systems and Signal Processing*.

Remillieux, M. C., B. E. Anderson, P.-Y. D. Le Bas, and T. J. Ulrich. Improving the air coupling of bulk piezoelectric transducers with wedges of power-law profiles: a numerical study. 2014. *Ultrasonics*. 54 (5): 1409.

Remillieux, M. C., B. E. Anderson, T. J. Ulrich, P.-Y. D. Le Bas, M. R. Haberman, and J. Zhu. Review of air-coupled transduction for nondestructive testing and evaluation. 2014. *Acoustics Today* . 10 (3): 36.

Ulrich, T. J., B. E. Anderson, P. Y. Le Bas, C. Payan, J. Douma, and R. Snieder. Improving time reversal focusing through deconvolution: 20 questions. 2012. In *International Conference on Nonlinear Elasticity in Material*. (Cefalu, Italy, 1-8 July, 2012). Vol. 16, POMA Edition, p. 045015. Cefalu, Sicily, italy: Acoustical Society of America.

Nuclear Quadrupole Resonance: From no Field to Ultra-Low Field

Michelle A. Espy
20120218ER

Abstract

Nuclear Quadrupole Resonance (NQR) is an electromagnetic technique for detection of nuclear species with spin ≥ 1 (most commonly the abundant isotope of nitrogen, ^{14}N). Such nuclei have a nuclear quadrupole moment that can couple with the electric field gradient of the surrounding electron cloud to produce energy level splitting. Unlike nuclear magnetic resonance (NMR), an external magnetic field and associated complexity are not required to produce this splitting. However such an external field can be used to enhance the NQR signal. As with NMR, application of electromagnetic radiation at the frequency of the splitting can produce measurable re-emission that sensitively reflects the chemical structure. Many materials including solid explosives (TNT, RDX, HMX, PETN) and drugs or chemicals (heroin, cocaine, melamine) have measurable concentrations of ^{14}N . Thus NQR can be a powerful tool for non-invasive detection of these items. NQR has been used in luggage screening and landmine detection, and is currently being investigated as a method to screen for concealed drugs and/or counterfeit pharmaceuticals. LANL has a world-leading capability in ultra-low field (ULF) NMR and imaging (MRI) with readout at 10-100 μT magnetic fields ($\sim\text{kHz}$ frequencies). This has been applied to a variety of applications including functional and anatomical imaging of the human brain, nuclear non-proliferation, and homeland security (screening of liquid explosives). However, the ability to detect solids by these methods is limited by the short signal decay times. Detection of liquid explosives by ULF NMR could be complimented by the ability to detect solid explosives by NQR. Under our LDRD project we accomplished our goals of demonstrating polarization enhanced NQR to increase signal and/or speed-up acquisition and NQR combined with NMR. This work has led directly to follow-on funding from DARPA for the use of NQR combined with NMR imaging to detect improvised explosive devices. More importantly, LANL now possesses NQR in its arsenal of tools for detecting and characterizing nitrogen containing materials.

Background and Research Objectives

Nuclear Quadrupole Resonance (NQR) is a sensitive probe of the chemical structure of quadrupolar nuclei. Nuclei with spin $> 1/2$ have an electric quadrupole moment, i.e. a non-spherical charge distribution, which couples to lattice electric field gradients to produce energy level splitting characteristic to particular chemical compounds. These splittings manifest as chemical-specific spin oscillation frequencies following an applied rf pulse [1,2]. NQR of ^{14}N , in particular, allows non-invasive identification of most common explosives (TNT, ammonium nitrate) and narcotics (heroin, cocaine) with high accuracy [3]. Unlike NMR, an external static magnetic field is not required. For that reason it is also referred to as “zero-field” NMR. Due to relatively low frequencies (< 10 MHz) of the signal, however, traditional NQR detectors based on high-Q, tuned pickup coils have very low SNR and a limited detection bandwidth. For that reason, methods involving pre-polarization with a magnetic field to enhance the NQR signal are often of interest.

We at LANL have perfected methods of ULF NMR relaxationometry and magnetic resonance imaging (MRI) for a variety of applications from detection of liquid explosives [5, 6] to medical imaging (see for example [7]). In these approaches, a pre-polarization field on the order of 10 – 100 mT produces magnetization and the NMR signal is then read-out in a much lower magnetic field 10 – 100 μT . While the SNR is reduced in this approach compared to NMR at high magnetic fields (magnetization scales linearly with B), the approach has several advantages. The low magnetic fields are suitable for fielded applications (no big magnets or fields). The fields do not have to be highly homogeneous. The low frequency readout enables detection through metal not possible in conventional NMR. Moreover, the system has variable magnetic fields that can exploit the changes in T1 contrast as a function of magnetic field. T1 is the time for nuclear splitting (or sample polarization) to establish. In this ULF regime (with signal frequencies $< 100\text{kHz}$), T1 contrast

is greater between certain materials. While early systems used highly sensitive SQUID magnetometers, recently, we have advanced the sensitivity of detection of low frequency magnetic signals for NMR using inductive coils [8].

Because the method has dead time between removal of the pre-polarization field and measurement, materials with very short decay times ($T_2 < 1$ ms), such as solids, are quite hard to measure. Thus, while ULF NMR has proven very powerful for liquids, the ability to detect solids by these methods is limited. Often it would be complimented by detection of ^{14}N (for example the Christmas 2010 bomber used both a small amount of liquid, and PETN, a nitrogen containing solid). Similarly, NQR doesn't work on liquids, so the methods complement. In anatomical imaging, ^{14}N is significant in protein and NQR can reveal the health of muscle in combination with anatomical images via the NMR image [9]. Moreover, NQR has shown significant promise for stand-off detection of hidden bombs (especially landmines) or even contraband on or in the body. It is important to note that NQR is not a trace method. Combining NQR with ULF NMR/MRI would be a very powerful addition to LANL's capability and develop multiple avenues of applications from better medical diagnostics, to global security, to fundamental materials studies.

Low signal-to-noise is the primary limitation to NQR. When the NQR spectral lines are at low frequencies (< 1 MHz, e.g. TNT), signals are usually very weak and not easy to detect [10]. Significant research has been applied to methods to increase the NQR signal. It has been shown that the NQR signal can be enhanced by two different mechanisms both using a pre-polarization field and polarization transfer between the protons and nitrogen at the proton-nitrogen level crossing [11]. Thus, not only would NMR and NQR be complementary, but our particular method of pre-polarized NMR/MRI is ideally compatible with the approach of polarization enhanced NQR. Based on this, we established the following goals for the project.

NMR cross-relaxation: In this approach marked changes in the proton T_1 are observed at proton Larmor frequencies corresponding to the NQR signal frequency. When the frequencies are matched the proton can transfer energy to the ^{14}N (or vice versa). This approach requires scanning the magnetic field (Larmor frequency) and measuring T_1 at multiple points to map out these changes, which manifest as peaks or dips in the signal. The change in T_1 is an indirect indication of ^{14}N , and the location of the dips provides the chemical information. This approach has been used for detection of TNT. We and others have observed the effect in tissues with high protein concentrations, due to couplings between the protons and quadrupolar ^{14}N in protein molecules' backbones. This approach is advan-

tageous in that the proton population is typically much larger than ^{14}N and can enable read-out at any frequency (not just the NQR frequency). However, conventional MRI typically utilizes a very high magnetic field (to further increase proton signal) which requires the magnetic field to be highly homogeneous. This can make practical or bulk sample application very difficult.

Direct NQR detection with polarization enhancement: In this method pre-polarization is followed by adiabatic reduction of the magnetic field so that it crosses through the proton-nitrogen level crossing. The initial polarization time must be long enough to allow complete proton polarization (~ 3 or more times longer than the proton T_1 time). The proton T_1 of materials can depend strongly on temperature and the polarization field strength. As the magnetic field is ramped to zero through the proton-nitrogen level crossing, the protons can transfer their energy to the ^{14}N . The efficiency of cross-polarization transfer depends on the strength of the proton-nitrogen coupling ν_{NH} . For TNT this is ~ 500 Hz (or 2 ms). Successful polarization transfer requires the cross-polarization be long compared to $1/\nu_{\text{NH}}$. This establishes the field ramp-down condition $dB/dt \ll \Delta\nu_{\text{H}}/\nu_{\text{NH}}$ where is the $\Delta\nu_{\text{H}}$ proton NMR line width. In Luznik [10] this was ~ 20 kHz (0.5 mT) which lead to a limit of 250 mT/s, easily obtained by our present hardware. Once the polarization transfer is complete, the NQR is performed by traditional methods. Enhancements of up to 10X have been observed at 250 mT. This approach has also been shown to be successful for low SNR materials such as TNT.

Scientific Approach and Accomplishments

Our first task was to develop a small bench-top NQR system in which to develop the basic capability without polarization enhancement. This system is shown in Figure 1 and was described in detail in our publication [12]. Using this system we demonstrated NQR detection of NaNO_2 (NQR frequency of 4.6 MHz) to evaluate system signal-to-noise and temperature stability. We were able to detect the signal from NaNO_2 as well as measure the T_1 (polarization) time of the material with excellent agreement to values reported in the literature [13, 14]. These results are shown in Figure 2.

We then developed a system for polarization enhancement by transfer of the signal from ^1H (proton) to ^{14}N . We chose the sample ammonium nitrate (AN) because it has a relatively low NQR frequency (~ 400 kHz) making it very difficult to detect, because it is an explosive commonly used in improvised explosive devices (i.e. interesting for national security), and because it contains two spin sub-systems, ^1H to ^{14}N , making polarization enhancement

possible.. A schematic and photograph of the polarization enhancement system is shown in Figure 3. In this system a sample is mechanically moved from the region of the magnet, which can achieve ~ 280 mT, to the region of NQR interrogation. In the magnet 1H is spin polarized as occurs in the process of NMR. However, as the sample leaves the magnet, the magnetic field decreases to the transition point where the 1H frequency and 14N frequency overlap, resulting in polarization being transferred to the 14N . Inside the NQR chamber, regular 14N NQR is then performed, but the signal is larger due to the extra polarization of 14N .

We demonstrated a dramatic increase in the SNR of the NQR signal by using polarization enhancement. The largest enhancement factor we observed at 280 mT was 12.5 ± 0.6 . Without polarization enhancement the signal from AN was only able to be recorded after significant averaging for a time of 1.5 hours. With polarization enhancement, a comparable SNR for the NQR signal was measured in 40 sec. These data are summarized in Figure 4.

The accomplishments described above completed goal #2 for direct NQR detection described above. These were very significant accomplishments as this capability in polarization enhanced NQR provided the preliminary data that was vital to our achieving funding from DARPA MEDS for an NQR-based project on detection of explosives inside high water content opaque media, as we will describe later.

To demonstrate NMR-based readout of the NQR signals (known as cross-relaxation) we used a field cycling NMR relaxometer to study various isotopes of nitrogen in AN. In this method we perform a study of the NMR signal amplitude as a function of magnetic field. The chemical formula for AN is $(\text{NH}_4)(\text{NO}_3)$. We then proceeded to repeat the measurement for two formulations of AN where various nitrogen groups were replaced with the non-NQR active isotope 15N . These data illustrate the various contributions of different groups to the NQR spectra, as well as the spectroscopic power of the NQR method to study chemical structure. The fact that some contributions appear as peaks and others dips indicates that in the former case the relaxation time of hydrogen is short relative to nitrogen and in the latter case the relaxation time of hydrogen is long relative to that of nitrogen. These effects, to our knowledge, have not been reported elsewhere and a manuscript is currently in preparation. This ability to study chemical structure could have significant implications for various materials being studied at LANL, and completed our goal #1 for the project.



Figure 1. A photograph of our NQR system developed for this LDRD project.

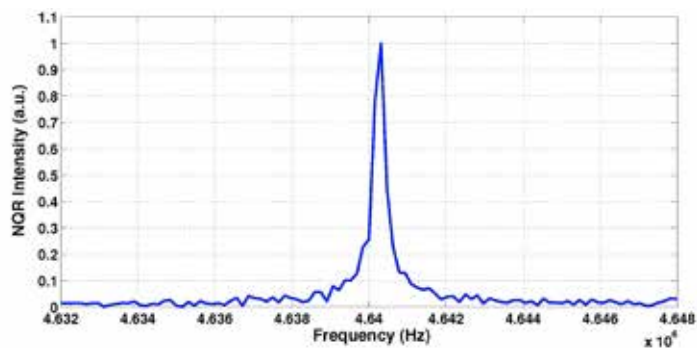

Figure 2. The NQR spectrum from 40g of NaNO powder after 50 data averages. A clear NQR peak was detected at 4.6403 MHz.

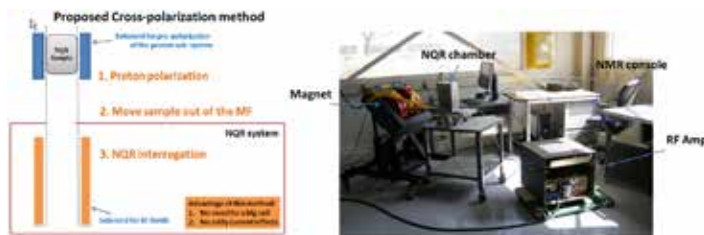

Figure 3. Schematic (left) and photograph (right) of our polarization enhanced NQR system.

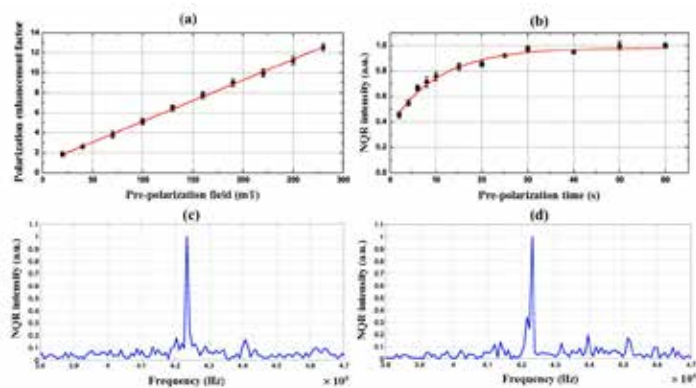

Figure 4. Summary of polarization enhanced data from AN. (a) Measurement of polarization enhancement factor vs. pre-polarization field strength. The solid curve indicating a linear fit ($y=ax+b$, where $a=(1.00 \pm 0.05)$, and $b=(4.13 \pm 0.03) \cdot 10^6$) (b) Signal

intensity vs. pre-polarization time. The solid curve indicating an exponential fit ($y=ae^{-y}$, where $a=(-0.61\pm 0.03)$, $y=(0.98\pm 0.01)$, and $t=(11\pm 2)$) (c) NQR signal from 50 g of AN powder at 423.5 kHz with polarization enhancement. Total acquisition time including polarization ~ 40 s, with the SNR being ~ 23 . (d) NQR signal at 423.2 kHz without polarization enhancement. 100 averages were required. Total acquisition time 1.5 hours. SNR ~ 27 .

Impact on National Missions

NQR is an important diagnostic method for the study of materials, which can be as powerful as NMR in certain circumstances. Prior to this LDRD project, there was no capability for NQR at LANL, despite its importance to the study and detection of explosive materials. Continuing to advance our capabilities in the area of advancing the safety and effectiveness of explosive materials on the one hand, and detecting them on the other, is a vital area of the laboratory, both for the weapons and global security missions.

With project we developed a unique capability in NQR as well as extended the method via polarization enhancement methods to address the issues of low signal-to-noise and/or long measurement times that have historically limited field applications of NQR. Data obtained through this project we enabled a new project from DARPA to use polarization enhanced NQR combined with ultra-low field MRI for the stand-off detection of explosives concealed in high water content opaque media. This project is poised to make a field demonstration of explosives detection at the Transportation Security Laboratory early in 2015.

This NQR capability also helped us attract and support several excellent post-doctoral researchers over its duration.

We anticipate continued opportunities to integrate this NQR capability into various aspects of the laboratory from basic characterization and scientific understanding of materials, using NQR to study the properties and provenance of materials for global security, and using stand-off NQR for the detection of explosives for sponsors like DARPA, DHS, and JIEDDO.

References

1. Smith, J. A. S.. Nuclear quadrupole resonance spectroscopy, general principles. 1971. *Journal of Chemical Education* . 48: 39.
2. Lee, Y. K.. Spin-1 nuclear quadrupole resonance theory with comparisons to nuclear magnetic resonance. 2002. *Concepts in Magnetic Resonance*. 4: 155.
3. Osan, T. M.. Nuclear Quadrupole Resonance: From imaging to explosives and drug detection. 2007. *Physica B*. 389: 45.
4. Garroway, A. N.. Nuclear Quadrupole Resonance. 2003.

Alternatives for Landmine Detection.

5. A, M.. Ultra-low-field MRI for the detection of liquid explosives. 2010. *Superconductor Science and Technology*. 23 (3): 034023.
6. Espy, M. A.. Progress on detection of liquid explosives using ultra-low field MRI. 2011. *IEEE Transactions on Applied Superconductivity*. 21 (3): 530.
7. Jr., R. H. Kraus, M. A. Espy, P. E. Magnelind, and P. L. Volegov. Ultra-low field Nuclear Magnetic Resonance a new MRI regime. 2014.
8. Matlashov, A. N.. SQUIDs vs. induction coils for ultra-low field nuclear magnetic resonance: experimental and simulation comparison. 2011. *IEEE Transactions on Applied Superconductivity*. 21 (3): 465.
9. Ungersma, S. E.. Magnetic Resonance with T1 dispersion contrast. 2006. *Magnetic Resonance in Medicine*. 55 (6): 1362.
10. Luznik, J.. Improved NQR detection of trinitrotoluene using polarization transfer from protons to ^{14}N nuclei. 2007. *Journal of Applied Physics*. 102: 084903.
11. Luznik, J.. Polarization enhanced NQR detection at low frequencies. 2009. In *Explosives detection using magnetic and nuclear quadrupole resonance techniques*, NATO Science for Peace and Security, Series B. , p. 41. Amsterdam: Springer.
12. Kim, Y. J., T. Karaulanov, M. Espy, A. Matlashov, S. Newman, A. Urbaitis, P. Volegov, and J. Yoder. Nuclear Quadrupole Resonance Technique for Solid Explosive Detection . 2014. *Solid State Nuclear Magnetic Resonance*. 61-62: 35.
13. Garroway, A. N., M. L. Buess, J. P. Yesinowski, and J. B. Miller. Narcotics and explosives detection by ^{14}N pure nuclear quadrupole resonance . 1993. *SPIE Substance Detection Systems*. 2092: 318–327..
14. Peterson, G., and P. J. Bray. ^{14}N nuclear quadrupole resonance and relaxation measurements of sodium nitrite . 1976. *Journal of Chemical Physics*. 64: 522.

Publications

Kim, Y., T. Karaulanov, J. Yoder, A. Matlashov, S. Newman, A. Urbaitis, P. Volegov, and M. Espy. Development of a Pulsed ^{14}N Quadrupole Resonance Technique for Solid Explosives Detection. Presented at Experimental Nuclear Physics Conference. (Asilomar, CA, April 14-19, 2013).

Kim, Y., T. Karaulanov, M. Espy, A. Matlashov, S. Newman, A. Urbaitis, P. Volegov, and J. Yoder. Nuclear Quadrupole Resonance Technique for Solid Explosive Detection. 2014. *Solid State Nuclear Magnetic Resonance*. 61-62: 35.

Time-gated Super Resolution Imaging

James H. Werner
20120227ER

Abstract

Recently, there have been revolutionary developments in fluorescence microscopy that enable optical imaging at approximately 10 nanometers resolution.[1-2] This is over an order of magnitude better than the diffraction limit of light (a few hundred nanometers for visible wavelengths). This increased resolution has substantially enhanced our mechanistic understanding of cellular structure and function. While these super-resolution methods were originally used to image 2D slices of cellular structure, they were more recently extended to 3D visualization with a limited Z-range (approximately +/- 500 nm).[3-4] Unfortunately, this Z imaging range is inadequate to explore deep tissue samples, view entire mammalian cells, or to be of much use in soft-materials characterization. This project aimed to extend the Z-range of these super-resolution methods by over an order of magnitude: from ~600 nanometers to tens of microns. This dramatic increase in Z-range enables the visualization of protein structure throughout the entire volume of a biological cell and will enable 3D visualization of selected and functionally important nano-structured polymers. This work developed new methods for fast 3D fluorescence imaging of cells and select soft materials. This system also can be employed for deep photo-activation of molecules for super-resolution imaging.

Background and Research Objectives

In 2006, Betzig et al.[1] reported a method for fluorescence microscopy that exceeds the diffraction limit of light. This method is based upon photo-switchable fluorophores and single molecule localization. These new super resolution imaging methods are based upon the fact one can determine the central position of a single fluorophore to a much greater precision than the width of the diffraction limited image.[5] This is illustrated in Figure 1 (adapted from a review from our laboratory[6]), which shows a pedagogical example of super resolution imaging of a 1 micron wide nano plus sign. Figure

1a shows the structure of the nano plus sign, whereas Figure 1b shows its corresponding diffraction-limited wide-field fluorescence image as it would appear if all fluorescent dyes were in a bright, emissive state. After switching all dye molecules to the “off” state (Figure 1c), a single stochastically selected dye molecule is switched back to the emissive “on” state. The spot is imaged (Figure 1d) until it either switches back to a dark state or irreversibly photobleaches. The centroid of the diffraction-limited spot is localized with high precision by fitting with a two-dimensional Gaussian representation of the microscope’s point spread function. The resulting centroid coordinates are plotted as a single point on a super-resolution image template (Figure 1e). The process of stochastically turning on, imaging, and localizing one molecule at a time is repeated many times until the evolving superresolution image contains enough stipple points to reconstruct the target image as depicted in Figure 1f.

While super resolution methods originally were limited to 2D slices, they have been extended to three dimensions with a limited depth of field (~ +/- 500 nm)[3-4]. Our primary research goal is to extend the Z-depth of these super-resolution over an orders of magnitude, such that we can obtain important nanoscale information over tens of cubic microns, a volume relevant to the function and structure of biological cells and nano-structured polymers or select soft materials. Our research goals are:

Goal 1. Develop the instrumentation necessary for imaging at ~ 10 nm resolution over ten cubic microns.

Goal 2. Benchmark this instrument by studying the 3D nanostructure of selected soft materials. In particular, many plastics add small concentration of nanoparticles to the blend for enhanced polymer stability. We proposed to use the advances in instrumentation achieved in goal 1 to visualize polymer/nanoparticle blends and interactions.

Goal 3. Demonstrate 3D nanoscale imaging of the actin cytoskeletal network of a whole cell. In particular, mammalian cells are not just “bags” of protein, DNA, and RNA, but rather have a rigid (and re-configurable) network of polymers (the actin cytoskeleton) that provide an important scaffold and transportation infrastructure. We proposed to image this important polymer framework throughout the full 3D volume of a cell, rather than just over a single 600 nanometer slice as was performed previously in super resolution microscopy[3].

Scientific Approach and Accomplishments

While super resolution imaging by single molecule localization microscopy has been previously extended to 3D imaging, the depth of imaging was limited to +/-500 nm above and below the image plane.[3-4] This is due to the fact that these super-resolution imaging techniques rely on single molecule detection and localization, with the localization accuracy of a single molecule degrading rapidly with increasing background.[5] Obviously, in large enough backgrounds, single molecule detection itself becomes impossible. A method to reduce the background in thick cell or tissue samples is essential for 3D super resolution imaging.

We note there are several sources of background in super-resolution fluorescence microscopy. In particular, the background from Raman scattered laser light, fluorescent impurities, or fluorescence from un-activated molecules in the field of view are a very important, often dominant, noise source in super resolution imaging. These sources of background are the primary reason super-resolution imaging methods have so far been limited to samples less than 1 micron in depth, because use of thin samples limits background generation from the bulk material.

In this project, we endeavored to develop a method to only activate a thin layer in the sample for super-resolution imaging, such that the layers above and below the imaging plane were not contributing any fluorescence background. Our original efforts focused on two photon activation of the molecules of interest[7], with time-gating used to further suppress Raman or Rayleigh scattered light. Two-photon activation requires the simultaneous absorption of two photons of near infra-red light from a mode-locked excitation laser. Due to the nonlinear nature of the excitation process, one can selectively activate molecules within a z-slice of approximately a micron in height. However, while this approach is promising, two photon activation is a “point” activation process that requires raster scanning of the excitation beam to selectively activate a single plane. This slow activation process would need to be followed by several imaging cycles (which also would be

done on a point by point basis). While this approach clearly is feasible, the time required for imaging cycles (several hours) was not optimal. As such, we moved away from two photon activation of the molecules towards molecular activation using selective plane illumination.[8]

Unlike epi-excitation, which excites regions well above and well below the current image plane, selective plane illumination[8] only excites a thin slice of the sample (Figure 2). The fluorescence from this thin sheet is then imaged with a separate objective onto a CCD camera. The primary advantage of selective plane illumination microscopy is that only the imaged slice undergoes fluorescence excitation, thus dramatically limiting background and photodamage. Moreover, accurate depth encoding is an immediate benefit, as the width of the excitation sheet inherently leads to Z sectioning. Due to the fact a whole slice of the sample is imaged at once, this method is orders of magnitude faster than laser scanning confocal microscopy, with the current state of art being 200 Z-slices per second[9]. The increased throughput of the light sheet methods (in addition to its inherent 3D section capabilities) was the reason we adopted this new method early in this research project for super resolution imaging applications.

The simplest method for light sheet excitation is to use a cylindrical lens to focus a standard Gaussian-shaped laser beam into a thin sheet of light[8]. However, for smaller beam waists (less than a micron), the diameter of a focused Gaussian beam diverges rapidly (roughly doubling in size only a micron away from the beam focus). To employ light-sheet methods for smaller beam waists (e.g. smaller imaging slices needed for cellular microscopy), several groups (most notably Planchon et al)[9] have turned to rapid scanning of a Bessel beam for selective plane illumination. Unlike a Gaussian laser focus (which diverges rapidly due to diffraction), Bessel beams can be collimated at very narrow beam waists (0.3 microns) for nearly 100 microns[9].

However, a problem with using a swept Bessel beam for fluorescence excitation or single molecule activation is that the side-lobes of the Bessel beam can create out of focus fluorescence. This fluorescence background can be minimized by using two photon excitation (which requires expensive mode-locked excitation laser sources operating in the near infrared).[9] Other research labs have used cheap visible lasers for Bessel beam selective plane illumination microscopy, minimizing the contribution of the side lobes to the image by spatially filtering this fluorescence with a physical slit. However, previous applications using a physical slit for spatial filtering required synchronization between multiple galvo-mirrors or synchronization of a galvo mirror with the rolling shutter of a CMOS camera as well as a time-consuming calibration procedure. In this project,

our lab developed an optical microscope design capable of spatially filtering out the side lobes of the Bessel beam using only a single galvo mirror, which has no synchronization or calibration issues. This microscope is described in greater detail in “Fast, 3D imaging via confocal line scanning of a Bessel beam using a single galvo mirror” Proc. of the SPIE 8947, 1-8, (2014)[10] with its design shown schematically in Figure 3. This paper benchmarked this system by visualizing polymer nano-beads embedded in the polymer polydimethyl siloxane (PDMS), in support of Research Goal 2 of the project. The power of this method for imaging cell samples was further described in, “Confocal line scanning of a Bessel beam for fast 3D Imaging,” Zhang, P, Phipps, M, Goodwin, P and Werner, J, Optics Letters 39, 3682-3685, (2014) [11], with an image of a cell taken from this paper shown in Figure 4. This work led to a Los Alamos invention disclosure, “Method and Apparatus for Fast 3D Imaging,” Zhang, P, Goodwin, P and Werner, J, LANL Invention Disclosure S-133062 (2013), which we anticipate will result in a US Patent application.

While this project primarily focused on pushing the Z imaging depth of super resolution imaging microscopy, in our research into methods to create Bessel beams for selective activation of a single layer in a sample, we realized that one could also use scanned Bessel beams to increase the imaging speed of another super resolution optical microscopy method, stimulated emission depletion microscopy (STED)[12]. In particular, in our efforts to understand how phase plates can be used to convert Gaussian beams to Bessel beams, we realized that through a modification to the annular phase ring used to create a zeroth order Bessel beam (which most people are using for excitation in selective plane microscopy), one could create a first order (J1) beam. Our laboratory then realized that this J1 beam (which has a node or zero in the central position) could be combined with a J0 beam to perform stimulated emission depletion (STED) microscopy in a line-scan, rather than a point scan, modality. This is a tremendous proposed advance for STED microscopy, increasing imaging speeds by a factor of 400 or greater. Our paper describing this advance, “Fast, super resolution imaging via Bessel-beam stimulated emission depletion microscopy,” by P Zhang, P, Goodwin, and J Werner, was published in Optics Express 22, 12398-12409, (2014), Reference [13]. Figure 5 is a brief summary of some of the findings of this paper, showing calculated J0 and J1 beam profiles and the resolution enhancement that can be obtained as a function of STED laser power. Of note that Reference [13] was among top 10 most downloaded articles for Optics Express in May 2014, despite only being published halfway through the month (May 14th). We have also submitted an invention disclosure describing this microscope design (LANL invention disclosure S133157/

L2014019S-101, “Fast, Supra-Video frame Rate Super Resolution Imaging via Bessel-Beam Stimulated Emission Depletion Microscopy”).

In addition to developing a method for rapid 3D imaging and rapid photo-activation of molecules deep in biological tissues or soft materials for super resolution imaging, we also developed a new method for 3D molecular localization. In particular, one aspect of Reference [13] was the use of interference to suppress the fluorescence emission from the side-lobes of the Bessel beam in the axial direction of the microscope. From this investigation and thoughts about interference in the axial direction of microscopes in general, we developed an idea for localizing single molecules in 3 dimensions using interference of the single molecule emission. While interference methods have been demonstrated before for 3D single molecule localization previously[4], these methods required two high numerical aperture microscope objectives in close juxtaposition (which increases instrument complexity and the types of samples that can be studied). The methods introduced in Reference [4] also has interfering fluorescence traverse different beam paths, making the method susceptible to drift. Our proposed design uses a single high numerical microscope objective (enabling imaging of a wider array of samples) and has the interfering beams traverse essentially the same beam path, which should be less sensitive to drift.[14] This 3D molecular localization scheme is further described in, “Interferometric 3D single molecule localization microscopy using a single high numerical-aperture objective” which is under its second round of review at Applied Optics.[14]

Impact on National Missions

This project supported a number of important Laboratory and National Missions in biosecurity science and soft materials research. Use of this new instrumentation may lead to a better understanding of host-pathogen interactions and the effects of nanoparticles and biological or chemical toxins on cells. In addition to greatly impacting LANL efforts in biosecurity science, this work also enables structural determination for important functional nano-structured materials and polymers that can serve as scaffolds for light-harvesting and photovoltaic applications. Future work on cellular imaging may be supported through the National Institutes of Health (NIH) or the Defense Threat Reduction Agency (DTRA). Three dimensional characterization of soft, functional nanomaterials can gain support through the Department of Energy, Basic Energy Sciences. We are currently working on an NIH proposal to continue this work.

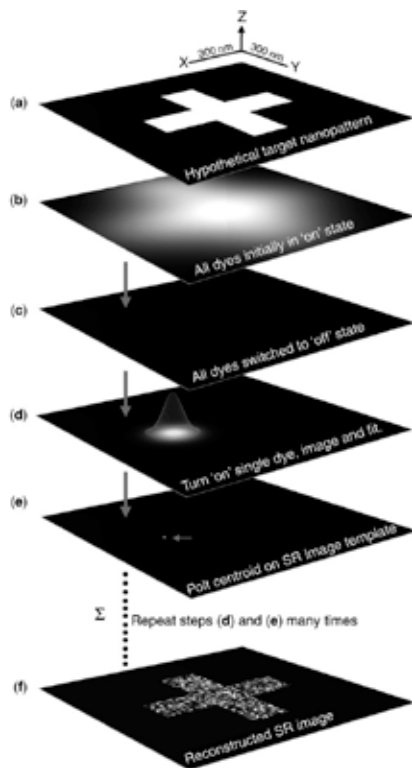

Figure 1. Illustration of the working principle in super resolution imaging by single molecule localization. (a) Hypothetical 1 micron wide target nanopattern densely labeled with fluorescent dyes. (b) Blurred, diffraction-limited wide-field image of nanopattern as it would appear if all dyes were in the "on" state. (c) All dye molecules turned to "off" state. (d) One molecule is stochastically turned back to the "on" state, imaged, and localized with a 2D Gaussian PSF. (e) The centroid coordinates of the spot are plotted on a SR image template as a stipple point (arrow). (f) After repeated imaging and localization, the evolving SR image contains enough stipple points to reconstruct the target nanopattern.



Figure 2. A cartoon comparing epi excitation and selective plane illumination. Selective plane illumination has less

photodamage, inherent Z-sectioning, and is orders of magnitude faster than confocal microscopy.

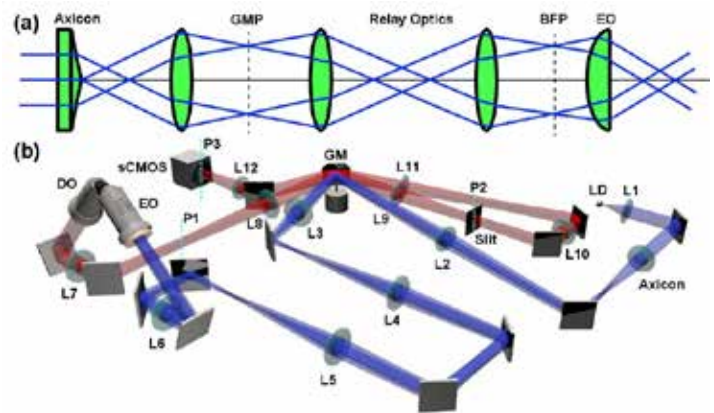

Figure 3. Confocal Bessel beam scanning microscope. (a) Beam path for the creation of a Bessel beam. GMP: galvo-mirror plane; BFP: back focal plane; and EO: excitation objective. (b) Schematic diagram of the experimental setup. LD: laser diode; GM: galvo-mirror; L: lens; DO: detection objective.

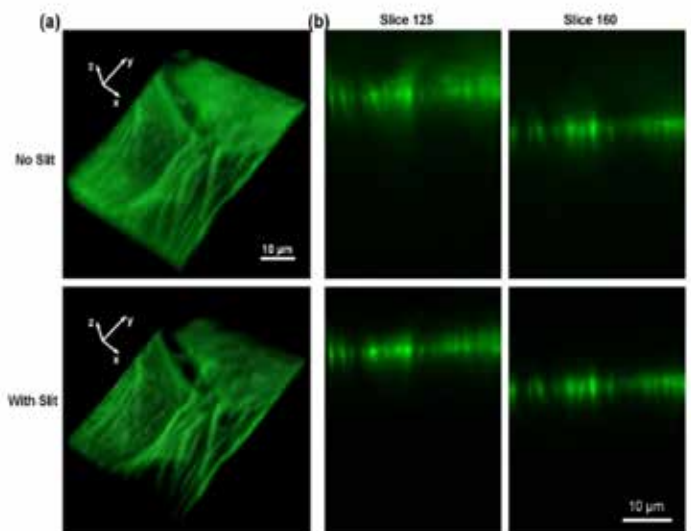

Figure 4. 3D imaging of fixed 3T3 cells with their actin labelled with Alexa Fluor® 488 Phalloidin. (a) 3D volume rendering from 300 slices with z-step size of 100 nm without (top) or with (bottom) spatial filter. (b) Two typical image slices taken without (upper row) and with (lower row) spatial filter. All images in (b) are in the same scale and the scale bar is 10 µm.

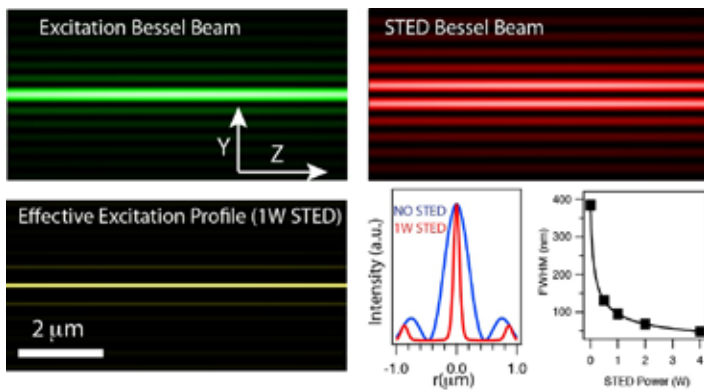

Figure 5. Calculation Results for Bessel Beam Stimulated Emission Depletion microscopy. Top Left: J_0 Excitation beam in the YZ plane. Top Right: J_1 STED beam profile in the YZ plane. Lower Left: Effective excitation profile in the YZ plane for 1W of STED power. Lower Right: Line scans across effective excitation profile for 0 and 1W of STED power and a plot of the full width half maximum (FWHM) for STED powers ranging from 0 to 4W.

References

- Zhang, P., P. M. Goodwin, and J. H. Werner. Fast, super resolution imaging via Bessel-beam stimulated emission depletion microscopy. *Optics Express*. 22 (10): 12398.
- Betzig, E.. Imaging intracellular fluorescent proteins at nanometer resolution. *Science*. 313 (5793): 1642.
- Rust, M. J.. Sub-diffraction-limit imaging by stochastic optical reconstruction microscopy (STORM). *Nature Methods*. 3 (10): 793.
- Huang, B.. Three-dimensional super-resolution imaging by stochastic optical reconstruction microscopy. *Science*. 319 (5864): 810.
- Shtengel, G.. Interferometric fluorescent super-resolution microscopy resolves 3D cellular ultrastructure. *Proceedings of the National Academy of Sciences*. 106 (9): 3125.
- Thompson, R.. Precise nanometer localization analysis for individual fluorescent probes. 2002. *Biophysical Journal*. 82 (5): 2775.
- Han, J. J., A. P. Shreve, and J. H. Werner. Super-Resolution Optical Microscopy. 2012. In *Characterization of Materials*. Edited by Kaufmann, E. L.. Vol. II, Second Edition, p. 1026. New York: Wiley.
- Denk, W.. Two-photon laser scanning fluorescence microscopy. *Science*. 248 (4951): 73.
- Huisken, J.. Optical sectioning deep inside live embryos by selective plane illumination microscopy. *Science*. 305 (5686): 1007.
- Planchon, T.. Rapid three-dimensional isotropic imaging of living cells using Bessel beam plane illumination. 2011. *Nature Methods*. 8 (5): 417.
- Zhang, P., P. M. Goodwin, and J. H. Werner. Fast, 3D imaging via confocal line scanning of a Bessel beam using a single galvo mirror. 2014. *Proceedings of the SPIE*. 8947: 1.
- Zhang, P., M. L. Phipps, P. M. Goodwin, and J. H. Werner. Confocal line scanning of a Bessel beam for fast 3D Imaging. 2014. *Optics Letters*. 39: 3682.
- Hell, S. W., and J. Wichmann. Breaking the diffraction resolution limit by stimulated emission: stimulated-emission-depletion fluorescence microscopy. 1994. *Optics Letters*. 19: 780.
- Zhang, P., P. M. Goodwin, and J. H. Werner. Interferometric 3D single molecule localization microscopy using a single high numerical-aperture objective . To appear in *Applied Optics*.

Publications

- Han, J. J., Y. A. Kunde, Hong-Geller, and J. H. Werner. Actin restructuring during *Salmonella typhimurium* infection investigated by confocal and super-resolution microscopy. 2014. *JOURNAL OF BIOMEDICAL OPTICS*. 19 (1).
- Han, J., A. Shreve, and J. Werner. Super-Resolution Optical Microscopy. 2012. In *Characterization of Materials (Volume 2)*. Edited by Kaufmann, E. , p. 1026. New York: Wiley.
- Zhang, , M. E. Phipps, P. M. Goodwin, and J. H. Werner. Confocal line scanning of a Bessel beam for fast 3D Imaging. 2014. *OPTICS LETTERS*. 39 (12): 3682.
- Zhang, , P. M. Goodwin, and J. H. Werner. Fast, super resolution imaging via Bessel-beam stimulated emission depletion microscopy. 2014. *OPTICS EXPRESS*. 22 (10): 12398.
- Zhang, , P. M. Goodwin, and J. H. Werner. Fast, 3D imaging via confocal line scanning of a Bessel beam using a single galvo mirror. 2014. *IMAGING, MANIPULATION, AND ANALYSIS OF BIOMOLECULES, CELLS, AND TISSUES XII*. 8947.
- Zhang, P., P. M. Goodwin, and J. H. Werner. Interferometric 3D single molecule localization microscopy using a single high numerical-aperture objective. To appear in *Applied Optics*.

Lanthanum Bromide Glass Ceramics for Gamma-Ray Spectroscopy

Markus P. Hehlen
20120246ER

Abstract

Gamma-ray scintillators are essential for the detection and identification of nuclear materials in a wide range of applications. The most efficient gamma-ray scintillators are crystals of rare-earth-doped halides (such as $\text{LaBr}_3:\text{Ce}^{3+}$ or $\text{SrI}_2:\text{Eu}^{2+}$) that are extremely hygroscopic and difficult to grow in the desired large sizes. This project focused on nanocomposite scintillators as an alternative to single-crystal scintillators. Nanocomposites consist of a high density of small scintillator particles that are dispersed within a solid transparent matrix. The primary challenges were (1) to create a high density of rare-earth-doped halide nanoparticles within an oxide matrix and (2) to minimize light scattering by creating particles of <10 nm diameter and/or matrices with high refractive index. We found that the various traditional “particle-in-matrix” approaches are unsuited for fabricating practical halide-based nanocomposite scintillators. These strategies suffer from chemical incompatibilities and insufficient volume fraction of the scintillator. We discovered that the opposite process of first creating a mesoporous (2-50 nm pore size) oxide followed by a separate infusion with scintillator melt had several key advantages. We developed the respective synthesis process and demonstrated, for the first time, cubic-centimeter-scale mesoporous monoliths of silica, alumina, and mixed $\text{SiO}_2\text{-TiO}_2$ having pore sizes of 3-5 nm. We successfully infused these materials quantitatively with melts of $\text{LaBr}_3:\text{Ce}^{3+}$ and $\text{SrI}_2:\text{Eu}^{2+}$ scintillator to form nanocomposite halide scintillators having high (52% by volume) scintillator loading.

Background and Research Objectives

Radiation sensors for the detection and identification of nuclear materials require gamma-ray scintillators with high photon yield, good energy resolution, and short decay time. Rare-earth-doped halide crystals are particularly suited [1, 2]. One example is cerium-doped lanthanum bromide ($\text{LaBr}_3:\text{Ce}^{3+}$), which has been the “gold standard” among room temperature scintillators for over

a decade [3]. Such rare-earth halide crystals however are extremely hygroscopic (water sensitive) and difficult to grow in the desired large sizes [4]. The resulting high cost, limited size, and few suppliers restrict their use to a small number of specialized detectors. What is needed is a gamma-ray scintillator that has $\text{LaBr}_3:\text{Ce}^{3+}$ performance but is chemically inert, mechanically rugged, and can be grown in large size.

Nanocomposite scintillators are a potential alternative class of materials that has been considered for some time. We have recently reviewed this research field in an invited 53-page book chapter [5]. Nanocomposites consist of a high volume density of small scintillator particles that are dispersed within a solid transparent matrix that can be organic (such as a polymer) or inorganic (such as a glass). Generally there is a mismatch between the refractive indices of the scintillator particles and the matrix, which results in scattering and subsequent loss of scintillator light by self-absorption by the chromophore (e.g. Ce^{3+} or Eu^{2+}). However, if the particles have diameters of <10 nm, this loss can theoretically become sufficiently low with the effect that the nanocomposite becomes optically transparent and the scintillator light can efficiently emerge from the material to be detected by an external photo-detector [5]. In 2007, McKigney and co-workers at LANL have demonstrated a nanocomposite scintillator that used $>50\%$ by volume cerium-doped lanthanum fluoride ($\text{LaF}_3:\text{Ce}^{3+}$) dispersed as 10-nm particles in oleic acid [6, 7]. These nanocomposites had fairly high optical transparency because the relatively low refractive index of $\text{LaF}_3:\text{Ce}^{3+}$ ($n=1.63$) could be well matched by the oleic acid. $\text{LaF}_3:\text{Ce}^{3+}$ was also chosen because it is favorably non-hygroscopic and therefore easy to process. Unfortunately however, it is a rather inefficient scintillator and resulted in a nanocomposite with poor energy resolution (16.5% at 662 keV) and thus limited promise for use in applications.

The goal of this project was to demonstrate, for the first

time, a nanocomposite scintillator consisting of highly efficient but very hygroscopic rare-earth halide scintillators such as $\text{LaBr}_3:\text{Ce}^{3+}$ or europium-doped strontium iodide ($\text{SrI}_2:\text{Eu}^{2+}$) by embedding the halide scintillator nanoparticles into a non-hygroscopic rugged oxide matrix. Besides the pronounced hygroscopicity, the high refractive index of the rare-earth halide scintillators ($n=2.3\text{--}2.4$) posed the additional daunting challenge of having to fabricate particles with diameters <2 nm and/or finding a matrix with similarly high refractive index. If successful, such a nanocomposite material would have the photon yield desired by detector applications and also be chemically inert, mechanically rugged, and potentially scalable to large size.

During the course of this project we concluded that the various traditional “particle-in-matrix” approaches, including our initially proposed non-hydrolytic sol-gel (NHSG) method, are unsuited for fabricating practical halide-based scintillators. All these strategies suffer from chemical incompatibilities and/or insufficient volume fraction of the scintillator. We discovered that the opposite process of first creating a mesoporous (2–50 nm pore size) inert oxide template followed by infusion with scintillator melt had several key advantages. We developed the respective synthesis process and were able to demonstrate, for the first time, cubic-centimeter-scale mesoporous monoliths of silica, alumina, and mixed $\text{SiO}_2\text{--TiO}_2$. We successfully infused these materials quantitatively with melts of $\text{LaBr}_3:\text{Ce}^{3+}$ and $\text{SrI}_2:\text{Eu}^{2+}$ scintillator to form nanocomposite halide scintillators with high (52% by volume) scintillator loading, thus accomplishing one of our primary research objectives.

Scientific Approach and Accomplishments

The original approach was to dissolve $\text{LaBr}_3:\text{Ce}^{3+}$ scintillator in silica alkoxides, polymerize the alkoxides via sol-gel process to form a silica network, and to precipitate $\text{LaBr}_3:\text{Ce}^{3+}$ nanoparticles in situ at elevated temperature to form the nanocomposite scintillator. The traditional silica alkoxide sol-gel chemistry was unsuited in our case because it involves water that would have readily reacted with the hygroscopic $\text{LaBr}_3:\text{Ce}^{3+}$ scintillator to form undesired cerium oxybromide, hydroxide, or oxide. We therefore set out to synthesize the nanocomposite by a NHSG process in which silica-networks are formed in the absence of water [8]. The first experiments focused on demonstrating the basic NHSG process without the addition of $\text{LaBr}_3:\text{Ce}^{3+}$. We were able to successfully synthesize transparent silica gels by reacting methyl-trichlorosilane (MeSiCl_3) with methyl-triethoxysilane ($\text{MeSi}(\text{OEt})_3$) or tetra-methyl-orthosilicate (TMOS) at 110 °C in the presence of FeCl_3 or ZrCl_4 catalyst followed by slow gelation over the period of several days. Incorporation of a cerium fluoride into this sol-gel process was achieved by

using trifluoroacetic acid (TFA) as a fluoride donor, resulting in nanocomposites with fluorine content of up to 22 at.% that were thermally unstable above 250 °C [9]. An analogous bromide donor is not available, and we thus proceeded to add the $\text{LaBr}_3:\text{Ce}^{3+}$ component directly to the sol-gel precursors. Its solubility in the initial $\text{MeSiCl}_3\text{--MeSi}(\text{OEt})_3$ solution itself however was very low, which required us to identify a solvent for dissolving $\text{LaBr}_3:\text{Ce}^{3+}$ into the monomer reaction mixture. The first solvent we tested was the ionic liquid 1-ethyl-3-methylimidazolium bis(trifluoromethanesulfonyl)amide in conjunction with TMOS as the alkoxide and various catalysts (FeCl_3 , formic acid, and/or sulfuric acid) for polymerization. We observed the expected formation of a transparent gel and thus successfully demonstrated the concept of our proposed base-line reactions. We found that the gelation required undesirably large amounts of catalyst that, together with the ionic liquid, was incorporated into the final gel and caused the material to decompose at the higher temperatures needed for the subsequent precipitation of the $\text{LaBr}_3:\text{Ce}^{3+}$ nanoparticles. Furthermore, the solubility of $\text{LaBr}_3:\text{Ce}^{3+}$ in the ionic liquid proved to be too low. An exhaustive search involving many solvents was carried out (e.g. anhydrous methanol, toluene, and acetonitrile-trichlorosilane) over a range of process temperatures but the experiments only yielded gels that decomposed and/or had limited $\text{LaBr}_3:\text{Ce}^{3+}$ solubility. We had to conclude that the solubility of rare-earth halides was too low in any of the NHSG chemistries to achieve the required large mass fraction of $\text{LaBr}_3:\text{Ce}^{3+}$ needed for the final application.

So far, all approaches to nanocomposite scintillators considered in the literature and initially by us involved either suspension or in situ growth of scintillator particles in a transparent matrix. Besides the chemical constraints imposed by the hygroscopicity of the halides, the often large refractive-index mismatch between the scintillator particles and the matrix also forced these approaches to create un-agglomerated and challengingly small scintillator particles in order to achieve sufficiently low light scattering. Given the limited success with this approach, we discovered and developed the novel and opposite strategy illustrated in Figure 1. Our new approach was to create a nanocomposite scintillator by first synthesizing a mesoporous oxide material having a network of open pores with pore sizes in the 4–10 nm range (Figure 1a), followed by a separate step of infusing the mesoporous “foam” with molten scintillator such as $\text{LaBr}_3:\text{Ce}^{3+}$ or $\text{SrI}_2:\text{Eu}^{2+}$ (Figure 1b), to ultimately produce a nanocomposite scintillator (Figure 1c). This approach has several key advantages over the traditional “particle-in-matrix” approach: (1) it decouples the synthesis of the mesoporous matrix from the infusion of the matrix with the scintillator and thus avoids

many of the chemical incompatibilities, (2) it offers a high volume fraction for the scintillator, and (3) it can yield mesoporous matrices with a high refractive index that is better matched to that of the rare-earth halides.

We succeeded in synthesizing monoliths of mesoporous silica (SiO₂), alumina (Al₂O₃), and mixed SiO₂-TiO₂. Mesoporous silica was synthesized from a mixture of TEOS, ethanol, and a Pluronic (F127) block co-polymer as a surfactant by an acid-catalyzed reaction at 70 °C. Cross-linking of the network occurred by slow evaporation of the ethanol, producing a two-phase solid consisting of an [Si-O-Si] network and surfactant. The latter is burned off by heating the material to 550 °C in air for 6 hours, yielding a mesoporous silica monolith with an open pore structure suited for subsequent melt infusion. An analogous process using aluminum-isopropoxides precursor and a mixture of CTAB (cetyltrimethylammonium bromide) and PEG (polyethylene glycol) surfactants were used successfully for the fabrication of monolithic mesoporous alumina. However, the same process was impractical for the fabrication of mesoporous samples containing titania because of the 2-3 orders of magnitude greater reactivity of titanium alkoxides compared to TEOS. Instead, the synthesis of mixed SiO₂-TiO₂ mesoporous monoliths used titanium isopropoxide and TEOS precursors in an equimolar ratio, ethanol as a solvent, acetic acid as inhibitor, and Pluronic (F127) as surfactant in an acid-catalyzed reaction (HCl). The reaction was carried out at 35 °C over the course of 1 week under flowing air, followed by heating to 70 °C for 48 hours for final cross-linking and drying. The resulting two-phase solid was then converted to mesoporous SiO₂-TiO₂ by heating to 550 °C for 6 hours in air. Samples as large as 1-2 cm³ were fabricated (Figure 2a), and the process is suited for scaling to even larger size in the future. This type of reaction is referred to as evaporation-induced self-assembly (EISA) in which the careful choice of reactant concentrations, temperature, and evaporation rates allows for the formation of a monolithic instead of a powder sample. To our knowledge, these are the largest mesoporous SiO₂-TiO₂ monoliths ever produced. The SiO₂-TiO₂ material was of particular relevance to our studies because its constituents have bulk refractive indices of $n=1.56$ and $n\approx 2.8$ (anatase phase), respectively, at the LaBr₃:Ce³⁺ emission wavelength of 390 nm. The estimated average refractive index for mesoporous SiO₂-TiO₂ is $n\approx 2.2$, which is close to the $n=2.3-2.4$ refractive index of LaBr₃:Ce³⁺ and would help reduce optical scattering.

The pore size and surface area of the synthesized mesoporous monoliths were measured by a nitrogen physisorption method, which builds on the BET (Brunauer-Emmett-Teller) theory. The sample was first degassed at an elevated

temperature (typically 250 °C) under vacuum to remove any adsorbed water or other gas. Then the sample was filled with nitrogen gas that is subsequently removed, all while monitoring the pressure, resulting in an isotherm. This data is modeled by the BET theory to determine the pore size distribution and surface area. The mixed SiO₂-TiO₂ mesoporous monoliths were found to have a very high surface area of 308.4 m²/g. The measured pore size distribution of this material is presented in Figure 2b and shows a mean pore size of 4.0 ± 1.0 nm. From these measurements, the void volume was calculated to be 0.2011 cm³/g, which corresponds to a favorably high fractional pore volume of $\sim 52\%$ available for infusion with scintillator.

The mesoporous monoliths were infused by soaking them in a melt of LaBr₃:Ce³⁺, pure CeBr₃, or SrI₂:Eu²⁺ for several hours at 850 °C, which is above the melting points of the halides but below the softening point (~ 1100 °C) of the mesoporous monolith. The melt infusion was initially carried out in quartz crucibles under argon atmosphere and at ambient pressure. The SiO₂-TiO₂ monoliths became slightly silvery in appearance and remained optically opaque after infusion with the melt. Figure 3a (inset) shows a mesoporous silica monolith infused with LaBr₃:Ce³⁺. BET physisorption analysis of the infused samples indicated that the melt infiltration into the mesoporous scaffold was quantitative and that we had successfully fabricated a rare-earth-halide nanocomposite containing $\sim 52\%$ by volume of scintillator material. However, the BET method is insensitive to voids < 2 nm and cannot detect residual small voids that were present due to incomplete infusion and/or voids that formed upon melt solidification. Such residual voids may be the cause for the remaining opacity of the infused monoliths. The x-ray excited luminescence spectrum and excited-state decay transient of a mesoporous silica monolith infused with LaBr₃:Ce³⁺ are shown in Figures 3a and 3b, respectively. These properties were found to be in good agreement with those of the respective bulk compound, indicating that the scintillators largely retained their desired properties upon infusion into the mesoporous matrix. The residual opacity of the samples prevented us from measuring the scintillation performance under irradiation with an external gamma source, because excessive scattering and self-absorption attenuates the emitted scintillation light and broadens the characteristic features in the scintillation pulse-height spectrum. In an attempt to reduce residual < 2 nm voids, we infused SiO₂-TiO₂ monoliths with LaBr₃:Ce³⁺ and SrI₂:Eu²⁺ at high pressure (200 psi) at 850 °C using an inert atmosphere reactor vessel. High pressure melt infusion has been shown to more effectively fill pores in powdered porous materials, but has not been demonstrated in larger monolithic materials. The very first results were encouraging but did not immediately

reduce the opacity.

The team published seven papers in peer-reviewed journals, gave three presentations at conferences, and was invited to write a book chapter. Three additional manuscripts will be ready for submission shortly. We also submitted a LANL invention disclosure (IDEA 14-00002).

Impact on National Missions

Scintillators are currently used in numerous radiation detection systems for basic science, medical imaging, non-destructive evaluation, and radiation detection. The mesoporous scintillators developed in this project directly benefit all of these areas. We have discovered a novel class of mesoporous materials that have opened up a new and highly promising avenue for nanocomposite scintillators. While light scattering remains to be further improved, this new material platform could be scaled to the large sizes desired by the various application areas. This could break the price-performance correlation in radiation detection materials by breaking the single crystal-performance correlation. Furthermore, this scalable synthesis technique is not limited by the intrinsic properties of the bulk scintillator and thus has the potential to produce radiation detector materials at significantly lower cost yet having a performance rivaling that of the best crystal scintillators. This is of interest to our homeland security, nuclear non-proliferation, and space systems customers.

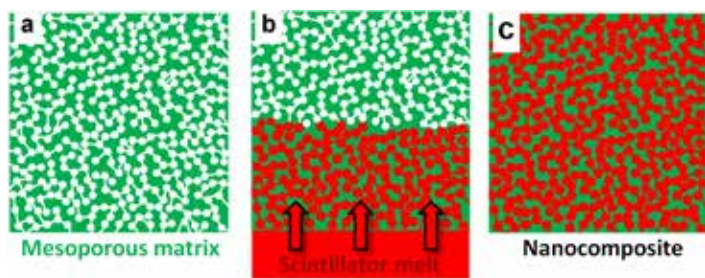

Figure 1. Illustration showing the fabrication of an infused mesoporous nanocomposite scintillator first developed and demonstrated on the cubic-centimeter-scale in this project.

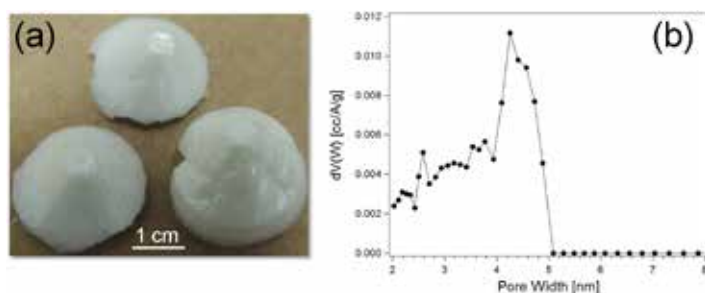

Figure 2. (a) Picture of three mixed $\text{SiO}_2\text{-TiO}_2$ monoliths before melt infusion; (b) pore-size distribution of a mixed $\text{SiO}_2\text{-TiO}_2$ monolith as measured with nitrogen physisorption.

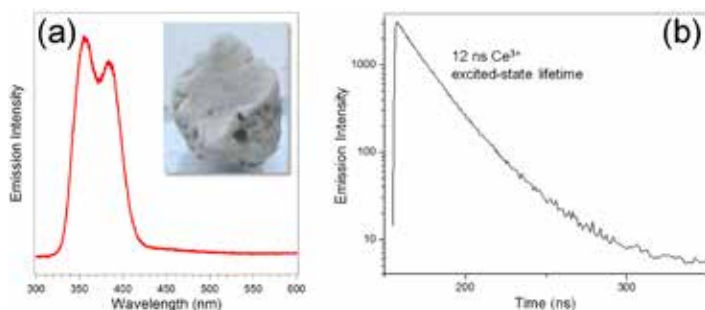

Figure 3. A (inset) shows a mesoporous silica monolith infused with $\text{LaBr}_3\text{:Ce}^{3+}$. The x-ray excited luminescence spectrum and excited-state decay transient of a mesoporous silica monolith infused with $\text{LaBr}_3\text{:Ce}^{3+}$ are shown in A and B respectively.

References

1. Birowosuto, M. D., and P. Dorenbos. Novel gamma- and X-ray scintillator research: on the emission wavelength, light yield and time response of Ce^{3+} doped halide scintillators. 2009. Phys. Status Solidi A. 206 (1): 9.
2. Alaribe, L., C. Disch, A. Fauler, R. Engels, E. Keller, A. Cecilia, T. dos Santos Rolo, E. Hamann, and M. Fiederle. $\text{SrI}_2\text{:Eu}^{2+}$ -scintillators for spectroscopy and X-ray imaging applications. 2012. IEEE Trans. Nucl. Sci.. 59 (5): 2193.
3. Weber, M. J.. Inorganic scintillators: today and tomorrow. 2002. J. Lumin.. 100: 35.
4. Higgins, W. M., A. Churilov, E. van Loef, J. Glodo, M. Squillante, and K. Shah. Crystal growth of large diameter $\text{LaBr}_3\text{:Ce}$ and CeBr_3 . 2008. J. Cryst. Growth . 310: 2085.
5. Hehlen, M. P., N. A. Smith, M. W. Blair, A. Li, S. Stange, R. D. Gilbertson, E. A. McKigney, and R. E. Muenchausen. Nanocomposite scintillators. Nanocomposite, ceramic and thin-film scintillators. Edited by Nikl, M..
6. McKigney, E. A., R. E. Muenchausen, D. W. Cooke, R. E. del Sesto, R. D. Gilbertson, M. K. Bacrania, B. L. Bennett, L. G. Jacobsohn, T. M. McCleskey, K. C. Ott, S. C. Sitarz, J. F. Smith, and S. Stange. $\text{LaF}_3\text{:Ce}$ nanocomposite scintillator for gamma-ray detection. 2007. Proc. SPIE. 6706: 67061A.
7. McKigney, E. A., R. E. del Sesto, L. G. Jacobsohn, P. A. Santi, R. E. Muenchausen, K. C. Ott, T. M. McCleskey, B. L. Bennett, J. F. Smith, and D. W. Cooke. Nanocomposite scintillators for radiation detection and nuclear spectroscopy. 2007. Nuc. Instr. Meth. Phys. Res. A. 579: 15.
8. Lind, C., S. D. Gates, N. M. Pedoussaut, and T. I. Baiz.

Novel materials through non-hydrolytic sol-gel processing: Negative thermal expansion oxides and beyond. 2010. *Materials* . 3: 2567.

8. Lakshminarayana, G., J. A. Torres, T. C. Lin, I. V. Kityk, and M. P. Hehlen. Sol-gel synthesis and characterization of fluoride-rich lanthanum-alumino-silicate gels doped with Ce³⁺ and Ti⁴⁺. 2014. *J. Alloys Comp.* 601: 67.

Publications

Blair, M. W., M. Fasoli, S. C. Tornga, A. Vedda, N. A. Smith, B. L. Bennett, M. P. Hehlen, and R. E. Muenchausen. Nanophosphor GdOBr:Ce via combustion synthesis: luminescence results. 2013. *PHYSICA STATUS SOLIDI C: CURRENT TOPICS IN SOLID STATE PHYSICS, VOL 10, NO 2*. 10 (2): 227.

Measurement of Pressure and Temperature in Thermal Explosions

Markus P. Hehlen
20120247ER

Abstract

The knowledge of the spatial distribution of pressure and temperature inside a thermal explosion is key to understanding the mechanisms of ignition, subsonic burning (deflagration), and the final transition to a violent response of plastic bonded explosives. Such measurements are particularly challenging during the final microseconds of a dynamic event where temperatures of >1000 oC and pressures of hundreds of MPa can be present. The goal of this project was to develop all-optical sensors for pressure and temperature that can advance into a parameter space currently inaccessible by commercial sensor technology. We have successfully developed a pyrometric fiber-optic temperature sensor with microsecond response, sub-millimeter spatial resolution, and >1000 oC capability. The sensor was tested successfully in a thermal explosion of PBX9501, meeting the primary objective of the project. We also developed an all-optical pressure sensor and tested it on a load frame up to a pressure of 100,000 psi. The pressure sensor has not been fielded in a thermal explosion yet. This new diagnostic tool will benefit LANL and the explosives community as a whole by enabling new scientific discovery in the field of high explosives and providing previously unavailable data to ongoing programs that address performance, safety, and accident scenarios of our nuclear weapons and conventional munitions stockpile.

Background and Research Objectives

Pressure (P) and temperature (T) are the key quantities that enable a detailed understanding of the mechanisms of ignition, deflagration, and the final transition to a violent response of plastic bonded explosives such as 9501 (HMX) or 9502 (TATB) [1]. Pressures of hundreds of MPa and temperatures >1000 oC develop during the final few microseconds of a thermal explosion. Conditions are even more violent in the supersonic regime of detonation. Commercial pressure sensors are not sensitive enough in this regime, are unable to withstand the high temperatures, and provide only case pressure rather

than local pressure. Likewise, the use of commercial thermocouples is limited as their signal is overwhelmed by RF noise due to plasma formation during final stages of a thermal explosion. Exhaustive examinations over the past years have found commercial P/T technologies to be unsatisfactory. The goal of this project was to develop all-optical sensors for pressure and temperature that (1) have high spatial resolution, (2) offer microsecond time resolution, (3) are immune to RF noise, (4) can place the detection system remotely from the sensor head, and (5) can be implemented reliably and cost-effectively. Such sensors would provide the long-sought quantitative framework to test and validate High Explosive Violent Response (HEVR) and Deflagration-to-Detonation Transition (DDT) models. Internal P/T measurements under these conditions would be the first step towards a full understanding of HEVR and enable the predictive simulation of this phenomenon for the first time.

The team successfully developed P and T sensors on parallel project tracks. The initial approach of creating a T-sensor with an erbium-doped fiber had insufficient sensitivity at temperatures >300 oC; however, it offered excellent performance at cryogenic temperatures. It has since sparked the interest of scientists and engineers engaged in high magnetic field experiments such as those carried out at the National High Magnetic Field Laboratory (NHMFL). An alternate design using the thermal emission of silicon carbide (SiC) nanopowder in a pyrometric configuration was found to have high sensitivity and reproducibility for temperatures >500 oC. This sensor was successfully fielded in a shot with 9501 (HMX-based) explosive, where it provided a clean and fast temperature signal well into the RF regime all the way up until 6 microseconds before loss of confinement. This result not only fully met our initial research objective for the T-sensor but has also generated interest with a sponsor for a possible follow-on development. We also developed a fiber-optic P-sensor based on a multilayer dielectric coating and demonstrated a sensitive response

up to a hydrostatic pressure of 100,000 psi produced on a load frame. This sensor has not been fielded in an explosives shot yet.

Scientific Approach and Accomplishments

All-optical temperature sensor

Our initial approach for an all-optical measurement of temperature was based on the temperature-dependent changes in the photoluminescence (PL) spectrum of commercial erbium-doped fibers. The approach was inspired by differential luminescence thermometry schemes previously reported in the literature [2]. Erbium-doped fiber primarily emits in the near infrared spectral region (1480-1650 nm), and it also has weak green upconversion emission (visible in Figure 1a inset). A short section of erbium-doped fiber (100-1200 micrometers long) was fusion spliced to a commercial single-mode fiber and excited with a 980 nm diode laser through the fiber. The resulting backward-propagating PL was split into two wavelength bands by a commercial thin-film filter, and the two bands were detected by an indium-gallium-arsenide (InGaAs) balanced photodetector that provided a signal proportional to the intensity difference of the two bands. Extensive studies of this sensor over the 20-1100 oC temperature range inside a furnace however found very low sensor sensitivity for temperatures >300 oC. This is because the Stark levels of the emitting excited state are nearly equally populated above 300 oC, and the PL spectrum therefore does not change much. This approach was deemed unsuited for the high temperatures encountered in thermal explosions. The erbium PL spectrum however changed significantly at low temperatures. Figure 1a shows the fiber sensor signal as a function of temperature down to 3 Kelvin. The fiber was mounted on a cryostat cold-finger and cycled twice from room temperature to 3 K, giving a strong and reproducible signal. We also measured its temporal response by rapidly immersing the sensor tip into liquid nitrogen. The sensor was able to record the 300 to 77 K temperature drop (Figure 1b), and the associated time constant was 200 ms. This dynamic response is limited by the formation of an insulating nitrogen gas layer around the fiber during the initial cooling rather than the fiber sensor itself. This T-sensor could find application in cryogenic high magnetic field experiments where thermocouples often give erroneous readings and all-optical sensors that are immune to magnetic fields are desired. Possible follow-on developments with the NHMFL are currently being explored.

The team then discovered that the same fiber-based approach with balanced photodiode detection could be used with a thermal emitter instead of a luminescent material. Thermal emission produces a rapidly changing spectral power distribution in the near-infrared spectral region

above 500 oC. Several key inventions were made to realize such a T-sensor based on this effect. First, a material with high thermal emissivity and high temperature stability had to be found. An extensive material search identified silicon carbide (SiC) as a suited candidate. SiC has a thermal emissivity of ~0.9 at 1627 oC at a wavelength of 2000 nm [3], is chemically inert, and has a high melting point of 2730 oC. Second, we developed a metal cap to go over the endface of the optical fiber. The cap not only contained the SiC powder into which the fiber was inserted but also prevented any external light from coupling into the fiber. This ensured that only light emitted by SiC was captured. Blocking external light is critical because it confines the measurement to the immediate sub-cubic-millimeter volume of the sensor tip to enable high spatial resolution. Furthermore, external light is generally not in thermal equilibrium and thus not a reliable measure of temperature because it contains fluorescence from excited matter. The sensor architecture is shown in Figure 2a. Each fiber cap was fabricated by electroplating the end of a 200-micrometer diameter silicon bronze wire with 100 micrometers of chromium (1907 oC melting point), annealing the plating, and acid etching the silicon bronze to leave a hollow chromium cap of 400 micrometer diameter. The raw cap was cut to a length of 770 micrometer length using electrical discharge machining (EDM) for a burr-free cut. Nanopowder of beta-SiC (45-55 nm particle size) was suspended in acetone, applied to a glass slide, and the acetone evaporated to form agglomerates of SiC nanoparticles that could be picked up with a thin wire and manually inserted into the chromium cap under an optical microscope. A multimode optical fiber was then inserted into the partially SiC-filled cap and secured with a high-viscosity UV-curable adhesive. Figure 2b shows an image of a fully assembled sensor. The optical sensing scheme is illustrated in Figure 2c. The thermal emission light from SiC in the cap is coupled into the core of the multimode fiber (can be many meters long to enable remote operation) and is split into two wavelength bands (>1500 nm and <1500 nm) by a dichroic mirror. Both bands were coupled into separate fibers and detected by a commercial balanced InGaAs photodiode pair that provided a voltage output of the amplified intensity difference of the two wavelength bands.

This T-sensor was first tested extensively under slow heating conditions in a furnace. Figure 3 summarizes the results of multiple experiments with the same sensor specimen. The initial configuration performed well but showed a slight variation between two consecutive heating runs (red/orange curves). The fiber system was then rigidly mounted on a breadboard, giving much improved stability and reproducibility (green/yellow curves). The mounting caused some change in the optical alignment, and the sys-

tem was realigned for the final furnace test runs (blue/turquoise curves). These experiments not only showed that the sensor and detector system had outstanding stability and run-to-run reproducibility but also proved that the sensor could survive many cycles from room temperature to 1000 oC without noticeable degradation.

One such T-sensor was then used for a dynamic experiment with 9501 explosive. For this purpose, two cylindrical pieces of 9501 were mounted inside an aluminum cylinder and enclosed between two aluminum plates (Figure 4b drawing). The midplane was equipped with several radially arranged thermocouples and the fiber optic temperature sensor (near the center). The assembly was placed inside a protective enclosure, and the temperature was raised to 207 oC over the course of 60 minutes by means of external heaters. Exothermic reactions became evident after 20 minutes at 207 oC, and the assembly went into thermal run-away and exploded after 32 minutes at 207 oC. Figure 4a shows the final 100 microseconds before complete disintegration of the assembly. During this final period, the fiber sensor first indicated a stable temperature of <400 oC (region i) in agreement with the thermocouple, then saw ignition in the form of RF noise (around -40 microseconds), followed by a rapid temperature rise (region ii) that went through two short plateaus (region iii) and peaked at -6 microseconds (region iv) before the assembly disintegrated at $t=0$. These measurements were accompanied by fast x-ray imaging. Figure 4b shows an x-ray image of the midplane area during ignition. The ignition volume is visible as a bright low-density zone at 3.2 mm above the midplane. The burn front had to propagate 3.2 mm from the ignition point to the sensor, which corresponds to the 20 microsecond delay observed between ignition and the temperature rise (Figure 4a). This indicates a burn velocity of 160 m/s in excellent agreement with typical convective burn front velocities of 160-250 m/s observed in other experiments. Note that the T-sensor signal is not currently calibrated and is given as a voltage in Figure 4a. Based on the furnace experiments (Figure 3) and assuming different sensor specimens to behave identically, we estimate that the sensor exceeded 950 oC at the last point (iv) in Figure 4a.

These results successfully demonstrate the key features of the pyroelectric fiber-optic temperature sensor: high spatial resolution, fast response, high immunity to RF, sensor reliability and reproducibility, and remote operation.

All-optical pressure sensor

We have developed a fiber-optic P-sensor by applying a multilayer dielectric coating to the endface of a single-mode optical fiber. The coating consisted of 10 bi-layers of yttria-stabilized zirconia (YSZ, 200 nm thick) and silica (SiO₂, 310 nm thick), giving the coating a pressure depen-

dent reflectance (R). A metal cap had to be applied over the fiber tip to block any external light. The pressure sensitivity (dR/dp) was achieved via the different compressibility (dx/dp) and pressure-dependence of the refractive index (dn/dp) of the two materials. Modeling was used to select the layer thicknesses such that the pressure sensitivity (dR/dp) was maximized while the temperature sensitivity (dR/dT) was minimized. Light from an amplified spontaneous emission (ASE) light source was launched into the fiber, back-reflected by the coating, and routed to a photodiode using a fiber-optic optical circulator. The primary challenge was that some of the light was transmitted through the coating and hit the inside of the metal cap. A special cap with an inside angle of 8 degrees was therefore fabricated (Figure 5a) to ensure that light transmitted by the coating and reflected inside the cap would not couple back into the fiber and disturb the reflectivity measurement. The P-sensor fiber tip was mounted inside a custom pressure cell that used silicone grease as a pressure medium and a Field's metal casting (Bi-In-Sn alloy) as a deformable plug (Figure 5b). A piezo-electric pressure transducer was also incorporated. Figure 5c shows the optical power reflected from the dielectric coating as a function of pressure up to 700 MPa ($\sim 100,000$ psi).

While this was a successful result, several challenges remained and prevented us from testing the sensor dynamically. First, there appeared to be slight variations between different P-sensors, with one behaving as shown in Figure 5c while others showing excessive optical interference probably because of mechanical deformation of the cap under pressure. Second, the optical adhesive inside the cap is only stable up to temperatures of ~ 300 oC and decomposes at higher temperatures, causing uncontrolled changes in the reflectivity signal. Further development is needed to achieve our initial goals of an all-optical pressure sensor for dynamic experiments.

The results of this research have been presented at the international Conference on Lasers and Electrooptics (CLEO) in 2012 and 2013. The team was also selected to present at the LDRD Day in 2012. Manuscripts on the cryogenic temperature sensor and on the pyroelectric temperature sensor will be submitted for publication shortly.

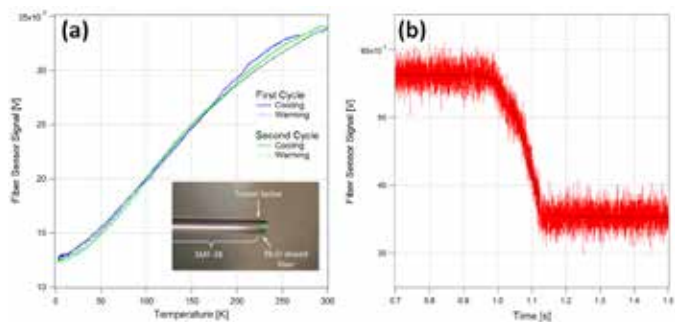

Figure 1. Cryogenic fiber-optic temperature sensor based on erbium-doped fiber. (a) Fiber sensor signal as a function of temperature for two consecutive cooling/heating cycles; the inset shows an image of the erbium-doped fiber (with green upconversion emission) spliced to a single-mode fiber. (b) <200 ms response time of the signal upon dropping the fiber from room temperature into liquid nitrogen.

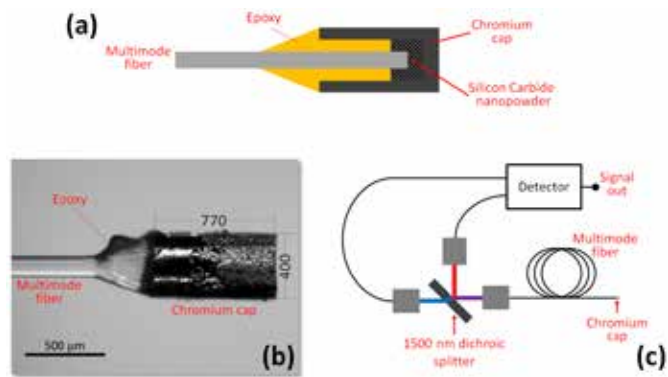

Figure 2. Pyrometric fiber-optic temperature sensor based on thermal emission of SiC nanopowder. (a) Schematic design of the sensor consisting of a multimode fiber embedded in SiC nanopowder within a chromium cap and secured with epoxy. (b) Image of the actual fiber sensor (dimensions in micrometers). (c) Schematic of the optical readout setup involving a dichroic splitter and an amplified balanced photodiode detector.

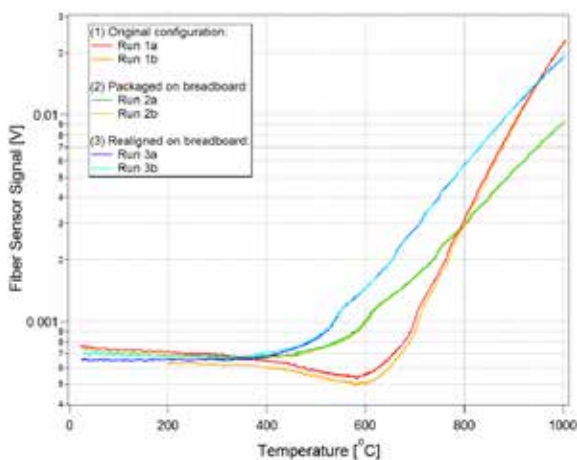

Figure 3. Response of the pyrometric fiber-optic sensor as a function of temperature measured by heating inside a furnace. Three consecutive experiments are shown. The fiber was heated twice for each experiment, demonstrating excellent signal reproducibility and stability.

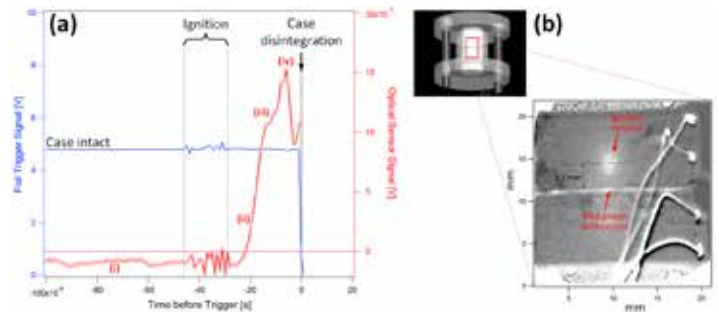

Figure 4. Temperature measurement at the center of a 9501 (HMX) high explosive during the final deflagration stage. (a) The temperature rises rapidly (stages ii, iii, iv) shortly after the ignition of the explosive (noisy period) and the fiber is destroyed (after iv) as the case disintegrates (step in blue trigger curve). (b) Drawing of the assembly and x-ray image of the central region at the time of ignition. The ignition occurred 3.2 mm above the mid-plane that contained the fiber-optic sensor.

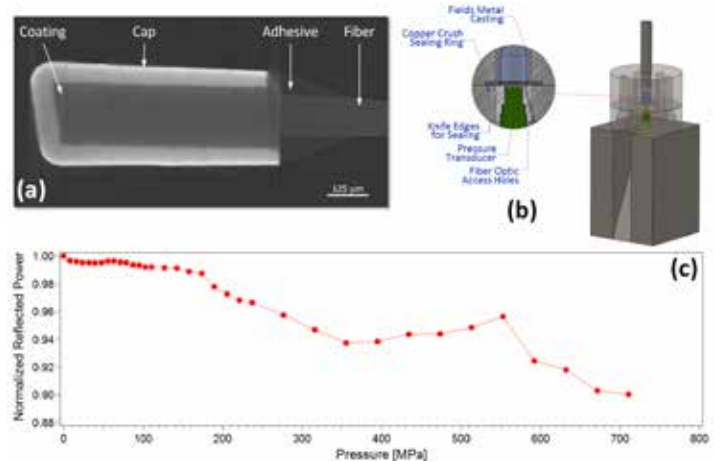

Figure 5. Pressure measurement using a fiber coated with an YSZ/SiO₂ multilayer reflector. (a) Computed x-ray tomography image of the assembled sensor showing the coated fiber inserted into a chromium cap with angled endface and secured with adhesive. (b) Custom pressure cell designed to create pressures up to 100,000 psi (690 MPa) on a MTS 880 load frame. (c) Optical power reflected by the fiber coating as a function of pressure.

Impact on National Missions

Intrinsic dynamic P/T measurements within a thermal explosion are not currently possible, yet this data is critical to the understanding of explosives response at both a fundamental and an applied level. The fiber-optic temperature sensor developed during this project in particular addresses this capability gap. This new diagnostic tool will benefit LANL and the explosives community as a whole by enabling new scientific discovery in the field of high explosives and providing previously unavailable data to ongoing programs that address performance, safety, and accident scenarios of our nuclear weapons and conventional munitions stockpile. It will also advance our multidisciplinary capability in measurement science and diagnostics under extreme conditions such as those pursued by MaRIE. The

temperature sensor will be utilized immediately in ongoing thermal explosion research (C and WX divisions) and help advance the deflagration models of 9501 and 9502 explosives. We are exploring other potential customers such as the HE Surety Program, HE Science Program, B61 LEP, DoD/DOE MOU, and the Joint Munitions Program.

References

1. Shock Wave Science and Technology Reference Library: Non-Shock Initiation of Explosives. 2010.
2. Patterson, W. M., D. V. Seletskiy, M. Sheik-Bahae, R. I. Epstein, and M. P. Hehlen. Measurement of solid-state optical refrigeration by two-band differential luminescence thermometry. 2010. *J. Opt. Soc. Am.* 27: 611.
3. Taylor, R. E., D. P. DeWitt, and P. E. Johnson. Spectral Emissivity at High Temperatures. 1980. Annual Report for AFOSR Grant 77-3280, School of Mechanical Engineering, Purdue University, West Lafayette, IN.

Publications

- Hehlen, M. P., B. W. Asay, G. R. Parker, L. B. Smilowitz, and B. F. Henson. Fiber-optic measurement of high temperatures with sub-millimeter spatial resolution. 2012. *CLEO Technical Digest*. : CM1F.6.
- Hehlen, M. P., G. R. Parker, A. M. Novak, P. Rae, G. Rivera, D. W. Schmidt, K. C. Henderson, B. M. Patterson, and L. B. Smilowitz. Fiber-optic point measurement of high pressures in thermal explosions. 2013. In *Conference on Lasers and Electro-Optics*. (San Jose, 9-14 June 2013). , p. CTu2H.6. Washington, DC: Optical Society of America.
- Hehlen, M. P., L. B. Smilowitz, G. R. Parker, A. M. Novak, M. D. Holmes, K. C. Henderson, G. Rivera, and D. W. Schmidt. Measuring Pressure and Temperature inside a Thermal Explosion. Invited presentation at LDRD Day 2013. (Pojoaque, NM, 23 October 2012).

Forensic Archaeology of a Manhattan Project Era Nuclear Site

Warren J. Oldham
20120459ER

Abstract

As concerns over nuclear proliferation and illicit nuclear activities grow, new strategies to effectively monitor nuclear facilities are needed. Distinguishing the low-level signatures of modern nuclear activities from the radionuclide background resulting from fallout of past atmospheric nuclear tests is a major challenge. Emissions controls and site remediation reduce actinide concentrations, making detection of the modern signature more difficult. The results of this research have shown that plutonium mobilized in the environment due to natural weathering processes is efficiently adsorbed onto the surface of rusty metal objects. Radiochemical analysis of the surface oxide coating found on discarded metal objects such as bottle caps or common nails can provide a sensitive indicator of nearby nuclear activities. In this project, rusty bottle caps of contemporary origin were collected from sites around northern New Mexico and were analyzed for trace plutonium contamination by isotope dilution inductively coupled plasma mass spectrometry (ICP-MS). Bottle caps collected from remote locations in northern New Mexico show plutonium isotopic ratios consistent with background global fallout ($^{240}\text{Pu}/^{239}\text{Pu} = 0.168 \pm 0.012$). In contrast bottle caps collected near the site of the former Manhattan Project Era plutonium facility (D building) reveal a unique isotopic signature indicative of the earliest plutonium manufactured as part of the U.S. war effort ($^{240}\text{Pu}/^{239}\text{Pu} = 0.0012$ to 0.0070). These results suggest that analysis of the surface oxide coating from rusty metal objects can provide a sensitive detection strategy to enhance the effectiveness of environmental monitoring programs.

Background and Research Objectives

The ubiquitous and persistent background resulting from fallout during the era of atmospheric nuclear testing complicates analytical detection of low-level emissions resulting from modern nuclear activities. An estimated 430,000 Ci of $^{239}+^{240}\text{Pu}$ activity was released into the atmosphere as a result of nuclear weapons testing. The

average $^{240}\text{Pu}/^{239}\text{Pu}$ isotopic ratio for stratospheric global fallout in the Northern Hemisphere is 0.18, corresponding to ~ 4.2 tons of ^{239}Pu and ~ 0.75 tons of ^{240}Pu released by these atmospheric tests. Even when dispersed over the entire globe, this plutonium background can significantly interfere with the detection of trace-level, modern plutonium releases.

Although plutonium is strongly associated with sediments and surface soils, it is potentially mobile in the environment, typically in the form of colloids or the soluble plutonyl species, $[\text{PuO}_2]^+$. Given this geochemical behavior, trace levels of plutonium mobilized in the environment through aqueous transport will likely be adsorbed onto the surface of rusty iron objects due to the reducing nature of the Fe/Fe $_2\text{O}_3$ system. Over time this geochemical behavior could serve to concentrate even trace levels of environmental Pu onto an easily analyzed metal surface. While this behavior is expected to apply to all sources of Pu in the environment, industrial sources (not released in an atmospheric nuclear test) might be more easily mobilized through natural weathering processes and could dominate the Pu inventory, overwhelming the background from global fallout. We hypothesized that if industrial effluents are more easily mobilized than global fallout, then analysis of the surface oxide coating of discarded metal objects could reveal a local source-term of interest. This idea was directly tested using a “case study” approach focused on the former site of the original Manhattan Project Era laboratories near Ashley Pond in Los Alamos.

Scientific Approach and Accomplishments

Locations around northern New Mexico were monitored for plutonium contamination through the collection and laboratory analysis of rusty metal objects. The surface oxide coating of the samples was dissolved in dilute hydrochloric acid; then the solution spiked with a ^{242}Pu tracer and purified using an efficient anion exchange procedure. The purified samples were analyzed using a

robust and highly sensitive technique called isotope dilution ICP-MS to determine the total number of atoms of ^{239}Pu and ^{240}Pu in the sample. The limit of detection for the method is on the order of $\sim 1 \times 10^7$ atoms, corresponding to only ~ 4 femtograms of plutonium per sample. The measurements were carried out in low-level radioanalytical facilities with rigorous attention to minimizing blank contamination and to quality control.

Rusty objects were analyzed from seven remote locations in northern New Mexico and southern Colorado. For these samples, the median ^{239}Pu concentration was 2.5×10^9 atoms, corresponding to a $^{239}\text{Pu}+^{240}\text{Pu}$ activity of 0.22 disintegrations per minute (dpm). The total number of ^{239}Pu atoms for each collection was found to be roughly proportional to the surface area of the sample. For example a small sample consisting of only two bottle caps was found to adsorb a minimum of 2.2×10^8 atoms of ^{239}Pu , whereas a rusty can collected from an adjacent area adsorbed up to 2.7×10^{10} atoms. The average $^{240}\text{Pu}/^{239}\text{Pu}$ atom ratio for these samples, collected far from any known nuclear activity, was 0.168 ± 0.012 , consistent with the plutonium isotopic composition reported for weapons testing fallout in this part of the United States. A minor contribution of regional fallout from the Nevada Test Site can be detected, resulting in $^{240}\text{Pu}/^{239}\text{Pu}$ values that are often lower than the northern hemisphere average of 0.18.

A set of bottle caps was also collected from the picnic area at Overlook Park in White Rock, NM, approximately 5 miles from Los Alamos National Laboratory. Eight samples were analyzed for plutonium, and with one exception, $^{240}\text{Pu}/^{239}\text{Pu}$ ratios ranged from 0.141 to 0.160. These values are considered normal for fallout in the area. Unexpectedly, $^{240}\text{Pu}/^{239}\text{Pu}$ was determined in one case to be 0.042 ± 0.003 , more consistent with weapons-grade plutonium (0.036-0.062). Although the absolute concentration for this set of samples was typical of samples collected within the entire region, the observed variability in isotopic composition suggests the possibility of significant heterogeneity in local plutonium contamination.

A large collection of discarded bottle caps was found within the main study area in the vicinity of former Manhattan Project Era laboratories near Ashley Pond in downtown Los Alamos. The original "D building" was located near the northern rim of Los Alamos canyon, which housed plutonium-processing operations between December 1943 and September 1945 and was later demolished. Today a modern parking lot covers the site. During environmental cleanup efforts in subsequent years, much of the soil from the area was removed and the site was completely remediated for unrestricted public access. Interestingly, these samples displayed only slightly elevated levels of pluto-

nium contamination compared to those retrieved from remote, seemingly pristine locations, with a median ^{239}Pu signal of 8.2×10^9 atoms per sample ($^{239}\text{Pu}+^{240}\text{Pu} = 0.47$ dpm). However, the isotopic composition of these samples varied dramatically from nuclear fallout.

The measured $^{240}\text{Pu}/^{239}\text{Pu}$ ratios varied for the samples as a function of distance from the former D building site. Samples collected across the street at Ashley Pond (~ 400 meters away, location 1, Figure 1) had a $^{240}\text{Pu}/^{239}\text{Pu}$ ratio of 0.050, while samples closer to the D building site (~ 50 meters away, locations 2 and 4) displayed lower $^{240}\text{Pu}/^{239}\text{Pu}$ ratios (0.012 to 0.014). Bottle caps collected from the surface of the paved parking lot that now covers the site (location 3) revealed $^{240}\text{Pu}/^{239}\text{Pu}$ atom ratios that ranged from 0.0012 to 0.0070. These unusually low $^{240}\text{Pu}/^{239}\text{Pu}$ atom ratios are a unique local signature that is characteristic of plutonium dating from the earliest years of the U.S. nuclear weapons program. Operations conducted in D building involved the first plutonium ever produced in the Hanford reactors, characterized by an extremely low ^{240}Pu concentration. Remarkably, this local signature is still evident today, almost 70 years after the closure of the building and after a complete site remediation was performed. These observations suggest that the analysis of metal oxide surfaces for trace plutonium represents a viable environmental sampling strategy to selectively identify local nuclear signatures. The approach has proven successful even when only trace-level contamination is present. Investigations of historic remediated sites related to the Manhattan Project are extremely valuable to test and develop methods for proliferation detection because they closely resemble the kind of technical circumstances that international monitoring efforts could likely encounter.

Impact on National Missions

Analytical methods that enhance the detection and isotopic characterization of trace-level plutonium in the environment support core mission capability in nuclear nonproliferation and treaty verification. In the future LANL may be tasked with monitoring compliance with additional international agreements including the Fissile Materials Cut-off Treaty and the Comprehensive Test Ban Treaty. The analytical and evaluation techniques pioneered in this research provide a technical foundation to position the laboratory as a credible national resource to support these expanded program requirements.

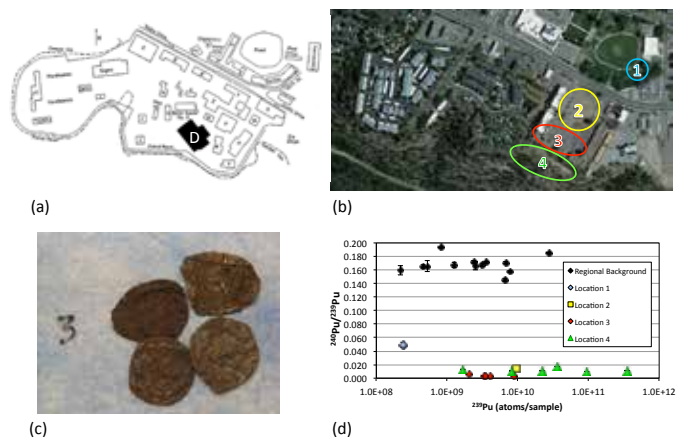

Figure 1. (a) Map of the original Manhattan Project Technical Area (TA-1). The plutonium processing facility (D Building) is highlighted in black. (b) Modern image from Google Earth. Sample collection locations are: 1-Ashley Pond, 2-vacant gravel lot, 3-paved parking lot, 4-Los Alamos canyon edge. (c) A typical sample analyzed for trace plutonium by ICP-MS. Bottle caps were collected from the paved parking area labeled as location 3. (d) Measured $^{240}\text{Pu}/^{239}\text{Pu}$ atom ratios for the collected samples are plotted as a function of ^{239}Pu atoms/sample. Rusty objects are representative of regional background (northern New Mexico) and within the boundaries of the former TA-1.

Publications

Oldham, W. J., B. S. Matteson, J. L. Miller, C. T. Lake, and M. Attrep. Rusty nails adsorb trace plutonium from the environment. 2013. JOURNAL OF RADIOANALYTICAL AND NUCLEAR CHEMISTRY. 296 (2): 889.

Threat Reduction via Nanomaterials: Engineering a Novel SERS Plat-form for Chemical Detection

Nathan H. Mack
20130416ER

Abstract

The detection of minute chemical signatures has applications that range from medical surveillance to airport baggage scanners. Additionally, toxic chemicals (and materials) and engineered chemical threat agents are a constant concern for military and first responder personnel. These widely varying needs in sensitivity, selectivity, portability, and ease of use have driven significant efforts across multiple agencies for an optical system that can rapidly identify chemical species with few false positives. By in large, no one solution has been able to address all of the detection community's needs, however, surface enhanced Raman spectroscopy (SERS) has often hinted at what a next generation sensing system may look like.

Attempts to utilize SERS for a low cost detection platform are continually hindered by the high cost of the nanostructured materials needed for the technique. In this work we propose to develop a novel nanostructured polymer-metal composite into a successful SERS based sensing platform, which is capable of detecting a wide variety of chemical agents using the fingerprint from their respective (enhanced) Raman spectra for identification. This technology is enabled by the spontaneous deposition of nanostructured metal particles on a conducting polymer thin film. These films are durable, stable, flexible, and can be produced in large quantities at exceedingly low costs. Perhaps most importantly, they have been demonstrated to enhance Raman signals of surface adsorbed molecules by >7 orders of magnitude.

This material has been engineered into an integrated benchtop Raman system and has demonstrated proof of concept detection of chemical warfare agent simulants. These efforts have moved towards the first widely deployable SERS based detection apparatus that has potential for emergency and military detection needs.

Background and Research Objectives

Surface enhanced Raman spectroscopy (SERS) has long promised to be the ultimate optical sensing technique, as it combines extreme sensitivity with molecular fingerprint identification, all with little to no chemical sample labeling or post processing.¹ Recent materials chemistry advances at LANL have produced SERS active materials with unprecedented sensitivity, uniformity, reproducibility, and mechanical properties that make them ideally suited for integration into a SERS based sensing platform. With an abundance of low cost, small form-factor Raman spectrometers commercially available, work to integrate SERS technology into a fieldable sensing device has the potential to make widespread SERS based sensing a reality. This work seeks to develop this polymer based SERS active material into a proven portable sensing device that would rival the current state of the art in terms of sensitivity and selectivity. This project has followed two primary thrusts:

- Benchtop demonstration of sensitivity, selectivity (distinct fingerprint spectra), and repeatability of chemical weapons (CW) simulant measurements using thin film formats.
- Portable Raman spectrometer engineering to integrate a Raman spectrometer with a low cost, robust, and manufacturable cartridge based SERS active material.

Over the past decade, many research groups have studied and developed SERS active materials for sensing applications that range from chemical warfare (CW) agents to biological discovery. The SERS technique uses a standard Raman spectrometer for sensing, but is unique in that analytes are bound to an engineered nanostructured metal (typically Au or Ag) surface. This results in polarizability and field enhancements that amplify the analyte's Raman signal by many orders of magnitude (10⁸ - 10¹⁰); a level at which single molecule detection

becomes a possibility. Unfortunately, previous work has only been demonstrated in the laboratory under tightly controlled conditions on Raman systems that are far from portable devices. Attempts to adapt these materials to a fieldable platform have been limited primarily due to the significant costs associated with fabricating reproducible nano-engineered surfaces, which typically require extensive lithographic processing.

Recent materials chemistry advances at LANL have resulted in conducting polymer based thin films that are able to spontaneously grow nanostructured metals on their surface from solutions of metal salts (Figure 1). These materials can be formed over large areas at extremely low cost and when exposed to model analytes that bind to the metal surface, have been demonstrated to reproducibly and uniformly enhance Raman signals by 8 orders of magnitude. Additionally, because the material is based on a polymer thin film, it opens up a wide variety of flexible form factors (films, ribbons, threads, etc.) for the SERS active area. These unique materials properties will enable a variety of sensing motifs – such as curved and flexible surfaces – that the vast majority of traditional silicon based SERS materials simply can not explore. We ultimately envision a SERS sensing platform that incorporates this polymer-metal into a form factor suitable for sample collection, analysis, and preservation.

Raman spectroscopy is a well established technique that is often implemented on the laboratory scale using a microscope on an optical bench; however, advances in solid state lasers and detection CCDs have dramatically reduced the overall dimensions of a fully operable Raman spectrometer. Current commercial designs can have dimensions on the order of a pack of playing cards, making them truly portable for ‘in the field’ applications. Unfortunately, intrinsic Raman has a small optical cross-section and therefore, without tremendous enhancement factors, Raman-based trace detection is not possible. Work to integrate a portable optical system with a low cost SERS active material is currently lacking. This work seeks to fill that gap and, for the first time, demonstrate the feasibility of a low cost SERS based sensing system designed for trace detection and positive identification of chemical threat agents.

Scientific Approach and Accomplishments

In this work we made efforts to engineer the two technologies into a single fieldable detection platform. Initial efforts focused on sensing CW simulants and building a spectral library of simulants with different chemical functionality. In parallel, we considered the feasibility of using several different types of off the shelf solid state spectrometers for data acquisition. The final, and perhaps most

challenging, phase of this work involved developing the SERS active material into a format suitable for integration into a sampling system. The materials development for this task was performed in tandem with the spectrometer engineering/modifications; each providing positive feedback, and dictating device designs with the highest probability of success.

As a complement to our laboratory Raman systems we pursued a portable Raman analyzer. The goal was to develop a capability that could be contrasted against the benchtop unit in a laboratory setting and also be field deployable. We set out with the goals to develop a system that could detect toxic industrial chemicals and materials (TICs and TIMs) that are precursors to chemical weapons as well as addressing the logistics of public safety and emergency mobilization. The success of this system would be based on its ability to surpass current methods in either quality of analysis or the number of independent samples it could catalog.

Based on these objectives, we created four requirements. The first limits the size and weight, as the entire system must be made for in-the-field use with a hand-held interrogator and processing system on-board or tethered from a pack. This implies battery operation and feedback to the user in the form of visual or audio recognition of Raman functionality. Next, the system must have the results collaborated with a benchtop analyzer. This requirement is met by using a standard laser wavelength such as 514nm, 785nm, or 1064nm. In addition, the wavenumber range of the acquired spectrums must be comparable to a benchtop system in order to evaluate peak detections by the spectrometer. The third requirement of the system applies to the collection medium and how the SERS substrates are utilized when taking samples. When the user has a medium, it must have a chain of custody and be verified. The portable system will give results in the field, but retaining the sample without destructive evaluation or loss permits post-processing and more advanced laboratory analysis. The last requirement is that the system provides “in-theatre” monitoring. The samples must be able to be cataloged in such a way that their position and time can be ascribed as metadata towards a spectrum file.

These requirements narrowed down our commercial options to about 6, from which we chose two; a B&W Tek NanoRam and a Rigaku Xantus-2. Representative spectra from these units are shown in Figure 1.

New portable spectrometers in hand, the rest of the project centered on engineering solutions to integrate our SERS substrates as well as optimum approaches to sampling. Initial measurements on CW simulants were constrained

to organophosphates with varying chemical functionality as shown in Figure 2. An aqueous solution of each simulant was prepared and then dropped onto the SERs substrate, which had been affixed to a glass microscope slide. Spectra were taken using the portable systems to assess sensitivity as well as look for overall fingerprint signatures that may be present in these molecules. For reference, each organophosphate was also sampled as a neat solution. Surprisingly, the SERS and neat Raman spectra were often different (Figure 2) with the neat spectra exhibiting additional stokes lines. This is likely the result of either hydrolysis in the aqueous solution as well as interaction with the SERs surface constraining active Raman modes in the bound molecule.

These signals from the SERs active surface led us to study if chemical reactions could be monitored in real time on the surface of a metal particle (Figure 3). Using a flow cell and our SERs active nanocomposite, we were able to successfully modulate the coupling of two amino-benzenthioi molecules into a single azo coupled complex. This is one of the first demonstrations of a plasmonically enhanced surface chemical reaction and opens these materials to numerous catalytic applications. This may also explain why our neat organophosphate spectra were so different from their SERs counterparts, and why many of the SERs spectra looked very similar regardless of the organophosphate used. The SERs material may be catalyzing the hydrolysis of the organophosphate to simply produce phosphoric acid at the surface. More study will be needed before this is verified.

As a demonstration of sensitivity, spectra were taken of acephate solutions with varying concentrations from 100mM down to 1mM. As can be seen in Figure 4, the spectrometers performed as expected when observing a molecular species that is well behaved at the metal surface. Unfortunately, not all molecules are as well behaved, and several we had difficulty acquiring reliable data at any concentration. The primary factor we found to most affect analyte signal quality was sampling method. Neat versus solutions, drop cast versus dipping, drying the solution on the sensing area versus leaving it wet, were all found to affect overall signal quality and by extension overall system sensitivity.

3) These initial studies provided guidance on how to engineer an integrated solution to SERs sampling (Figure 5). The proposed work focused on a cartridge based design that had a spool of SERs active material that could be drawn across the Raman sensing area, much like an audio cassette tape. However, this design proved exceedingly difficult to engineer as the SERs material is typically cast from a solution of polyaniline in n-methyl-2-pyrrolidone (NMP).

This solvent was too harsh for all plastic substrates we used to make the tape and typically dissolved everything nearly instantly. We moved away from flexible substrates and a tape design by looking at current sensing technologies that are widely in use. The easiest starting place is the glucose sensing stick. We created polyacrylic chips that could be used as a substrate to cast the polyaniline onto. This process worked very well, as the NMP tends to slightly dissolve the top layer of the acrylic, creating a strong bond between the polyaniline and the underlying substrate. We were able to successfully grow nanostructured metals on these films and provide a useful approach to reproducible sampling.

This novel polymer hybrid material opens many options for automated sampling. Initial designs involve a rotating carousel that indexes to the next SERs active substrate as the device rotates (similar to a viewfinder). Well plate designs are also an option for mass production as that could be laser machined out of acrylic with the SERs active material grown from the bottom of the well. This would open this technology to a wide range of combinatorial bioassay techniques as the well plates could be used for in-situ monitoring of entire arrays of chemical reactions.

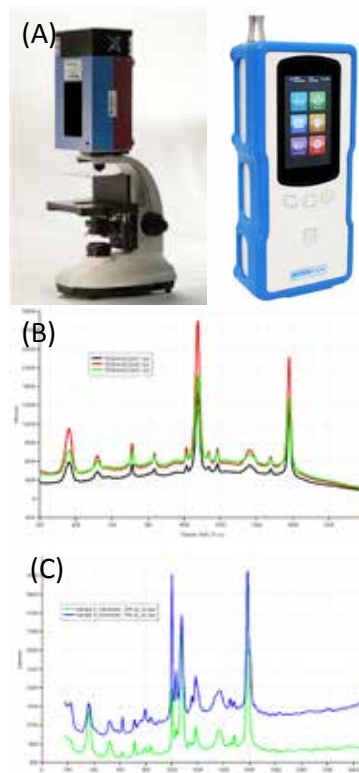

Figure 1. Portable raman spectrometers used in this work (A). Representative SERS spectra of mercaptobenzoic acid from each portable spectrometer used in this work.

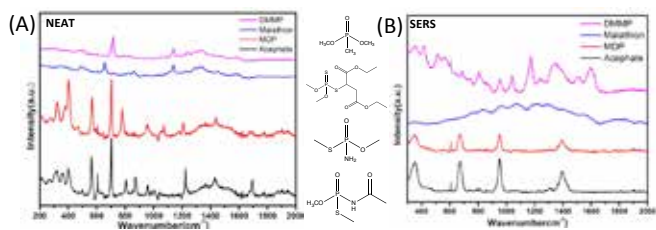

Figure 2. Representative spectra of various organophosphates using the Rigaku portable spectrometer. (A) Raman spectra of neat compound. (B) SERS spectra on metal substrates.

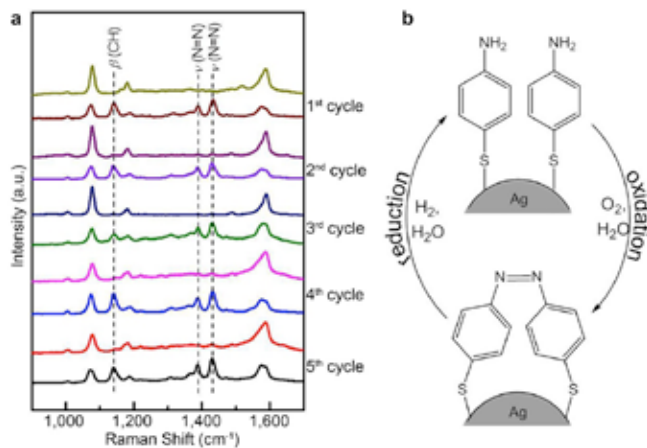

Figure 3. Observation of a reversible azo coupling reaction on the surface of a SERS active particle.

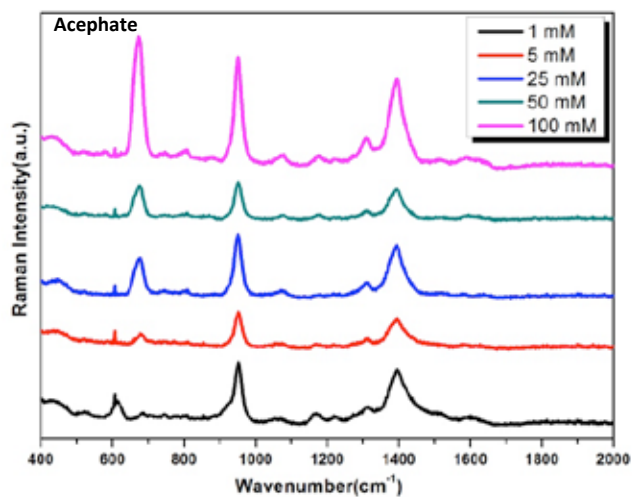

Figure 4. SERS spectra of aqueous acephate solutions at different concentrations.

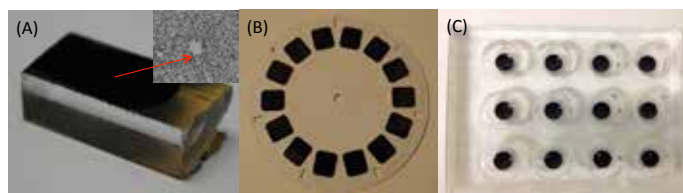

Figure 5. (A) Polyacrylic-polyaniline hybrid SERS substrate with an inset SEM image of SERS active metal particles on the surface. (B) Proposed turn table SERS sampler. (C) Demonstration SERS active multiwell plate.

Impact on National Missions

This work supports national efforts to detect and counteract weapons of mass destruction. Specifically, chemical weapons are a threat not only to military installations and personnel, but also to the general public. Unlike many more exotic WMDs, chemical weapons are relatively easy to manufacture, hard to detect, and have been actively used in recent history. Applying novel materials development to real world detection problems requires engineering efforts to take a laboratory experiment from the benchtop to a fieldable system. This work demonstrates the detection of CW simulants at relatively low levels (high sensitivity) and provides multiple options for a sampling platform by integrating with acrylic polymers.

Publications

- Kang, L. L., P. Xu, B. Zhang, H. H. Tsai, X. J. Han, and H. L. Wang. Laser wavelength- and power-dependent plasmon-driven chemical reactions monitored using single particle surface enhanced Raman spectroscopy. 2013. CHEMICAL COMMUNICATIONS. 49 (33): 3389.
- Kang, L. L., P. Xu, D. T. Chen, B. Zhang, Y. C. Du, X. J. Han, Q. Li, and H. L. Wang. Amino Acid-Assisted Synthesis of Hierarchical Silver Microspheres for Single Particle Surface-Enhanced Raman Spectroscopy. 2013. JOURNAL OF PHYSICAL CHEMISTRY C. 117 (19): 10007.
- Li, S. W., P. Xu, Z. Q. Ren, B. Zhang, Y. C. Du, X. J. Han, N. H. Mack, and H. L. Wang. Fabrication of Thorny Au Nanostructures on Polyaniline Surfaces for Sensitive Surface-Enhanced Raman Spectroscopy. 2013. ACS APPLIED MATERIALS & INTERFACES. 5 (1): 49.
- Park, Y. S., Y. Ghosh, P. Xu, N. H. Mack, H. L. Wang, J. A. Hollingsworth, and H. Htoon. Single-Nanocrystal Photoluminescence Spectroscopy Studies of Plasmon-Multiexciton Interactions at Low Temperature. 2013. JOURNAL OF PHYSICAL CHEMISTRY LETTERS. 4 (9): 1465.
- Park, Y. S., Y. Ghosh, Y. Chen, A. Piryatinski, P. Xu, N. H. Mack, H. L. Wang, V. I. Klimov, J. A. Hollingsworth, and H. Htoon. Super-Poissonian Statistics of Photon Emis-

sion from Single CdSe-CdS Core-Shell Nanocrystals Coupled to Metal Nanostructures. 2013. PHYSICAL REVIEW LETTERS. 110 (11): -.

Xu, P., L. Kang, N. H. Mack, K. S. Schanze, X. Han, and H. Wang. Mechanistic understanding of surface plasmon assisted catalysis on a single particle: cyclic redox of 4-aminothiophenol. 2013. Scientific reports. 3.

Xu, P., X. Han, B. Zhang, Y. Du, and H. Wang. Multifunctional polymer-metal nanocomposites via direct chemical reduction by conjugated polymers. 2014. Chemical Society Reviews. 43 (5): 1349.

Determining Physiological Predictors of Climate-driven Forest Mortality

Nathan G. McDowell
20110756PRD4

Introduction

We propose to determine which, if any, common physiological responses during heat and drought-driven mortality exist at a global scale, and thus determine the simplest but strongest predictors of tree mortality across different species of trees. The experiments to determine these common predictors will be conducted on trees of multiple scales; from seedlings to >100 year old trees. Through the process, we will identify the final steps in mortality and survival, allowing modelers to simplify not only their prediction of stress but of the key aspects of plant physiology that partition plants between survival and death during drought. The final product(s) will identify the simplest, most common, and statistically strongest environmental and physiological predictors of mortality, and interpretation of their mechanisms.

Benefit to National Security Missions

The goal of this research will be to develop a bridge between physiology and modeling by identifying the simplest level of detail needed to predict tree drought mortality across multiple forest types. This work directly supports DOE's Climate and Environmental Science Division goals to understand the role of terrestrial ecosystems in a changing climate and is intended to promote long-term programmatic growth in this arena. Specifically the products of this research will be directly tailored for incorporation into DOE's Community Land Model. Addressing this key gap for coupled vegetation-climate models could lead to the rapid development of more accurate global change projections that are urgently needed to inform sound climate policy at a global level.

Progress

In the past 12 months Dr Adams has been amazingly productive. He has collected all of the data for at least two manuscripts from a field experiment at LANL examining forest mortality, which he is now putting together into manuscript format. He has also initiated data col-

lection for a meta-analysis of forest mortality patterns. This collection is being done via networking with a large number of scientists. More than two-thirds of the data is now in Dr Adams's possession. Lastly, Dr Adams is working closely with our modelers to learn from them the key aspects for modeling mortality and to feed them information regarding how to model tree death. This is a component of a follow on paper that Dr Adams is working on. Dr. Adams is well on his way to a very productive career at Los Alamos.

Future Work

Dr. Adams will continue to collaborate with EES staff, post-docs, and students who are working on the Los Alamos Survival Mortality (SUMO) project to collect data on key physiological responses to drought through mortality in pinyon pine and juniper trees. Dr. Adams will continue to lead two sampling efforts at SUMO: 1.) to monitor stressed trees for insect attack and characterize tree defensive capabilities against insects at this experiment; 2.) repeated measurement of inherent hydraulic vulnerability to assess if functional tree water stress relationships change with drought and increased temperature. Dr. Adams will continue a SUMO supplemental experiment initiated in FY13 aimed at distinguishing the physiological threshold of survival and mortality using transplanted trees in the greenhouse at TA-51. The protocol of this experiment will be to drought stress sets of trees to hypothesized thresholds of survival, and then re-water these trees, measuring physiological responses and critically, whether the trees ultimately die or survive when re-watered. This experiment is aimed at elucidating the simplest key thresholds between tree mortality and survival that can be incorporated into mechanistic and predictive models of tree mortality. These data will inform ongoing modeling efforts by EES staff to address DOE's Climate and Environmental Science Division goals to understand the role of terrestrial ecosystems in a changing climate. Specifically, data from this experiment

will be used to parameterize tree mortality routines in DOE's Community Land Model.

Conclusion

Dr. Adams will develop a bridge between physiology and modeling by identifying the simplest level of detail needed to predict tree drought mortality across forest types. This work supports DOE's Climate and Environmental Science Division goals to understand the role of terrestrial ecosystems in a changing climate. Specifically the products of this research will be directly tailored for incorporation into DOE's Community Land Model. Addressing this key gap for coupled vegetation-climate models could lead to the rapid development of more accurate global change projections that are urgently needed to inform sound climate policy at a global level.

Publications

- Adams, H., and e. al. Empirical and process-based approaches to climate-induced forest mortality models. To appear in *Frontiers in Plant Science*.
- Adams, T., and e. al. Nonstructural leaf carbohydrate dynamics of *Pinus edulis* during drought-induced tree mortality reveal role for carbon metabolism in mortality mechanism. 2013. *New Phytologist*. : 1142.
- Breshears, D., H. Adams, and e. al. The critical amplifying role of increasing atmospheric moisture demand on tree mortality and associated regional die-off. . 2013. *Frontiers in Plant Science*. 4: 266.
- Franz, T., and e. al. Ecosystem-scale measurements of biomass water using cosmic ray neutrons. . 2013. *Geophysical Research Letters*. : 3929.
- Zeppel, M., and e. al. Forest mortality due to drought: latest insights, evidence and unresolved questions on physiological pathways and consequences of tree death. 2013. *New Phytologist*. : 372.

Catalytic Mechanism and Inhibition of Metallo-beta-lactamases (MBL), the Ultimate Threat Against Antibiotics

Suzanne Z. Fisher
20120776PRD4

Introduction

The proposed work will utilize an innovative research strategy that is LANL-unique for novel antibiotics. We will combine neutron and X-ray diffraction to obtain high resolution structures and detailed information on how metallo beta-lactamases (MBLs) work to degrade clinically used antibiotics. Due to their readiness for horizontal transfer and evolution, MBLs entail a serious public health threat, with increasing antibiotic resistance found all over the world. Results will have direct implications for not only understanding how these enzymes work, but also to enable the design of clinically useful antibiotics not susceptible to breakdown by these harmful enzymes.

Benefit to National Security Missions

Metallo beta lactamases comprise a serious human health issue due to the innumerable complications associated with untreatable infections caused by some of the most dangerous bacteria present in clinical settings and intensive care units. This work, which can only be performed at LANL's world-class facilities, will provide the first neutron structures for antibiotic resistance enzymes found in multidrug resistant pathogens. This work will advance our basic understanding of enzyme mechanisms and drug binding. Neutron diffraction is underutilized for drug design and is the only technique that can give unique data on drug binding and degradation. This work may lead to novel compounds that will have an enormous impact on human health and disease.

We also envision a scenario where detection methods can be developed to find bacteria expressing resistance genes in the environment. This work directly addresses mission relevance in the fields of basic health research, bioscience, and pathogen detection.

Progress

Javier was able to obtain high quality clones of two dif-

ferent metallo-beta-lactamases, BcII and NDM. These seems to express well and having enough protein is the first crucial step for neutron studies. We were also able to crystallize one of these enzymes, BcII, at pH 7, which is more physiologically relevant than other reported structures at pH 4.5 and 6.

For NDM, the enzyme found in deleterious antibiotic-resistant pathogens, we designed and produced two double mutants that is unable to bind the second catalytic zinc in the active site. Instead we have populated these sites with alkaline earth metals magnesium and calcium. This allows us to bind antibiotics in the active site, but stops hydrolysis and allows us to study the binding mechanism. We are also optimizing conditions for large crystal growth for neutron studies of these variants.

To study the basic binding interactions and to investigate new possible lead compounds, we have co-crystallized sulfonamide drugs with both BcII and NDM. We are working on determining X-ray crystal structure to confirm binding. In progress also is co-crystal structures of BcII and NDM in complex with Aztreonam, the only known antibiotic that is still able to resist hydrolysis by these enzymes.

We are ready to progress to the next phase, the in vitro evolution of NDM to determine which active site mutations confers the ability to hydrolyze Aztreonam. This will deliver an early detection system for real world diagnostic application. We are working on permission and authorization to perform this work in a Biosafety Level 2 lab.

Future Work

For the second year, we are working towards determining X-ray and neutron structures of BcII and/or NDM-1 (wild type and mutants) with different active site metals. We have designed the appropriate expression plasmids

and have made enzymes with non-native metals in the active site. This will allow binding of antibiotics, but will prevent hydrolysis allowing us to study the binding interactions with the enzyme.

We will also pursue complexes with existing antibiotics to investigate binding and the enzyme residues that are involved with catalysis. Neutron crystallography, which will shed light on the H-bond networks in the active site, will facilitate this detailed investigation of drug binding and involvement of water activation.

We are pursuing sulfonamide-based drugs as lead compounds and are making complexes between these drugs and BclI and/or NDM-1. Sulfonamides are known to bind to other Zn-containing enzymes and we will pursue them here also.

Conclusion

We will characterize the enzyme NDM-1: (1) Water activation, (2) Substrate binding, (3) In vitro evolution. (1) we will solve the structure of NDM-1 through neutron crystallography, which will shed light on the H-bond networks in the active site. (2) we will engineer NDM-1 to enable binding alkali earth metals in the second Zn(II) site. This will eliminate enzyme activity while retaining substrate binding for structural analysis. (3) we will construct NDM-1 mutant libraries, which will be screened for resistance to monobactams. Mutants will be selected and analyzed to understand the structural traits of enzymes with broad substrate preferences.

Single Cell Genomics for Better Control of Plant Pathogens

Shunsheng Han
20130779PRD1

Introduction

The proposed research will use the rhizosphere-colonizing bacterium *Pseudomonas chlororaphis* strain 30-84. The strain is able to inhibit fungal pathogens and has become a model for a beneficial commensal bacterium. This strain demonstrates phenotypic variation resulting from spontaneous mutations. The goal of this research is to identify signature genomic and transcriptomic changes in response to environmental signals and investigate how these changes benefit the wild type populations using a plant associated bacterial as example.

Benefit to National Security Missions

The understanding of the relationship between plant and bacteria is directly linked to the DOE mission in the area of bioenergy. LANL, supported by DOE, has invested significantly in studying plant metabolism and algal biofuel. This work will enrich our portfolio in these areas and bridge the gaps between environmental microbiology and plant study.

Progress

The postdoc fellow Dongping Wang started on June 10, 2013. For the last 17 days, he has completed many required training courses including the General employee training. Many other trainings such as biosafety and laser training have been scheduled in July and August. Some experimental materials have arrived at the lab. Bacterial strains will be shipped from Texas A&M University once they are approved by the Institutional Biosafety Committee at Los Alamos National Laboratory.

We made an experimental plan for next fiscal year and will perform the following experiments to fulfill the aims of the proposed research:

- To identify mutational events during *P. chlororaphis* rhizosphere colonization, bacterial cells will be inoculated on plant roots. Bacterial spontaneous

mutants will be isolated by both visual observation and flow cytometry sorting.

- Bacterial genome sequencing will be performed in Dr. Cliff Han's lab using the cutting edge sequencing platform and gel microdroplet culturing technology. Mutational events will be identified by comparing to a published wild type *P. chlororaphis* genome.
- To understand the roles of these genomic changes in bacterial persistence, mutant strains will be compared with the wild type to determine their ability to control fungal pathogens and form biofilms.
- We will also perform transcriptomic analysis to identify differentially regulated genes in the mutants compared with the wild type. Selected target genes will be further investigated using functional genomics tools such as gene deletion and over-expression.

These studies will provide a comprehensive view of bacterial genomic changes/cell differentiation during host association. The results will aid in designing new strategies in plant disease control.

Future Work

We will perform the following experiments to fulfill the aims of the proposed research:

- To identify mutational events during *P. chlororaphis* colonization, bacterial cells will be inoculated on plant roots. Flow cytometry will be used to determine the bacterial size and sort them into different groups.
- Single cell genome will be sequenced using gel microdroplet culturing in Dr. Cliff Han's group. Beneficial mutations will be identified by comparing with a published wild type genome sequence. These results will provide us with a complete set of mutations that are involved in host association.

-
- To study the role of these genomics changes in bacterial persistence, beneficial mutants will be compared with the wild type strain in their ability to produce fungal-inhibiting metabolites and form biofilms.
 - Genomic mutations may lead to changes in gene expression. To understand the beneficial mutation at the transcriptome level, RNA sequencing will be conducted to identify differentially expressed genes between wild type and beneficial mutant strains. Together, these data will give us a comprehensive understanding of cell differentiations in response to environmental signals.
 - The above analysis will identify candidate genes involved in disease control. Selected genes will be investigated using functional genomic approaches.

Conclusion

We expect to identify mutational events during *P. chlororaphis* colonization, to classify and identify the beneficial mutation that are involved in host association. We will also identify the role of these genomic changes in bacterial persistence. Understanding of molecular processes involved in bacterial adaptation could lead to better disease management strategies.

Publications

Wang, D., C. Han, C. Lo, A. Dichosa, P. Chain, J. M. Yu, L. S. Pierson, and E. A. Pierson. Genomic adaptations of a small colony variant (SCV) in the biofilm of *Pseudomonas chlororaphis* 30-84. *Genome Biology and Evolution*.

Joint Inversions of Seismic and Gravity Data in Volcanic Areas to Advance Hazards Assessment: A Focus on the Alaskan Subduction Zone and Kilauea, Hawaii

Monica Maceira
20130807PRD3

Introduction

Three-dimensional passive-source seismic velocity tomography is a powerful technique that utilizes energy produced by earthquakes to image potentially complex subsurface structures, such as magma distributions beneath volcanoes or subducting slabs. However, the resolution of these studies are generally limited by the natural distribution of earthquakes. While active sources can expand coverage, they are generally only used to image the upper crust and are costly. Gravity data, however, provide alternate sources of information regarding subsurface structures, and are available at a variety of scales. Due to the inherent relationship between density and seismic velocity, gravity and seismic data can be jointly inverted, providing an understanding of Earth structures that is not limited by the distributions of seismicity and has stronger constraints on the temperature, compositional, fluid, and magmatic distributions in a study area.

The current distribution of seismic stations in Alaska is focused near the relatively two-dimensional volcanic arc located above the subducting oceanic plate, limiting the ability to resolve its seismic structure. The inclusion of gravity data in a joint inversion will markedly increase the ability to resolve these features in three dimensions. I will address questions regarding the sources of volcanism in the Alaska subduction zone.

Kilauea Volcano presents a unique opportunity to study one of Earth's most active volcanoes, in a location that has produced historical tsunamigenic earthquakes. While previous seismic studies have focused on studying the near-surface beneath the summit caldera, portions of Kilauea's rift zones, or the seismically active tsunamigenic decollement fault beneath the volcanic material and the underlying oceanic crust, the extents of these studies are limited by the natural seismic distributions. By combining gravity and seismic data, I will address questions such as "Can the aseismic and seismic portions

of the decollement be imaged, constraining the maximum magnitude of earthquake this fault can produce?"

Benefit to National Security Missions

The proposed research will enhance the capability of the Laboratory through unique expertise in imaging Earth structure. This expertise has applications to Nonproliferation R&D under Nuclear Nonproliferation, where accurate Earth models are needed to locate, identify and determine yield for seismic events of interest such as underground nuclear explosions. High-resolution Earth models are also required for characterization and monitoring within several other areas of LANL mission space including geothermal energy development (Applied Energy Programs Office) carbon sequestration (Fossil Energy, within the Office of Science Programs), and used fuel disposition and salt repository science (both within the office of Civilian Nuclear Programs).

Progress

This project had just started at the time of this report; therefore, there is no progress to date.

Future Work

I will simultaneously invert two different data types to derive the Earth's 3D velocity structure beneath the Alaska subduction zone and the Kilauea volcano, Hawaii. Seismic data will come from local, regional, and national networks and deployments, while gravity data will come from US satellite missions as well as in-land measurements. The research paths will be as follows: (1) develop code for efficient and robust multi-parameter inversion, (2) gather and pre-process the different data types, and (3) perform multi-parameter inversion to produce a validated high resolution high accuracy 3-D velocity image of the Alaska subduction zone and the Kilauea volcano, Hawaii.

The first year, focus will be on code development and

the Kilauea volcano, Hawaii, where seismic and gravity data are readily available. The expansion of USArray seismic stations to Alaska in the coming year will allow seismic models to be significantly improved during the second year of this project.

Conclusion

The expected results from the research are: I. Development of the next-generation method for imaging the 3-D structure of the Earth and, II. A high-resolution high-accuracy 3-D velocity image of the crust and upper mantle beneath the Alaska subduction zone and the Kilauea volcano. I expect to submit two papers to high-impact journals, one for each of the regions of interest, and addressing the scientific questions stated in the abstract.

Measurement of Orthogonal Velocity Components using Photon Doppler Velocimetry

Matthew E. Briggs
20120771PRD4

Abstract

In the last decade, photon Doppler velocimetry (PDV) has gained popularity as a primary diagnostic in experiments (explosive, shock physics, etc.) where velocities up to several kilometers per second need to be measured robustly and accurately. In PDV, a laser illuminates a region on the target surface, and the surface's velocity along the laser beam axis at the region of illumination is measured. As with any method of coherent illumination, the backscatter from the surface contains bright and dark regions, which are commonly referred to as "speckle".

Measured PDV data are routinely subject to dropouts (a loss of the signal) as a consequence of laser speckle. Thus, speckle has historically been viewed as nothing more than a hindrance, in the context of PDV data analysis. However, since the invention of the laser, various research efforts have sought to relate measured speckle dynamics to the dynamic response of the target surface. In this report, we summarize our progress in applying an understanding of speckle dynamics to PDV data analysis. Specifically, we demonstrated that speckle dynamics contain information about the surface dynamics, and when treated properly, they inform the PDV data analyst of the target surface's motion perpendicular to the laser beam (a dimension of motion that is not available via traditional PDV velocity extraction). This contribution makes it possible for a single PDV probe to simultaneously measure motion along its beam axis (utilizing the frequency analyses that are typical for PDV) and perpendicular to its beam axis (utilizing speckle analyses). We characterized the relationships between the measurement probe's focusing properties and the resulting speckle dynamics, and we demonstrated that previous models fail to describe the speckle dynamics that are experimentally observed when the target surface is near the probe's focal plane (a condition that is practically guaranteed when PDV is fielded).

Background and Research Objectives

Speckle is the result of constructive and destructive interference between the reflections at neighboring surface features [1]. Therefore, speckle arises when a coherent source (e.g., a laser beam) illuminates a surface whose roughness is large compared to the illuminating wavelength (wavelengths of about 1550 nanometers are typical for PDV). The speckle pattern reflected by a particular region on a surface is a random-but-fixed property of that surface. Consequently, it seems logical that the dynamics of a changing speckle pattern may be related to some degree to the dynamics of the surface under illumination. Previous researchers developed theoretical formulations that relate speckle dynamics to surface motion, and they used these relationships to extract surface speeds of up to one meter per second from measured speckle dynamics [2]-[3]. Although this previous research provided a starting point for our project, the application of these results to PDV necessitated a few, key changes. Firstly, in comparison to these previously published results, PDV is used to measure velocities that are orders of magnitude faster (several kilometers per second, compared to one meter per second) with signal to noise ratios that are much lower. Secondly, these previous experimental setups employed one laser (whereas PDV requires heterodyning, or the mixing of two laser beams) and separated the transmission and measurement planes (PDV uses a single optical probe to transmit and measure the laser beam). Prior to the start of this research project, it was not obvious how these changes would affect the performance of any speckle velocimetry that we applied to PDV data.

Our first primary objective was to apply the previously developed speckle velocimetry tools to PDV, to determine whether or not qualitative relationships between surface speed and speckle dynamics could be observed. Since laser speckle occurs in PDV measurements, regardless of whether or not it is desirable, this objective sets out to exploit free information that is already present

in the PDV data, without necessitating any hardware or system-level changes. Upon succeeding, our second primary objective was to quantify these relationships, so that actual surface speeds could be calculated from speckle dynamics, with some quantified degree of uncertainty. As part of this effort, we characterized the influence of probe selection (specifically, the focusing properties of the probe in use) on the resulting speckle dynamics, to determine whether or not there existed an ideal probe-type for making these measurements. We succeeded in achieving both of these primary objectives, as will be discussed in the next section of this report.

Note, that explosive tests often result in surface evolution (e.g., strain or fracture, in addition to surface translation), and to the best of our knowledge, no one has related the dynamics of a straining surface to the dynamics of the measured speckle pattern in a quantitative way. Once we succeeded in quantitatively relating speckle dynamics to surface motion using PDV, we set out to describe the relationships between speckle dynamics and the evolution of a straining surface. This follow-on objective, which was not part of the original project proposal, was partially addressed, but bringing it to completion would require additional sources of funding for experimental design and execution and for ongoing theoretical development.

Scientific Approach and Accomplishments

We succeeded in achieving our two primary objectives. We used simple, one-dimensional rigid-body translation experiments to relate surface velocities to speckle dynamics, as they are measured by a PDV system. In doing so, we were able to qualitatively and quantitatively validate previous models for speckle dynamics, as they apply to particular regions of the parameter space (e.g., far from the optical probe's focal plane), for a PDV setup. This resulted in the first demonstration of an optical diagnostic, wherein a single measurement beam simultaneously measured the velocity of a surface along its beam and the speed of a surface perpendicular to its beam (these experiments and results are described in more detail in the following journal publication: Moro and Briggs *Rev. Sci. Instrum.* 2013). We performed a quantitative comparison of different signal features, in order to establish those features that offer the best performance in speckle velocimetry. We determined that the coherence time, a property that is calculated from the autocorrelation of the speckle data and describes the decorrelation of a speckle pattern with itself, outperforms other signal features in relating speckle dynamics to surface dynamics (this analysis is described in more detail in the following conference paper: Moro, Briggs, and Hull *Proc. IEEE* 2013). After demonstrating that this technique works in specific regions of the parameter space (specifi-

cally, far from the optical probe's focal plane), we characterized the measured speckle dynamics as the surface moves through the focal plane of the probe in use (this is described in more detail in the following journal publication: Moro, Briggs, and Hull *Appl. Opt.* 2013). We demonstrated experimentally that the speckle coherence time, the signal feature that we selected for relating speckle dynamics to surface dynamics, is a nonlinear function of the surface's position and is highly sensitive to changes in the surface position near the focal plane. This is a key finding, since PDV experiments are most often set up in such a way that the optical probes measure a surface as it moves through their respective focal planes.

We performed a suite of explosive tests to investigate the relationships between the strain behavior of evolving surfaces and the measured speckle dynamics. We demonstrated that the coherence time of the dynamic speckle has definite, repeatable structure that quantitatively relates to the straining surface, although this research is ongoing (these experiments and observations are described in more detail in the following test report: Moro, Briggs, and Hull *Los Alamos National Laboratory Authors Database* 2013).

Impact on National Missions

As stated in the Abstract, PDV has gained increasing popularity as a primary diagnostic in tests across the Department of Energy Complex. As testament to this fact, the development of multiplexed PDV (or MPDV) by researchers at National Security Technologies, LLC and Los Alamos and Lawrence Livermore National Laboratories were acknowledged with a prestigious R & D 100 Award in 2012. Given our success in achieving the stated objectives, and given the widespread interest in using PDV within the Departments of Energy and Defense, presentations on this research have been enthusiastically received in a variety of settings (internal, scientific conference, TCG, etc.). Our progress in characterizing and understanding speckle dynamics contributes to the overall understanding of what PDV measures and how it interacts with the target surface in complex ways. The speckle velocimetry tools we developed do not require any hardware or system-level changes to implement, and they may therefore be applied to the data sets generated by past, ongoing, or future experiments, to inform the analyst about the surface's dynamic response. This additional information informs the simulations of these experiments, and allows us to better understand the dynamic response of materials under test.

Note, that we collaborated with the Fourteenth Los Alamos Dynamics Summer School (hosted annually by the Los Alamos National Laboratory's National Security Education

Center), inviting a team of three undergraduate engineering students to work on research in support of this project for a two-month period. This collaboration resulted in a conference publication (Warren et al. Proc. IMAC 2014), and Will Warren, one of the undergraduate summer students, expressed interest in continuing to work on this project. In September 2013, we successfully converted Will to a Post-Baccalaureate position in WX-4, and he continues to perform research that is pertinent to this project.

References

1. Goodman, J. W.. Origins and manifestations of speckle. 2007. In *Speckle phenomena in optics.* , first Edition, p. 1. Greenwood Village, CO: Roberts & Co..
2. Iwai, T., N. Takai, and T. Asakura. Dynamic statistical properties of laser speckle produced by a moving diffuse object under illumination of a Gaussian laser beam. 1982. *Journal Optical Society of America.* 72: 460.
3. Fercher, A. F.. Velocity measurement by first order statistics of time-differentiated laser speckles. 1980. *Optics Communications.* 33: 129.

Publications

- Briggs, M., D. Knierim, E. Moro, and S. McGrane. Optical distance measurements to recover the material approach missed by optical velocimetry. 2014. In *Shock Compression of Condensed Matter.* (Seattle, July 2013). , p. 142005. Philadelphia: IOP publishing.
- Hull, L. M., M. E. Briggs, and E. A. Moro. The effect of tangential velocity components and surface evolution on photon Doppler velocimetry measurements. 2013. Los Alamos National Laboratory Report.
- MORO, E. A.. New Developments in photon Doppler velocimetry. 2104. In *Shock Compression of Condensed Matter.* (Seattle, July, 2013). , p. 1742. Philadelphia: IOP publishing.
- Moro, E. A.. Extracting transverse motion from speckle dynamics in photon Doppler Velocimetry. Presented at Postdoc Research Day at Los Alamos National Laboratory. (Los Alamos, 2013).
- Moro, E. A., M. E. Briggs, and L. M. Hull. Defining parametric dependencies for the correct interpretation of speckle dynamics in photon Doppler velocimetry. 2013. *Applied Optics.* 52 (36): 8661.
- Moro, E. A., M. E. Briggs, and L. M. Hull. A comparison of techniques for extracting transverse speed from photon Doppler velocimetry signal content. 2013. In *IEEE Sensors.* (Baltimore, 2013). , p. 1. Baltimore: IEEE.

Moro, E. A., M. E. Briggs, and L. M. Hull. "H4442, H4442 Test Report: Surface evolution of radially expanding cylinders and the measured response in photon Doppler velocimetry. 2013. Los Alamos National Laboratory.

Moro, E. A., and M. E. Briggs. Note: Simultaneous measurement of transverse speed and axial velocity from a single optical beam. 2013. *Review of Scientific Instruments.* 84: 016110.

Moro, E. A., and M. E. Briggs. Extracting transverse motion from speckle dynamics in photon Doppler velocimetry. Presented at 2013 Nuclear Explosives Design Physics Conference. (Livermore, January, 2014).

Moro, E. A., and M. E. Briggs. Extracting lateral motion from the dynamic amplitude modulations-the dynamic speckle-of a PDV signal. 2012. In *2012 PDV Workshop at Sandia National Laboratory.* (Albuquerque, 2012). , p. 1. Columbus: Ohio State University.

Warren, W. J., L. Ott, E. Elmore, E. A. Moro, and M. E. Briggs. Laser speckle dynamics sensing applications. 2014. In *IMAC-XXXII.* (Orlando, 2014). Vol. II, p. 341. New York: Springer.

Laboratory Directed Research & Development
Los Alamos National Laboratory
PO Box 1663, MS M708
Los Alamos, NM 87545
505-667-1235 (phone)